

Super-precision bearings

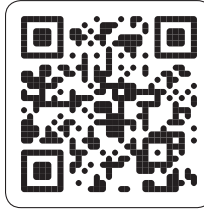

SKF mobile apps

SKF mobile apps are available from both Apple App Store and Google Play. These apps provide useful information and allow you to make critical calculations, providing SKF Knowledge Engineering at your fingertips.



Apple AppStore



Google Play

© SKF, BeyondZero, KMT and KMTA are registered trademarks of the SKF Group.

™ NitroMax is a trademark of the SKF Group.

Apple is a trademark of Apple Inc., registered in the US and other countries.

Google Play is a trademark of Google Inc.

© SKF Group 2014

The contents of this publication are the copyright of the publisher and may not be reproduced (even extracts) unless prior written permission is granted. Every care has been taken to ensure the accuracy of the information contained in this publication but no liability can be accepted for any loss or damage whether direct, indirect or consequential arising out of the use of the information contained herein.

PUB BU/P1 13383/1 EN · May 2014

This publication supersedes publication 6002.

Certain image(s) used under license from Shutterstock.com

Principles of bearing selection and application

1

Angular contact ball bearings

2

Cylindrical roller bearings

3

Double direction angular contact thrust ball bearings

4

Axial-radial cylindrical roller bearings

5

Angular contact thrust ball bearings for screw drives

6

Precision lock nuts

7

Gauges

8

Indexes

9

Content

This is SKF	6
SKF – the knowledge engineering company	8
Unit conversions	10
Foreword	11
1 Principles of bearing selection and application	19
Selecting super-precision bearings	20
Bearing types and designs	21
Basic selection criteria	23
Bearing life and load ratings	33
Dynamic bearing loads and life	33
Permissible static loads	36
Friction	37
Effects of clearance and preload on friction	37
Effects of grease fill on friction	37
Frictional behaviour of hybrid bearings	37
Speeds	38
Permissible speeds	39
Attainable speeds	44
Attainable speeds for typical spindle bearing systems	44
Bearing specifics	46
Boundary dimensions	46
Tolerances	47
Preload and internal clearance	50
Materials	51
Design considerations	57
Bearing arrangements	57
System rigidity	66
Radial location of bearings	70
Axial location of bearings	78
Provisions for mounting and dismounting	88
Bearing preload	90
Sealing solutions	95
Lubrication	99
Grease lubrication	99
Oil lubrication	113
Lubricant storage	122

Mounting and dismounting	123
Where to mount	123
Methods and tools	123
Mounting recommendations	123
Test running	124
Dismounting	124
Reusing bearings	124
SKF spindle service	125
Bearing storage	125
2 Angular contact ball bearings	127
Assortment	128
Designs and variants	128
Bearing arrangement design	141
Markings on bearings and bearing sets	145
Bearing data	146
Preload	151
Axial stiffness	173
Fitting and clamping bearing rings	183
Load carrying capacity of bearing sets	189
Equivalent bearing loads	190
Attainable speeds	192
Mounting	194
Designation system	196
Product table	
2.1 Angular contact ball bearings	198
3 Cylindrical roller bearings	263
Designs and variants	264
Bearing data	269
Radial internal clearance or preload in mounted bearings	275
Radial stiffness	275
Equivalent bearing loads	277
Attainable speeds	277
Design considerations	278
Mounting	280
Designation system	286
Product tables	
3.1 Single row cylindrical roller bearings	288
3.2 Double row cylindrical roller bearings	294
4 Double direction angular contact thrust ball bearings	301
Designs and variants	302
Markings on bearings	305
Bearing data	306
Preload	308
Axial stiffness	309
Equivalent bearing loads	310
Attainable speeds	310
Mounting	310
Designation system	311
Product table	
4.1 Double direction angular contact thrust ball bearings	312

Content

5 Axial-radial cylindrical roller bearings	319
Designs and variants	320
Bearing data	321
Preload and stiffness	322
Friction	322
Lubrication	324
Design considerations	324
Load carrying capacity	327
Equivalent bearing loads	327
Permissible moment load	328
Mounting	330
Designation system	333
Product tables	
5.1 Axial-radial cylindrical roller bearings	334
6 Angular contact thrust ball bearings for screw drives	337
Designs and variants	338
Bearing arrangement design	346
Markings on bearings	352
Bearing data	353
Preload	355
Axial stiffness	358
Frictional moment	360
Lifting force	360
Load carrying capacity of bearing sets	361
Equivalent bearing loads	361
Axial load carrying capacity	362
Mounting	362
Attainable speeds	363
Designation system	364
Product tables	
6.1 Single direction angular contact thrust ball bearings	366
6.2 Double direction angular contact thrust ball bearings	368
6.3 Double direction angular contact thrust ball bearings for bolt mounting	370
6.4 Cartridge units with a flanged housing	372
7 Precision lock nuts	375
Designs	376
Product data	378
Installation and removal	379
Designation system	382
Product tables	
7.1 KMT precision lock nuts with locking pins	384
7.2 KMTA precision lock nuts with locking pins	386
7.3 KMD precision lock nuts with axial locking screws	388

8 Gauges	391
GRA 30 ring gauges	393
Product table	
8.1 GRA 30 ring gauges	394
DMB taper gauges	396
Product table	
8.2 DMB taper gauges	398
GB 30 and GB 10 internal clearance gauges	400
Product tables	
8.3 GB 30 and GB 10 internal clearance gauges for cylindrical roller bearings	402
GB 49 internal clearance gauges	404
Product tables	
8.4 GB 49 internal clearance gauges for cylindrical roller bearings	406
9 Indexes	408
Text index	409
Product index	420

This is SKF

From one simple but inspired solution to a misalignment problem in a textile mill in Sweden, and fifteen employees in 1907, SKF has grown to become a global industrial knowledge leader. Over the years, we have built on our expertise in bearings, extending it to seals, mechatronics, services and lubrication systems. Our knowledge network includes 46 000 employees, 15 000 distributor partners, offices in more than 130 countries, and a growing number of SKF Solution Factory sites around the world.



Research and development

We have hands-on experience in over forty industries based on our employees' knowledge of real life conditions. In addition, our world-leading experts and university partners pioneer advanced theoretical research and development in areas including tribology, condition monitoring, asset management and bearing life theory. Our ongoing commitment to research and development helps us keep our customers at the forefront of their industries.



SKF Solution Factory makes SKF knowledge and manufacturing expertise available locally to provide unique solutions and services to our customers.

Meeting the toughest challenges

Our network of knowledge and experience, along with our understanding of how our core technologies can be combined, helps us create innovative solutions that meet the toughest of challenges. We work closely with our customers throughout the asset life cycle, helping them to profitably and responsibly grow their businesses.

Working for a sustainable future

Since 2005, SKF has worked to reduce the negative environmental impact from our operations and those of our suppliers. Our continuing technology development resulted in the introduction of the SKF BeyondZero portfolio of products and services which improve efficiency and reduce energy losses, as well as enable new technologies harnessing wind, solar and ocean power. This combined approach helps reduce the environmental impact both in our operations and our customers' operations.



Working with SKF IT and logistics systems and application experts, SKF Authorized Distributors deliver a valuable mix of product and application knowledge to customers worldwide.



SKF – the knowledge engineering company

Our knowledge – your success

SKF Life Cycle Management is how we combine our technology platforms and advanced services, and apply them at each stage of the asset life cycle, to help our customers to be more successful, sustainable and profitable.

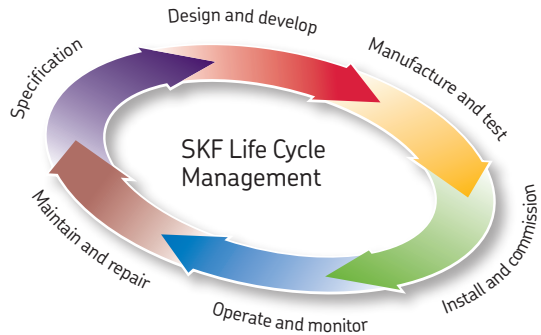

Working closely with you

Our objective is to help our customers improve productivity, minimize maintenance, achieve higher energy and resource efficiency, and optimize designs for long service life and reliability.

Innovative solutions

Whether the application is linear or rotary or a combination, SKF engineers can work with you at each stage of the asset life cycle to improve machine performance by looking at the entire

application. This approach doesn't just focus on individual components like bearings or seals. It looks at the whole application to see how each component interacts with each other.

Design optimization and verification

SKF can work with you to optimize current or new designs with proprietary 3-D modelling software that can also be used as a virtual test rig to confirm the integrity of the design.



Bearings

SKF is the world leader in the design, development and manufacture of high performance rolling bearings, plain bearings, bearing units and housings.



Machinery maintenance

Condition monitoring technologies and maintenance services from SKF can help minimize unplanned downtime, improve operational efficiency and reduce maintenance costs.



Sealing solutions

SKF offers standard seals and custom engineered sealing solutions to increase uptime, improve machine reliability, reduce friction and power losses, and extend lubricant life.



Mechatronics

SKF fly-by-wire systems for aircraft and drive-by-wire systems for off-road, agricultural and forklift applications replace heavy, grease or oil consuming mechanical and hydraulic systems.



Lubrication solutions

From specialized lubricants to state-of-the-art lubrication systems and lubrication management services, lubrication solutions from SKF can help to reduce lubrication related downtime and lubricant consumption.



Actuation and motion control

With a wide assortment of products – from actuators and ball screws to profile rail guides – SKF can work with you to solve your most pressing linear system challenges.

Unit conversions

Unit conversions					
Quantity	Unit	Conversion			
Length	inch	1 mm	0.03937 in.	1 in.	25,40 mm
	foot	1 m	3.281 ft.	1 ft.	0,3048 m
	yard	1 m	1.094 yd.	1 yd.	0,9144 m
	mile	1 km	0.6214 mi.	1 mi.	1,609 km
Area	square inch	1 mm ²	0.00155 sq-in	1 sq-in	645,16 mm ²
	square foot	1 m ²	10.76 sq-ft	1 sq-ft	0,0929 m ²
Volume	cubic inch	1 cm ³	0.061 cu-in	1 cu-in	16,387 cm ³
	cubic foot	1 m ³	35 cu-ft	1 cu-ft	0,02832 m ³
	imperial gallon	1 l	0.22 gallon	1 gallon	4,5461 l
	US gallon	1 l	0.2642 US gallon	1 US gallon	3,7854 l
Speed, velocity	foot per second	1 m/s	3.28 ft/s	1 ft/s	0,30480 m/s
	mile per hour	1 km/h	0.6214 mph	1 mph	1,609 km/h
Mass	ounce	1 g	0.03527 oz.	1 oz.	28,350 g
	pound	1 kg	2.205 lb.	1 lb.	0,45359 kg
	short ton	1 tonne	1.1023 short ton	1 short ton	0,90719 tonne
	long ton	1 tonne	0.9842 long ton	1 long ton	1,0161 tonne
Density	pound per cubic inch	1 g/cm ³	0.0361 lb/cu-in	1 lb/cu-in	27,680 g/cm ³
Force	pound-force	1 N	0.225 lbf.	1 lbf.	4,4482 N
Pressure, stress	pounds per square inch	1 MPa	145 psi	1 psi	6,8948 × 10 ³ Pa
		1 N/mm ²	145 psi	1 psi	0,068948 bar
		1 bar	14.5 psi		
Moment	pound-force inch	1 Nm	8.85 lbf-in	1 lbf-in	0,113 Nm
Power	foot-pound per second	1 W	0.7376 ft-lbf/s	1 ft-lbf/s	1,3558 W
	horsepower	1 kW	1.36 hp	1 hp	0,736 kW
Temperature	degree	Celsius	$t_C = 0.555 (t_F - 32)$	Fahrenheit	$t_F = 1,8 t_C + 32$

Foreword

This catalogue contains the standard assortment of SKF super-precision bearings typically used in machine tool applications. To provide the highest levels of quality and customer service, these products are available worldwide through SKF sales channels. For information about lead times and deliveries, contact your local SKF representative or SKF Authorized Distributor.

The data in this catalogue reflect SKF's state-of-the-art technology and production capabilities as of 2013. The data contained within may differ from that shown in earlier catalogues because of redesign, technological developments, or revised calculation methods. SKF reserves the right to continually improve its products with respect to materials, design and manufacturing methods, some of which are driven by technological developments.

Getting started

This catalogue is divided into nine main chapters, marked with numbered blue tabs in the right margin:

- Chapter 1 provides design and application recommendations.
- Chapters 2 to 6 describe the various bearing types. Each chapter contains descriptions of the products, and product tables listing data for selecting a bearing and designing the bearing arrangement.
- Chapter 7 contains information about precision lock nuts.
- Chapter 8 presents special gauges.
- Chapter 9 contains indexes to quickly retrieve information about a specific product or topic.

The latest developments

Compared to the previous catalogue, nearly each and every bearing has been redesigned to meet increasing application requirements. Many sizes and variants have been added to the assortment. The main content updates include:

More angular contact ball bearing sizes

Angular contact ball bearings in the 18 dimension series are included for the first time. In the other dimension series, several sizes have been added to both ends of the size range. The number of sealed bearings is about three times the number in the previous catalogue and also the number of hybrid bearings has been increased.



New super-precision angular contact ball bearings in the 18 dimension series

Foreword

More angular contact ball bearing variants

Angular contact ball bearings offer more choice:

- variants for direct oil-air lubrication
- greater variety in preload classes
- bearings with ceramic balls and rings made of NitroMax steel

New series of double direction angular contact thrust ball bearings

The previous bearing series 2344(00) has been replaced by the new BTW series. Bearings in the BTW series accommodate higher speeds with less friction, have a lower weight and are easier to mount.

Axial-radial cylindrical roller bearings

Axial-radial cylindrical roller bearings have been added to the catalogue. These bearings are commonly used to support rotary tables, indexing heads and multi-spindle heads on machining centres.

Bearings with PEEK cages

Cages made of reinforced PEEK enable bearings to accommodate higher speeds and run more quietly. Many more angular contact ball bearings and cylindrical roller bearings are available with cages made of this material.



Bearings with ceramic balls and rings made of NitroMax steel



BTW series bearings replace the former 2344(00) series



Axial-radial cylindrical roller bearings



PEEK cages enable higher speeds and quieter running

Foreword

Other SKF products and services

SKF offers a wide range of products, services and solutions, not presented in this catalogue, but perhaps needed when using SKF super-precision bearings. For information about these products, contact SKF or visit skf.com. The offer includes:

Lubrication systems

SKF provides a range of automatic lubrication technologies, each offering a number of important advantages, from improved production and reduced total cost of ownership to a healthier, more environmentally friendly workplace. SKF can supply spindle lubrication systems that are suitable for most of the speed ranges and provides customized multi-point lubrication systems for linear guides, screw drives, bearings and auxiliary equipment as well as automated minimal quantity lubrication systems for machining processes that reduce environmental impact and create healthier work environments.

Coolant pumps

SKF offers a full range of space-saving centrifugal and screw spindle pumps, each engineered to provide a reliable and efficient supply of cooling fluid in specific machine tool applications. Due to immersed installation, most of these pumps operate without seals, reducing maintenance and, ultimately, total cost of ownership. Available in numerous designs for various media, flow rates and operating pressures, these pumps can be provided with assorted standard drive options and electrical connection ratings.



Lubrication system



Coolant pumps

Linear motion technologies

By combining competencies in linear motion, bearings, sealing solutions, lubricants and lubrication systems with best practices, SKF offers solutions for linear drive and for guiding systems, including profile rail guides, precision rail guides, dovetail slides, standard linear slides and linear ball bearings. All are designed for ease of maintenance and reliability.

Linear drives for many machine tool axes are equipped with ball screws or roller screws. SKF ball and roller screws provide a fast and precise linear movement, even under high load conditions.

Roller screws fitted on machine axes provide the unique advantages of rapid acceleration, high linear speed and high load carrying capability combined with high axial stiffness. Satellite roller screws, which do not have recirculation systems and which do not exhibit friction between rolling elements, provide higher accuracy when machine tool axes reverse direction. Roller screws are also available with the support bearings pre-assembled on a screw shaft – ready to bolt in place, speeding up and simplifying assembly and alignment procedures.



Linear motion technologies



Seals

Custom sealing solutions

Decades of experience manufacturing seals, combined with advanced materials expertise, has made SKF a leading supplier of standard and custom-engineered sealing solutions. These include integrated solutions consisting of seals and advanced engineered plastic parts, as well as moulded seals for higher volume orders and high-performance machined seals for hydraulic and pneumatic applications like press-cylinders, valves or clamping devices as well as for rotary applications like rotary distributors, joints or indexing tables.

Due to flexible production processes, customers can benefit from short delivery times and just-in-time deliveries for standard and custom seals. A wide variety of high performance sealing materials – including hydrolysis-resistant and/or self-lubricated polyurethanes, fluoro-carbon-rubbers and different PTFE-compounds – provides high wear resistance, long service-life and chemical compatibility with various machine tool fluids. In addition, SKF supports customers with on-site solution analysis and application engineering support.

Foreword

Spindle condition monitoring

The monitoring of spindle health is crucial to avoiding machining process disturbances and unplanned production stops. SKF provides a complete family of condition monitoring tools and technologies, from hand-held data collectors and analyzers to online surveillance and protection systems that provide reliable insight into machine condition including bearing, imbalance and lubrication issues.

These systems improve operational efficiency and reduce costs by eliminating unplanned downtime and enabling machine tool operators to schedule maintenance based on condition rather than time schedules. The data logging system can be integrated with the machine's control system for aligned corrective actions. For example, the SKF Spindle Assessment Kit is a complete solution for reliable, simplified, onboard condition monitoring. The kit includes an SKF Microlog Advisor Pro, acceleration sensor, laser tachometer, dial gauge with stand, belt tension gauge and a software package. SKF assists in the set up of measuring points on your machine tool spindles and also offers a consulting service as part of a service agreement .



Spindle condition monitoring

Advanced calculation tools

SKF Spindle Simulator is an advanced simulation software program for the analysis of spindle applications. Based on the SKF Simulator platform and using the same advanced technology, it has been designed to be exceptionally user friendly.

The software is able to simulate the effects of user-defined speed and temperature distribution on bearing shaft and housing fits and preload. In addition, at each step of the spindle's duty cycle, it analyzes the effect of the external loads on the shaft and the bearings and delivers highly accurate information about the contact for each rolling element in each bearing.

This program supports the analysis of spindles and contains detailed and up-to-date models of SKF super-precision bearings.



SKF Spindle Simulator

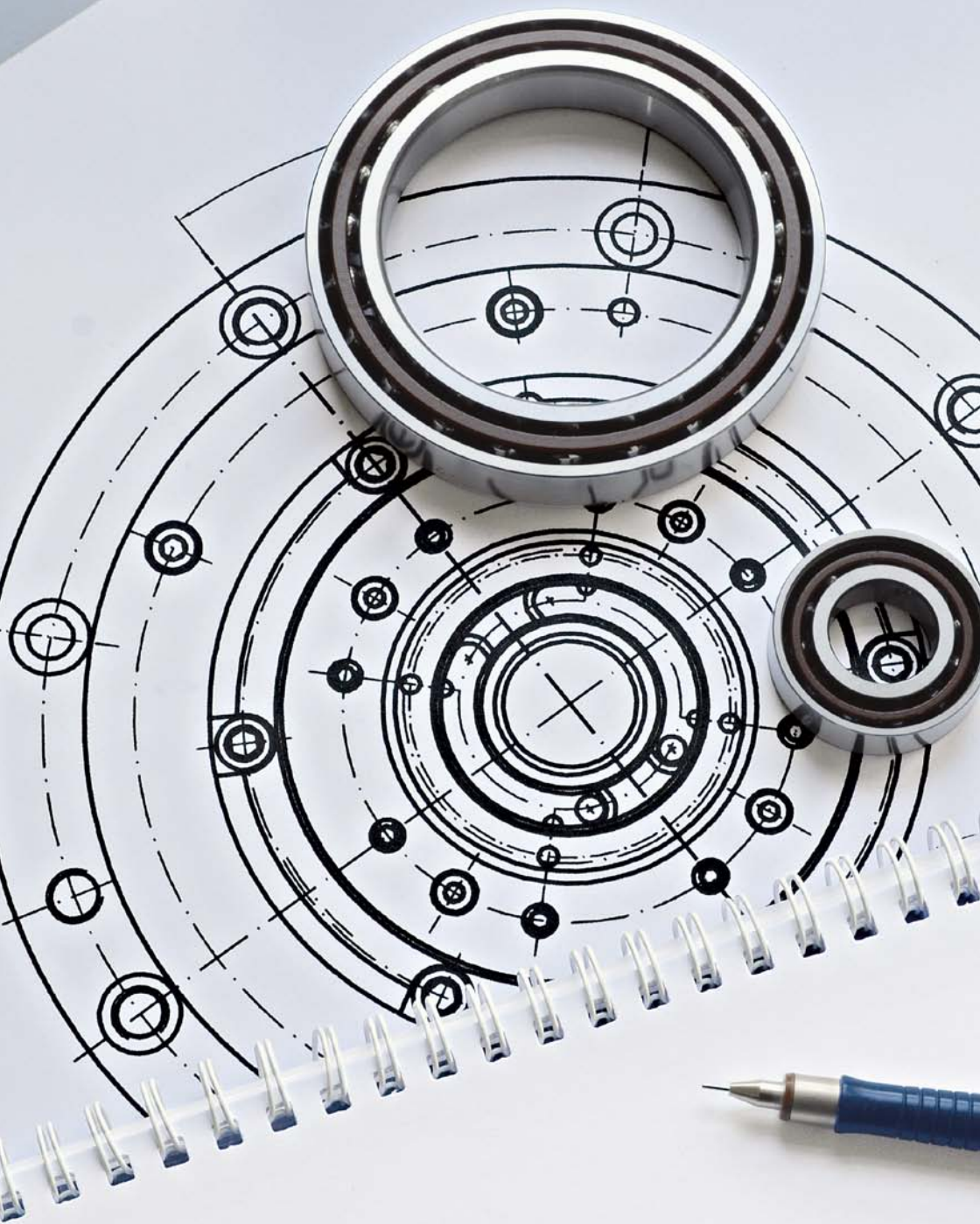

Principles of bearing selection and application

Selecting super-precision bearings . . .	20	Design considerations	57
Bearing types and designs	21	Bearing arrangements	57
Basic selection criteria	23	System rigidity	66
		Bearing stiffness	68
Bearing life and load ratings	33	Radial location of bearings	70
Dynamic bearing loads and life	33	Recommended shaft and housing fits	70
Basic dynamic load rating	33	Accuracy of seats and abutments	75
Equivalent dynamic bearing load	33	Axial location of bearings	78
Basic rating life	34	Locating methods	78
Rating life for hybrid bearings	34	Stepped sleeves	80
Requisite minimum load	34	Provisions for mounting and dismounting	88
Calculating life with variable operating conditions	35	Bearing preload	90
Permissible static loads	36	Sealing solutions	95
Basic static load rating	36	External seals	95
Equivalent static bearing load	36	Integral seals	98
Required basic static load rating	36		
Friction	37	Lubrication	99
Effects of clearance and preload on friction	37	Grease lubrication	99
Effects of grease fill on friction	37	Oil lubrication	113
Frictional behaviour of hybrid bearings	37	Lubricant storage	122
Speeds	38	Mounting and dismounting	123
Permissible speeds	39	Where to mount	123
Attainable speeds	44	Methods and tools	123
Attainable speeds for typical spindle bearing systems	44	Mounting recommendations	123
		Test running	124
		Dismounting	124
		Reusing bearings	124
		SKF spindle service	125
Bearing specifics	46	Bearing storage	125
Boundary dimensions	46		
Tolerances	47		
Preload and internal clearance	50		
Materials	51		
Materials for bearing rings and rolling elements	51		
Cage materials	55		
Seal materials	56		

Selecting super-precision bearings

A shaft system consists of more than just bearings. Associated components like the shaft and housings are integral parts of the overall system. The lubricant and sealing elements also play a crucial role. To maximize bearing performance, the correct amount of an appropriate lubricant must be present to reduce friction in the bearing and protect it from corrosion. Sealing elements are important because they keep the lubricant in and contaminants out of the bearing. This is particularly important since cleanliness has a profound effect on bearing service life. Therefore, SKF manufactures and sells a wide range of industrial seals and lubrication systems.

There are a number of factors that go into the bearing selection process:

- available space
- loads (magnitude and direction)
- precision and stiffness
- speeds
- operating temperature
- vibration levels
- contamination levels
- lubrication type and method

Once a suitable bearing has been selected, there are several other factors that need to be considered:

- suitable form and design of other components in the arrangement
- appropriate fits and bearing internal clearance or preload
- locking devices
- adequate seals
- mounting and dismounting methods

When designing an application, every decision affects the performance, reliability and economy of the shaft system.

As the leading bearing supplier, SKF manufactures a wide assortment of super-precision bearing types, series, designs, variants and sizes. The most common of them are introduced under *Bearing types and designs*.

Under *Principles of bearing selection and application*, the designer of a bearing system can find the necessary basic information, presented in the order in which it is generally required. Obviously, it is impossible to include all the information needed to cover every conceivable application. For this reason, in many places, reference is made to the SKF application engineering service. This technical service can perform complex calculations, diagnose and solve bearing performance issues, and help with the bearing selection process. SKF also recommends this service to anyone working to improve the performance of their application.

The information provided under *Principles of bearing selection and application* is general and applies to most super-precision bearings. Information specific to one bearing type is provided in the relevant product chapter.

It should be noted that many of the values listed in the product tables are rounded.

Bearing types and designs

SKF's comprehensive assortment of super-precision bearings is designed for machine tool spindles and other applications that require a high level of running accuracy at high to extremely high speeds. Each bearing type incorporates unique features to make it suitable for specific operating conditions. For details about the different bearing types, refer to the relevant product chapter.

Angular contact ball bearings (→ page 127)

high-capacity (D design) (1)

high-speed (E design) (2)

high-speed (B design) (3)

all designs in different variants:

- for single mounting or matched bearing sets
- for universal matching or universally matchable sets
- bearings with steel balls or hybrid bearings
- open or with seals (3)

Cylindrical roller bearings (→ page 263)

single row (N design)

- basic design (4)
- high-speed designs (5)
- hybrid bearings

double row (NN design) (6)

- bearings with steel rollers
- hybrid bearings

double row (NNU design) (7)

Double direction angular contact thrust ball bearings (→ page 301)

basic design (BTW series) (8)

- bearings with steel balls
- hybrid bearings

high-speed design (BTM series) (9)

- bearings with steel balls
- hybrid bearings

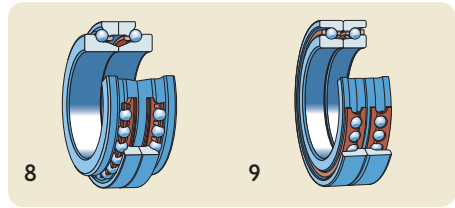
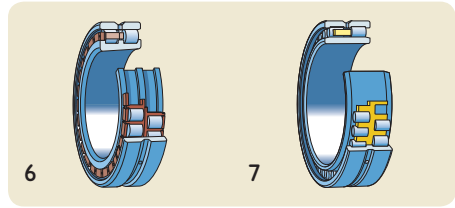
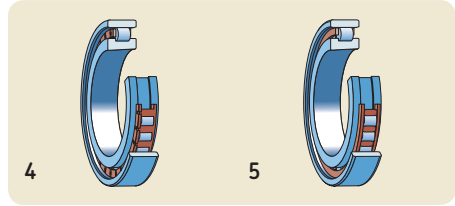
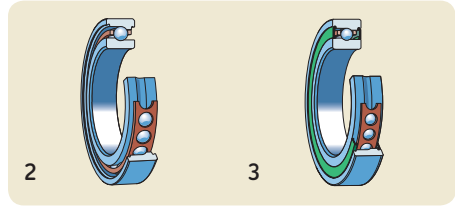
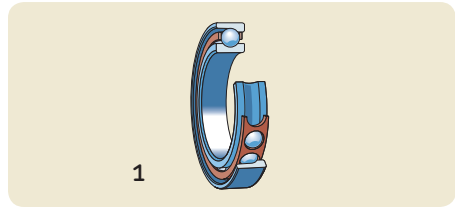

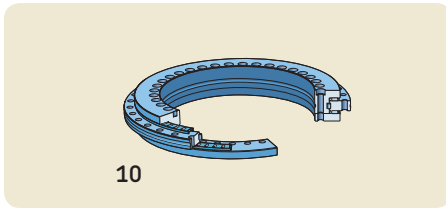

Axial-radial cylindrical roller bearings
(→ page 319)
basic design (NRT series) (10)

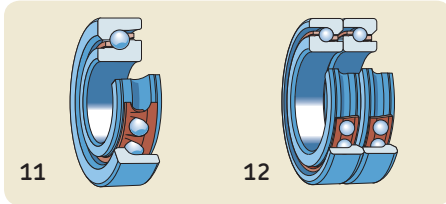

Angular contact thrust ball bearings for screw drives (→ page 337)
single direction (BSA and BSD series) (11),
universally matchable for mounting as sets (12)
– bearings with seals (13)
double direction with seals (BEAS series) (14)
– for bolt mounting (BEAM series) (15)
cartridge units with a flanged housing (FBSA series) (16)

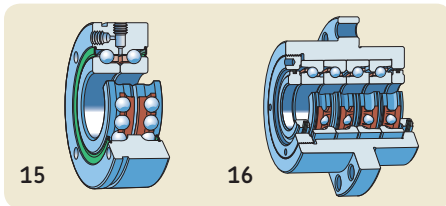
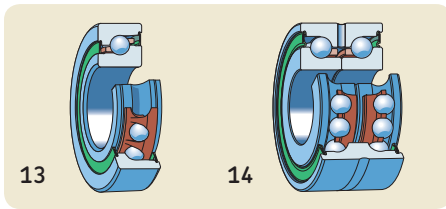

Cages

The super-precision bearings shown in this catalogue all contain a cage. For some special applications, however, bearings without a cage (full complement) may be offered. The primary purposes of a cage are to:

- Separate the rolling elements to reduce the frictional moment and frictional heat in the bearing.
- Keep the rolling elements evenly spaced to optimize load distribution and enable quiet and uniform operation.
- Guide the rolling elements in the unloaded zone, to improve the rolling conditions and to help avoid damaging sliding movements.
- Retain the rolling elements of separable bearings when one bearing ring is removed during mounting or dismounting.

Cages are mechanically stressed by frictional, strain and inertial forces. They can also be degraded by high temperatures and chemicals like certain lubricants, lubricant additives or by-products of their ageing, organic solvents or coolants. Therefore, both the design and material of a cage have a significant influence on the suitability of a rolling bearing for a particular application. As a result, SKF has developed a variety of cages, made of different materials, for different bearing types and operating conditions.

In each product chapter, information about standard cages and possible alternatives is provided. Standard cages are those considered most suitable for the majority of applications. If a bearing with a non-standard cage is required, check availability prior to ordering.

Basic selection criteria

Bearing selection is paramount when dealing with machine tool spindles and other applications that require a high degree of running accuracy at high speeds. The SKF super-precision bearing assortment comprises different bearing types, each with features designed to meet specific application requirements.

Since several factors have to be considered and weighed when selecting a super-precision bearing, no general rules can be given. The following factors are the most important to be considered when selecting a super-precision bearing:

- precision (→ page 20)
- rigidity (→ page 26)
- available space (→ page 27)
- speeds (→ page 28)
- loads (→ page 30)
- axial displacement (→ page 31)
- sealing solutions (→ page 32)

The total cost of a shaft system and inventory considerations can also influence bearing selection.

Some of the most important criteria to consider when designing a bearing arrangement are covered in depth in separate sections of this catalogue. Detailed information on the individual bearing types, including their characteristics and the available designs, is provided in each product chapter.

Where demands on precision and productivity are exceptionally high, it may be necessary to contact the SKF application engineering service. For highly demanding applications, SKF offers special solutions such as:

- hybrid bearings (→ page 54)
- bearings made of NitroMax steel (→ page 52)
- coated bearings

Precision

When dealing with rolling bearings, precision is described by tolerance classes for running accuracy and dimensional accuracy. **Table 1** shows a comparison of the tolerance classes used by SKF and different standards organisations.

Most SKF super-precision bearings are manufactured to P4A, P4C or SP tolerance classes. Standard and optional tolerance

classes for SKF super-precision bearings are listed in **table 2**.

Each product chapter provides information about the tolerance classes to which the bearings are manufactured.

Table 1

Comparison of the tolerance classes

SKF tolerance class	Standard tolerance classes in accordance with different standards					
	Running accuracy ISO ¹⁾	ANSI/ABMA ²⁾	DIN ³⁾	Dimensional accuracy ISO ¹⁾	ANSI/ABMA ²⁾	DIN ³⁾
P4A	2 ⁴⁾	ABEC 9 ⁴⁾	P2 ⁴⁾	4	ABEC 7	P4
P4	4	ABEC 7	P4	4	ABEC 7	P4
P5	5	ABEC 5	P5	5	ABEC 5	P5
P2	2	ABEC 9	P2	2	ABEC 9	P2
PA9A	2	ABEC 9	P2	2	ABEC 9	P2
P4C	4	ABEC 7	P4	4	ABEC 7	P4
SP	4	ABEC 7	P4	5	ABEC 5	P5
UP⁵⁾	2	ABEC 9	P2	4	ABEC 7	P4

1) ISO 492 or ISO 199

2) ANSI/ABMA Std. 20

3) DIN 620-2 or DIN 620-3

4) d > 120 mm → ISO 4 or better, ABEC 7 or better, DIN P4 or better

5) Depending on bearing size, accuracy might be even better.

Table 2

Standard and optional tolerance classes for SKF super-precision bearings

Bearing type	Standard tolerance class	Optional tolerance class
Angular contact ball bearings	P4A or P4 ¹⁾	PA9A or P2 ¹⁾
Cylindrical roller bearings	SP	UP
Double direction angular contact thrust ball bearings in the BTW series	SP	UP
Double direction angular contact thrust ball bearings in the BTM series	P4C	–
Angular contact thrust ball bearings for screw drives	P4A	–
Axial-radial cylindrical roller bearings ²⁾	–	–

1) Only for 718 D series

2) Radial run-out equal to or better than P4, axial run-out close to P4. Reduced axial and radial run-out on request.

Running accuracy

The running accuracy of a shaft system depends on the accuracy of all the components within the system. Running accuracy of a bearing is mainly affected by the accuracy of the form and position of the raceways on the bearing rings.

When selecting the appropriate tolerance class for a particular bearing, the maximum radial or axial run-out (depending on the bearing type) of the inner ring is usually the determining factor for most applications.

Diagram 1 compares relative values of the maximum radial run-out of the inner ring for different tolerance classes.

Dimensional accuracy

The accuracy of the boundary dimensions of both a bearing and its mating components is very important to achieve the appropriate fit. The fits between the bearing inner ring and shaft or outer ring and housing influence the internal clearance or preload of the mounted bearing.

Cylindrical roller bearings with a tapered bore have slightly larger permissible dimensional deviations than other types of super-precision bearings. That is because the clearance or preload is determined during mounting, by driving the inner ring up on its tapered seat.

Diagram 1

Relative radial run-out limits for different tolerance classes

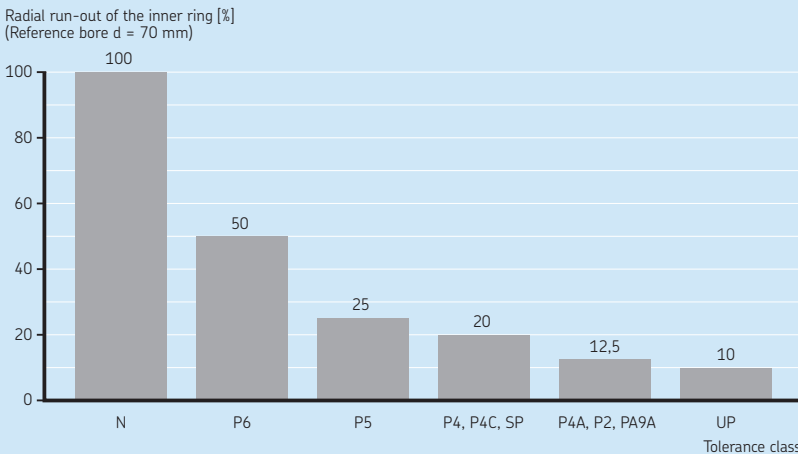

Rigidity

In machine tool applications, the rigidity of the spindle is extremely important as the magnitude of elastic deformation under load heavily influences the productivity and accuracy of the tool. Although bearing stiffness contributes to system rigidity, there are other influencing factors including tool overhang as well as the number and position of the bearings.

Factors that determine bearing stiffness include:

- **The rolling element type**
Roller bearings are stiffer than ball bearings. Ceramic rolling elements are stiffer than those made of steel.
- **The number and size of the rolling elements**
A larger number of smaller diameter rolling elements increases the degree of stiffness.
- **The contact angle**
A contact angle close to the load angle results in a higher degree of stiffness.
- **The internal design**
A close osculation results in a higher degree of stiffness for angular contact ball bearings.

In applications requiring a high degree of radial rigidity, cylindrical roller bearings are typically the best option. However, angular contact ball bearings with a minimal contact angle can also be used.

In applications where a high degree of axial rigidity is required, angular contact thrust ball bearings with a large contact angle are preferred. Rigidity can be increased by preload, but this can limit the permissible speed.

For additional information about system rigidity and bearing stiffness, refer to *System rigidity* (→ page 66).

Available space

High-precision applications generally call for bearings with a low cross-sectional height due to limited space and high requirements for rigidity and running accuracy. Bearings with a low cross-sectional height are able to accommodate relatively large-diameter shafts to provide the necessary rigidity within a relatively small bearing envelope.

Angular contact ball bearings, cylindrical roller bearings and angular contact thrust ball bearings commonly used in machine tool applications are almost exclusively bearings in the ISO 9 and 0 diameter series (→ **fig. 1**).

Angular contact ball bearings in the 2 diameter series are rarely used in new designs, but are still common in existing applications. When a compact cross section is a key requirement, angular contact ball bearings in the 8 diameter series are the preferred solution.

By selecting bearings in the 9 or 0 diameter series, it is possible to achieve an optimal bearing arrangement regarding rigidity and load carrying capacity for a particular application within the same radial space.

Angular contact thrust ball bearings for screw drives have larger cross-sectional heights. Diameter series 2 and 3 are common for these bearings. The available space is typically not a major concern, but load carrying capacity is extremely important.

Fig. 1

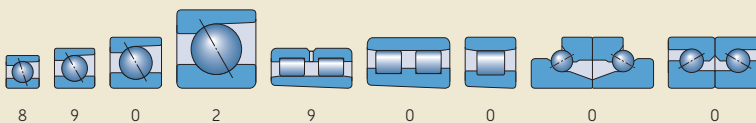

Speeds

The attainable speeds for super-precision bearings are primarily dependent on bearing type, design and material, type and magnitude of load as well as lubricant and lubrication method. For the permissible speed, operating temperature is an additional limit.

Super-precision bearing arrangements in high-speed applications require bearings that generate the least amount of friction and frictional heat. Super-precision angular contact ball bearings and cylindrical roller bearings are best suited for these applications. For extremely high speeds, hybrid bearings (bearings with ceramic rolling elements) may be necessary.

When compared to other super-precision bearing types, angular contact ball bearings enable the highest speeds. **Diagram 2** compares the relative speed capability of SKF angular contact ball bearings in the different series. For details about the bearing series, refer to *Designation system* on **page 196**.

Thrust bearings cannot accommodate speeds as high as radial bearings.

It is a general rule that a certain loss of rigidity must be tolerated to attain higher speeds.

For additional information about attainable speeds, refer to *Speeds* (→ **page 38**).

Relative speed capability of angular contact ball bearings

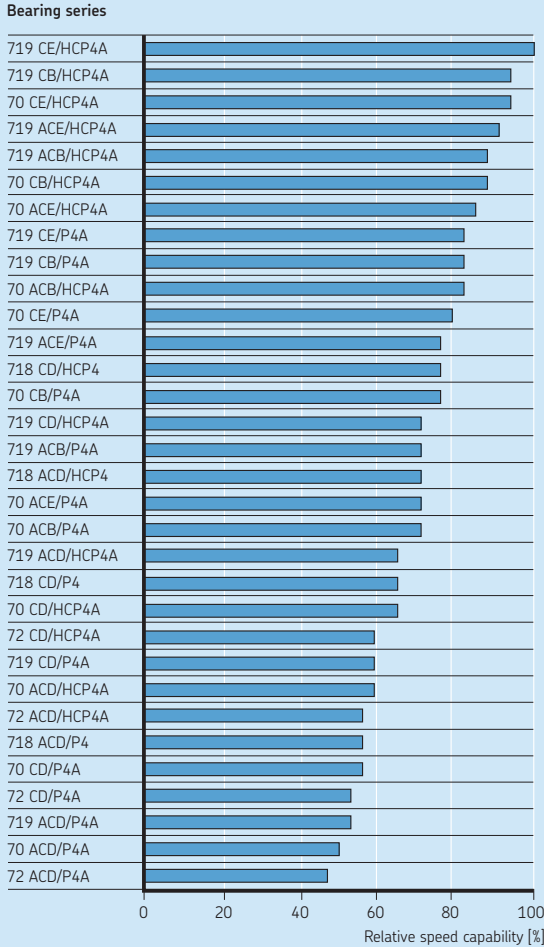

- AC 25° contact angle
- C 15° contact angle
- B High-speed B design
- E High-speed E design
- D High-capacity D design
- HC Ceramic balls

Loads

When selecting SKF super-precision bearings for high-speed applications, calculated rating life (and therefore basic load rating) is typically not a limiting factor. Other criteria such as stiffness, size of the required bore in a hollow shaft, machining speed and accuracy are normally the decisive factors.

When selecting the bearing type, the magnitude and direction of the load play an important role.

Radial loads

Super-precision cylindrical roller bearings can accommodate heavier radial loads than same-size ball bearings. They are incapable of supporting axial loads but can accommodate a limited amount of axial displacement between their inner and outer rings because there are no flanges on either the inner or outer ring, depending on the specific design.

Axial loads

Double direction angular contact thrust ball bearings in the BTW and BTM series are designed to support axial loads only, acting in either direction. Sets of angular contact ball bearings are also a viable solution, particularly in high-speed applications.

For large size bearing arrangements or those subjected to very heavy axial loads, special single direction thrust ball bearings or cylindrical roller thrust bearings are recommended. For detailed information about these special bearings, contact the SKF application engineering service.

To be sure that an axial bearing is only subjected to axial loads, the housing washer should be mounted with radial clearance.

Combined loads

A combined load consists of a radial and axial load acting simultaneously (\rightarrow fig. 2). A very effective way to accommodate combined loads is by using bearing types that can accommodate both radial and axial loads.

Super-precision bearings with these characteristics include:

- angular contact ball bearings in the 718, 719, 70 and 72 series
- single direction angular contact thrust ball bearings for screw drives in the BSA and BSD series
- double direction angular contact thrust ball bearings for screw drives in the BEAS and BEAM series
- axial-radial cylindrical roller bearings in the NRT series

The ability of a bearing to accommodate an axial or radial load is determined by the contact angle α (\rightarrow fig. 2). A bearing with a 0° contact angle can accommodate pure radial loads only. As the contact angle increases, the axial load carrying capacity increases proportionately. When the contact angle reaches 90° , the bearing becomes a full thrust bearing, capable of accommodating only axial loads. Speed capability, however, is inversely proportional to the contact angle, meaning that as the contact angle increases, speed capability decreases.

Axial-radial cylindrical roller bearings accommodate the axial and radial components of a combined load with separate rows of rollers perpendicular to each other.

In applications where there are combined loads with a very heavy axial load component, the radial and axial loads can be supported by separate bearings.

Fig. 2



Axial displacement

In most applications where thermal expansion and contraction of the shaft must be accommodated without inducing an axial load on the bearings, a locating/non-locating bearing system is typically used.

The bearing in the locating position must be able to locate the shaft axially in both directions. In machine tool applications, a set of angular contact ball bearings or a pair of angular contact thrust ball bearings can be used.

Non-locating bearings must accommodate thermal expansion and contraction of the shaft. Cylindrical roller bearings are well suited for this because they accommodate shaft movements relative to the housing, within the bearing (→ **fig. 3**). This enables the bearing to be mounted with an interference fit on both the inner and outer rings.

If paired angular contact ball bearings are used in the non-locating position, either the inner or outer ring of both bearings must have a loose fit so that they can slide on the shaft or in the housing. A loose fit, however, has a negative effect on system rigidity.

Fig. 3

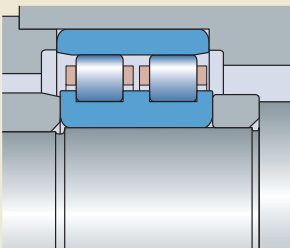

Sealing solutions

To keep lubricant in and contaminants out of the bearing, SKF can supply some super-precision bearings with integral seals:

- non-contact seals (→ **fig. 4**)
- contact seals (→ **fig. 5**)

Sealed bearings can provide cost-effective and space-saving solutions for many applications. Sealed bearings include:

- angular contact ball bearings with non-contact seals
- single direction angular contact thrust ball bearings for screw drives with non-contact seals
- double direction angular contact thrust ball bearings for screw drives with contact or non-contact seals

Bearings sealed on both sides are typically lubricated for the life of the bearing and should not be washed. They are filled with the appropriate amount of high-quality grease under clean conditions. They cannot be relubricated except for certain bearings for screw drives which are equipped with relubrication features.

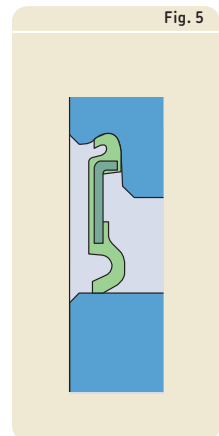
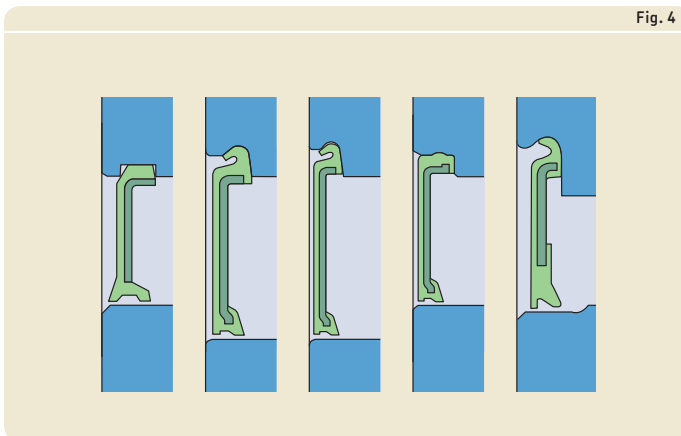

Bearing life and load ratings

In industrial applications, bearing size is usually determined by its load carrying capacity relative to the load, required life and required reliability of the application. For machine tool applications, bearing size is almost always determined by other factors such as system rigidity, fixed dimensions of the spindle as well as the speed and feed parameters of the application.

For super-precision bearing arrangements, determining the actual load is particularly complex as it involves many influencing factors. *SKF Spindle Simulator* is a sophisticated computer program to analyse statically indeterminate spindle bearing systems. It supports the analysis of spindles and contains detailed models of super-precision bearings. For additional information, contact the SKF application engineering service or visit *SKF Engineering Consultancy Services* at skf.com.

Dynamic bearing loads and life

The general information about bearing life calculation and basic load ratings provided under *Selecting bearing size* in the SKF catalogue *Rolling bearings*, or at skf.com, is also valid for super-precision bearings. It should be noted that all life calculations based on ISO 281 are valid for normal speeds. For applications where the speed factor $A \geq 500\,000$ mm/min, contact the SKF application engineering service.

$$A = n d_m$$

where

A = speed factor [mm/min]

d_m = bearing mean diameter [mm]
= $0,5 (d + D)$

n = rotational speed [r/min]

Rated bearing life can be calculated for fatigue conditions based on statistical assumptions. For detailed information, refer to *Basic rating life* in the SKF catalogue *Rolling bearings*, or visit skf.com.

Basic dynamic load rating

The basic dynamic load rating C is used for life calculations involving dynamically stressed bearings, i.e. bearings that rotate under load. It expresses the bearing load that will result in an ISO 281 basic rating life L_{10} of 1 000 000 revolutions. It is assumed that the load is constant in magnitude and direction and is radial for radial bearings and axial, acting centrally, for thrust bearings.

Values for the basic dynamic load rating C are listed in the product tables.

Equivalent dynamic bearing load

To calculate the basic rating life for a bearing using basic dynamic load ratings, it is necessary to convert the actual dynamic loads into an equivalent dynamic bearing load. The equivalent dynamic bearing load P is defined as a hypothetical load, constant in magnitude and direction, that acts radially on radial bearings and axially and centrally on thrust bearings. This hypothetical load, when applied, would have the same influence on bearing life as the actual loads to which the bearing is subjected.

Information and data required for calculating the equivalent dynamic bearing load is provided in each product chapter.

Basic rating life

The basic rating life of a bearing in accordance with ISO 281 is

$$L_{10} = \left(\frac{C}{P} \right)^p$$

If the speed is constant, it is often preferable to calculate the life expressed in operating hours using

$$L_{10h} = \frac{10^6}{60 n} L_{10}$$

where

L_{10} = basic rating life (at 90% reliability)
[million revolutions]

L_{10h} = basic rating life (at 90% reliability)
[operating hours]

C = basic dynamic load rating [kN]

P = equivalent dynamic bearing load [kN]

n = rotational speed [r/min]

p = exponent of the life equation
= 3 for ball bearings
= 10/3 for roller bearings

Rating life for hybrid bearings

When calculating the rating life for hybrid bearings, the same life values can be used as for bearings with steel rolling elements. The ceramic rolling elements in hybrid bearings are much harder and stiffer than steel rolling elements. Although this increased level of hardness and stiffness creates a higher degree of contact stress between the ceramic rolling elements and the steel raceway, field experience and laboratory tests show that the same rating lives can be used for both bearing types.

Extensive experience and testing show that in typical machine tool applications, the service life of a hybrid bearing is significantly longer than the service life of a bearing with steel rolling elements. The extended service life of hybrid bearings is due to the hardness, low density and surface finish of the rolling elements. Low density minimizes internal loading from centrifugal and inertial forces while increased hardness makes the rolling elements less susceptible to wear. Their surface finish enables the bearing to optimize the effects of the lubricant.

Requisite minimum load

In bearings that operate at high speeds or are subjected to rapid accelerations or rapid changes in the direction of load, the inertial forces of the rolling elements and the friction in the lubricant can have a detrimental effect on the rolling conditions in the bearing arrangement and may cause damaging sliding movements to occur between the rolling elements and raceways. To provide satisfactory operation, rolling bearings must always be subjected to a given minimum load. A general "rule of thumb" indicates that minimum loads of 0,01 C should be imposed on ball bearings and 0,02 C on roller bearings.

Calculating life with variable operating conditions

In some applications, the operating conditions, such as the magnitude and direction of loads, speeds, temperatures and lubrication conditions are continually changing. In these types of applications, bearing life cannot be calculated without first reducing the load spectrum or duty cycle of the application to a limited number of simplified load cases.

In case of continuously changing loads, each different load level can be accumulated and the load spectrum reduced to a histogram of constant load blocks (→ **diagram 3**). Each block should characterize a given percentage or time-fraction during operation. Note that heavy and normal loads consume bearing life at a faster rate than light loads. Therefore, it is important to have shock and peak loads well represented in the load diagram, even if the occurrence of these loads is relatively rare and limited to a few revolutions.

Within each duty interval, the bearing load and operating conditions can be averaged to some constant value. The number of operating hours or revolutions expected from each duty interval showing the life fraction required by that particular load condition should also be included. Therefore, if N_1 equals the number of revolutions required under the load condition P_1 , and N is the expected number of revolutions for the completion of all variable loading cycles, then the cycle fraction $U_1 = N_1/N$ is used by the load condition P_1 , which has a cal-

culated life of L_{101} . Under variable operating conditions, bearing life can be rated using

$$L_{10} = \frac{1}{\frac{U_1}{L_{101}} + \frac{U_2}{L_{102}} + \frac{U_3}{L_{103}} + \dots}$$

where

L_{10} = basic rating life (at 90% reliability) [million revolutions]

L_{101}, L_{102}, \dots = basic rating lives (at 90% reliability) under constant conditions 1, 2, ... [million revolutions]

U_1, U_2, \dots = life cycle fraction under the conditions 1, 2, ...

Note: $U_1 + U_2 + \dots + U_n = 1$

The use of this calculation method depends very much on the availability of representative load diagrams for the application. Note that this type of load history can also be derived from a similar type of application.

Diagram 3

Histogram of constant load blocks

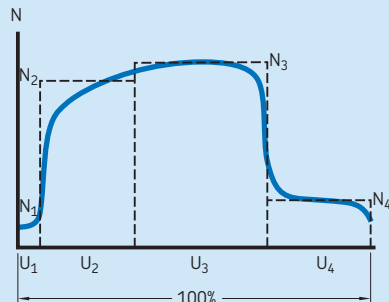
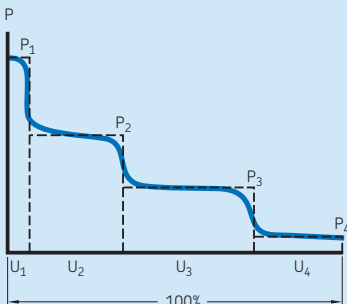

Permissible static loads

Very heavy loads or shock loads can permanently deform the raceways or rolling elements. In the case of super-precision bearing arrangements, permanent deformation must not occur. To make sure that static loads do not lead to permanent deformation, the basic static load rating of the bearing and equivalent static bearing load can be compared to determine if a bearing is at risk of permanent deformation. For very heavily loaded super-precision angular contact ball bearings, the contact ellipse truncation should be checked to avoid edge stress, which also could lead to permanent deformation. For additional information, contact the SKF application engineering service.

Basic static load rating

The basic static load rating C_0 as defined in ISO 76 corresponds to a calculated contact stress at the centre of the most heavily loaded rolling element / raceway contact. This stress produces a total permanent deformation of the rolling element and raceway, which is approximately 0,0001 of the rolling element diameter. The loads are purely radial for radial bearings and axial, centrally acting, for thrust bearings.

Values for basic static load rating C_0 are listed in the product tables.

Equivalent static bearing load

To compare actual loads with the basic static load rating, the actual loads must be converted into an equivalent load. The equivalent static bearing load P_0 is defined as that hypothetical load (radial for radial bearings and axial for thrust bearings) which, if applied, would cause the same maximum rolling element load in the bearing as the actual loads to which the bearing is subjected.

Information and data required for calculating the equivalent static bearing load are provided in each product chapter.

Required basic static load rating

The required basic static load rating C_0 , to protect the bearing from permanent deformation, can be determined from

$$C_0 \geq s_0 P_0$$

where

C_0 = basic static load rating [kN]

P_0 = equivalent static bearing load [kN]

s_0 = static safety factor

Guidelines for minimum values:

- 2 for super-precision angular contact ball bearings with steel balls (including thrust ball bearings)
- 3 for super-precision cylindrical roller bearings with steel rollers
- 4 for super precision axial-radial cylindrical roller bearings

For hybrid bearings, the static safety factor should be increased by 10%.

For angular contact thrust ball bearings for screw drives, safety factors down to $s_0 = 1$ can be used.

Friction

Friction in a bearing can be described as the total resistance to rotation. Contributing factors include, but are not limited to:

- elastic deformation of the rolling elements and raceways under load
- speeds
- lubricant and lubrication method
- sliding friction between the rolling elements and cage, flanges and guide rings, and between the seals and their counterfaces

Each of these contributes to the frictional heat generated by the bearing. The bearing operating temperature is attained when frictional heat and heat dissipated by the application are in balance.

For detailed information about friction in super-precision bearings, contact the SKF application engineering service.

Effects of clearance and preload on friction

High operating temperatures or high speeds can reduce the internal clearance or increase the preload in a bearing. Either of these changes can increase friction. This is particularly important for super-precision bearing arrangements because they are typically preloaded and are extremely sensitive to changes in preload.

For applications that are sensitive to changes in clearance or preload, contact the SKF engineering application service.

Effects of grease fill on friction

During initial start-up, or after relubrication, the frictional moment of a grease lubricated bearing can be exceptionally high during the first few hours or days of operation. This high initial frictional moment, which can be seen as a temperature spike, is caused by the uneven distribution of grease within the bearing free space.

After a running-in period, the frictional moment and bearing operating temperature are typically similar to the values for oil lubricated bearings. Bearings filled with an excessive amount of grease may have higher frictional values.

Frictional behaviour of hybrid bearings

The lower density of silicon nitride rolling elements, compared with steel, reduces internal centrifugal forces. This, combined with their low coefficient of friction, significantly reduces bearing temperatures at high speeds. Cooler running extends the service life of both the bearing and the lubricant.

Speeds

The maximum speed at which a rolling bearing can operate is largely determined by its permissible operating temperature. The operating temperature of a bearing depends on the frictional heat generated by the bearing, any externally applied heat, and the amount of heat that can be transferred away from the bearing.

Super-precision bearings that generate low levels of friction are, therefore, best suited for high-speed applications due to their corresponding low operating temperatures. When compared to similarly-sized roller bearings, ball bearings have a lower load carrying capacity but their smaller rolling contact area enables them to operate at much higher speeds. However, hybrid bearings provide additional benefits for all bearing types. **Diagram 4** compares the temperature rise in grease lubricated spindles for different bearing types. The curves for the bearings can be considered representative for the whole bearing series.

Guideline values for attainable speeds per bearing series, are provided in **diagram 5** (→ **page 40**) for oil-air lubrication and in **diagram 6** (→ **page 42**) for grease lubrication. Both diagrams are based on the speed factor A. For details about the bearing series, refer to the designation system of:

- angular contact ball bearings (→ **page 196**)
- cylindrical roller bearings (→ **page 286**)
- double direction angular contact thrust ball bearings (→ **page 311**)
- angular contact thrust ball bearings for screw drives (→ **page 364**)

Generally, bearings with a lower cross-sectional height can attain higher speeds because of the smaller value for mean diameter d_m .

Diagram 4

Temperature rise in grease lubricated spindle bearings

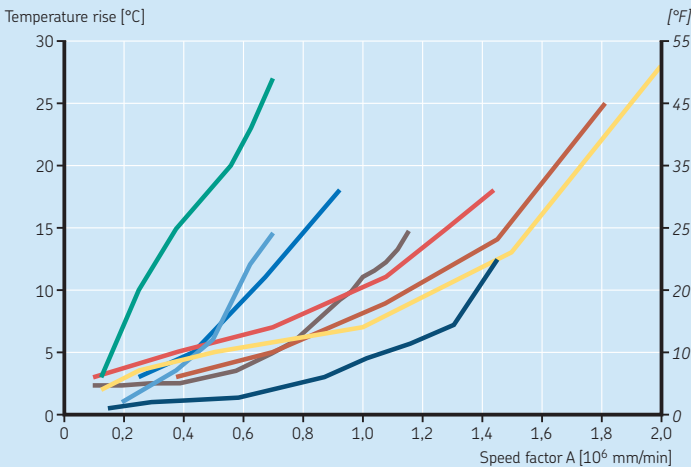

Angular contact ball bearing
 7008 CE/HC (high-speed, hybrid, spring preloaded)

Angular contact ball bearings, back-to-back
 571912 ACB/HCDBA (sealed, high-speed, hybrid)
 7205 CD/DBA (high-capacity)
 71912 CD/DBA (high-capacity, long spacers)
 7005 CD/HCDBA (high-capacity, hybrid)

Cylindrical roller bearing
 NN 3014 KTN

Angular contact thrust ball bearings
 BTW 100
 BTM 100 B

Permissible speeds

The permissible speed of a bearing depends on the frictional heat generated by the bearing, any externally applied heat and the amount of heat that can be transferred away from the bearing. In applications where heat dissipation is not adequate, either because of design considerations or high ambient temperatures, additional cooling methods might be needed in order to keep bearing temperatures within a permissible range.

Cooling can be accomplished through different lubrication methods. In oil jet and circulating oil systems, for example, the oil is filtered and, if required, cooled before being returned to the bearing.

The product tables list attainable speeds, but not speed limits, because the permissible speed is influenced by factors other than the bearing.

Guideline values for attainable speeds – oil-air lubrication

Angular contact ball bearings

Bearing series

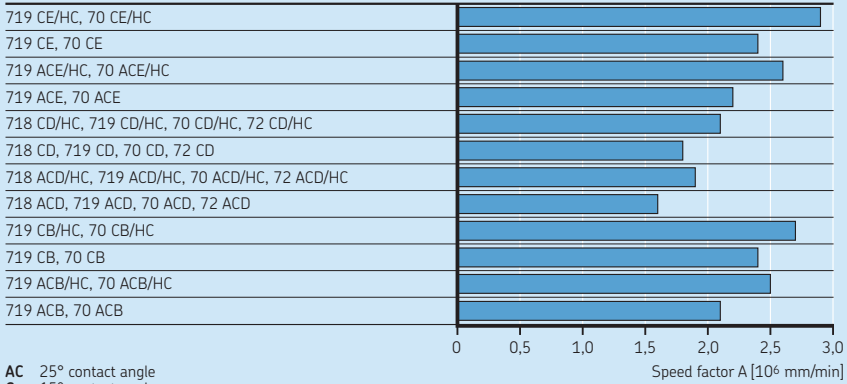

- AC 25° contact angle
- C 15° contact angle
- B High-speed B design
- E High-speed E design
- D High-capacity D design
- HC Ceramic balls

Cylindrical roller bearings

Bearing series

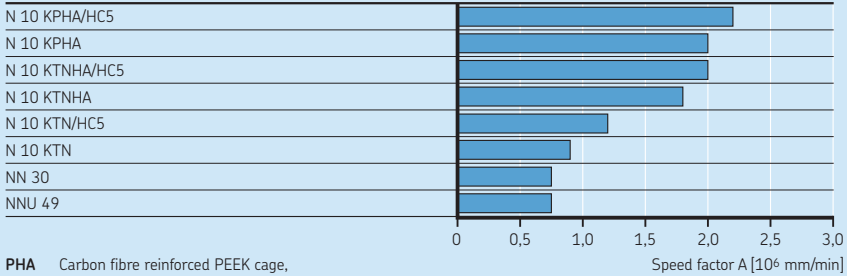

- PHA Carbon fibre reinforced PEEK cage, outer ring centred
- TN PA66 cage, roller centred
- TNHA Glass fibre reinforced PEEK cage, outer ring centred
- HC5 Ceramic rollers

Guideline values for attainable speeds – oil-air lubrication

Double direction angular contact thrust ball bearings

Bearing series

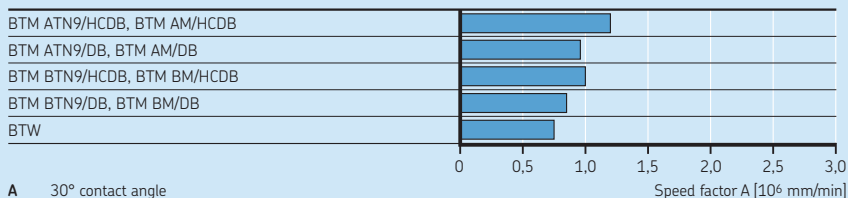
**A** 30° contact angle**B** 40° contact angle**M** Machined brass cage, ball centred**TN9** Glass fibre reinforced PA66 cage, ball centred**HC** Ceramic balls**DB** Back-to-back arrangementSpeed factor A [10^6 mm/min]

Angular contact thrust ball bearings for screw drives

Bearing series

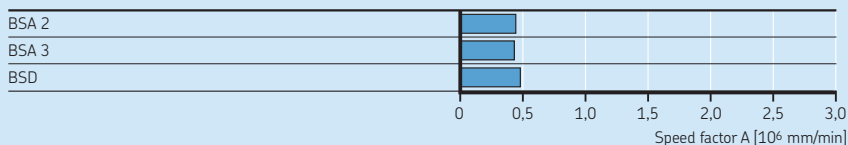
Speed factor A [10^6 mm/min]

Guideline values for attainable speeds – grease lubrication

Angular contact ball bearings

Bearing series

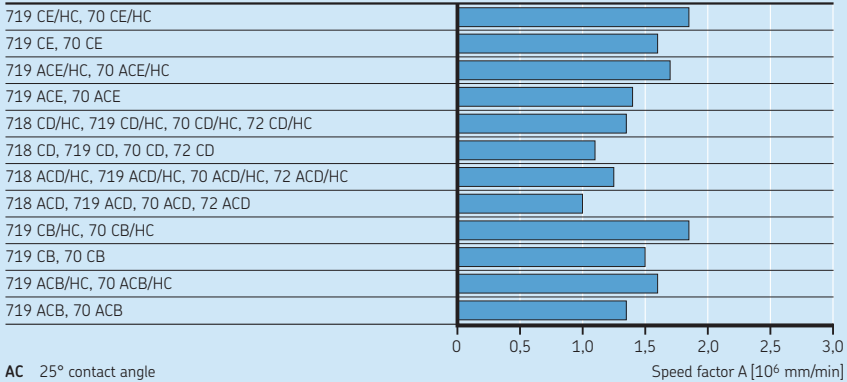

- AC 25° contact angle
- C 15° contact angle
- B High-speed B design
- E High-speed E design
- D High-capacity D design
- HC Ceramic balls

Cylindrical roller bearings

Bearing series

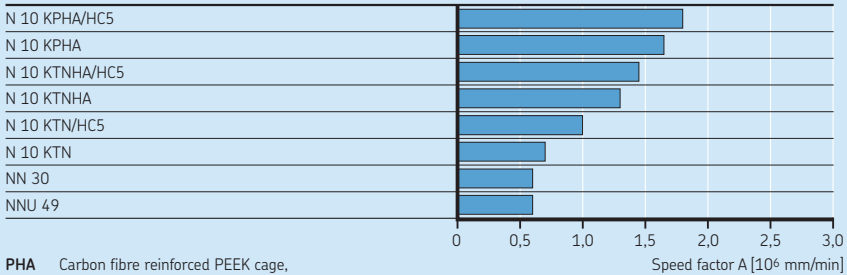

- PHA Carbon fibre reinforced PEEK cage, outer ring centred
- TN PA66 cage, roller centred
- TNHA Glass fibre reinforced PEEK cage, outer ring centred
- HC5 Ceramic rollers

Guideline values for attainable speeds – grease lubrication

Double direction angular contact thrust ball bearings

Bearing series

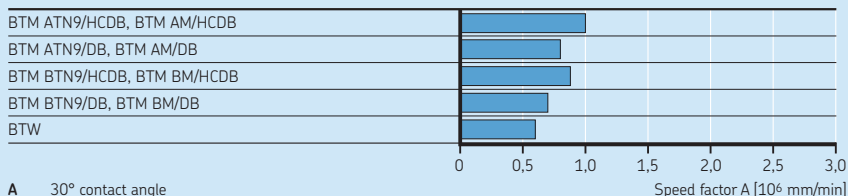
**A** 30° contact angle**B** 40° contact angle**M** Machined brass cage, ball centred**TN9** Glass fibre reinforced PA66 cage, ball centred**HC** Ceramic balls**DB** Back-to-back arrangementSpeed factor A [10⁶ mm/min]

Angular contact thrust ball bearings for screw drives

Bearing series

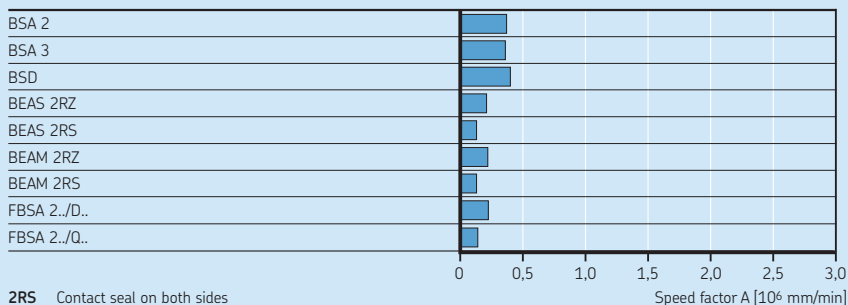
**2RS** Contact seal on both sides**2RZ** Non-contact seal on both sides**/D** Unit with two bearings**/Q** Unit with four bearingsSpeed factor A [10⁶ mm/min]

Attainable speeds

The attainable speeds listed in the product tables are guideline values and are valid under the following conditions:

- shaft seat and housing bore machined to the recommended diameter and geometric tolerances (→ *Recommended shaft and housing fits*, **page 70**)
- light loads ($P \leq 0,05 C$)
- good heat dissipation away from the bearings
- suitable lubricant and lubrication method
- light spring preload for angular contact ball bearings

The values listed in the product tables for grease lubrication can be attained using an appropriate fill of a suitable, high-quality, soft consistency grease.

The values listed in the product tables for oil-air lubrication can be adapted to apply to other oil lubrication methods. The following reduction factors should be applied:

- 0,3 to 0,4 for oil bath lubrication
- 0,95 for oil mist lubrication

Speeds in excess of the attainable speeds listed in the product tables can be achieved when an oil jet circulating oil system with an oil cooler is used.

For additional information, contact the SKF application engineering service.

Attainable speeds for typical spindle bearing systems

A typical spindle bearing system, which can contain various bearing types, comprises a bearing arrangement on the tool end and another arrangement on the non-tool end. The arrangement on the tool end is usually the critical one. It typically uses larger bearings, forcing a higher speed factor A. **Diagram 7** provides a comparison of possible bearing systems and their relative speed capability. The comparison is based on bearings with an 80 mm bore on the tool end and 70 mm bore on the non-tool end. For details about the bearing series, refer to the designation system of:

- angular contact ball bearings (→ **page 196**)
- cylindrical roller bearings (→ **page 286**)
- double direction angular contact thrust ball bearings (→ **page 311**)

Relative speed capability of typical spindle bearing systems

1

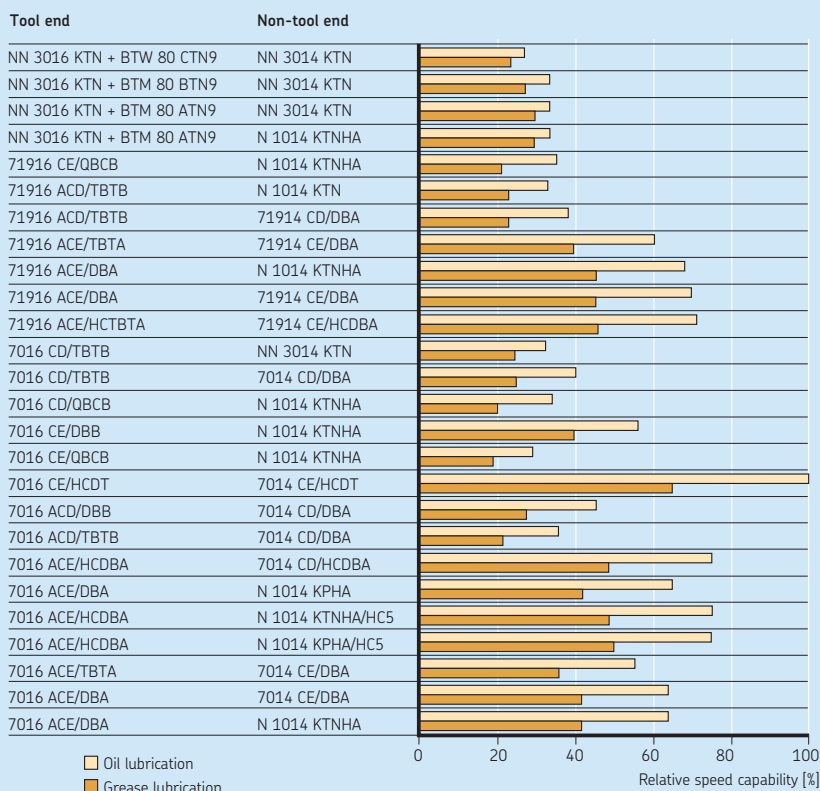
**Angular contact ball bearings**

- AC** 25° contact angle
- C** 15° contact angle
- E** High-speed E design
- D** High-capacity D design
- HC** Ceramic balls
- DB** Two bearings, back-to-back <>
- DT** Two bearings, tandem <<
- TBT** Three bearings, back-to-back and tandem <>>
- QBC** Four bearings, tandem back-to-back <<>>
- A** Light preload
- B** Moderate preload

Cylindrical roller bearings

- PHA** Carbon fibre reinforced PEEK cage, outer ring centred
- K** Tapered bore
- TN** PA66 cage, roller centred
- TNHA** Glass fibre reinforced PEEK cage, outer ring centred
- HCS** Ceramic rollers

Double direction angular contact thrust ball bearings

- A** 30° contact angle
- B** 40° contact angle
- C** 60° contact angle
- TN9** Glass fibre reinforced PA66 cage, ball centred

Bearing specifics

SKF super-precision bearings are manufactured to several general specifications. Those specifications concerning dimensions, tolerances, preload or clearance and materials are described in the following. Additional information is provided in each product chapter.

Boundary dimensions

Boundary dimensions of SKF super-precision bearings follow the ISO 15 general plan for radial rolling bearings, or, in certain circumstances, conform to boundary dimensions accepted by industry.

ISO 15 general plan

The ISO 15 general plan for boundary dimensions of radial bearings contains a progressive series of standardized outside diameters for every standard bore diameter, arranged in a diameter series. Within each diameter series, different width series have also been established.

Dimension series are formed by combining the number for the width series with the number for the diameter series.

For super-precision bearings, only a limited number of dimension series are used (→ **table 3**).

Specific information about compliance to dimension standards is provided in each product chapter.

Chamfer dimensions

Minimum values for the chamfer dimensions (→ **fig. 6**) in the radial direction (r_1, r_3) and the axial direction (r_2, r_4) are listed in the product tables. These values are in accordance with the general plans of ISO 15, ISO 12043 and ISO 12044.

The appropriate maximum chamfer dimensions are in accordance with ISO 582 and are listed under *Chamfer dimension limits*.

Table 3

Diameter and width series for SKF super-precision bearings			
ISO 15 dimension series		SKF bearing series	Bearing type
Diameter series	Width series		
8	1	718	Angular contact ball bearing
9	1	719	Angular contact ball bearing
	4	NNU 49	Double row cylindrical roller bearing
0	1	70	Angular contact ball bearing
	1	N 10	Single row cylindrical roller bearing
	3	NN 30	Double row cylindrical roller bearing
	–	BTW	Double direction angular contact thrust ball bearing
	–	BTM	Double direction angular contact thrust ball bearing
2	0	72	Angular contact ball bearing
	0	BSA 2	Angular contact thrust ball bearing for screw drives
3	0	BSA 3	Angular contact thrust ball bearing for screw drives

Tolerances

SKF super-precision bearings are manufactured to tolerance classes similar to internationally standardized tolerance classes. Standards for rolling bearing tolerances are:

- ISO 492 for radial rolling bearings
- ISO 199 for thrust rolling bearings

For available bearing types and tolerance classes, refer to *Precision* (→ page 24). Actual tolerance values are listed under *Tolerances* in each product chapter.

Tolerance symbols

The tolerance symbols and their definitions are provided in **table 4** (→ page 48).

Chamfer dimension limits

The maximum chamfer limits (→ **fig. 7**) for the relevant minimum chamfer dimensions (→ **product tables**) are listed in **table 5** (→ page 50). The values are in accordance with ISO 582.

Double direction angular contact thrust ball bearings in the BTM and BTW series and single direction angular contact thrust ball bearings for screw drives in the BSA series have the same maximum chamfer dimensions as radial bearings.

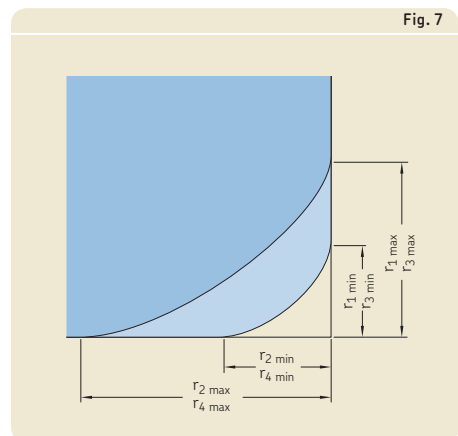
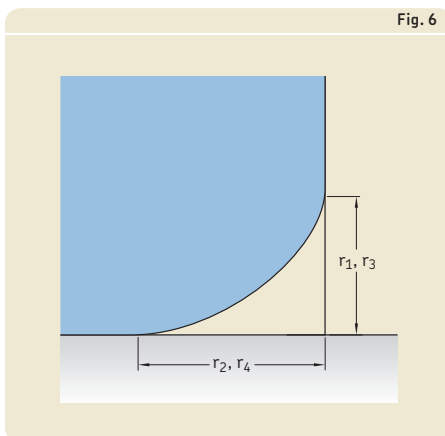

Table 4

Tolerance symbols

Tolerance symbol	Definition
Bore diameter	
d	Nominal bore diameter
d_1	Nominal diameter at the theoretical large end of a tapered bore
d_s	Single bore diameter
d_{mp}	<ol style="list-style-type: none"> 1 Mean bore diameter; arithmetical mean of the largest and smallest single bore diameters in one plane 2 Mean diameter at the small end of a tapered bore; arithmetical mean of the largest and smallest single diameters
Δ_{d_s}	Deviation of a single bore diameter from the nominal ($\Delta_{d_s} = d_s - d$)
$\Delta_{d_{mp}}$	Deviation of the mean bore diameter from the nominal ($\Delta_{d_{mp}} = d_{mp} - d$)
Δ_{d1mp}	Deviation of the mean bore diameter at the theoretical large end of a tapered bore from the nominal ($\Delta_{d1mp} = d_{1mp} - d_1$)
V_{dp}	Bore diameter variation; difference between the largest and smallest single bore diameters in one plane
V_{dmp}	Mean bore diameter variation; difference between the largest and smallest mean bore diameters
Outside diameter	
D	Nominal outside diameter
D_s	Single outside diameter
D_{mp}	Mean outside diameter; arithmetical mean of the largest and smallest single outside diameters in one plane
Δ_{D_s}	Deviation of a single outside diameter from the nominal ($\Delta_{D_s} = D_s - D$)
$\Delta_{D_{mp}}$	Deviation of the mean outside diameter from the nominal ($\Delta_{D_{mp}} = D_{mp} - D$)
V_{Dp}	Outside diameter variation; difference between the largest and smallest single outside diameters in one plane
V_{Dmp}	Mean outside diameter variation; difference between the largest and smallest mean outside diameters
Chamfer limits	
r_s	Single chamfer dimension
$r_{s \min}$	Smallest single chamfer dimension of $r_s, r_1, r_2, r_3, r_4 \dots$
r_1, r_3	Radial direction chamfer dimensions
r_2, r_4	Axial direction chamfer dimensions

Tolerance symbols

Tolerance symbol	Definition
Width or height	
B, C	Nominal width of an inner ring and outer ring, respectively
B_s, C_s	Single width of an inner ring and outer ring, respectively
B_{1s}, C_{1s}	Single width of an inner ring and outer ring, respectively, of a bearing specifically manufactured for paired mounting ¹⁾
$\Delta B_s, \Delta C_s$	Deviation of a single inner ring width or single outer ring width from the nominal ($\Delta B_s = B_s - B$; $\Delta C_s = C_s - C$)
$\Delta B_{1s}, \Delta C_{1s}$	Deviation of a single inner ring width or single outer ring width, of a bearing specifically manufactured for paired mounting ¹⁾ , from the nominal ($\Delta B_{1s} = B_{1s} - B_1$; $\Delta C_{1s} = C_{1s} - C_1$)
V_{B_s}, V_{C_s}	Ring width variation; difference between the largest and smallest single widths of an inner ring and outer ring, respectively
T	Nominal height H of a thrust bearing
$2C$	Total nominal height of outer ring of a thrust bearing
T_s	Single height
ΔT_s	Deviation of the height of a single direction thrust bearing from the nominal
ΔT_{2s}	Deviation of the height of a double direction thrust bearing from the nominal
H_s	Single bearing height
H_{1s}	Single cross section height
ΔH_s	Deviation of a single bearing height
ΔH_{1s}	Deviation of a single cross section height
Running accuracy	
K_{ia}, K_{ea}	Radial run-out of an inner ring and outer ring, respectively, of an assembled bearing
S_d	Side face run-out with reference to the bore (of an inner ring)
S_D	Outside inclination variation; variation in inclination of the outside cylindrical surface to the outer ring side face
S_{ia}, S_{ea}	Axial run-out of an inner ring and outer ring, respectively, of an assembled bearing
S_i	Thickness variation, measured from the middle of the raceway to the back (seat) face of the shaft washer (axial run-out)
S_e	Thickness variation, measured from the middle of the raceway to the back (seat) face of the housing washer (axial run-out)

¹⁾ Does not apply to universally matchable angular contact ball bearings.

Table 5

Maximum chamfer limits				
Minimum single chamfer dimension $r_{s\ min}$	Nominal bearing bore diameter		Maximum chamfer dimensions	
	d over	incl.	Radial bearings $r_{1,3\ max.}$	$r_{2,4\ max.}$
mm	mm		mm	
0,15	–	–	0,3	0,6
0,2	–	–	0,5	0,8
0,3	–	40	0,6	1
	40	–	0,8	1
0,6	–	40	1	2
	40	–	1,3	2
1	–	50	1,5	3
	50	–	1,9	3
1,1	–	120	2	3,5
	120	–	2,5	4
1,5	–	120	2,3	4
	120	–	3	5
2	–	80	3	4,5
	80	220	3,5	5
	220	–	3,5	6
2,1	–	280	4	6,5
	280	–	4,5	7
2,5	–	100	3,8	6
	100	280	4,5	6
	280	–	5	7
3	–	280	5	8
	280	–	5,5	8
4	–	–	6,5	9
5	–	–	8	10
6	–	–	10	13
7,5	–	–	12,5	17

Preload and internal clearance

Angular contact ball and thrust ball bearings

SKF super-precision universally matchable angular contact ball bearings, sets of angular contact ball bearings and angular contact thrust ball bearings are manufactured so that a predetermined amount of preload results when assembled immediately adjacent to each other. The preload values listed in the relevant product chapter represent the axial force required to press together the rings or washers of new unmounted bearings.

When mounted, and further when in operation, the preload will change. The main reasons are:

- An interference fit in the housing contracts the outer ring raceway while an interference fit on the shaft expands the inner ring raceway.
- Pressing the inner rings or shaft washers of bearings or bearing sets against each other causes deformation of the rings or washers. Especially when mounted on a solid shaft, the bore diameter cannot decrease and the lateral expansion increases preload.
- Differences in thermal expansion of the bearing rings or washers, and mating components typically increase preload in operation.

For details about the preload in unmounted bearings and ways to estimate the preload in operation, refer to the relevant product chapter.

Cylindrical roller bearings

SKF super-precision cylindrical roller bearings are manufactured with radial internal clearance. Radial internal clearance is defined as the total distance through which one bearing ring can be moved relative to the other in the radial direction.

It is necessary to distinguish between initial internal clearance in the bearing prior to mounting and operating internal clearance, which applies to a bearing in operation that has reached a stable temperature.

In almost all applications, the initial clearance in a bearing is greater than its operating clearance. The difference can be attributed to

interference fits on the shaft and/or in the housing, combined with thermal expansion of the bearing and mating components. In some cases, these factors can reduce clearance enough to create radial preload in the bearing.

For details about the internal clearance in new bearings prior to mounting and recommendations about clearance or preload in operation, refer to *Radial internal clearance* (→ page 273).

Materials

The materials from which bearing components are made, determine, to a large extent, the performance and reliability of the bearing. For the bearing rings and rolling elements, typical considerations include hardness, fatigue resistance in the rolling contact area, under clean or contaminated lubrication conditions, and the dimensional stability of the bearing components. For the cage, considerations include friction, strain, temperatures, inertial forces, and in some cases, the chemical action of certain lubricants, lubricant additives, solvents, coolants and refrigerants.

Seals integrated in rolling bearings can also have a considerable impact on the performance and reliability of the bearings. Their materials must be able to withstand oxidation (ageing), wear and chemical attack over a wide temperature range.

SKF has the competence and facilities to provide a variety of materials, processes and coatings. Therefore, SKF application engineers can assist in selecting the bearing, cage and seal materials that best meet the needs of a particular application.

Materials for bearing rings and rolling elements

Standard bearing steel

The steel used for standard SKF super-precision bearings is an extremely clean, through-hardened carbon chromium steel (100Cr6), containing approximately 1% carbon and 1,5% chromium, in accordance with ISO 683-17. The composition of this bearing steel provides an optimum balance between manufacturing and application performance. This steel normally undergoes a martensitic or bainitic heat treatment to obtain a hardness between 58 and 65 HRC.

SKF super-precision bearings are heat stabilized up to 150 °C (300 °F). But other factors like cage material, seal material or lubricant might limit the permissible operating temperature.

For information about material properties, refer to **table 6** (→ page 54).

NitroMax steel (high-nitrogen stainless steel)

NitroMax is a new generation of ultra clean, high nitrogen stainless steel. When compared to standard carbon chromium bearing steel (100Cr6), NitroMax steel provides the following:

- enhanced fatigue/wear resistance under poor lubrication conditions ($\kappa < 1$)
- higher degree of fracture toughness
- superior corrosion resistance

Each of these characteristics is beneficial when speed is higher than $A = 1$ to $1,15 \times 10^6$ mm/min.

Enhanced fatigue/wear resistance enables the bearings to operate longer under all lubrication conditions and particularly those of thin-film operation that result from kinematic lubricant starvation at very high speeds.

Increased fracture toughness reduces the risk of inner ring fracture due to increased ten-

sile hoop stresses caused by centrifugal forces when operating at very high speeds.

Compared with bearings made of carbon chromium steel, this ultra-clean, high nitrogen content steel can significantly extend bearing service life when operating under full-film lubrication conditions ($\kappa \geq 1$). Under thin-film lubrication conditions, this life extending effect is even more significant (→ **diagram 8**).

NitroMax steel is superior not only to conventional carbon chromium bearing steels but also to other high-nitrogen stainless steels. To illustrate why this is the case, it is necessary to understand the way that nitrogen influences the microstructure of the steel and how this is optimized during heat treatment.

When carbon chromium steel is heat treated, the process produces large, brittle chromium and chromium-molybdenum carbides that deplete the surrounding steel matrix of chromium and molybdenum, thereby reducing its corrosion pitting resistance. On the other hand, when NitroMax steel is hardened

Diagram 8

Relative life of hybrid bearings with NitroMax steel rings

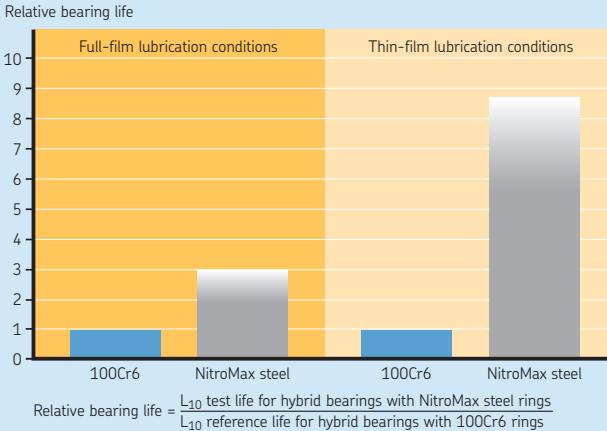

Test conditions:
 $\kappa = 2,72$ for full-film lubrication conditions
 $\kappa = 0,1$ for thin-film lubrication conditions

and tempered, small, fine chromium nitrides are formed (→ **fig. 8**). This occurs because when the nitrogen partly replaces the carbon in the steel alloy, a much higher content of chromium is dissolved in the steel matrix. The resulting, smaller chromium-depleted zones around the nitrides make NitroMax steel much more corrosion resistant (→ **fig. 9**).

The enhanced fatigue strength of NitroMax steel is associated with its coherent microstructure and fine distribution of chromium nitride precipitates with few, if any, undissolved secondary carbides in the microstructure. The fineness of the NitroMax structure compares favourably to the standard bearing steel 100Cr6, which helps in explaining the superior performance of the NitroMax steel structure. High impact toughness, dimensional stability, and hardness (> 58 HRC) result from the final quenching and tempering stages of heat treatment.

Another benefit of NitroMax steel is that it has a lower coefficient of thermal expansion than 100Cr6. This benefit, when paired with the extremely low coefficient of thermal expansion of ceramic rolling elements, used as standard in SKF bearings with NitroMax steel rings, enables bearings combining the two materials to be less sensitive to temperature differences between the inner and outer rings. The level of preload therefore remains much more stable even over the extremes of operating conditions, resulting in reduced frictional losses, lower operating temperatures and extended grease service life.

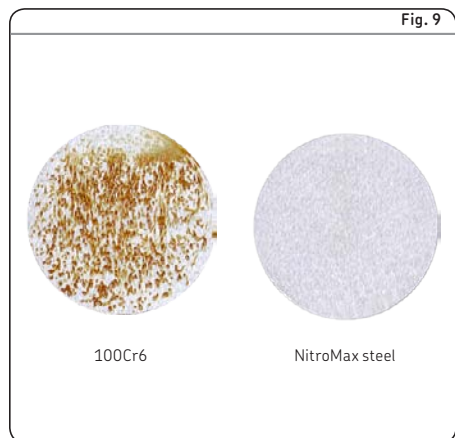
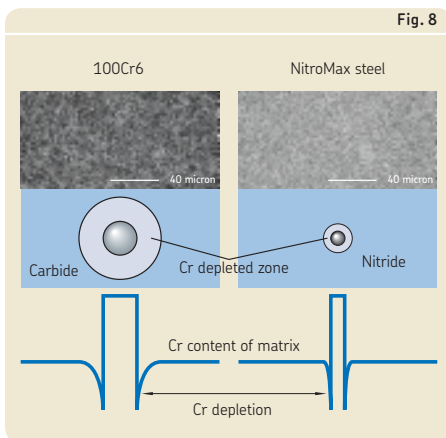

Ceramics

The ceramic material used for rolling elements in SKF super-precision bearings is a bearing grade silicon nitride in accordance with ISO 26602. It consists of fine elongated grains of beta-silicon nitride in a glassy phase matrix. It provides a combination of favourable properties especially for high-speed bearings:

- high hardness
- high modulus of elasticity
- low density
- low coefficient of thermal expansion
- high electrical resistivity
- low dielectric constant
- no response to magnetic fields

For information about material properties, refer to **table 6**.

Bearings with steel rings and ceramic rolling elements are called hybrid bearings.

Table 6

Comparison of the material properties of bearing grade silicon nitride and bearing steel 100Cr6

Material properties	Bearing grade silicon nitride	Bearing steel
Mechanical properties		
Density [g/cm ³]	3,2	7,9
Hardness	1 600 HV10	700 HV10
Modulus of elasticity [kN/mm ²]	310	210
Thermal expansion [10 ⁻⁶ /K]	3	12
Electrical properties (at 1 MHz)		
Electrical resistivity [Ωm]	10 ¹² (Insulator)	0,4 × 10 ⁻⁶ (Conductor)
Dielectric strength [kV/mm]	15	–
Relative dielectric constant	8	–

Cage materials

Phenolic resin

Cotton fabric reinforced phenolic resin is a lightweight material. Cages made of this material can withstand heavy inertial forces and operating temperatures up to 120 °C (250 °F). The material tends to absorb oil, assisting the lubrication of the cage / rolling element contact and providing a safety margin for run down, should there be an interruption of lubricant supply.

Cotton fabric reinforced phenolic resin is the standard cage material for super-precision angular contact ball bearings.

Polyamide 66

Polyamide 66 (PA66), with or without glass fibre reinforcement, is characterized by a favourable combination of strength and elasticity. Due to its excellent sliding properties on lubricated steel surfaces and the superior finish of the contact surfaces, PA66 cages reduce friction, frictional heat and wear. PA66 can be used at operating temperatures up to 120 °C (250 °F). However, some synthetic oils and greases with a synthetic oil base and lubricants containing EP additives, when used at high temperatures, can have a detrimental effect on PA66 cages. For information about the suitability of cages, refer to *Cages and Cage materials* in the SKF catalogue *Rolling bearings*, or visit skf.com.

PA66 is the standard cage material for many super-precision cylindrical roller bearings and angular contact thrust ball bearings.

Polyetheretherketone

Glass or carbon fibre reinforced polyetheretherketone (PEEK) is popular for demanding applications where there are either high speeds or high temperatures or a need for chemical resistance. The maximum temperature for high-speed use is limited to 150 °C (300 °F) as this is the softening temperature of the polymer. The material does not show signs of ageing by temperature or oil additives up to 200 °C (390 °F).

PEEK is the standard cage material for some super-precision angular contact ball and for high-speed design cylindrical roller bearings.

Brass

Brass is unaffected by most common bearing lubricants, including synthetic oils and greases, and can be cleaned using normal organic solvents. Brass cages can be used at operating temperatures up to 250 °C (480 °F).

Machined brass cages are used in a number of super-precision double row cylindrical roller bearings and double direction angular contact thrust ball bearings and are standard for large super-precision angular contact ball bearings ($d \geq 300$ mm).

Other cage materials

In addition to the materials described above, SKF super-precision bearings for special applications can be fitted with cages made of other engineered polymers, light alloys or silver-plated steel. For information about alternative cage materials, contact the SKF application engineering service.

Seal materials

Seals integrated in SKF super-precision bearings are typically made of sheet steel reinforced elastomers.

Acrylonitrile-butadiene rubber

Acrylonitrile-butadiene rubber (NBR) is the "universal" seal material. This copolymer, manufactured from acrylonitrile and butadiene, has good resistance to the following media:

- most mineral oils and greases with a mineral oil base
- normal fuels, such as petrol, diesel and light heating oils
- animal and vegetable oils and fats
- hot water

The permissible operating temperature range is -40 to $+100$ °C (-40 to $+210$ °F). The seal lip can tolerate dry running within this temperature range for short periods. Temperatures up to 120 °C (250 °F) can be tolerated for brief periods. At higher temperatures, the material hardens.

Fluoro rubber

Fluoro rubbers (FKM) are characterized by their high thermal and chemical resistance. Their resistance to ageing and ozone is very good and their gas permeability is very low. They have exceptionally good wear characteristics even under harsh environmental conditions. The permissible operating temperature range is -30 to $+230$ °C (-20 to $+445$ °F). The seal lip can tolerate dry running within this temperature range for short periods.

FKM is resistant to oils and hydraulic fluids, fuels and lubricants, mineral acids and aliphatic as well as aromatic hydrocarbons which would cause seals made of other materials to fail. FKM should not be used in the presence of esters, ethers, ketones, certain amines and hot anhydrous hydrofluorides.

Seals made of FKM exposed to an open flame or temperatures above 300 °C (570 °F) are a health and environmental hazard! They remain dangerous even after they have cooled. Read and follow the safety precautions (→ **WARNING**).

WARNING: HAZARDOUS FUMES

Safety precautions for fluoro rubber

Fluoro rubber (FKM) is very stable and harmless up to normal operating temperatures of 200 °C (390 °F). However, if exposed to temperatures above 300 °C (570 °F), such as fire or the open flame of a cutting torch, FKM seals give off hazardous fumes. These fumes can be harmful if inhaled, as well as if they contact the eyes. In addition, once the seals have been heated to such temperatures, they are dangerous to handle even after they have cooled. Therefore, they should never come in contact with the skin.

If it is necessary to handle bearings with seals that have been subjected to high temperatures, such as when dismantling the bearing, the following safety precautions should be observed:

- Always wear protective goggles, gloves and appropriate breathing apparatus.
- Place all of the remains of the seals in an airtight plastic container marked with a symbol for "material will etch".
- Follow the safety precautions in the material safety data sheet (MSDS).

If there is contact with the seals, wash hands with soap and plenty of water and, if contact has been made with the eyes, flush the eyes with plenty of water and consult a doctor immediately. If the fumes have been inhaled, consult a doctor immediately.

The user is responsible for the correct use of the product during its service life and its proper disposal. SKF takes no responsibility for the improper handling of FKM seals, or for any injury resulting from their use.

Design considerations

The majority of super-precision bearings are used in machine tool spindles. Most of the information required when designing a bearing arrangement for maximum bearing performance can be found in the following sections.

Bearing arrangements

A bearing system, which is typically used to support a rotating shaft, generally requires two bearing arrangements. Depending on the requirements, such as stiffness or load directions, a bearing arrangement consists of one or more (matched) bearings.

Bearing arrangements for heavy loads

Lathe spindles are typically used to cut metals at relatively slow speeds. Depth of cut and feed rates are usually pushed to the limit depending on the required surface finish. In a lathe, power is normally transmitted to the spindle by a pulley or gears, resulting in heavy radial loads at the non-tool end. On the tool end of the spindle, where there are heavy combined loads, a high degree of rigidity and high load carrying capacity are important operational requirements.

In a lathe spindle, it is common to have a double row cylindrical roller bearing in combination with a double direction angular contact thrust ball bearing at the tool end and a double row cylindrical roller bearing at the non-tool end (→ **fig. 10**).

The outside diameter of the thrust bearing housing washer is manufactured to a special tolerance. This tolerance enables the bearing to be radially free when mounted in a housing of appropriate bore diameter tolerance for the adjacent double row cylindrical roller bearing. This clearance is sufficient to relieve the thrust bearing from carrying significant radial load. This bearing arrangement provides a long calculated life and a high degree of rigidity and stability, both essential to the manufacture of good quality workpieces.

A good rule of thumb is to have the distance between the tool end and non-tool end bearing centres in the range 3 to 3,5 times the bore diameter of the bearing(s) at the tool end. This rule is particularly important when heavy loads are involved. For additional information, refer to *System rigidity* (→ **page 66**).

1

Fig. 10

Belt-driven CNC lathe spindle for large diameter bar stock

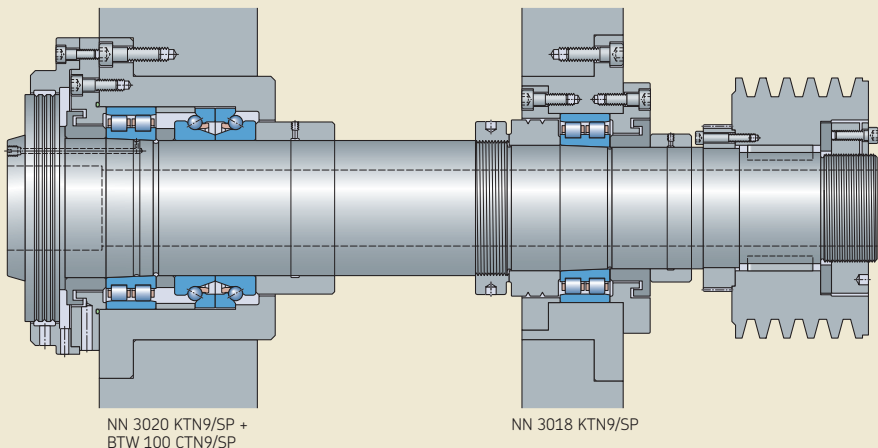

Principles of bearing selection and application

Additional arrangements for CNC lathes and conventional milling machines (→ **figs. 11** and **12**) and live centres (→ **fig. 13**) are provided.

Fig. 11

Belt-driven CNC lathe spindle

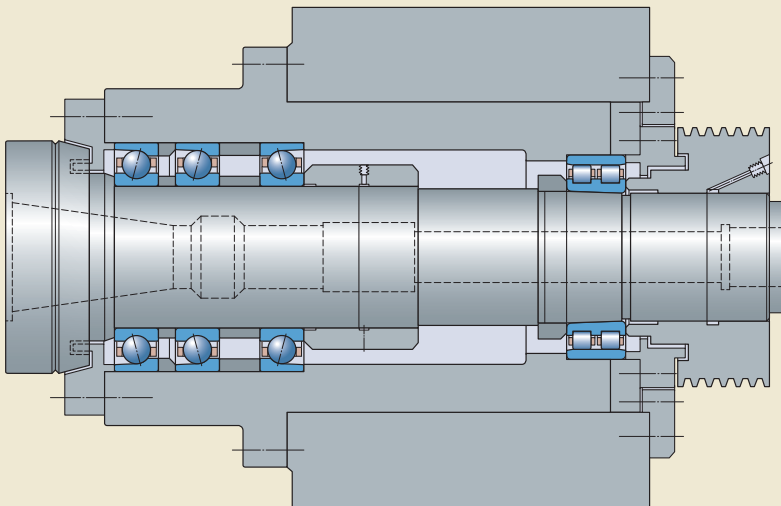

7016 ACD/P4ATBTA

NN 3014 KTN/SP

Fig. 12

Conventional milling machine spindle

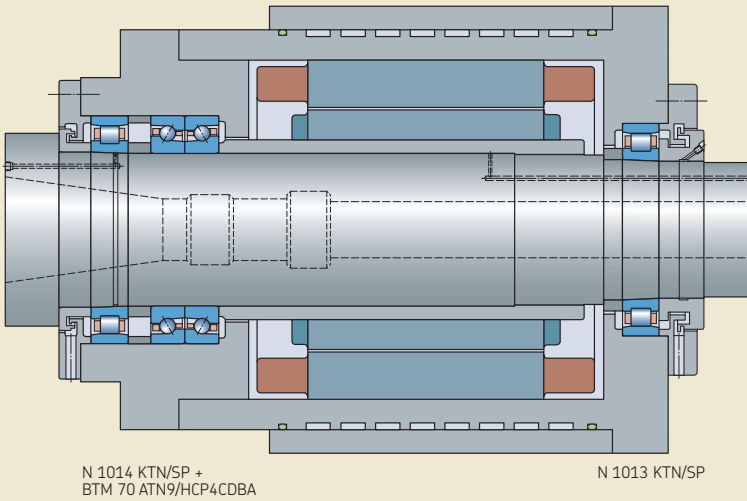

1

Fig. 13

Live centre spindle

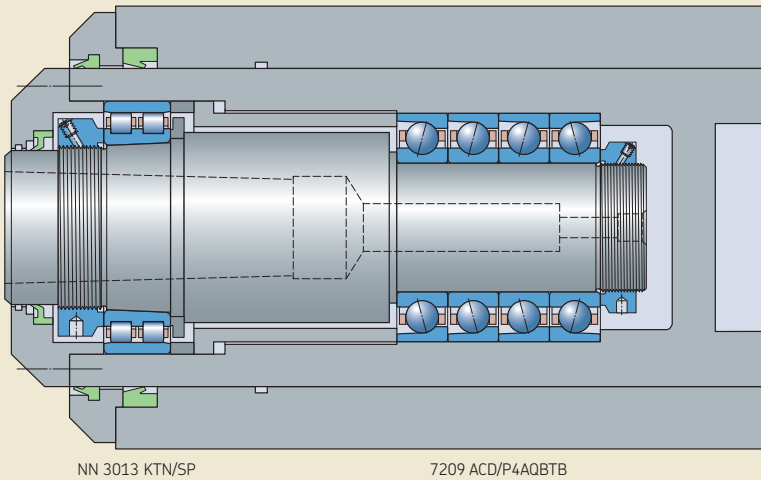

Principles of bearing selection and application

For applications where available space is limited, super-precision angular contact ball bearings in the 718 or 719 series may be more suitable (→ **figs. 14** and **15**).

Fig. 14

Multispindle drilling head

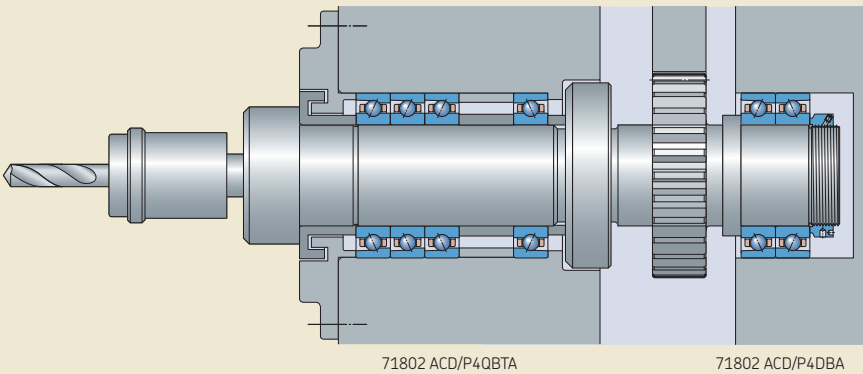
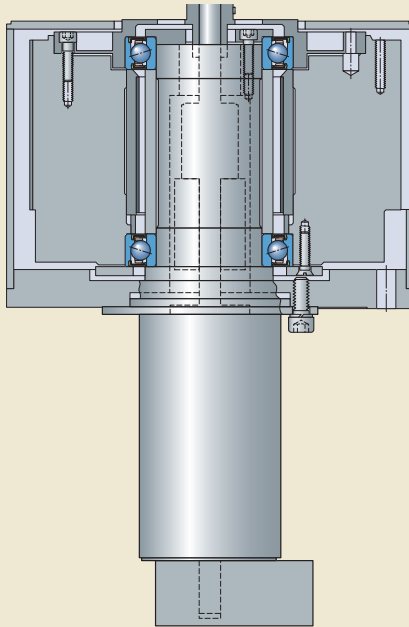

Fig. 15

Unit for detecting defects on silicon wafer chips



S71906 CD/P4ADBA

Bearing arrangements for greater rigidity and higher speeds

When higher speeds are required, as is the case for high-speed machining centres ($A > 1\,200\,000$ mm/min), there is typically a compromise between rigidity and load carrying capacity. In these applications, the spindle is usually driven directly by a motor (motorized spindles or electro-spindles), or through a coupling. Therefore, there are no radial loads on the non-tool end as is the case with a belt driven spindle. Consequently, single row angular contact ball bearings mounted in sets and single row cylindrical roller bearings are frequently used (→ **fig. 16**). In this bearing system, the tool end bearing set is axially located, while the cylindrical roller bearing on the non-tool end accommodates thermal expansion of the spindle shaft relative to the housing within the bearing.

Other arrangement examples for spindles in high-speed machining centres and milling machines are shown in **figs. 17** and **18**.

If enhanced performance is required, SKF recommends using hybrid bearings equipped

with rolling elements made of bearing grade silicon nitride (Si_3N_4).

Fig. 16

Electro-spindle in a horizontal machining centre

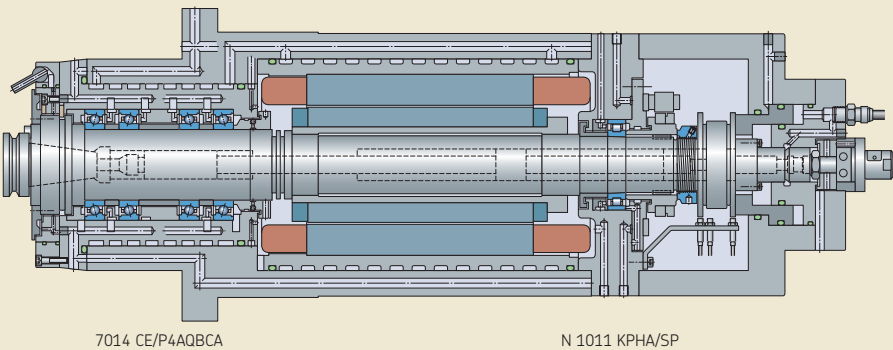
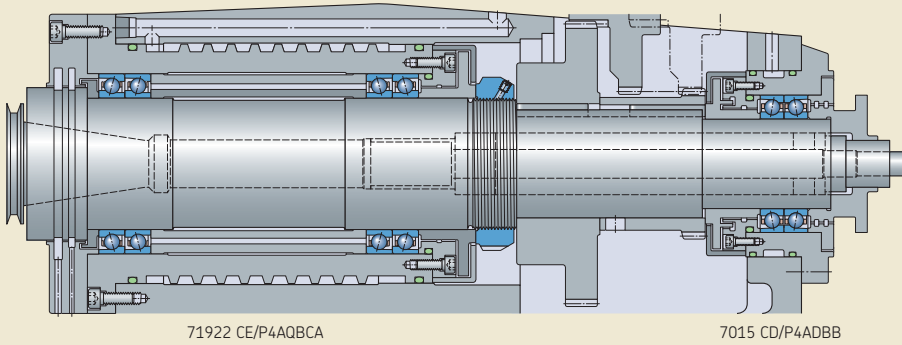

Fig. 17

Spindle in a horizontal machining centre



1

Fig. 18

Electro-spindle in a high-speed metal cutting machine

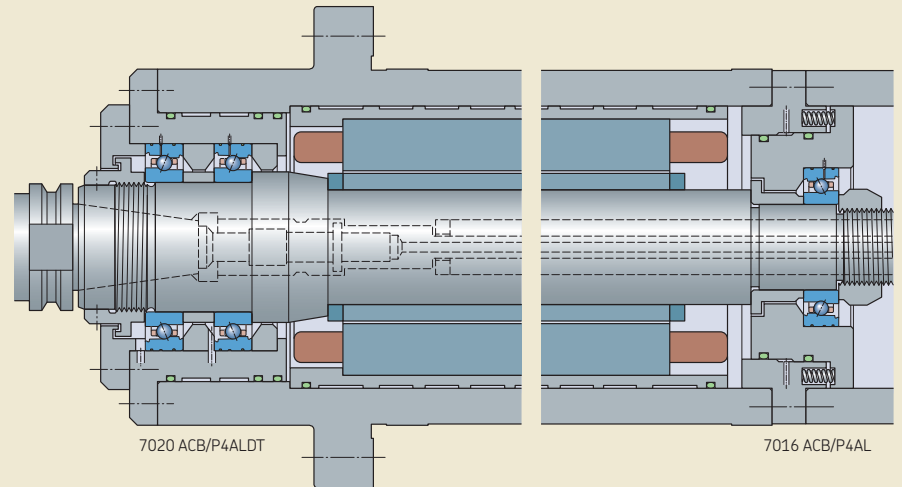

Bearing arrangements for maximum speed

When sets of angular contact ball bearings are mounted with a fixed preload (without springs), that preload tends to increase when in service due to differential thermal expansion. As speeds rise the significance of this effect tends to increase.

To avoid the damaging effects of excessive preload, particularly in exceptionally high speed applications ($A > 2\,000\,000$ mm/min), it is quite common to use angular contact ball bearings preloaded by springs (→ **fig. 19**). Springs control preload independent of the effects of relative thermal expansion and minimize the amount of frictional heat generated in the bearings.

An even better solution than springs is to preload angular contact ball bearings with a hydraulic system. A hydraulic system adjusts the amount of preload according to the speed of the spindle to obtain the best combination of rigidity, frictional heat and bearing service life.

Fig. 19

Electro-spindle for an internal grinding machine

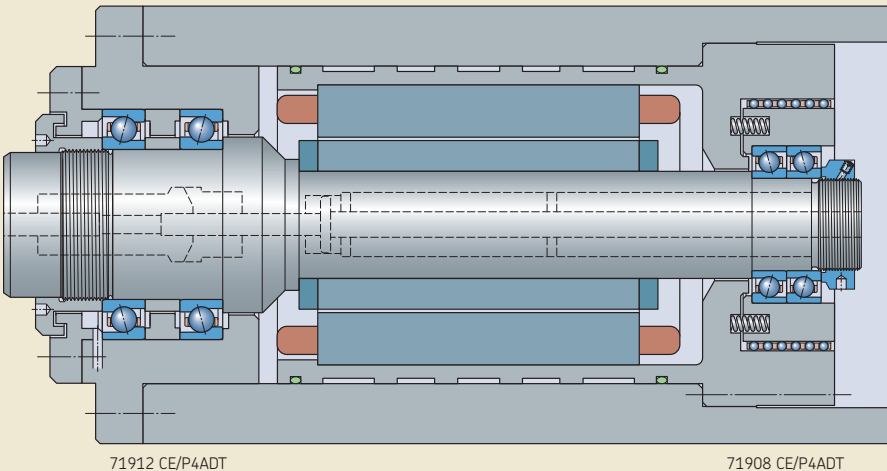

System rigidity

System rigidity in machine tool applications is extremely important because deflection under load has a major impact on machining accuracy. Bearing stiffness is only one factor that influences system rigidity. Others include:

- shaft stiffness
- tool overhang
- housing stiffness
- number and position of bearings and the influence of fits

Some general guidelines for designing high-speed precision applications include:

- Select the largest possible shaft diameter.
- Minimize the distance between the tool end bearing position and the spindle nose.
- Keep the distance between the two bearing sets short (→ **fig. 20**). A guideline for the spacing is:

$$l \approx 3 \dots 3,5 d$$

where

l = distance between the first tool end bearing row and the rearmost non-tool end bearing row

d = tool end bearing bore diameter

Diagram 9 provides an overview of the relative stiffness of different bearing systems. For details about the bearing series, refer to *Designation system* in the relevant product chapter. The comparison is based on preloaded bearings with 100 mm bore on the tool end and 90 mm bore on the non-tool end. These guideline values cannot substitute for precise system rigidity calculations. For advanced system analysis, contact the SKF application engineering service.

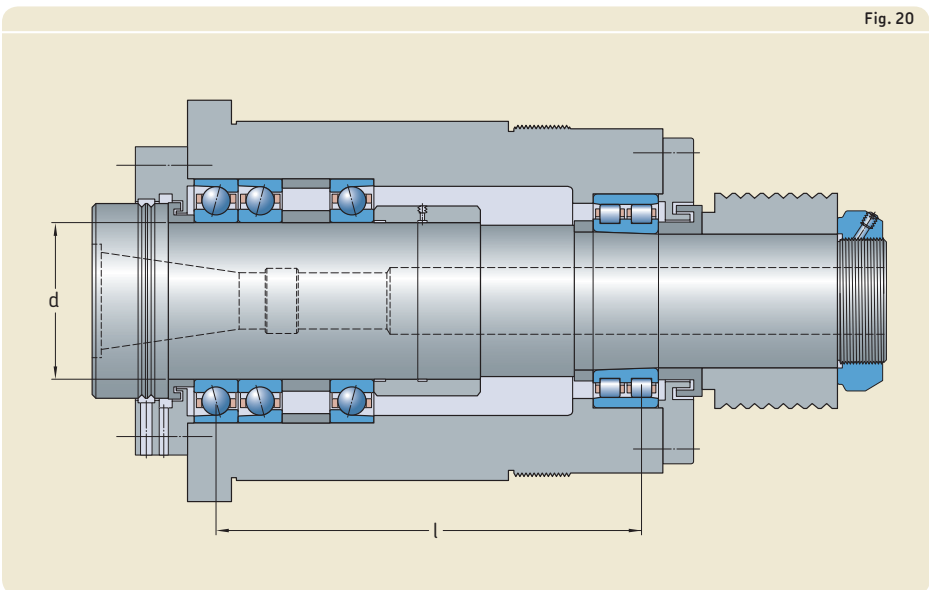
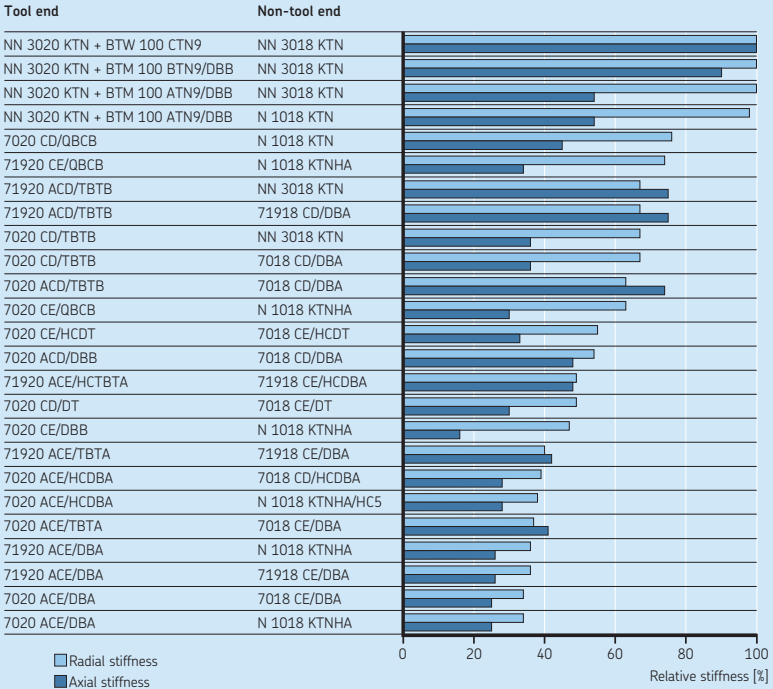

Fig. 20

Relative stiffness of typical spindle bearing systems



Angular contact ball bearings

- AC** 25° contact angle
- C** 15° contact angle
- D** High-capacity D design
- E** High-speed E design
- HC** Ceramic balls
- DB** Two bearings, back-to-back <>
- DT** Two bearings, tandem <<
- TBT** Three bearings, back-to-back and tandem <<>
- QBC** Four bearings, tandem back-to-back <<>>
- A** Extra light or light preload
- B** Light or moderate preload

Cylindrical roller bearings

- K** Tapered bore
- TN** PA66 cage, roller centred
- TNHA** Glass fibre reinforced PEEK cage, outer ring centred
- HCS** Ceramic rollers

Double direction angular contact thrust ball bearings

- A** 30° contact angle
- B** 40° contact angle
- C** 60° contact angle
- TN9** Glass fibre reinforced PA66 cage, ball centred

Bearing stiffness

The stiffness of a rolling bearing is characterized by the magnitude of the elastic deformation (deflection) in the bearing under load. It is expressed as the ratio of load to deflection and depends on the bearing type, design and size. The most important parameters are:

- type of rolling elements; roller bearings have a higher degree of stiffness than ball bearings because of the contact conditions between the rolling elements and raceways
- rolling element material (→ **diagram 10**)
- number and size of rolling elements
- contact angle (→ **diagram 11**)
- preload class (→ **diagram 12**)

Bearing stiffness can be further enhanced by applying a preload (→ *Bearing preload*, **page 90**). Preloading bearings is standard practice in machine tool applications.

A loose fit on a mating component can have a negative influence on the stiffness of a bearing arrangement. However, a loose housing fit may be necessary for bearing arrangements

using angular contact ball bearings in the non-locating position. Typically the non-locating bearing position is on the non-tool end of a spindle shaft and, therefore, the influence on system rigidity for the tool end is limited. If a high degree of stiffness is also desired for the non-tool end, a cylindrical roller bearing with a tapered bore should be used. This arrangement can accommodate axial displacement of the spindle shaft relative to the housing within the bearing and enables an interference fit for both the inner and outer rings.

Diagram 10

Radial stiffness of spring preloaded bearings

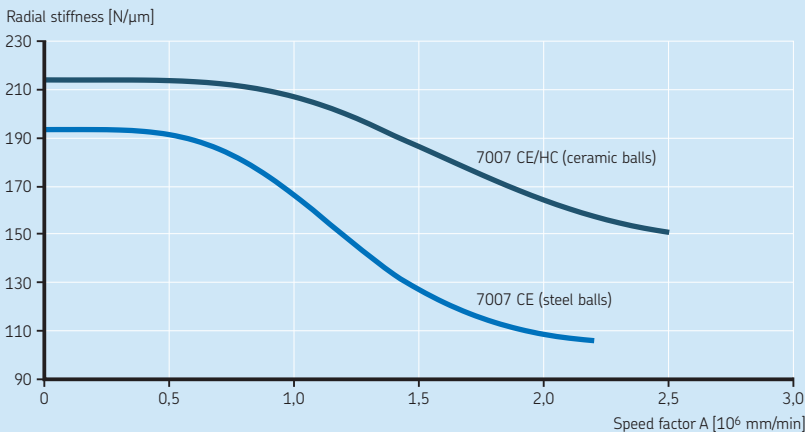

Diagram 11

Axial displacement of back-to-back bearing sets with different contact angles

1

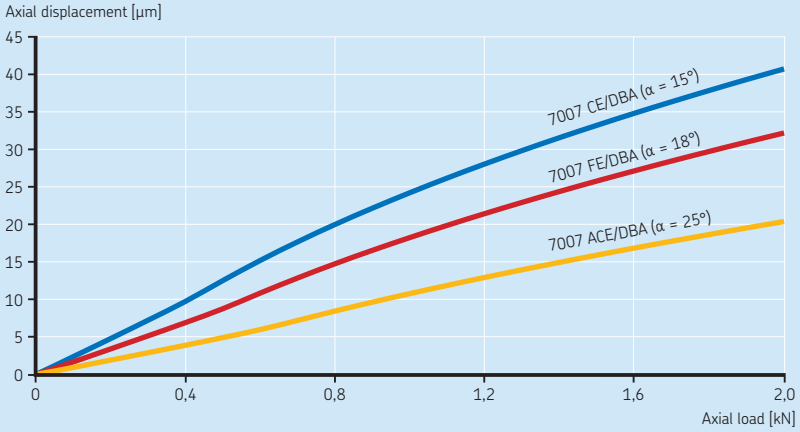
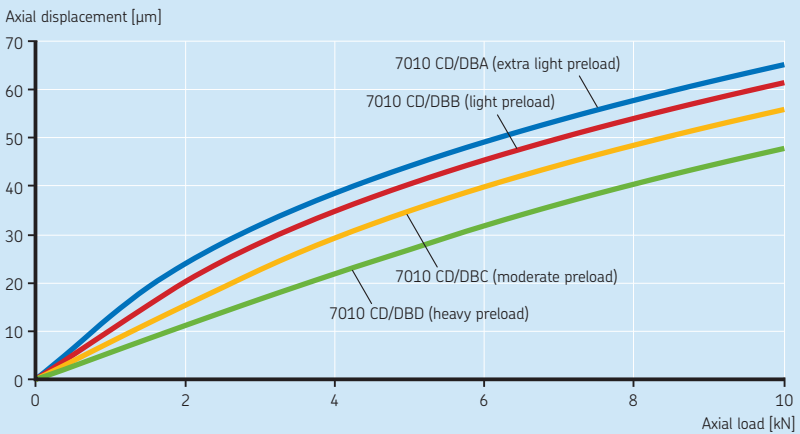

Diagram 12

Axial displacement of back-to-back bearing sets with different preload



Radial location of bearings

If the load carrying capacity of a bearing is to be fully exploited, its rings or washers should be fully supported around their complete circumference and across the entire width of the raceway. The support, which should be firm and even, can be provided by a cylindrical or tapered seat, as appropriate or, for thrust bearing washers, by a flat (plane) support surface. This means that bearing seats should be manufactured to adequate tolerance classes and uninterrupted by grooves, holes or other features, unless the seat is prepared for the oil injection method. This is particularly important for super-precision bearings that have relatively thin rings which tend to reproduce the shape of the shaft or housing seat. In addition, the bearing rings should be reliably secured to prevent them from turning on or in their seats under load.

In general, satisfactory radial location and adequate support can only be obtained when the rings are mounted with an appropriate degree of interference. Inadequately or incorrectly secured bearing rings generally cause damage to the bearing and mating components. However, when axial displacement (as with a non-locating bearing) or easy mounting and dismounting are required, an interference fit cannot always be used. In cases where a loose fit is necessary, but an interference fit would normally be required, special precautions are necessary to limit the fretting wear that inevitably results from creep (the bearing ring turning on its seat). This can be done, for example, by surface hardening the bearing seat and abutments.

Recommended shaft and housing fits

Diameter tolerances for bearing seats

Shaft and housing seats for super-precision angular contact ball bearings, cylindrical roller bearings and double direction angular contact thrust ball bearings should be manufactured to the diameter tolerances recommended in:

- **table 7** for shaft seat tolerances
- **table 8** (→ **page 72**) for housing seat tolerances

For recommendations for other super-precision bearings, refer to the relevant section of:

- angular contact thrust ball bearings for screw drives (→ *Associated components*, **page 349**)
- axial-radial cylindrical roller bearings (→ *Design considerations*, **page 324**)

Values of appropriate ISO tolerance classes for super-precision bearings are listed in:

- **table 9** (→ **page 73**) for shaft tolerances
- **table 10** (→ **page 73**) for housing tolerances

The location of the commonly used tolerance classes relative to the bearing bore and outside diameter surface are shown in **fig. 21**.

Table 7

Bearing type	Shaft diameter		Tolerance class ¹⁾		Deviations	
	over	incl.	Bearings to tolerance class		high	low
	mm		P4, P4A, P4C, SP	P2, PA9A, UP	µm	
Angular contact ball bearings						
with rotating outer ring load	–	400	h4	h3	–	–
with rotating inner ring load	–	30	–	–	+1	–3
	30	80	–	–	+2	–3
	80	120	–	–	+3	–3
	120	180	–	–	+4	–4
	180	250	–	–	+5	–5
	250	315	–	–	+6	–6
	315	400	–	–	+6,5	–6,5
Cylindrical roller bearings						
with a cylindrical bore	–	40	js4	–	–	–
	40	280	k4	–	–	–
	280	500	k4 ²⁾	–	–	–
	500	–	Contact the SKF application engineering service.			
Double direction angular contact thrust ball bearings	–	200	h4	h3	–	–

For hollow shafts, when $A > 1\,000\,000$ mm/min, contact the SKF application engineering service.
¹⁾ All ISO tolerance classes are valid with the envelope requirement (such as h4 \oplus) in accordance with ISO 14405-1.
²⁾ General guideline only. SKF recommends contacting the SKF application engineering service.

Fig. 21

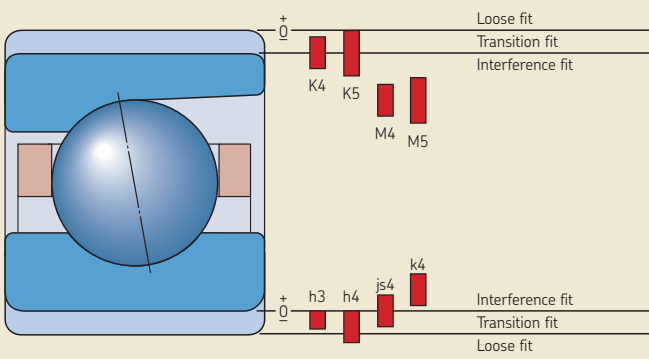

Table 8

Diameter tolerances for bearing seats in cast iron and steel housings

Bearing type	Conditions	Housing bore		Tolerance class ¹⁾		Deviations	
		over	incl.	Bearings to tolerance class P4, P4A, P2, PA9A, P4C, SP UP		high	low
–	–	mm		–		µm	
Angular contact ball bearings	Locating bearings, axial displacement of outer ring unnecessary	–	18	–	–	+4	–1
		18	30	–	–	+5	–1
		30	50	–	–	+6	–1
		50	80	–	–	+7	–1
		80	120	–	–	+7	–3
		120	180	–	–	+9	–3
	Non-locating bearings, axial displacement of outer ring desirable	180	250	–	–	+10	–4
		250	315	–	–	+12	–4
		315	400	–	–	+13	–5
		400	500	–	–	+14	–6
		–	18	–	–	+7	+2
		18	30	–	–	+8	+2
		30	50	–	–	+9	+2
		50	80	–	–	+10	+2
80	120	–	–	+13	+3		
120	180	–	–	+16	+4		
180	250	–	–	+19	+5		
250	315	–	–	+21	+5		
315	400	–	–	+24	+6		
400	500	–	–	+27	+7		
Cylindrical roller bearings	Rotating outer ring load	–	500	M5	M4	–	–
	Light to normal loads ($P \leq 0,1 C$)	–	900	K5	K4	–	–
	Heavy loads ($0,1 C < P \leq 0,15 C$), rotating outer ring loads	–	900	M5	M4	–	–
Double direction angular contact thrust ball bearings		–	315	K5	K4	–	–

¹⁾ All ISO tolerance classes are valid with the envelope requirement (such as M4[Ⓔ]) in accordance with ISO 14405-1.

Table 9

Values of ISO tolerance classes for shafts

Shaft diameter d		Tolerance classes h3 ^(E)		h4 ^(E)		js4 ^(E)		k4 ^(E)	
Nominal over	incl.	Deviations high low		Deviations high low		Deviations high low		Deviations high low	
mm		μm							
-	3	0	-2	0	-3	+1,5	-1,5	+3	0
3	6	0	-2,5	0	-4	+2	-2	+5	+1
6	10	0	-2,5	0	-4	+2	-2	+5	+1
10	18	0	-3	0	-5	+2,5	-2,5	+6	+1
18	30	0	-4	0	-6	+3	-3	+8	+2
30	50	0	-4	0	-7	+3,5	-3,5	+9	+2
50	80	0	-5	0	-8	+4	-4	+10	+2
80	120	0	-6	0	-10	+5	-5	+13	+3
120	180	0	-8	0	-12	+6	-6	+15	+3
180	250	0	-10	0	-14	+7	-7	+18	+4
250	315	0	-12	0	-16	+8	-8	+20	+4
315	400	0	-13	0	-18	+9	-9	+22	+4
400	500	-	-	-	-	-	-	+25	+5

Table 10

Values of ISO tolerance classes for housings

Housing bore diameter D		Tolerance classes K4 ^(E)		K5 ^(E)		M4 ^(E)		M5 ^(E)	
Nominal over	incl.	Deviations high low		Deviations high low		Deviations high low		Deviations high low	
mm		μm							
10	18	+1	-4	+2	-6	-5	-10	-4	-12
18	30	0	-6	+1	-8	-6	-12	-5	-14
30	50	+1	-6	+2	-9	-6	-13	-5	-16
50	80	+1	-7	+3	-10	-8	-16	-6	-19
80	120	+1	-9	+2	-13	-9	-19	-8	-23
120	180	+1	-11	+3	-15	-11	-23	-9	-27
180	250	0	-14	+2	-18	-13	-27	-11	-31
250	315	0	-16	+3	-20	-16	-32	-13	-36
315	400	+1	-17	+3	-22	-16	-34	-14	-39
400	500	0	-20	+2	-25	-18	-38	-16	-43
500	630	0	-22	0	-32	-26	-48	-26	-58
630	800	0	-25	0	-36	-30	-55	-30	-66
800	1000	0	-28	0	-40	-34	-62	-34	-74

Selecting bearings to achieve preferred fits

Angular contact ball bearings and cylindrical roller bearings operating under normal loads and moderate speeds, should be selected to attain the interference/clearance values listed in:

- **table 11** for shaft fits
- **table 12** for housing fits

Diameter deviations of the bearings are provided on the package of super-precision angular contact ball bearings.

For extreme conditions, such as very high speeds or heavy loads, contact the SKF application engineering service.

For double direction angular contact thrust ball bearings (BTM and BTW series), the outside diameter of the housing washer is manufactured to tolerances such that sufficient radial clearance in the housing seat is obtained. Therefore, for bearings in the BTW and BTM series mounted adjacent to an appropriate cylindrical roller bearing in the same housing seat, tolerances tighter than those recommended in **table 8** (→ **page 72**) should not be used. For additional information, refer to *Double direction angular contact thrust ball bearings* (→ **page 301**).

Table 11

Preferred shaft fits			
Bearing type	Bearing bore		Interference
	over	incl.	
–	mm		µm
Angular contact ball bearings	–	50	0 to 2
	50	80	1 to 3
	80	120	1 to 4
	120	180	2 to 5
	180	250	2 to 6
	250	315	2 to 7
	315	400	3 to 8

Table 12

Preferred housing fits					
Bearing type	Bearing outside diameter		Clearance		Interference
	over	incl.	locating	non-locating	
–	mm		µm		µm
Angular contact ball bearings	–	50	2 to 6	6 to 10	–
	50	80	2 to 6	6 to 11	–
	80	120	2 to 7	8 to 13	–
	120	180	2 to 9	10 to 16	–
	180	250	4 to 10	12 to 19	–
	250	315	4 to 10	14 to 22	–
	315	500	5 to 12	16 to 25	–
Cylindrical roller bearings	–	460	–	–	0 to 2

Accuracy of seats and abutments

Geometrical and running accuracy

Maximum running accuracy, high speeds and low operating temperatures can only be achieved, even with super-precision bearings, if the mating parts and other associated components are made with equal precision as the bearings. Deviations from geometric form of associated seats and abutments should therefore be kept to a minimum when machining mating parts. Form and position recommendations in accordance with ISO 1101 are provided in **table 13** (→ **page 76**).

Thin-walled bearing rings adapt themselves to the form of their seat. Any errors of form on the shaft or housing seat can therefore affect the bearing raceways and bearing performance, e.g. angular misalignment of one bearing ring relative to the other, can cause loss of running accuracy, load concentration and high operating temperatures, particularly at high speeds.

The numerical values of IT tolerance grades in accordance with ISO 286-1 are listed in **table 14** (→ **page 77**).

Surface roughness

The surface roughness of a bearing seat does not have the same degree of influence on bearing performance as the dimensional and geometrical tolerances of the seat. However, obtaining a desired interference fit depends on the roughness of the mating surfaces, which is directly proportional to fit accuracy. Guideline values for the mean surface roughness R_a are listed in **table 15** (→ **page 77**) for different bearing tolerance classes. These recommendations apply to ground seats.

Geometrical tolerances for bearing seats on shafts and in housings

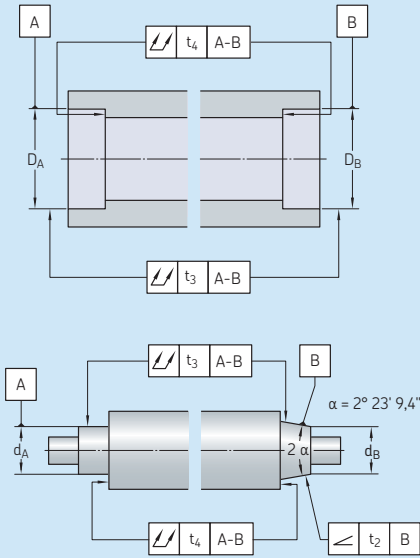

Surface Characteristic	Symbol	Tolerance zone	Permissible deviations Bearings to tolerance class P4, P4A, P4C, SP	
Cylindrical seat Total radial run-out	Ⓜ	t_3	IT2/2	IT1/2
Flat abutment Total axial run-out	Ⓜ	t_4	IT1	IT0
Angularity	Ⓜ	t_2	IT3/2	IT2/2

Table 14

Values of ISO tolerance grades

Nominal dimension		Tolerance grades		IT2	IT3	IT4	IT5
over	incl.	IT0 max.	IT1				
mm		μm					
–	3	0,5	0,8	1,2	2	3	4
3	6	0,6	1	1,5	2,5	4	5
6	10	0,6	1	1,5	2,5	4	6
10	18	0,8	1,2	2	3	5	8
18	30	1	1,5	2,5	4	6	9
30	50	1	1,5	2,5	4	7	11
50	80	1,2	2	3	5	8	13
80	120	1,5	2,5	4	6	10	15
120	180	2	3,5	5	8	12	18
180	250	3	4,5	7	10	14	20
250	315	4	6	8	12	16	23
315	400	5	7	9	13	18	25
400	500	6	8	10	15	20	27
500	630	–	9	11	16	22	32
630	800	–	10	13	18	25	36
800	1 000	–	11	15	21	28	40

Table 15

Surface roughness of bearing seats

Seat diameter		Recommended R_a value for ground seats		Housing bore	
over	incl.	Shaft		Bearings to tolerance class	
		P4, P4A, P4C, SP max.	P2, PA9A, UP	P4, P4A, P4C, SP max.	P2, PA9A, UP
mm		μm		μm	
–	80	0,2	0,1	0,4	0,4
80	250	0,4	0,2	0,4	0,4
250	500	0,8	0,4	0,8	0,8
500	800	0,8	0,8	0,8	0,8
800	1 000	0,8	0,8	1,6	1,6

Axial location of bearings

In general, an interference fit alone is inadequate to locate a bearing ring on a cylindrical seat. Under load, a bearing ring can creep on its seat. Some suitable means to secure the bearing axially is needed.

For a locating bearing, both rings should be secured axially on both sides.

For non-separable bearings in the non-locating position, the ring with an interference fit, typically the inner ring, should be secured axially on both sides. The other ring must be free to move axially on its seat to accommodate axial displacement.

Cylindrical roller bearings in the non-locating position are exceptions. The inner and outer rings of these bearings must be secured axially in both directions.

In machine tool applications, bearings at the tool end generally locate the shaft by transmitting the axial load from the shaft to the housing. In general, then, tool end bearings are located axially, while non-tool end bearings are axially free.

Locating methods

Lock nuts

Bearing inner rings that are mounted with an interference fit typically abut a shoulder on the shaft on one side. On the opposite side, they are normally secured by a precision lock nut (→ **fig. 22**).

Bearings with a tapered bore, mounted directly on a tapered shaft seat, are generally retained on the shaft by a spacer seated against a fixed abutment at the large end of the taper and a precision lock nut at the small end of the taper. The spacer width is adjusted to limit the drive-up distance of the bearing on its tapered seat.

For detailed information about precision lock nuts, refer to *Precision lock nuts* (→ **page 375**).

Spacer sleeves

Instead of integral shaft or housing shoulders, spacer sleeves or collars can be used between the bearing rings or between a bearing ring and an adjacent component (→ **fig. 23**). In these cases, the dimensional and form tolerances for abutments apply.

Fig. 22

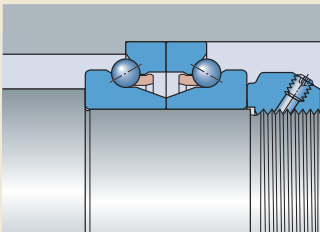
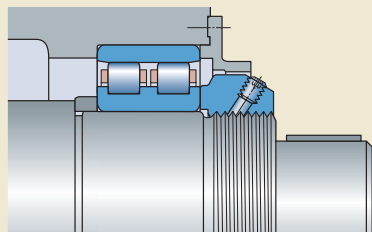

Fig. 23



Stepped sleeves

Another way to locate a bearing axially is to use a stepped sleeve (→ **fig. 24**) with a tight interference fit on the shaft. These sleeves are particularly suitable for super-precision bearing arrangements, as they have very small run-out and provide superior accuracy compared to threaded lock nuts. Therefore, stepped sleeves are typically used in very high-speed spindles where the accuracy provided by conventional locking devices may be inadequate.

For detailed information about stepped sleeves, refer to *Stepped sleeves* (→ **page 80**).

Housing covers

Bearing outer rings that are mounted with an interference fit typically abut a shoulder in the housing on one side. On the opposite side, they are normally located by a housing cover.

Housing covers and their securing screws can, in some cases, have a negative impact on bearing form and performance. If the wall thickness between the bearing seat and the bolt holes is too small, and/or the bolts are tightened too much, the outer ring raceway may deform. Bearings in the lightest ISO dimension series 18 and 19 are more susceptible to this than those in the ISO dimension series 10 or above.

It is advisable to use a larger number of small diameter bolts. Using only three or four bolts should be avoided because a small number of tightening points may produce lobes in the housing bore. This can result in noise, vibration, unstable preload or premature failure due to load concentrations. For complex spindle designs where space is limited, only thin-section bearings and a limited number of bolts may be possible. In these cases, SKF recommends an FEM (finite element method) analysis to accurately predict deformation.

As a guideline to achieve an appropriate clamping force between the cover spigot end face and the side face of the bearing outer ring, the cover spigot length should be adjusted so that, before the bolts are tightened, the axial gap between the cover and the housing side face is between 15 and 20 μm per 100 mm housing bore diameter (→ **fig. 25**).

Fig. 24

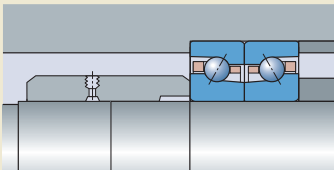
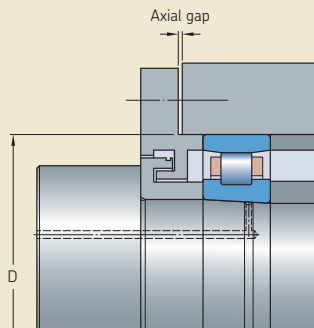

Fig. 25



Stepped sleeves

Stepped sleeves are pressure joints with two slightly different inside diameters that mate with a stepped shaft. An interference fit maintains the sleeve's position axially and determines its axial load carrying capacity. The stepped design of the fitting surface simplifies alignment during mounting but also facilitates dismounting when using the oil injection method.

Stepped sleeves do not create any stresses that might reduce the running accuracy of a shaft, but do enhance shaft stiffness. They are typically used in very high speed, lightly loaded applications where there are minimal shock loads. Compared to threaded lock nuts, stepped sleeves provide superior mounting accuracy, provided the sleeve and its seats are manufactured to the appropriate specifications, and the sleeve is mounted correctly.

SKF does not supply or manufacture stepped sleeves, but design recommendations and suitable dimensions are provided on the pages that follow.

Designs

Stepped sleeves (→ **fig. 26**) can have either a conventional sleeve form (**a**) or they can be ring shaped (**b**). Ring-shaped stepped sleeves are typically used in applications where the sleeve will also be used to form part of a labyrinth seal (→ *Special stepped sleeve designs*, **page 84**).

In applications where there are relatively light axial loads, the end of the sleeve with the smaller diameter can have a loose fit on the shaft. However, if the oil injection method will be used to dismount the sleeve, the end of the sleeve with the loose fit should be sealed with an O-ring (**c**).

Fig. 26

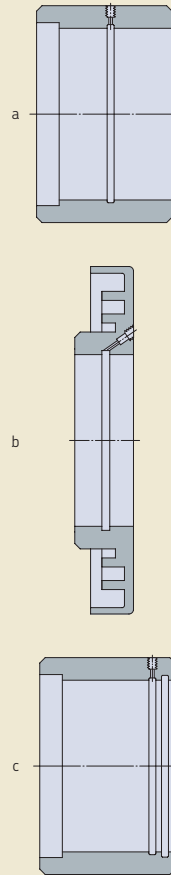

Recommended dimensions

Recommended dimensions are listed in:

- **table 16** (→ **page 82**) for stepped sleeves (without O-ring) and their seats (bearing arrangement example → **fig. 27**)
- **table 17** (→ **page 83**) for stepped sleeves with O-ring and their seats (bearing arrangement example → **fig. 28**)

When machining bores and shaft seats for stepped sleeves, it is very important that the actual degree of interference fit is as close as possible for both the major and minor diameters. Experience has shown that removal becomes much more difficult when there is even a small difference in interference.

Thin-walled hollow shafts may deform as a result of high contact pressures. Therefore, the sleeves for these shafts should have a relief closest to the bearing to avoid deformation of the bearing seat. The length of the relief should be 15 to 20% of the shaft diameter.

Fig. 27

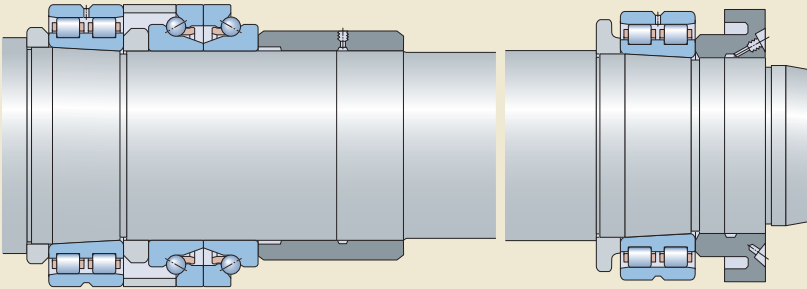

Fig. 28

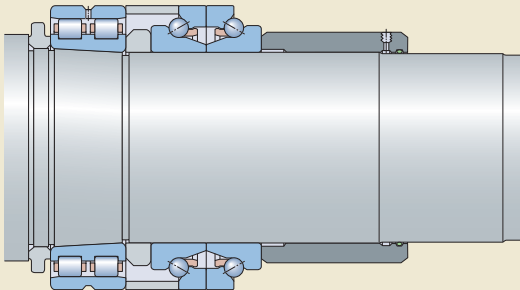
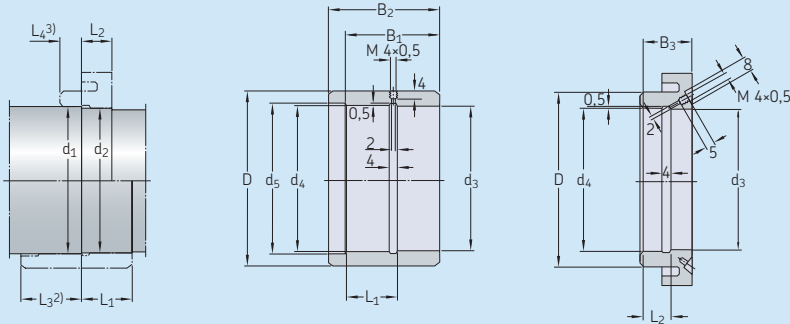

Table 16

Recommended dimensions for stepped sleeves and their seats



Dimensions Shaft		Stepped sleeve							Temperature difference ¹⁾			
d ₁ h4(E)	d ₂ h4(E)	d ₃ H4(E)	d ₄ H4(E)	d ₅ +0,5	D	B ₁	B ₂	B ₃	L ₁ ±0,1	L ₂ ±0,1	°C	°F
mm												
17	16,968	16,95	16,977	19	27	26	31	13	15	8,5	150	270
20	19,964	19,94	19,971	22	30	28	33	14	16	9	150	270
25	24,956	24,92	24,954	27	35	30	35	15	17	9,5	150	270
30	29,946	29,91	29,954	32	40	32	38	16	18	10	140	252
35	34,937	34,9	34,943	37	47	34	40	17	19	10,5	140	252
40	39,937	39,9	39,943	42	52	36	42	18	20	11	130	234
45	44,927	44,88	44,933	47	58	38	46	19	21	11,5	130	234
50	49,917	49,86	49,923	52	63	40	48	20	22	12	130	234
55	54,908	54,85	54,922	57	70	42	50	21	23	12,5	120	216
60	59,908	59,85	59,922	62	75	44	54	22	24	13	120	216
65	64,898	64,83	64,912	67	80	46	56	23	25	13,5	120	216
70	69,898	69,83	69,912	72	86	48	58	24	26	14	110	198
75	74,898	74,83	74,912	77	91	50	60	25	27	14,5	100	180
80	79,888	79,82	79,912	82	97	52	62	26	28	15	100	180
85	84,88	84,81	84,9	87	102	54	64	27	29	15,5	100	180
90	89,88	89,8	89,9	92	110	56	68	28	30	16	100	180
95	94,87	94,79	94,9	97	114	58	70	29	31	16,5	90	162
100	99,87	99,79	99,9	102	120	60	72	30	32	17	90	162
105	104,87	104,78	104,89	107	125	62	74	31	33	17,5	90	162
110	109,86	109,77	109,89	112	132	64	76	32	34	18	90	162
120	119,86	119,77	119,89	122	142	68	80	34	36	19	80	144
130	129,852	129,75	129,868	132	156	72	84	36	38	20	90	162
140	139,852	139,74	139,858	142	166	76	88	38	40	21	90	162
150	149,842	149,73	149,858	152	180	80	95	40	42	22	80	144
160	159,842	159,73	159,858	162	190	84	99	42	44	23	80	144
170	169,842	169,72	169,848	172	205	88	103	44	46	24	80	144
180	179,832	179,71	179,848	182	220	92	110	46	48	25	80	144
190	189,834	189,7	189,836	192	230	96	114	48	50	26	80	144
200	199,834	199,7	199,836	202	245	100	118	50	52	27	70	126

¹⁾ The difference in temperature between shaft and sleeve or ring when installing
²⁾ L₃ = length of stepped sleeve over diameter d₁ = L₁ + B₂ - B₁ - 4 [mm]
³⁾ L₄ = length of stepped ring over diameter d₁ = L₂ - 4 + recessed d₄ section [mm]

Table 17

Recommended dimensions for stepped sleeves with O-ring and their seats

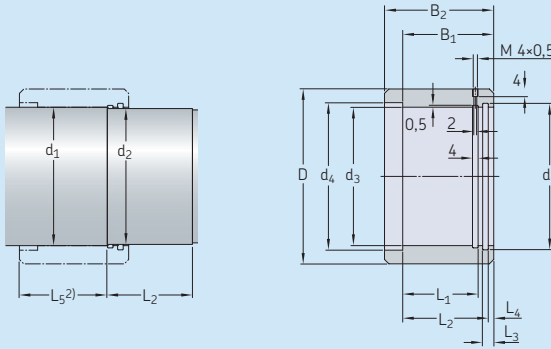

Dimensions Shaft		Stepped sleeve										Appropriate O-ring	Temperature difference ¹⁾	
d ₁ h4(E)	d ₂ f7(E)	d ₃ H4(E)	d ₄ +0,5	d ₅ H9	D	B ₁	B ₂	L ₁ ±0,1	L ₂ ±0,1	L ₃	L ₄ +0,2	-	°C	°F
mm														
17	16,95	16,977	19	20,6	27	26	31	17	22,9	6,5	3,1	16,3x2,4	150	270
20	19,95	19,971	22	23,6	30	28	33	19	24,9	6,5	3,1	19,3x2,4	150	270
25	24,9	24,954	27	29,5	35	30	35	21	26,1	7	3,9	24,2x3	150	270
30	29,9	29,954	32	34,5	40	32	38	24	28,1	7	3,9	29,2x3	140	252
35	34,9	34,943	37	39,5	47	34	40	26	30,1	7	3,9	34,2x3	140	252
40	39,9	39,943	42	44,5	52	36	42	28	32,1	7	3,9	39,2x3	130	234
45	44,9	44,933	47	49,5	58	38	46	32	34,1	7	3,9	44,2x3	130	234
50	49,9	49,923	52	54,5	63	40	48	34	36,1	7	3,9	49,2x3	130	234
55	54,9	54,922	57	59,5	70	42	50	36	38,1	7	3,9	54,2x3	120	216
60	59,9	59,922	62	64,5	75	44	54	40	40,1	7	3,9	60x3	120	216
65	64,85	64,912	67	69,5	80	46	56	42	42,1	7	3,9	65x3	120	216
70	69,85	69,912	72	74,5	86	48	58	42	44,1	8	3,9	69,5x3	110	198
75	74,85	74,912	77	79,5	91	50	60	44	46,1	8	3,9	74,5x3	100	180
80	79,85	79,912	82	84,5	97	52	62	46	48,1	8	3,9	79,5x3	100	180
85	84,85	84,9	87	89,5	102	54	64	48	50,1	8	3,9	85x3	100	180
90	89,85	89,9	92	94,5	110	56	68	52	52,1	8	3,9	90x3	100	180
95	94,85	94,9	97	99,5	114	58	70	54	54,1	8	3,9	94,5x3	90	162
100	99,85	99,9	102	104,5	120	60	72	54	56,1	9	3,9	100x3	90	162
105	104,85	104,89	107	109,5	125	62	74	56	58,1	9	3,9	105x3	90	162
110	109,85	109,89	112	114,5	132	64	76	58	60,1	9	3,9	110x3	90	162
120	119,85	119,89	122	124,5	142	68	80	62	64,1	9	3,9	120x3	80	144
130	129,8	129,868	132	134,4	156	72	84	66	68,1	9	3,9	130x3	90	162
140	139,8	139,858	142	144,4	166	76	88	70	72,1	9	3,9	140x3	90	162
150	149,8	149,858	152	159	180	80	95	73	72,6	13	7,4	149,2x5,7	80	144
160	159,8	159,858	162	169	190	84	99	77	76,6	13	7,4	159,2x5,7	80	144
170	169,8	169,848	172	179	205	88	103	81	80,6	13	7,4	169,2x5,7	80	144
180	179,8	179,848	182	189	220	92	110	88	84,6	13	7,4	179,2x5,7	80	144
190	189,8	189,836	192	199	230	96	114	92	88,6	13	7,4	189,2x5,7	80	144
200	199,8	199,836	202	209	245	100	118	96	92,6	13	7,4	199,2x5,7	70	126

¹⁾ The difference in temperature between shaft and sleeve when installing

²⁾ L₅ = length of stepped sleeve over diameter d₁ = L₁ + B₂ - B₁ - 4 [mm]

Material

SKF recommends using a heat-treatable steel with a yield point of at least 550 N/mm^2 . The mating surfaces of both the sleeve and shaft should be hardened and ground.

Axial load carrying capacity

The degree of the actual interference fit(s) determines the axial load carrying capacity of a stepped sleeve. When stepped sleeves are made to the recommended dimensions listed in **tables 16** and **17** (→ **pages 82** and **83**), the surface pressure between a solid or thick-walled hollow shaft and sleeve, and the axial retaining force per millimetre hub width can be estimated using the approximate values listed in **table 18**. Stepped sleeves with a loose fit for the smaller diameter, exert only half of the axial retaining force of stepped sleeves with an interference fit for both diameters.

When designing stepped sleeves, axial shock forces on the sleeve must also be taken into consideration. If necessary, a threaded nut

which is lightly tightened and which can also serve as a mounting aid can be used to secure the sleeve.

Special stepped sleeve designs

Stepped sleeves are used to secure and join other components. They enable hubs to be mounted and dismantled simply and can also replace various types of driver plates, dogs etc. The V-belt pulley shown in **fig. 29**, for example, is designed as a stepped sleeve with an integral labyrinth seal. In this case, the sleeve not only locates the bearing axially, it is also used to transmit torque.

Fig. 29

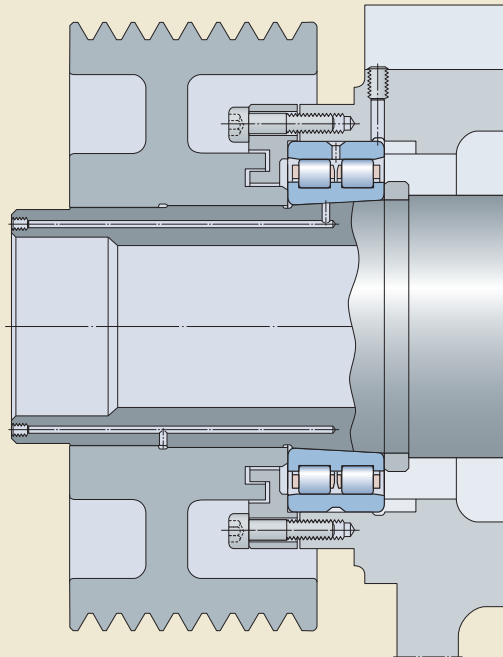

Table 18

Approximate surface pressure and axial retaining force of stepped sleeves¹⁾

Approximate shaft diameter d	Approximate surface pressure	Approximate axial retaining force per mm hub width
mm	N/mm ²	N/mm
30	40	300
100	35	550
200	22	1 000

¹⁾ When made to the recommended dimensions listed in tables 16 and 17 (→ pages 82 and 83).

Installation

The following procedure can be used to install stepped sleeves. If stepped sleeves are to be installed against bearings that are already greased, care should be taken that the injected oil / mounting fluid does not mix with the grease and impair its lubricating properties.

- 1 Heat the sleeve to obtain the required temperature difference listed in **tables 16** and **17** (→ **pages 82** and **83**).
- 2 Push the sleeve onto the shaft seat.
- 3 After the sleeve has cooled, inject oil or an SKF mounting fluid between the sleeve and shaft using suitable oil injection equipment (→ **fig. 30** and *Oil injection equipment and pressure media*). To avoid local stress peaks, the oil should be injected slowly and the oil pressure regulated.
- 4 Use a hydraulic nut and suitable distance sleeve to bring the sleeve to its final position (→ **fig. 30**). When using a hydraulic nut, the force of the nut against the bearing arrangement can be controlled by the oil pressure. As the sleeve “floats” on the oil film, any stresses produced during the shrinking of the sleeve (produced as the sleeve cooled) are relieved and the components can be correctly positioned relative to each other. When the required axial force has been obtained, the final position is reached.
- 5 With the tool still in position, release the oil pressure between the mating surfaces and allow the oil to drain. Normally it takes about 24 hours before the sleeve can support its full load.

Fig. 30

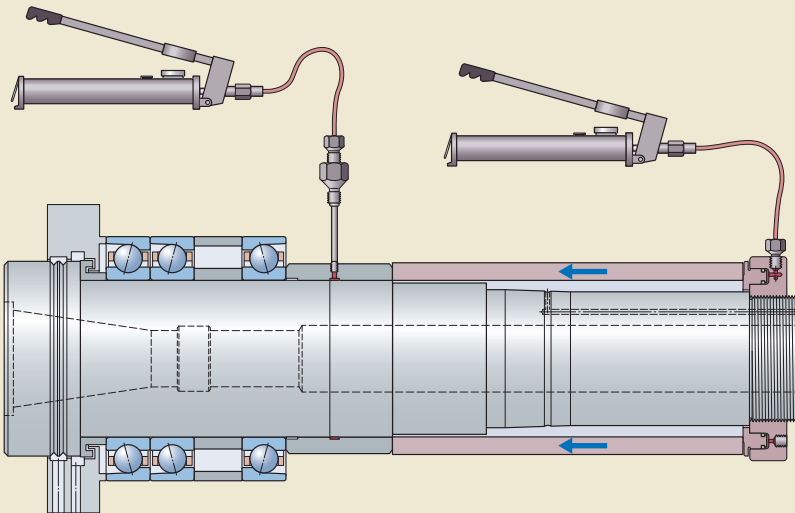

Removal

To remove a stepped sleeve, inject oil or an SKF dismantling fluid between the sleeve and shaft using suitable oil injection equipment (→ *Oil injection equipment and pressure media*). When sufficient oil pressure has been built up to separate the mating surfaces, an axial force will result due to the different bore diameters, and the sleeve will slide from its seat without requiring any additional external force.

WARNING

To avoid the risk of serious injury, attach a provision such as a lock nut to the shaft end to limit the sleeve travel when it suddenly comes loose.

Oil injection equipment and pressure media

SKF supplies oil injection equipment for installing and removing sleeves. For additional information, visit skf.com/mapro.

When selecting a suitable pump, keep in mind that the maximum permissible pressure should be considerably higher than the calculated surface pressure.

For installation, SKF recommends using the SKF mounting fluid LHM 300. The fluid has a viscosity of 300 mm²/s at 20 °C (70 °F). The advantage of this mounting fluid is that when installation is complete, the fluid will leave the joint quickly and completely so that metal-to-metal contact is restored relatively quickly.

For removal, SKF recommends using the SKF dismantling fluid LHDF 900. With a viscosity of 900 mm²/s at 20 °C (70 °F), the fluid will provide an adequate oil film, even if the mating surface of the sleeve or shaft is scratched. Keep in mind that the fluid has a low flow rate and the permissible pressure of the oil injection equipment should never be exceeded.

Provisions for mounting and dismounting

It is often necessary to make provisions during the design stage to facilitate mounting and dismounting of a bearing. If, for example, slots or recesses are machined in the shaft and/or housing shoulders, it is possible to apply withdrawal tools (→ **fig. 31**). Threaded holes in the housing shoulders also enable the use of bolts to push a bearing from its seat (→ **fig. 32**).

If the oil injection method is to be used to mount or dismount bearings on a tapered seat, ducts and grooves should be provided in the shaft (→ **fig. 33**). Recommended dimensions for the appropriate grooves, ducts and threaded holes to connect the oil supply are listed in **tables 19** and **20**.

Fig. 31

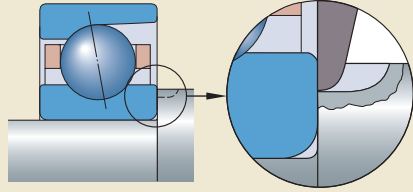

Fig. 32

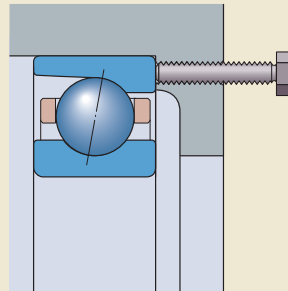

Fig. 33

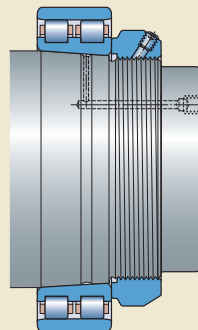
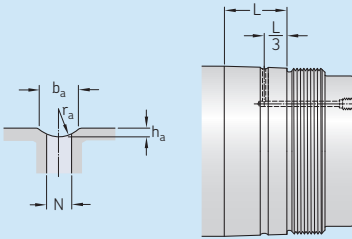

Table 19

Recommended dimensions for oil supply ducts and distribution grooves



Seat diameter		Dimensions			
over	incl.	b _a	h _a	r _a	N
mm		mm			
–	50	2,5	0,5	2	2
50	100	3	0,5	2,5	2,5
100	150	4	0,8	3	3
150	200	4	0,8	3	3
200	250	5	1	4	4
250	300	5	1	4	4
300	400	6	1,25	4,5	5
400	500	7	1,5	5	5
500	650	8	1,5	6	6
650	800	10	2	7	7

L = width of bearing seat

Table 20

Design and recommended dimensions for threaded holes for connecting oil supply

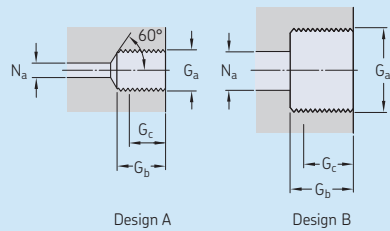

Thread G _a	Design	Dimensions		
		G _b	G _c ¹⁾	N _a max.
–	–	mm		
M 4x0,5	A	5	4	2
M 6	A	10	8	3
G 1/8	A	12	10	3
G 1/4	A	15	12	5
G 3/8	B	15	12	8
G 1/2	B	18	14	8
G 3/4	B	20	16	8

¹⁾ Effective threaded length

Bearing preload

Preload is a force acting between the rolling elements and bearing rings that is not caused by an external load. Preload can be regarded as negative internal clearance. Reasons to apply preload include:

- enhanced stiffness
- reduced noise level
- improved shaft guidance
- extended bearing service life
- improved running accuracy
- prevent skidding in high-speed applications during rapid starts and stops and under very light or no-load conditions

In the majority of high-precision applications, preload is needed to enhance system rigidity.

Angular contact ball bearings

Single row angular contact ball bearings are generally mounted as sets, in a back-to-back (→ **figs. 34** and **35**) or face-to-face arrangement (→ **fig. 36**), that are normally subjected to an axial preload. The preload is produced by displacing one bearing ring axially, relative to the other (→ **figs. 34** and **36**), by an amount corresponding to the desired preload force or by springs (→ **fig. 35**).

The standout of matched and universally matchable bearings is precision ground so that when two bearings are mounted immediately adjacent to each other, a given preload is obtained without further adjustment. Keep in mind that this preload is also influenced by the interference fit and the operating conditions. For additional information, refer to *Preload in mounted bearing sets* (→ **page 162**).

If it is necessary to change the preload, spacers between the bearing rings can be used. For additional information, refer to *Individual adjustment of preload* (→ **page 166**).

Fig. 34

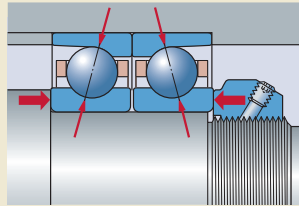

Fig. 35

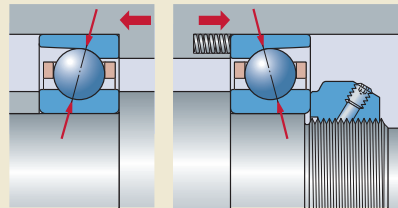
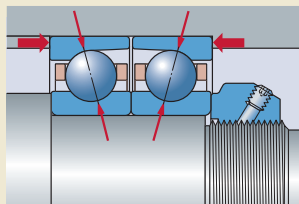

Fig. 36



Influence of an external load on preloaded bearing sets

The influence of an external axial load on preloaded bearing sets is illustrated in **diagram 13**. The curves represent the spring characteristics of two bearings in a back-to-back arrangement. The blue curve represents bearing A, which is subjected to an external axial force K_a . The red curve represents bearing B, which becomes unloaded by the axial force.

The two bearings are each preloaded by an axial displacement δ_0 of one bearing ring relative to the other, resulting in a preload force F_0 acting on both bearings. When bearing A is subjected to an external axial force K_a , the load on that bearing increases to F_{aA} while load on bearing B decreases to F_{aB} . Axial displacement of the bearing rings follows the spring curves. δ_{K_a} is the displacement of the bearing set while δ_{K_b} is the remaining preload [μm] on bearing B.

When the axial forces on the spindle reach the natural lifting force K_{a1} , bearing B becomes completely unloaded. When this happens, there is a significant risk that the unloaded balls stop rolling and start skidding, which if it occurs for any length of time will result in premature bearing failure.

The lifting force varies depending on the preload and bearing arrangement (\rightarrow **table 21, page 92**). It is possible to avoid the lifting force phenomena in one of two ways: either increase the preload, or use bearing sets with different contact angles. For additional information, contact the SKF application engineering service.

Diagram 13

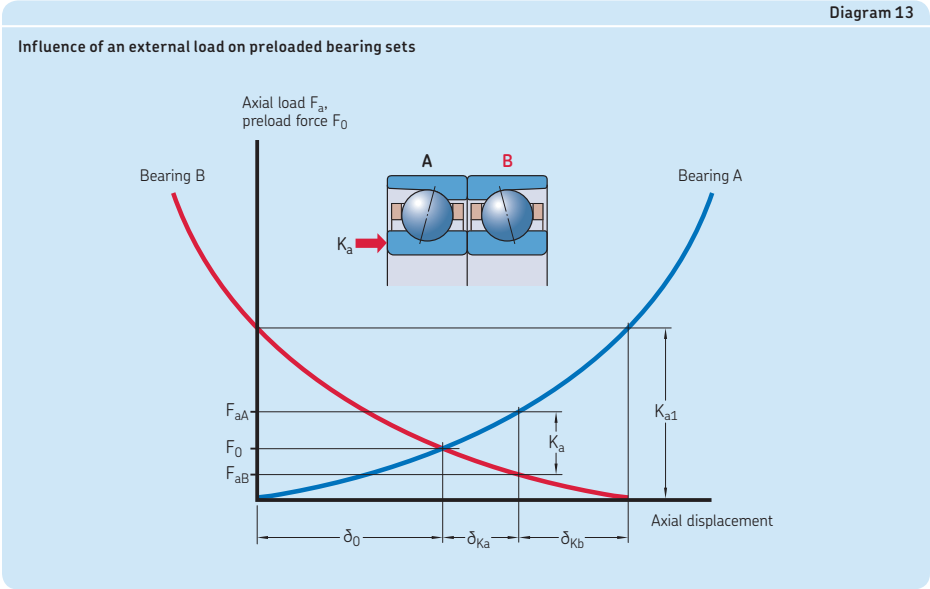

Table 21

Lifting forces for angular contact ball bearing sets

Arrangement

Lifting forces
 K_{a1}

K_{b1}

Same contact angles ($\alpha_A = \alpha_B$)

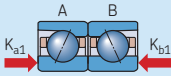

$2,83 F_0$

$2,83 F_0$

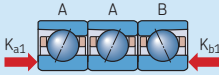

$4,16 F_0$

$2,08 F_0$

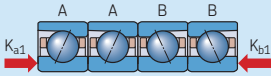

$2,83 F_0$

$2,83 F_0$

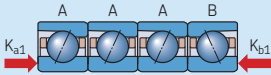

$5,4 F_0$

$1,8 F_0$

Different contact angles ($\alpha_A = 25^\circ, \alpha_B = 15^\circ$)

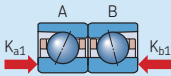

$5,9 F_0$

$1,75 F_0$

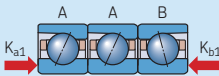

$9,85 F_0$

$1,45 F_0$

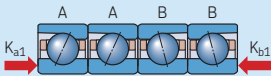

$5,9 F_0$

$1,75 F_0$

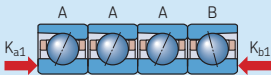

$13,66 F_0$

$1,33 F_0$

F_0 = preload force

Preloading with springs

Using springs to apply preload to angular contact ball bearings is common, especially in high-speed grinding spindles. The springs act on the outer ring of one of the two bearings. This outer ring must be able to be displaced axially. The preload force remains practically constant, even when there is axial displacement of the bearing as a result of thermal shaft expansion. For additional information concerning preloading with springs and values for preload force, refer to *Preload with a constant force* (→ **page 165**).

Preloading with springs is not suitable for applications where a high degree of stiffness is required, where the direction of load changes, or where indeterminate shock loads can occur.

Cylindrical roller bearings

Cylindrical roller bearings can only be preloaded radially (→ **fig. 37**). Bearings with a tapered bore are preloaded by driving the bearing inner ring up onto its tapered seat. The resulting interference fit causes the inner ring to expand and to obtain the necessary preload. To accurately set preload, internal clearance gauges should be used. For additional information, refer to *Mounting* (→ **page 280**) or *Adjusting for clearance or preload* (→ **page 278**).

Angular contact thrust ball bearings

Angular contact thrust ball bearings can only be preloaded axially (→ **fig. 38**). The standout of angular contact thrust ball bearings is precision ground so that when the two halves of the bearing are assembled, a given preload is obtained without further adjustment. Keep in mind that preload is also influenced by the interference fit and the operating conditions.

Under load, angular contact thrust ball bearings exhibit similar characteristics as angular contact ball bearings. Therefore, the information provided for angular contact ball bearings is also valid for these bearings. The lifting force for single direction angular contact thrust ball bearings for screw drives in the BSA and BSD series is the same as for angular contact ball bearings (→ **table 21, page 92**).

For double direction angular contact thrust ball bearings in the BTW and BTM series, the lifting force can be estimated from

$$K_{a1} = 2,85 F_0$$

where

K_{a1} = lifting force

F_0 = preload on bearings before external axial load is applied

Fig. 37

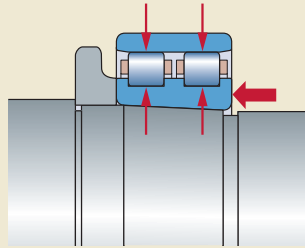
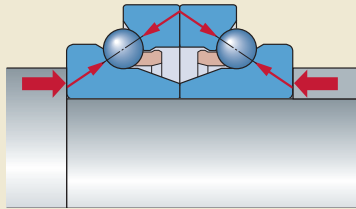

Fig. 38



Sealing solutions

Contaminants and moisture can negatively affect bearing service life and performance. This is particularly important for machine tool applications where coolant and swarf are an integral part of the operating environment. Therefore, an effective sealing arrangement is essential if a spindle is to operate reliably. To protect the bearings, SKF offers a wide assortment of external and integral seals.

External seals

For bearing arrangements where the effectiveness of the seal under specific operating conditions is more important than space considerations or cost, there are two types of external seals available: non-contact seals

(→ fig. 39) and contact seals (→ fig. 41, page 98).

For seals that are not supplied by SKF, the information provided in the following section should be used as a guideline only. Make sure to understand the seal's performance criteria before incorporating that seal into an application. SKF does not accept liability for the performance of any products not supplied by SKF.

1

Fig. 39

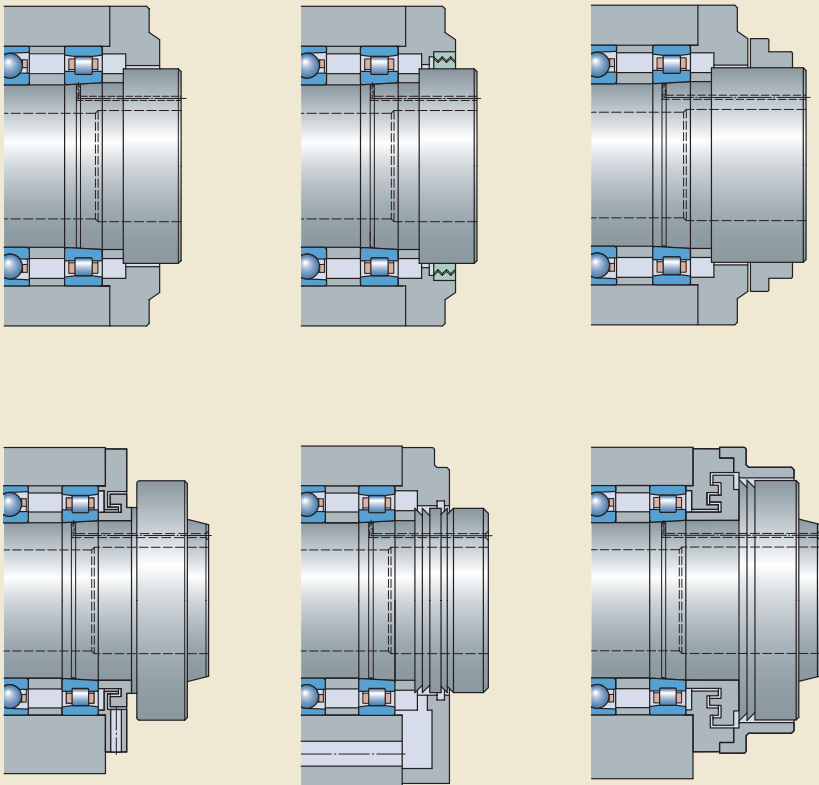

Non-contact seals

Non-contact seals are almost always used in high-speed precision applications. Their effectiveness depends, in principle, on the sealing action of the narrow gap between the shaft and housing. Because there is no contact, these seals generate almost no friction and do not, in practice, limit speeds, making them an excellent solution for machine tool applications.

Seal variants range from simple gap-type seals to multi-stage labyrinth seals (→ **fig. 39, page 95**). Compared to gap-type seals, multi-stage labyrinth seals are considerably more effective as their series of axially and radially intersecting components make it more difficult for contaminants and cutting fluid to enter the bearing.

In highly contaminated environments, a complex labyrinth seal design is often required. Labyrinth seals can have three or more stages to keep lubricant in and contaminants out of the bearing arrangement. The principle of a highly effective labyrinth seal, outlined in **fig. 40**, consists of three stages:

- the primary stage
- the secondary stage
- the final stage

This design, with drainage chambers and collecting provisions, is derived from studies done by the Technical University of Stuttgart, Germany.

The primary stage consists of a splash guard (**1**), a housing cover (**2**) and the shaft to form a labyrinth. The splash guard uses centrifugal force to direct contaminants away from the cover, while the housing cover prevents contaminants from entering the labyrinth directly. A radial gap (**3**) between the housing cover and the shaft should be between 0,1 and 0,2 mm.

The secondary stage is designed to collect any fluid that manages to pass the primary barrier and drain it away. Starting with annular groove(s) in the shaft (**4**), the main design features of this stage include a large drainage chamber (**5**) and an outlet hole (**6**). Annular groove(s) deter fluid from travelling along the shaft under non-rotating conditions, causing it to drip into the drainage chamber instead. When the shaft is rotating, fluid is flung from it and collected in the drainage chamber and drained through the outlet hole. Large drain-

age holes (~ 250 mm²) in the collection area limit the amount of fluid that collects in the chamber.

Features used in the previous stages are incorporated again in the final stage. This section consists of labyrinth rings (**7**) with radial gaps between 0,2 and 0,3 mm, a fluid retardation chamber (**8**), a collector (**9**) to guide the fluid toward the drainage area and an outlet hole (**10**) with a drainage area of ~ 150 mm². An additional chamber, collector and a ~ 50 mm² drainage hole (**11**) can be incorporated if space permits. A final radial labyrinth gap (**12**) of ~ 1 mm avoids capillary action.

When designing these types of sealing arrangements, the following should be taken into consideration:

- In order to avoid inward pumping effects, the labyrinth components should progressively decrease in diameter from the outside.
- Machine lead on rotating components can move fluids in either axial direction very effectively depending on the hand of the lead and the direction of rotation. This can, in uni-directional applications, be exploited to reinforce the effectiveness of gap or labyrinth seals if carefully incorporated into the design. Machine lead on rotating components of gap and labyrinth seals should be avoided when the application rotates in both directions or for uni-directional applications where its action would work against the effectiveness of the seal.
- Under severe operating conditions, an air barrier can be created by applying air, under pressure, between the labyrinth gaps or inside the spindle itself. The air flow must however be balanced so that the dominant flow is always outward.
- A sealing system that takes up considerable axial space is favourable, as this enables large drainage areas and collectors to be incorporated into the system. In these cases, however, the spindle is less rigid as a result of the long overhang from the front bearings (and cutting force position).

Fig. 40

1

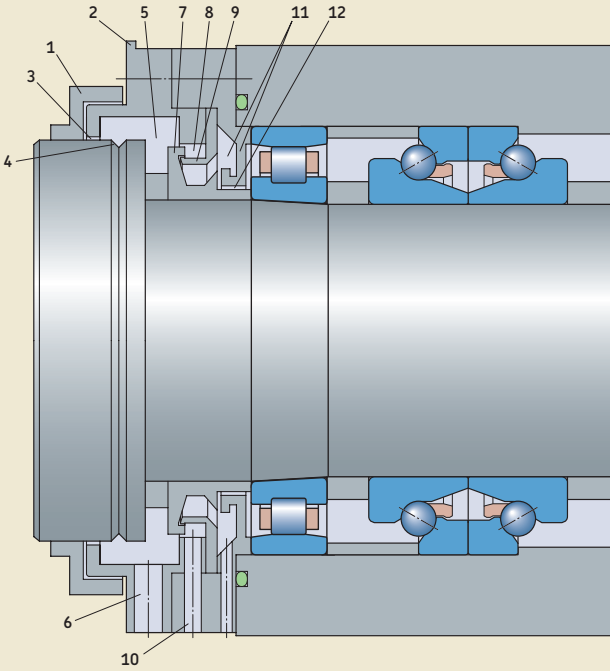

Contact seals

Contact seals (→ **fig. 41**) are generally very reliable. Their effectiveness, however, depends on a number of factors including:

- the seal design
- the seal material
- the contact pressure
- the surface finish of the seal counterface
- the condition of the seal lip
- the presence of lubricant between the seal lip and counterface

Friction between the seal lip and counterface can generate a significant amount of heat at higher speeds ($A \geq 200\,000$ mm/min). As a result, these seals can only be used in lower speed spindles and/or in applications where the additional heat does not significantly affect spindle performance.

Integral seals

Sealed bearings are generally used for arrangements where a sufficiently effective external sealing solution cannot be provided for cost reasons or because of space limitations.

SKF supplies a wide assortment of super-precision bearings fitted with a seal on each side. For details, refer to *Sealing solutions* in the relevant product chapter.

Fig. 41

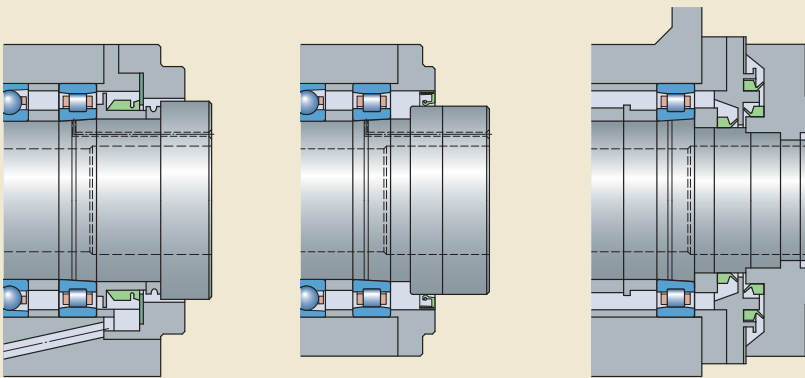

Lubrication

Selecting a suitable lubricant and lubrication method for a super-precision bearing arrangement depends primarily on the operating conditions such as the required speed or permissible operating temperature. However, other factors like vibration, loads and the lubrication of adjacent components, such as gears, can also influence the selection process.

To generate an adequate hydrodynamic film between the rolling elements and raceways, only a very small amount of lubricant is required. Therefore, using grease as a lubricant for spindle bearing arrangements is becoming increasingly popular. With a properly designed grease lubrication system, the hydrodynamic frictional losses are low and operating temperatures can be kept to a minimum. However, where speeds are very high, grease service life may be too short and oil lubrication may be required. Typically, oil lubrication is accomplished with an oil-air system or an oil circulation system which can also provide the added benefit of cooling.

Grease lubrication

Grease lubricated bearing arrangements are suitable for a wide range of speeds. Lubricating super-precision bearings with suitable quantities of good quality grease permits relatively high speed operation without an excessive rise in temperature.

The use of grease also means that the design of a bearing arrangement can be relatively simple because grease is more easily retained in a bearing arrangement than oil, particularly where shafts are inclined or vertical. Grease can also contribute to sealing the arrangement against solid and liquid contaminants as well as moisture.

Selecting grease

In most spindle applications with super-precision bearings, grease with a mineral base oil and lithium thickener is suitable. These greases adhere well to the bearing surfaces and can be used in applications where temperatures range from -30 to $+110$ °C (-20 to $+230$ °F). For applications with high speeds and high temperatures or where long service life is required, grease with a synthetic base oil e.g.

SKF diester oil based grease LGLT 2 has been proven to be effective.

For angular contact thrust ball bearings for screw drives, grease with an ester or mineral base oil and calcium complex thickener can be used under most operating conditions.

Alternative greases may be required under any of the following conditions:

- operating temperatures < 10 °C (50 °F) or > 100 °C (210 °F)
- bearing speed is very high or very low
- static operation, infrequent rotation or oscillation
- bearings are subjected to vibration
- bearings are subjected to heavy loads or shock loads
- water resistance is important
- screw drive bearings at low speeds, under heavy loads or exposed to vibration should be lubricated with a lithium soap grease with a mineral base oil and EP additives like SKF LGEP 2

An appropriate grease selection process comprises four steps.

1. Select the consistency grade

Greases are divided into various consistency grades in accordance with the National Lubricating Grease Institute (NLGI). Greases with a high consistency, i.e. stiff greases, are assigned high NLGI grades, while those with low consistency, i.e. soft greases, are assigned low NLGI grades. In rolling bearing applications, three consistency grades are recommended:

- The most common greases, used in normal bearing applications, have an NLGI grade of 2.
- Low consistency rolling bearing greases, classified as NLGI 1 greases, are preferred for low ambient temperatures and oscillating applications.
- NLGI 3 greases are recommended for large bearings, vertical shaft arrangements, high ambient temperatures or the presence of vibration.

2. Determine the required base oil viscosity

For detailed information about calculating the required base oil viscosity, refer to *Lubrication conditions - the viscosity ratio κ* in the SKF cata-

logue *Rolling bearings* or at skf.com. The graphs in this catalogue are based on the elasto-hydrodynamic theory of lubrication (EHL) with full-film conditions.

It has been found, however, that when using greases containing very low or very high viscosity base oils, a thinner oil film than that predicted by EHL theories results. Therefore, when using the graphs to determine the required base oil viscosity for grease lubricated super-precision bearings, corrections may be necessary. From practical experience, determine the required viscosity ν at reference temperature 40 °C (150 °F) and then adjust as follows:

- $\nu \leq 20 \text{ mm}^2/\text{s}$ → multiply the viscosity by a factor of 1 to 2
In this low range, the viscosity of the oil is too thin to form a sufficiently thick oil film.
- $20 \text{ mm}^2/\text{s} < \nu \leq 250 \text{ mm}^2/\text{s}$ → no correction factor is used
- $\nu > 250 \text{ mm}^2/\text{s}$ → contact the SKF application engineering service

Calculations can also be made using the SKF program, Viscosity, available online at skf.com/bearingcalculator.

High viscosity greases increase friction and heat generated by the bearing but may be necessary, for example, for ball screw support bearings in low-speed applications or in applications where there is a risk of false brinelling.

3. Verify the presence of EP additives

Grease with EP additives may be appropriate if super-precision bearings are subjected to any of the following conditions:

- very heavy loads ($P > 0,15 \text{ C}$)
- shock loads
- low speeds
- periods of static loading
- frequent starts and stops during a work cycle

Lubricants with EP additives should only be used when necessary and always within their operating temperature range. Some EP additives are not compatible with bearing materials particularly at higher temperatures. For additional information, contact the SKF application engineering service.

4. Check additional requirements

In some applications, operating conditions may put additional requirements on the grease, requiring it to have unique characteristics. The following recommendations are provided as guidelines:

- For superior resistance to water wash-out, consider grease with a calcium thickener over a lithium thickener.
- For good rust protection, select an appropriate additive.
- If there are high vibration levels, choose grease with a high mechanical stability.

To select the appropriate grease for a specific bearing type and application, the grease selection program, SKF LubeSelect, available online at skf.com/lubrication, can be used.

Initial grease fill

Super-precision bearings operating at high speeds should have less than 30% of the free space in the bearings filled with grease.

Open angular contact thrust ball bearings for screw drives should be lubricated with a grease quantity that fills ~ 25 to 35% of the free space in the bearing.

Freshly greased bearings should be operated at low speeds during the running-in period (→ *Running-in of grease lubricated bearings*, **page 111**). This enables excess grease to be displaced and the remainder to be evenly distributed within the bearing. If this running-in phase is neglected, there is a risk that temperature peaks can lead to premature bearing failure.

The initial grease fill depends on the bearing type, series and size as well as the speed factor A.

$$A = n d_m$$

where

A = speed factor [mm/min]

d_m = bearing mean diameter [mm]

$$= 0,5 (d + D)$$

n = rotational speed [r/min]

The initial grease fill for open bearings can be estimated using

$$G = K G_{ref}$$

where

G = initial grease fill [cm³]

G_{ref} = reference grease quantity [cm³]

– for angular contact ball bearings

→ **table 22, page 102**

– for cylindrical roller bearings

→ **table 23, page 103**

– for double direction angular contact thrust ball bearings → **table 24,**

page 104

– for single direction angular contact thrust ball bearings for screw drives

→ **table 25, page 104**

K = a calculation factor dependent on the bearing type and the speed factor A (→ **diagram 14, page 105**)

Sealed bearings are filled with a high grade, low viscosity grease that fills ~ 15% of the free space in the bearing. They are considered to be relubrication-free under normal operating conditions. The grease is characterized by:

- high-speed capability
- excellent resistance to ageing
- very good rust inhibiting properties

The technical specifications of the grease are listed in **table 26, page 104**.

Table 22

Reference grease quantity for angular contact ball bearings

Bore diameter d	Size	Reference grease quantity G_{ref} for bearings in the series							
		718 CD 718 ACD	719 CD 719 ACD	719 CE 719 ACE	719 CB 719 ACB	70 CD 70 ACD	70 CE 70 ACE	70 CB 70 ACB	72 CD 72 ACD
mm	–	cm ³							
6	6	–	–	–	–	0,09	0,09	–	–
7	7	–	–	–	–	0,12	0,11	–	0,16
8	8	–	–	0,09	–	0,15	0,17	–	0,23
9	9	–	–	0,09	–	0,18	0,19	–	0,26
10	00	0,06	0,12	0,1	–	0,24	0,28	–	0,36
12	01	0,07	0,12	0,1	–	0,27	0,31	–	0,51
15	02	0,08	0,21	0,2	–	0,39	0,5	–	0,73
17	03	0,09	0,24	0,2	–	0,54	0,68	–	1
20	04	0,18	0,45	0,5	–	0,9	1,1	–	1,5
25	05	0,21	0,54	0,6	–	1	1,3	–	1,9
30	06	0,24	0,63	0,6	0,72	1,6	1,7	1,4	2,8
35	07	0,28	0,93	0,8	0,96	2	2,4	1,8	3,9
40	08	0,31	1,4	1,4	1,4	2,4	2,8	2,2	4,7
45	09	0,36	1,6	1,5	1,8	3,3	3,4	2,9	5,9
50	10	0,5	1,7	1,7	1,9	3,6	4,1	3,1	6,7
55	11	0,88	2,5	2,3	2,6	5,1	5	4,7	8,6
60	12	1,2	2,7	2,5	2,8	5,4	5,3	5	10
65	13	1,3	2,9	2,6	3	5,7	6,2	5,5	12
70	14	1,4	4,5	4,3	4,5	8,1	8,2	7,3	14
75	15	1,5	5,1	4,5	4,8	8,4	8,6	7,7	15
80	16	1,6	5,1	4,8	5,3	11	12	10	18
85	17	2,7	7,2	7	6,5	12	12	11	22
90	18	2,9	7,5	7	7,4	15	14	14	28
95	19	3,1	7,8	7,3	7,5	16	17	15	34
100	20	3,2	11	10	10	16	17	15	41
105	21	4	11	–	–	20	–	–	48
110	22	5,1	11	11	11	26	23	22	54
120	24	5,5	15	15	14	27	28	24	69
130	26	9,3	20	–	–	42	–	–	72
140	28	9,9	22	–	–	45	–	–	84
150	30	13	33	–	–	54	–	–	–
160	32	14	33	–	–	66	–	–	–
170	34	–	36	–	–	84	–	–	–
180	36	–	54	–	–	111	–	–	–
190	38	–	57	–	–	114	–	–	–
200	40	–	81	–	–	153	–	–	–
220	44	–	84	–	–	201	–	–	–
240	48	–	93	–	–	216	–	–	–
260	52	–	150	–	–	324	–	–	–
280	56	–	159	–	–	–	–	–	–
300	60	–	265	–	–	–	–	–	–
320	64	–	282	–	–	–	–	–	–
340	68	–	294	–	–	–	–	–	–
360	72	–	313	–	–	–	–	–	–

Values refer to 30% filling grade.

Table 23

1

Reference grease quantity for cylindrical roller bearings

Bore diameter d	Size	Reference grease quantity G_{ref} for bearings in the series				
		N 10 TN	N 10 TNHA	N 10 PHA	NN 30 ¹⁾	NNU 49 ¹⁾
mm	–	cm ³				
25	05	–	–	–	0,9	–
30	06	–	–	–	1	–
35	07	–	–	–	1,9	–
40	08	2,3	2,5	3,1	1,8	–
45	09	2,9	3,2	4,1	2,4	–
50	10	3,2	3,5	4,4	2,7	–
55	11	4,4	4,9	6,1	3,6	–
60	12	4,7	5,2	6,5	3,8	–
65	13	5	5,5	6,9	4,1	–
70	14	6,7	7,2	9,2	5,9	–
75	15	7,1	7,7	9,6	6,3	–
80	16	9	9,8	13	8,3	–
85	17	9,2	10	–	8,4	–
90	18	12	14	–	11	–
95	19	13	14	–	12	–
100	20	13	14	–	12	13
105	21	18	18	–	17	15
110	22	21	21	–	20	17
120	24	22	34	–	23	27
130	26	–	–	–	34	31
140	28	–	–	–	52	45
150	30	–	–	–	63	57
160	32	–	–	–	78	63
170	34	–	–	–	105	72
180	36	–	–	–	138	81
190	38	–	–	–	144	85
200	40	–	–	–	191	117
220	44	–	–	–	260	150
240	48	–	–	–	288	171
260	52	–	–	–	392	366
280	56	–	–	–	420	384

Values refer to 30% filling grade.

¹⁾ For bearings in the NN 30 and NNU 49 series with $d > 280$ mm, contact the SKF application engineering service.

Table 24

Reference grease quantity for double direction angular contact thrust ball bearings

Bore diameter d	Size	Reference grease quantity G_{ref} for bearings in the series	
		BTW	BTM
mm	–	cm ³	
35	07	1,9	–
40	08	2,5	–
45	09	3,1	–
50	10	3,3	–
55	11	4,8	–
60	12	5,2	7,8
65	13	5,6	8,4
70	14	7,4	11
75	15	7,8	11,8
80	16	11	16
85	17	11	16,8
90	18	14	22
95	19	15	22
100	20	16	22
105	21	–	–
110	22	27	38
120	24	28	40
130	26	40	58
140	28	45	62
150	30	56	80
160	32	67	94
170	34	90	126
180	36	117	160
190	38	122	–
200	40	157	–

Values refer to 30% filling grade.

Table 25

Reference grease quantity for single direction angular contact thrust ball bearings for screw drives

Designation	Reference grease quantity G_{ref}
–	cm ³
BSA 201 C	0,4
BSA 202 C	0,5
BSA 203 C	0,7
BSA 204 C	1,2
BSA 205 C	1,5
BSA 206 C	2,2
BSA 207 C	3
BSA 208 C	3,7
BSA 209 C	4,5
BSA 210 C	5,2
BSA 212 C	8,5
BSA 215 C	11,1
BSA 305 C	2,4
BSA 306 C	2,1
BSA 307 C	4,2
BSA 308 C	6,4
BSD 2047 C	1,4
BSD 2562 C	2
BSD 3062 C	2
BSD 3572 C	2,5
BSD 4072 C	2,5
BSD 4090 C	5,2
BSD 45100 C	5,9
BSD 4575 C	2,7
BSD 50100 C	6,5
BSD 55100 C	6,5
BSD 55120 C	7,5
BSD 60120 C	7,5

Values refer to 35% filling grade.

Table 26

Technical specifications of the grease in sealed bearings

Properties	Grease specification
Thickener	Special lithium soap
Base oil type	Ester/PAO
NLGI consistency class	2
Temperature range [°C] [°F]	–40 to +120 –40 to +250
Kinematic viscosity [mm ² /s] at 40 °C (105 °F) at 100 °C (210 °F)	25 6

Factor K for initial grease fill estimation

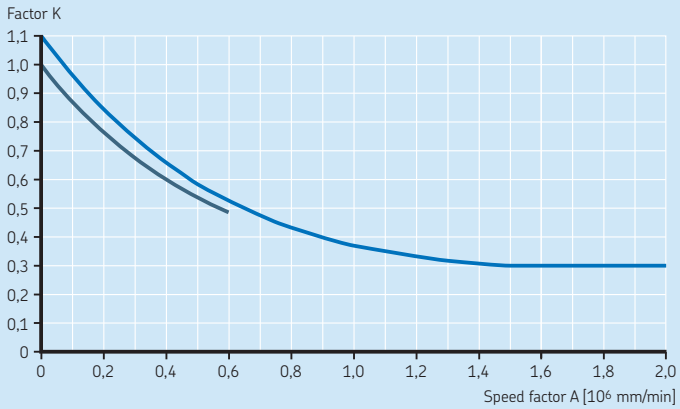

- Angular contact ball bearings, cylindrical roller bearings, double direction angular contact thrust ball bearings
- Angular contact thrust ball bearings for screw drives

Speed factor limits depend on the bearing type and series.

Applying grease

When greasing bearings, the grease should be distributed evenly in the free space between the rolling elements and bearing rings. The bearings should be turned by hand until all internal surfaces are covered.

Small angular contact thrust ball bearings for screw drives often require very small quantities of grease. When a very small grease quantity has to be applied, the bearing should be immersed in a grease solution (3 to 5% grease in a solvent) first. After the solvent has drained and evaporated, grease can be applied. Immersing the bearing in a grease solution ensures that all surfaces are covered with a thin layer of the lubricant.

Grease service life and relubrication intervals

There are several interactive factors influencing grease service life, the effects of which are extremely complex to calculate for any particular application. It is, therefore, standard practice to use estimated grease service life based on empirical data.

The estimated relubrication interval for grease lubricated bearings is based on the estimated grease service life. Various methods can be used, however, SKF recommends the following to assist in making the best estimate for super-precision bearings.

Diagram 15 shows the relubrication interval t_f for super-precision bearings in various executions. The diagram is valid under the following conditions:

- bearing with steel rolling elements
- horizontal shaft
- operating temperature $\leq 70\text{ °C}$ (160 °F)
- high-quality grease with a lithium thickener
- relubrication interval at the end of which 90% of the bearings are still reliably lubricated (L_{10} life)

If necessary, the relubrication interval obtained from **diagram 15** should be adjusted by correction factors depending on the bearing type, variant and operating conditions.

The relubrication interval can be estimated using

$$T_{\text{relub}} = t_f C_1 C_2 \dots C_8$$

The curves for angular contact ball and thrust ball bearings are for single bearings only.

Values for matched sets should be adjusted according to the arrangement, number of bearings in the set and preload, by multiplying the relubrication interval by factor C_1 (\rightarrow **table 27, page 108**). When sets comprising more than four bearings are used, contact the SKF application engineering service.

For hybrid bearings, the estimated grease service life can be revised by multiplying the calculated value for a bearing with steel rolling elements by the correction factor C_2 (\rightarrow **table 28, page 108**).

Depending on the operating conditions, the relubrication interval should be multiplied by each of the relevant correction factors from C_3 to C_8 (\rightarrow **table 29, page 109**).

Other conditions, not included here, such as the presence of water, cutting fluids and vibration may also affect grease service life.

Machine tool spindles often operate under conditions of varying speed, load and operating temperature. If the speed/load spectrum is known and is sufficiently cyclic, the relubrication interval for each speed/load interval can be estimated as above. A relubrication interval for the total duty cycle can then be calculated from

$$t_{f\text{tot}} = \frac{100}{\sum (a_i/t_{fi})}$$

where

$t_{f\text{tot}}$ = total relubrication interval [hours]

a_i = part of the total cycle time at speed n_i [%]

t_{fi} = relubrication interval at speed n_i [hours]

Diagram 15

1

Grease relubrication interval guidelines

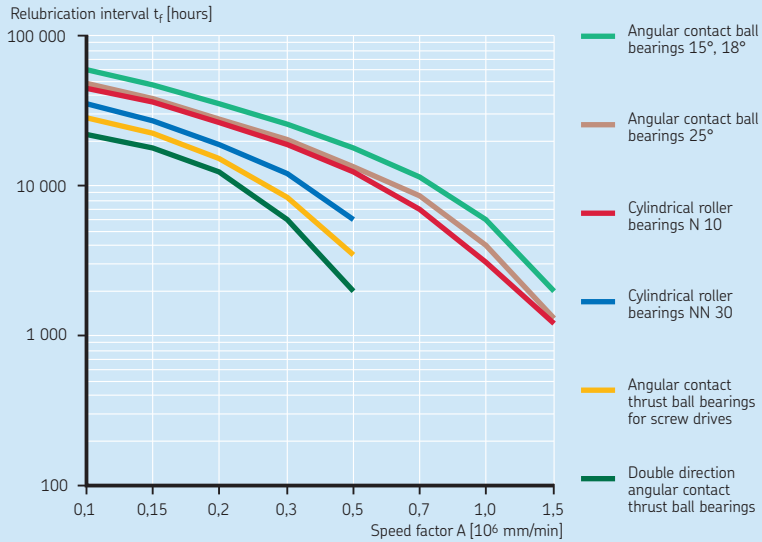

Table 27

Correction factor for bearing sets and different preload classes

Bearing type Bearing series	Arrangement	Design. suffix	Correction factor C_1 Preload class						
			A	L	B	M	C	F	D
Angular contact ball bearings									
719 D, 70 D, 72 D	Set of 2, back-to-back	DB	0,81	–	0,75	–	0,65	–	0,4
	Set of 2, face-to-face	DF	0,77	–	0,72	–	0,61	–	0,36
	Set of 3, back-to-back and tandem	TBT	0,7	–	0,63	–	0,49	–	0,25
	Set of 3, face-to-face and tandem	TFT	0,63	–	0,56	–	0,42	–	0,17
	Set of 4, tandem back-to-back	QBC	0,64	–	0,6	–	0,53	–	0,32
	Set of 4, tandem face-to-face	QFC	0,62	–	0,58	–	0,48	–	0,27
718 D, 719 E, 70 E	Set of 2, back-to-back	DB	0,8	–	0,65	–	0,4	–	–
	Set of 2, face-to-face	DF	0,77	–	0,61	–	0,36	–	–
	Set of 3, back-to-back and tandem	TBT	0,69	0,72	0,49	0,58	0,25	0,36	–
	Set of 3, face-to-face and tandem	TFT	0,63	0,66	0,42	0,49	0,17	0,24	–
	Set of 4, tandem back-to-back	QBC	0,64	–	0,53	–	0,32	–	–
	Set of 4, tandem face-to-face	QFC	0,62	–	0,48	–	0,27	–	–
719 B, 70 B	Set of 2, back-to-back	DB	0,83	–	0,78	–	0,58	–	–
	Set of 2, face-to-face	DF	0,8	–	0,74	–	0,54	–	–
	Set of 3, back-to-back and tandem	TBT	0,72	–	0,66	–	0,4	–	–
	Set of 3, face-to-face and tandem	TFT	0,64	–	0,56	–	0,3	–	–
	Set of 4, tandem back-to-back	QBC	0,67	–	0,64	–	0,48	–	–
	Set of 4, tandem face-to-face	QFC	0,64	–	0,6	–	0,41	–	–
Double direction angular contact thrust ball bearings									
BTW	–	–	1	–	–	–	–	–	–
BTM	–	–	1	–	0,5	–	–	–	–
Angular contact thrust ball bearings for screw drives									
BSA, BSD	Set of 2	–	0,8	–	0,4	–	–	–	–
	Set of 3	–	0,65	–	0,3	–	–	–	–
	Set of 4	–	0,5	–	0,25	–	–	–	–

Table 28

Correction factor for hybrid bearings

Bearing type	Correction factor C_2 Speed factor A [10^6 mm/min]			
	0,5	0,7	1	1,5
Angular contact ball bearings	3	3,5	3	2,8
Double direction angular contact thrust ball bearings	3	–	–	–
Cylindrical roller bearings	3	3	3	2,5

Table 29

Correction factors for operating conditions		
Operating condition	Correction factor	
Shaft orientation		
Vertical	C ₃	0,5
Horizontal		1
Bearing load		
P < 0,05 C	C ₄	1
P < 0,1 C		0,7
P < 0,125 C		0,5
P < 0,2 C		0,3
P < 0,5 C		0,2
P < C		0,1
Reliability		
L ₁	C ₅	0,37
L ₁₀		1
L ₅₀		2
Air flow through the bearing		
Low	C ₆	1
Moderate		0,3
Strong		0,1
Moisture and dust		
Low	C ₇	1
Moderate		0,5
High		0,3
Very high		0,1
Operating temperature		
40 °C (105 °F)	C ₈	2
55 °C (130 °F)		2
70 °C (125 °F)		1
85 °C (185 °F)		0,5
100 °C (210 °F)		0,25

Miscibility

When an alternative grease is being considered for an existing application, check the compatibility of the new grease with the current grease relative to the base oil (→ **table 30**) and thickener (→ **table 31, page 110**). These tables are based on grease composition and should only be used as guidelines. SKF recommends verifying miscibility with a grease expert and then testing the new grease in the application.

Before applying a new grease type, remove as much of the old grease as possible from the bearing arrangement. If the new grease is incompatible with the existing grease, or if the old grease contains a PTFE thickener or is silicone based, the bearings should be washed thoroughly using an appropriate solvent. Once the new grease is applied, monitor the bearings carefully to be sure that the new grease functions properly.

Table 30

Compatibility of base oil types						
	Mineral oil	Ester oil	Polyglycol	Silicone-methyl	Silicone-phenyl	Polyphenylether
Mineral oil	+	+	-	-	+	o
Ester oil	+	+	+	-	+	o
Polyglycol	-	+	+	-	-	-
Silicone-methyl	-	-	-	+	+	-
Silicone-phenyl	+	+	-	+	+	+
Polyphenylether	o	o	-	-	+	+

+ compatible
 - incompatible
 o individual testing required

Table 31

Compatibility of thickener types

	Lithium soap	Calcium soap	Sodium soap	Lithium complex soap	Calcium complex soap	Sodium complex soap	Barium complex soap	Aluminium complex soap	Clay	Polyurea
Lithium soap	+	o	-	+	-	o	o	-	o	o
Calcium soap	o	+	o	+	-	o	o	-	o	o
Sodium soap	-	o	+	o	o	+	+	-	o	o
Lithium complex soap	+	+	o	+	+	o	o	+	-	-
Calcium complex soap	-	-	o	+	+	o	-	o	o	+
Sodium complex soap	o	o	+	o	o	+	+	-	-	o
Barium complex soap	o	o	+	o	-	+	+	+	o	o
Aluminium complex soap	-	-	-	+	o	-	+	+	-	o
Clay	o	o	o	-	o	-	o	-	+	o
Polyurea	o	o	o	-	+	o	o	o	o	+

+ compatible
 - incompatible
 o individual testing required

Running-in of grease lubricated bearings

Grease lubricated super-precision bearings initially run with a relatively high frictional moment. If they are run at high speeds without a running-in period, the temperature rise can be considerable. The high frictional moment is due to the churning of excess grease, which takes time to work its way out of the contact zone. For open bearings, this time period can be minimized by applying the required quantity of grease distributed evenly on both sides of the bearing during assembly. Spacers between adjacent bearings can also reduce the running-in period.

The time required to stabilize the operating temperature depends on the following factors:

- the type of grease
- the initial grease fill
- how the grease is applied to the bearings
- the number and arrangement of bearings in a set
- the available space for excess grease to accumulate on either side of the bearing
- the running-in procedure

Super-precision bearings can typically operate with a minimum quantity of lubricant when properly run-in, enabling the lowest frictional moment and operating temperature to be achieved. Grease that collects on each side of the bearing acts as a reservoir, enabling oil to bleed into the raceway to provide effective lubrication for a long time.

Running-in can be done in several ways. Wherever possible and regardless of the procedure chosen, running-in should involve operating the bearing in both a clockwise and counter-clockwise direction.

Standard running-in procedure

The most common running-in procedure can be summarized as follows:

- 1 Select a low start-up speed and a relatively small speed increment.
- 2 Decide on an absolute temperature limit, usually 60 to 65 °C (140 to 150 °F). SKF recommends setting the machine with limit switches that stop the spindle if the temperature rise exceeds the set limit.
- 3 Start operation at the selected start-up speed.
- 4 Monitor the temperature rise by taking measurements at the bearing outer ring position, and wait for the temperature to stabilize. If the temperature reaches the limit, stop the spindle and allow the bearing to cool. Repeat the process at the same speed and run the spindle until the temperature stabilizes below the limit.
- 5 Once the bearing temperature has stabilized, continue to run the spindle for an additional 10 to 15 minutes. Then, increase the speed by one increment and repeat step 4.
- 6 Continue increasing the speed incrementally, allowing the temperature to stabilize at each stage, until the spindle reaches one speed interval above the operating speed of the system. This results in a lower temperature rise during normal operation. The bearing is now properly run-in.

This standard running-in procedure is time-consuming. For a medium- to high-speed spindle, each stage can take anywhere from 30 minutes to 2 hours before the temperature stabilizes. The total time for the running-in procedure can be 8 to 10 hours (→ **diagram 16, page 112**).

Graphic representation of a running-in procedure

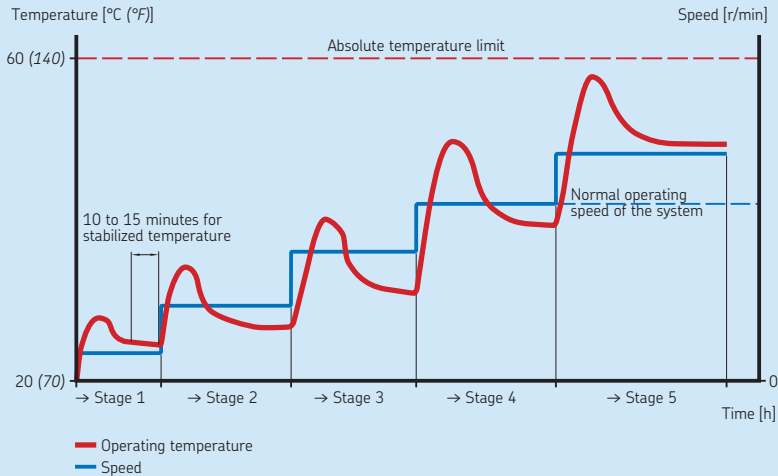

Short running-in procedure

An alternative to the standard running-in procedure reduces the number of stages and shortens the overall running-in time. The main steps can be summarized as follows:

- 1 Select a start-up speed approximately 20 to 25% of the attainable speed for grease lubrication (→ **product tables**) and choose a relatively large speed increment.
- 2 Decide on an absolute temperature limit, usually 60 to 65 °C (140 to 150 °F). It is advisable to set the machine with limit switches that stop the spindle if the temperature rise exceeds the limits set.
- 3 Start operation at the chosen start-up speed.
- 4 Monitor the temperature by taking measurements at the bearing outer ring position until the temperature reaches the limit. Care should be taken as the temperature increase may be very rapid.
- 5 Stop operation and let the outer ring of the bearing cool down by 5 to 10 °C (10 to 20 °F).
- 6 Start operation at the same speed a second time and monitor the temperature until the limit is reached again.

- 7 Repeat steps 5 and 6 until the temperature stabilizes for 10 to 15 minutes below the limit. The bearing is run-in at that particular speed.
- 8 Increase the speed by one increment and repeat steps 4 to 7.
- 9 Proceed until the bearing is running at one speed increment above the operating speed of the system. This results in a lower temperature rise during normal operation. The bearing is now properly run-in.

Although each stage may have to be repeated several times, each cycle is just a few minutes long. The total time for this running-in procedure is substantially less than for the standard procedure.

Oil lubrication

Oil lubrication is recommended for many applications, as different supply methods can be adapted to suit different operating conditions and the machine's design. When selecting the most appropriate oil lubrication method for a bearing arrangement, the following application requirements should be considered:

- required quantity and viscosity of the oil
- speed and hydrodynamic frictional losses
- permissible bearing temperature

The typical relationship between oil quantity / oil flow rate, frictional losses and bearing temperature is shown in **diagram 17**. The diagram illustrates the conditions in different regions:

- **Region A**
The oil quantity is insufficient to create a hydrodynamic film between the rolling elements and raceways. Metal-to-metal contact leads to increased friction, high bearing temperatures, wear and surface fatigue.
- **Region B**
A larger quantity of oil is available and a cohesive, load-carrying oil film of sufficient thickness to separate the rolling elements and raceways can be formed. Here, the con-

dition is reached where friction and temperature are at a minimum.

- **Region C**
A further increase in oil quantity increases frictional heat due to churning and bearing temperature rises.
- **Region D**
The oil flow quantity increases such that equilibrium between frictional heat generation at the bearing and heat removal by the oil flow is achieved. Bearing temperature peaks.
- **Region E**
With increasing oil flow, the rate at which heat is removed exceeds the frictional heat generated by the bearing. Bearing temperature decreases.

Maintaining low operating temperatures at extremely high speeds generally requires either an oil-air lubrication system or a circulating oil lubrication system with cooling capabilities. With these systems, the operating conditions shown in regions B (oil-air) or E (circulating oil) can be maintained.

Diagram 17

Bearing temperature and frictional losses as a function of oil quantity

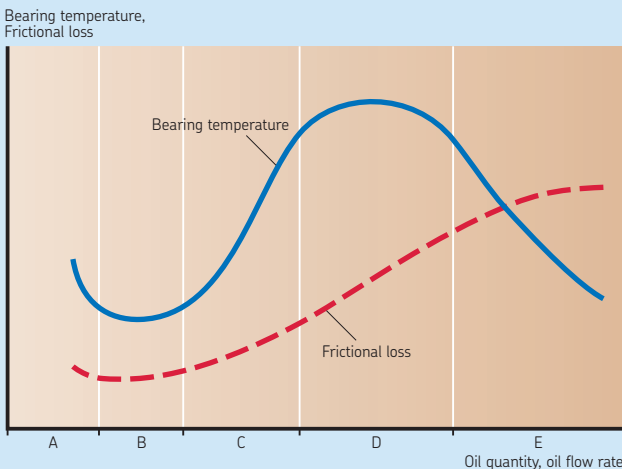

Oil lubrication methods

Oil bath

The simplest method of oil lubrication is the oil bath. The oil, which is picked up by the rotating components of the bearing, is distributed within the bearing and then flows back to a sump in the housing. Typically, the oil level should almost reach the centre of the lowest rolling element when the bearing is stationary. Oil bath lubrication is particularly suitable for low speeds. At high speeds, however, too much oil is supplied to the bearings, increasing friction and causing the operating temperature to rise.

Circulating oil

In general, high-speed operation increases frictional heat, elevates operating temperatures and accelerates ageing of the oil. To reduce operating temperatures and avoid frequent oil changes, the circulating oil lubrication method is generally preferred (→ **fig. 42**). Cir-

culatation is usually controlled by a pump. After the oil has passed through the bearing, it generally settles in a tank where it is filtered and cooled before being returned to the bearing. Proper filtering decreases the contamination level and extends bearing service life. In bigger systems with several different bearing sizes, the main volume flow from the pump can be split into several smaller flows. The flow rate in each sub-circuit in the system can be checked by SKF flow monitoring devices.

Guideline values for oil flow rates are listed in **table 32**. For a more accurate analysis, contact the SKF application engineering service.

For information about the SKF CircOil system and SKF flow monitoring devices, refer to the product information available online at skf.com/lubrication.

Fig. 42

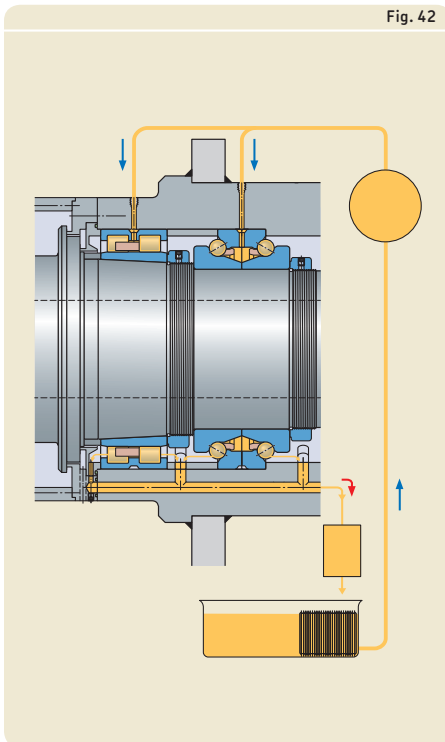

Table 32

Oil flow rate guidelines (valid for single bearings)

Bore diameter d	Oil flow rate Q		
	low	high	
over	incl.		
mm	l/min		
-	50	0,3	1
50	120	0,8	3,6
120	400	1,8	6

Oil jet

The oil jet lubrication method (→ **fig. 43**) is an extension of circulating oil systems. A jet of oil under high pressure is directed at the side of the bearing. The velocity of the oil jet should be sufficiently high (≥ 15 m/s) to penetrate the turbulence surrounding the rotating bearing. Oil jet lubrication is used for very high speed operation, where a sufficient, but not excessive, amount of oil should be supplied to the bearing without increasing the operating temperature unnecessarily.

Oil drop

With the oil drop method, an accurately metered quantity of oil is supplied to the bearing at given intervals. The delivered quantity may be relatively small, keeping frictional losses at high speeds to a minimum. However, it is difficult to ascertain whether the oil is able to penetrate the bearing at high speeds and, therefore, individual testing is always recommended. Whenever possible, the oil-air method should be preferred over the oil drop method.

Oil mist

Modern application specific oil mist systems, such as those offered by SKF, matched with a suitable non-toxic and non-carcinogenic oil formulated for minimum stray mist emissions and suitable sealing systems, address environmental and health concerns. These systems, when well maintained, provide a cost-effective, environmentally clean way to continuously and effectively atomise oil and deliver metered minimum required quantities to the bearings. Modern oil mist systems suspend oil droplets 1 to 5 μm in size in dry instrument air. The oil to air ratio, which is typically 1:200 000, creates a very lean but effective mixture that is delivered under 0,005 MPa pressure.

Fig. 43

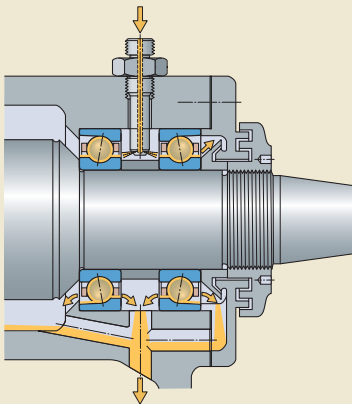

Oil-air

Oil-air lubrication systems are appropriate for high-precision applications with very high operating speeds and requisite low operating temperatures. For information about the SKF Oil+Air lubrication systems, refer to the product information available online at skf.com/lubrication.

The oil-air method (→ **fig. 44**), also called the oil-spot method, uses compressed air to transport small, accurately metered quantities of oil as small droplets along the inside of feed lines to an injector nozzle, where it is delivered to the bearing (→ **fig. 45**). This minimum quantity lubrication method enables bearings to operate at very high speeds with relatively low operating temperature. The compressed air serves to cool the bearing and also produces an excess pressure in the bearing housing to prevent contaminants from entering. Because the air is only used to transport the oil and is not mixed with it, the oil is retained within the housing. Oil-air systems are con-

sidered to be environmentally safe, provided that any residual used oil is disposed of correctly.

For bearings used in sets, each bearing should be supplied by a separate injector. Most designs include special spacers that incorporate the oil nozzles.

Guideline values for the oil quantity to be supplied to an angular contact ball bearing for high-speed operation can be obtained from

$$Q = 1,3 d_m$$

Guideline values for the oil quantity to be supplied to a cylindrical roller bearing or double direction angular contact thrust ball bearing can be obtained from

$$Q = \frac{q d B}{100}$$

where

Q = oil flow rate [mm³/h]

B = bearing width [mm]

d = bearing bore diameter [mm]

d_m = bearing mean diameter [mm]
= 0,5 (d + D)

q = factor

= 1 to 2 for cylindrical roller bearings

= 2 to 5 for double direction angular contact thrust ball bearings

Individual testing is, however, always recommended in order to optimize the conditions.

Fig. 44

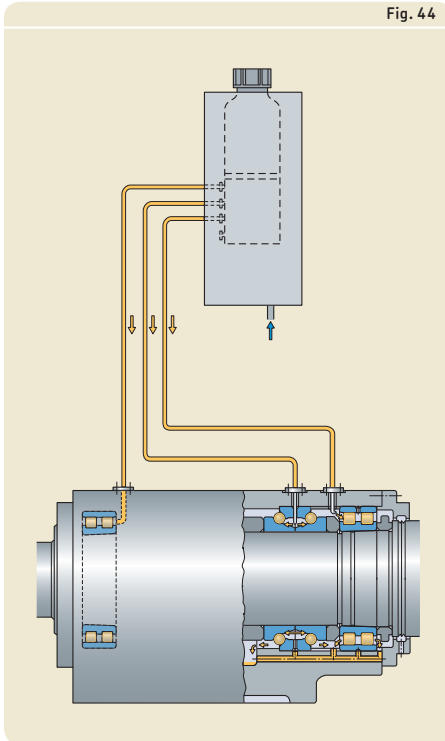
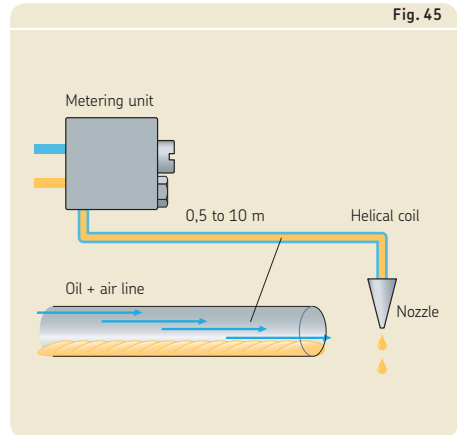

Fig. 45



Different bearing designs show varying sensitivity to oil quantity changes. For example, roller bearings are very sensitive, whereas for ball bearings, the quantity can be changed substantially without any major rise in bearing temperature.

A factor influencing temperature rise and reliability of oil-air lubrication is the lubrication interval, i.e. the time in between two measures from the oil-air lubricator. Generally, the lubrication interval is determined by the oil flow rate generated by each injector and the oil quantity supplied per hour. The interval can vary from one minute to one hour, with the most common interval being 15 to 20 minutes.

Feed lines from the lubricator are 1 to 5 m in length, depending on the lubrication interval. A filter that prevents particles $> 5 \mu\text{m}$ from reaching the bearings should be incorporated. The air pressure should be 0,2 to 0,3 MPa, but should be increased for longer runs to compensate for the pressure drop along the pipe's length.

To maintain the lowest possible operating temperature, ducts must be able to drain any excess oil away from the bearing. With horizontal shafts it is relatively easy to arrange drainage ducts on each side of the bearings. For vertical shafts the oil passing the upper bearing(s) should be prevented from reaching the lower bearings, which would otherwise receive too much lubricant. Drainage, together with a sealing device, should be incorporated beneath each bearing. An effective seal should also be located at the spindle nose to prevent lubricant from reaching the work piece.

The oil nozzles should be positioned so that oil can be introduced into the contact area between the rolling elements and raceways without interference by the cage. For the diameter (measured on the bearing) where oil injection should take place, refer to **tables 33** and **34** (\rightarrow **pages 118** and **119**). For bearings equipped with alternative cages that are not listed, contact the SKF application engineering service.

The attainable speeds listed in the product tables for oil lubrication refer specifically to oil-air lubrication.

Oil nozzle position for angular contact ball bearings

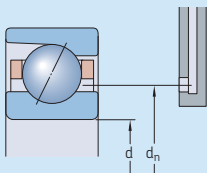

Bore diameter d	Size	Oil nozzle position d_n for bearings in the series							
		718 CD 718 ACD	719 CD 719 ACD	719 CE 719 ACE	719 CB 719 ACB	70 CD 70 ACD	70 CE 70 ACE	70 CB 70 ACB	72 CD 72 ACD
mm	–	mm							
6	6	–	–	–	–	10,3	10,1	–	–
7	7	–	–	–	–	11,7	11,4	–	13,6
8	8	–	–	12,2	–	13,6	13,3	–	14,3
9	9	–	–	13,3	–	15,1	14,8	–	16,3
10	00	13,4	14,8	14,8	–	16	16,5	–	18,3
12	01	15,4	16,8	16,8	–	18	18,5	–	20
15	02	18,4	20,1	20	–	21,5	21,9	–	23
17	03	20,4	22,1	22	–	23,7	24,1	–	25,9
20	04	24,5	26,8	26,7	–	28,4	28,1	–	31,1
25	05	29,5	31,8	31,8	–	33,4	33,1	–	36,1
30	06	34,5	36,8	36,8	36,6	39,3	39,9	40	42,7
35	07	39,5	43	43	43	45,3	45,6	46,1	49,7
40	08	44,5	48,7	48	49,1	50,8	51,6	51,6	56,2
45	09	50	54,2	54,2	54,2	56,2	57,6	57,2	60,6
50	10	55,6	58,7	58,4	58,7	61,2	62,3	61,8	65,6
55	11	61,3	64,7	64,6	64,8	68,1	69,6	69,2	72,6
60	12	66,4	69,7	69,6	69,8	73,1	74,6	74,2	80,1
65	13	72,4	74,7	74,5	74,8	78,1	79,3	79	86,6
70	14	77,4	81,7	81,5	81,9	85	86,5	86,1	91,6
75	15	82,4	86,7	86,5	86,9	90	91,5	91,1	96,6
80	16	87,4	91,7	91,5	91,7	96,9	98,5	98	103,4
85	17	94,1	98,6	98,6	99,2	101,9	103,5	103	111,5
90	18	99,1	103,3	103,5	103,9	108,7	111	110	117,5
95	19	104,1	108,6	108,5	109	113,7	115,4	115	124,4
100	20	109,1	115,6	115,4	116,1	118,7	120,4	120	131,4
105	21	114,6	120,6	–	–	125,6	–	–	138,4
110	22	120,9	125,6	125,4	125,7	132,6	135,4	134,6	145,9
120	24	130,9	137,6	137,4	138,2	142,6	144,9	144,7	158,2
130	26	144	149,5	–	–	156,4	–	–	170,7
140	28	153,2	159,5	–	–	166,3	–	–	184,8
150	30	165,6	173,5	–	–	178,2	–	–	–
160	32	175,6	183,5	–	–	191,4	–	–	–
170	34	–	193,5	–	–	205,8	–	–	–
180	36	–	207,4	–	–	219,7	–	–	–
190	38	–	217,4	–	–	229,7	–	–	–
200	40	–	231,4	–	–	243,2	–	–	–
220	44	–	251,4	–	–	267,1	–	–	–
240	48	–	271,4	–	–	287	–	–	–
260	52	–	299,7	–	–	315	–	–	–
280	56	–	319,7	–	–	–	–	–	–
300	60	–	347	–	–	–	–	–	–
320	64	–	367	–	–	–	–	–	–
340	68	–	387	–	–	–	–	–	–
360	72	–	407	–	–	–	–	–	–

Table 34

Oil nozzle position for cylindrical roller and double direction angular contact thrust ball bearings

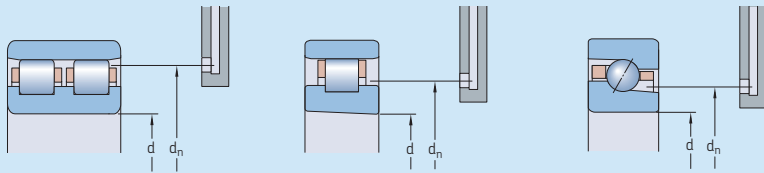

Bore diameter d	Size	Oil nozzle position d_n for bearings in the series ¹⁾			
		N 10 NN 30	N 10 PHA	NNU 49	BTM
mm	–	mm			
25	05	40,5	–	–	–
30	06	47,6	–	–	–
35	07	54	–	–	–
40	08	60	52,1	–	–
45	09	66,4	57,9	–	–
50	10	71,4	63	–	–
55	11	79,8	70,1	–	–
60	12	85	75,2	–	73,8
65	13	89,7	80,1	–	78,8
70	14	98,5	87,7	–	86,1
75	15	103,5	92,7	–	91,1
80	16	111,4	99,3	–	97,9
85	17	116,5	–	–	102,9
90	18	125,4	–	–	109,7
95	19	130,3	–	–	114,7
100	20	135,3	–	113,8	119,7
105	21	144,1	–	119	–
110	22	153	–	124	134,1
120	24	162,9	–	136,8	144,1
130	26	179,6	–	147	158,3
140	28	188	–	157	168,3
150	30	201,7	–	169,9	179,9
160	32	214,4	–	179,8	191,6
170	34	230,8	–	189,8	205,4
180	36	248,9	–	203,5	219,9
190	38	258,9	–	213	–
200	40	275,3	–	227	–
220	44	302,4	–	247	–
240	48	322,4	–	267	–
260	52	355,2	–	294,5	–
280	56	375,3	–	313,5	–

The illustrations show examples only. Position depends on design and series.

¹⁾ For bearings in the N 10 series equipped with an TNHA cage, bearings in the NN 30 and NNU 49 series with $d > 280$ mm, contact the SKF application engineering service.

Direct oil-air lubrication

For super-precision angular contact ball bearings operating at very high speeds, the injection of small amounts of oil-air directly through the outer ring is beneficial. With this method, lubricant dispersion is prevented, as the lubricant is supplied directly and safely to the ball/raceway contact area. As a result, lubricant consumption is minimized and bearing performance is improved. The different variants (→ fig. 45) for direct oil-air lubrication provide different benefits:

- Bearings with an annular groove and O-rings in the outer ring (designation suffix L or L1) prevent lubricant leakage between the bearing and its seat in the housing. For bearings without these features (designation suffix H or H1), SKF recommends machining the housing bore and incorporating O-rings into the bearing arrangement design.
- Bearings with lubrication holes on the thick side of the bearing shoulder (designation suffix H1 or L1) enable the lubricant to be supplied very close to the ball/raceway contact area. The locations of these lubrication holes enable the bearings to achieve maximum speeds.

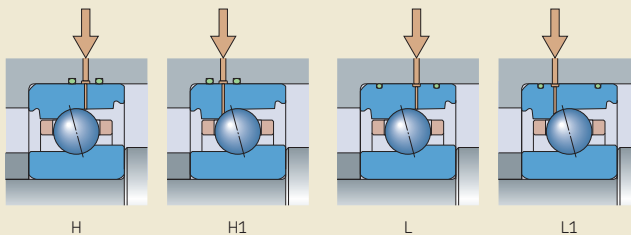

Fig. 45

Fig. 46

Direct minimum quantity lubrication with minimal air consumption

The use of a continuous air flow in an oil-air lubrication system includes some system-related disadvantages like the high cost of compressed air, high noise levels and a complex dosing and control process. The SKF Microdosage system (→ fig. 46) virtually eliminates these disadvantages and offers better control and a lower cost of ownership.

Designed for ultra high speed spindles where the speed factor $A \geq 2\,000\,000$ mm/min, this system delivers precisely metered amounts of oil to each bearing based on the machine tool's CAM program. The SKF Microdosage system also automatically re-calibrates when conditions like temperature or oil viscosity change. With this technology, oil consumption can typically be reduced to 0,5 to 5 mm³/min with a minimal amount of compressed air.

For information about the SKF Microdosage system, refer to the product information available online at skf.com/lubrication.

Lubricating oils

To lubricate super-precision bearings, high-quality lubricating oils without EP additives are generally recommended. The requisite viscosity of the oil can be determined following the recommendations under *Lubrication conditions – the viscosity ratio κ* in the SKF catalogue *Rolling bearings* or at skf.com, and is essentially a function of bearing size, speed and operating temperature.

Calculations can be made using the SKF program, Viscosity, available online at skf.com/bearingcalculator.

With oil-air lubrication systems, many oil types are suitable. Oils with a viscosity of 40 to 100 mm²/s at 40 °C (105 °F) are typically used as are oils with EP additives which are preferable, especially for roller bearings. Oils with a viscosity of 10 to 15 mm²/s at 40 °C (105 °F) are typically used for oil jet lubrication, whereas oil mist lubrication systems typically use oils with a viscosity of 32 mm²/s at 40 °C (105 °F).

The intervals at which the oil should be changed when using an oil bath, circulating oil or oil jet lubrication system, depend mainly on the operating conditions and the quantity of oil involved. When oil drop, oil mist or oil-air lubrication systems are used, the lubricant is supplied to the bearings only once.

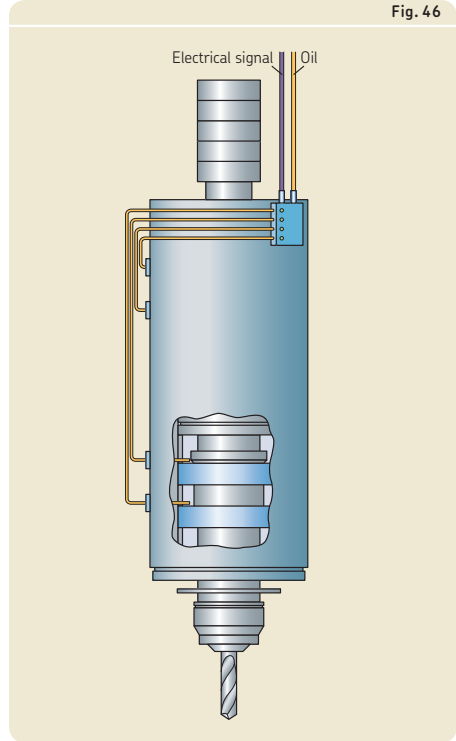

Oil cleanliness

Oil cleanliness, which affects bearing service life and performance, requires an effective sealing system. Even with effective seals, however, the condition of the oil should be monitored on a regular basis. This is particularly true for oil re-circulation systems where the ingress of coolants, cutting oils, and other liquid contaminants can alter the lubricating properties of the oil.

Oil cleanliness requirements can be described by the number of particles per millilitre of oil for different particle sizes. ISO 4406 provides a coding system for the level of solid contaminants. The oil cleanliness requirements for high-precision applications like electro-spindles go beyond this coding. The maximum particle size should not exceed 5 μm . The acceptable contamination levels can be specified as an extrapolation of the contamination codes to ISO 4406 (\rightarrow **diagram 18**):

- 10/7, for new spindles
- 13/10, after long use (~ 2 000 hours)

Lubricant storage

The conditions under which lubricants are stored can have an adverse effect on their performance. Inventory control can also play an important role. Therefore, SKF recommends a “first in, first out” inventory policy.

Lubricant properties may vary considerably during storage due to exposure to air/oxygen, temperature, light, water, moisture and other contaminants, or oil separation. Therefore, lubricants should be stored in a cool, dry, indoor area and should never be exposed to direct sunlight. The lubricants should be stored in their original containers, which should be kept closed until needed. After use, the containers should be resealed immediately.

The recommended maximum storage time is two years for greases and ten years for lubricating oils; assuming reasonable stock keeping practices and protection from excessive heat and cold.

Grease or oil that has exceeded the recommended shelf life is not necessarily unsuitable for service. However, it is advisable to confirm that the lubricant still meets the product requirements and specifications.

Diagram 18

Acceptable oil contamination levels

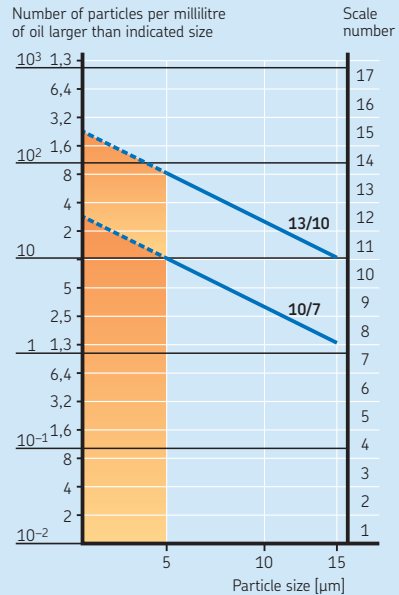

Mounting and dismounting

When mounting or dismounting super-precision bearings, all recommendations and guidelines valid for rolling bearings should be considered. For recommendations and guidelines, refer to *Mounting, dismounting and bearing care* in the SKF catalogue *Rolling bearings* or at skf.com and to the *SKF bearing maintenance handbook* (ISBN 978-91-978966-4-1). For mounting and dismounting instructions for individual bearings, visit skf.com/mount.

Where to mount

Bearings should be mounted in a dry, dust-free area away from machines producing swarf and dust. When bearings have to be mounted in an unprotected area, steps should be taken to protect the bearing and mounting position from contaminants like dust, dirt and moisture. This can be done by covering or wrapping the bearings and machine components with plastic or foil.

Methods and tools

Super-precision bearings are reliable machine elements that can provide long service life, provided they are mounted and maintained properly. Proper mounting requires experience, accuracy, a clean work environment and the appropriate tools.

To promote proper mounting techniques, speed, accuracy and safety, SKF offers a comprehensive assortment of high-quality mounting and maintenance products. The assortment includes everything from mechanical and hydraulic tools to bearing heaters and grease. Detailed information about maintenance products is available online at skf.com.

To be sure that bearings are mounted and maintained properly, SKF offers seminars and hands-on training courses as part of the SKF Reliability Systems concept. Mounting and maintenance assistance may also be available from your local SKF company or SKF Authorized Distributor.

Mounting recommendations

Compared to other rolling bearings, mounting super-precision bearings requires more accuracy, more caution and more advanced skills.

Mounting bearings with thin-walled rings

Super-precision bearings often have rings that are thin relative to their size. For these bearings, only limited mounting forces should be applied. Therefore, SKF recommends using hot mounting methods for all super-precision bearings with thin-walled rings. For bearings in the NNU 49 series with a tapered bore, SKF recommends using the oil injection method.

Hot mounting

Super-precision bearings are typically mounted with a low degree of interference. That means a relatively small difference in temperature between the bearing ring and its mating components is required. The following temperature differences are often sufficient:

- 20 to 30 °C (35 to 55 °F) between the inner ring and shaft
- 10 to 30 °C (20 to 55 °F) between the housing bore and outer ring

To heat bearings evenly and reliably, SKF recommends using SKF electric induction heaters (→ [fig. 47](#)).

Stepped sleeves are sometimes used to locate bearings on a shaft and are therefore installed with a tight interference fit. Because of this, stepped sleeves require a greater dif-

Fig. 47

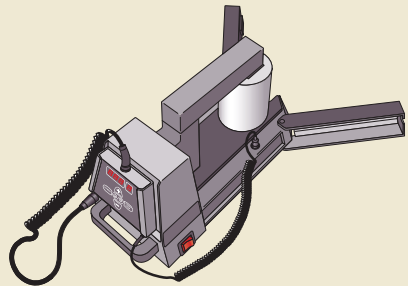

ference in temperature between mating components during installation. Temperature differences for installation are listed for:

- stepped sleeves without O-rings (→ **table 16, page 82**)
- stepped sleeves with O-rings (→ **table 17, page 83**)

Test running

Once assembly is complete, an application should undergo a test run to determine that all components are operating properly. During a test run, the bearing(s) should run under partial load and, where there is a wide speed range, at low or moderate speeds. A rolling bearing should never be started up unloaded and then accelerated to high speed, as there is a significant risk that the rolling elements will slide and damage the raceways, or that the cage will be subjected to impermissible stresses.

Any noise or vibration can be checked using an SKF electronic stethoscope. Normally, bearings produce an even “purring” noise. Whistling or screeching indicates inadequate lubrication. An uneven rumbling or hammering is in most cases due to the presence of contaminants in the bearing or to bearing damage caused during mounting.

An increase in bearing temperature immediately after start-up is normal. In the case of grease lubrication, the temperature does not drop until the grease has been evenly distributed in the bearing arrangement, after which an equilibrium temperature is reached. For additional information about running-in of grease lubricated bearings, refer to *Running-in of grease lubricated bearings* (→ **page 111**).

Unusually high temperatures or constant peaking indicate that the preload is too heavy, that there is too much lubricant in the arrangement or that the bearing is radially or axially distorted. Other causes could be that associated components have not been made or mounted correctly, or that the seals are generating too much heat.

During the test run, or immediately afterwards, check the seals, any lubrication systems and all fluid levels. If noise and vibration levels are severe, it is advisable to check the lubricant for signs of contamination.

Dismounting

Because the degree of the interference fit is relatively low for super-precision bearings, lower ring dismounting forces are needed compared to other rolling bearings.

Dismounting forces

For bearings in spindle applications, the dismounting forces can be estimated as follows:

- dismounting a set of three angular contact ball bearings from the housing → $F \sim 0,02 D$
- dismounting a set of three angular contact ball bearings from the shaft → $F \sim 0,07 d$
- dismounting a cylindrical roller bearing from its tapered seat → $F \sim 0,3 d$

where

F = dismounting force [kN]

D = bearing outside diameter [mm]

d = bearing bore diameter [mm]

Reusing bearings

To determine if a bearing can be reused, it must be inspected carefully. A detailed inspection requires disassembling the bearing. Angular contact ball bearings cannot be disassembled without damage unless special tools are used. Cylindrical roller bearings can only be partly disassembled.

SKF does not recommend reusing super-precision bearings. In most cases, the risk for unplanned downtime or unsatisfactory performance outweighs the cost of new bearings.

Bearings should be dismounted carefully, regardless of whether they will be reused, because careless dismounting could damage associated components. Also, if the bearing is dismounted carefully, it can then be used for condition and damage analysis if required.

SKF spindle service

Machine tool spindles often require special tools and skills for maintenance and repair. SKF supports customers with a worldwide network of SKF Spindle Service Centres (→ [skf.com](https://www.skf.com)). The services offered include spindle reconditioning, from bearing replacement to shaft and nose restorations, performance upgrades and analysis. SKF can also provide complete monitoring services as well as preventative maintenance services for machine tool spindles.

Bearing storage

The conditions under which bearings and seals are stored can have an adverse effect on their performance. Inventory control can also play an important role in performance, particularly if seals are involved. Therefore, SKF recommends a “first in, first out” inventory policy.

Storage conditions

To maximize the service life of bearings, SKF recommends the following basic housekeeping practices:

- Store bearings flat, in a vibration-free, dry area with a cool, steady temperature.
- Control and limit the relative humidity of the storage area as follows:
 - 75% at 20 °C (68 °F)
 - 60% at 22 °C (72 °F)
 - 50% at 25 °C (77 °F)
- Keep bearings in their original unopened packages until immediately prior to mounting to prevent the ingress of contaminants and corrosion.
- Bearings that are not stored in their original packaging should be well protected against corrosion and contaminants.

Shelf life of open bearings

SKF bearings are coated with a rust-inhibiting compound and suitably packaged before distribution. For open bearings, the preservative provides protection against corrosion for approximately three years, provided the storage conditions are appropriate.

Shelf life of sealed bearings

The maximum storage interval for sealed SKF bearings is dictated by the lubricant inside the bearings. Lubricant deteriorates over time as a result of ageing, condensation, and separation of the oil and thickener. Therefore, sealed bearings should not be stored for more than three years.

Super-precision bearing

SKF



Angular contact ball bearings

Assortment	128	Fitting and clamping bearing rings . . .	183
Designs and variants	128	Calculating the required tightening torque	184
Bearing series	130	Locking procedure	185
Contact angles	130	Load carrying capacity of bearing sets	189
High-capacity D design bearings	131	Equivalent bearing loads	190
High-speed E design bearings	132	Equivalent dynamic bearing load	190
High-speed B design bearings	132	Equivalent static bearing load	191
Hybrid bearings	133	Attainable speeds	192
Cages	134	Mounting	194
Sealing solutions	136	Pressing bearing sets together during hot mounting	194
Direct oil-air lubrication	136	Package markings	194
Bearings made of NitroMax steel	141	Designation system	196
Bearing arrangement design	141	Product table	
Single bearings and bearing sets	141	2.1 Angular contact ball bearings	198
Single bearings	141		
Bearing sets	142		
Bearing arrangements	142		
Markings on bearings and bearing sets	145		
Bearing data	146		
(Boundary dimensions, chamfer dimensions, tolerances)			
Preload	151		
Bearings manufactured pre-set for preload	151		
Preload in mounted bearing sets	162		
Preload with a constant force	165		
Preload by axial displacement	166		
Individual adjustment of preload	166		
Spacer rings	167		
Effect of rotational speed on preload	167		
Axial stiffness	173		
		More information	
		Bearing life and load ratings	33
		Requisite minimum load	34
		Chamfer dimension limits	47
		Materials	51
		Design considerations	57
		Lubrication	99
		Mounting and dismounting	123
		Bearing storage	125

Assortment

SKF manufactures super-precision angular contact ball bearings for shaft diameters from 6 to 360 mm. Application requirements vary, and as a result, the SKF assortment of super-precision angular contact ball bearings includes four ISO dimension series, in numerous executions. The wide selection of designs and variants enables them to be incorporated into virtually every machine tool application as well as other applications where precision bearings are required.

SKF can supply super-precision angular contact ball bearings with a variety of design features:

- three different contact angles
- three different ball sizes
 - D design (→ **page 131**)
 - E design (→ **page 132**)
 - B design (→ **page 132**)
- two different ball materials (hybrid variant)
- sealing solutions
- direct oil-air lubrication features
- two different ring materials (NitroMax steel variant)

The assortment of super-precision angular contact ball bearings is shown in **table 1**.

Designs and variants

Single row SKF super-precision angular contact ball bearings (→ **fig. 1**) are non-separable and, like all angular contact ball bearings, have raceways in the inner and outer rings that are displaced relative to each other in the direction of the bearing axis. This means that in addition to radial loads, these bearings can also accommodate axial loads in one direction. Radial loads induce axial forces in these bearings that need to be balanced by counterforces. An angular contact ball bearing is, therefore, always adjusted against a second bearing or used in sets.

The ring shoulders can have a different height on one or both bearing rings. Every bearing has the largest possible number of balls, which are guided by a window-type cage.

Fig. 1

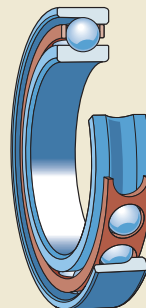

Table 1

Super-precision angular contact ball bearings – assortment

ISO dimension series	Bearing design	Open variant		Sealed variant	
18	High-capacity, D design		d = 10 to 160 mm D = 19 to 200 mm	–	–
19	High-capacity, D design		d = 10 to 360 mm D = 22 to 480 mm		d = 10 to 150 mm D = 22 to 210 mm
	High-speed, E design		d = 8 to 120 mm D = 19 to 165 mm		d = 20 to 120 mm D = 37 to 165 mm
	High-speed, B design		d = 30 to 120 mm D = 47 to 165 mm		d = 30 to 120 mm D = 47 to 165 mm
10	High-capacity, D design		d = 6 to 260 mm D = 17 to 400 mm		d = 10 to 150 mm D = 26 to 225 mm
	High-speed, E design		d = 6 to 120 mm D = 17 to 180 mm		d = 10 to 120 mm D = 26 to 180 mm
	High-speed, B design		d = 30 to 120 mm D = 55 to 180 mm		d = 30 to 120 mm D = 55 to 180 mm
02	High-capacity, D design		d = 7 to 140 mm D = 22 to 250 mm		d = 10 to 80 mm D = 30 to 140 mm

2

Bearing series

The SKF assortment of super-precision angular contact ball bearings includes bearings in the following dimension series:

- ultra light 718 series
- extremely light 719 series
- light 70 series
- robust 72 series

The cross sections of the four bearing series are compared in **fig. 2** for the same bore and same outside diameters. Each bearing series has characteristic features that make it particularly suitable for certain bearing applications.

Where a low cross-sectional height is a critical design parameter, bearings in the 718 series should be selected. If more radial space is available, and loads are not very heavy, bearings in the 719 or 70 series could be used. Bearings in the 72 series have the largest cross-sectional height for a given bore diameter and are suitable for heavy loads at relatively low speeds.

If a high degree of stiffness is required, bearings in the 718 and 719 series are typically used. Bearings in these two series contain the largest number of balls, relative to the

selected bore size, and can also accommodate the largest shaft diameter, relative to their outside diameter. Both characteristics are particularly important for system rigidity, as the rigidity of a spindle increases with its shaft diameter, and the rigidity of a bearing arrangement increases with the number of balls.

Contact angles

Super-precision angular contact ball bearings are manufactured with the following contact angles (→ **fig. 3**):

- a 15° contact angle, designation suffix C
- a 25° contact angle, designation suffix AC

For some series, bearings with an 18° contact angle, designation suffix F, are available on request.

A larger contact angle provides a higher degree of axial stiffness and a higher axial load carrying capacity. However, speed capability, radial stiffness, and radial load carrying capacity are reduced.

Fig. 2

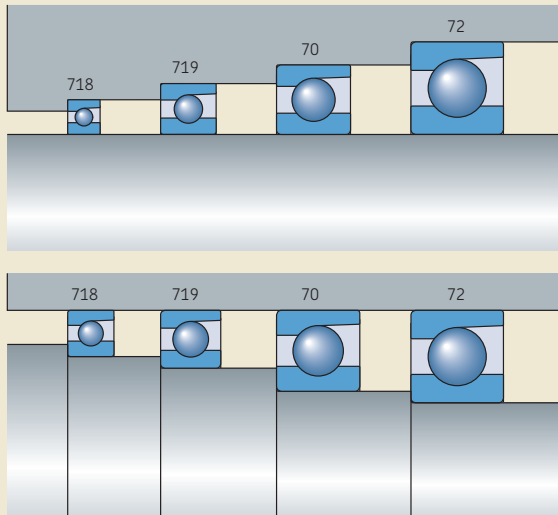

High-capacity D design bearings

D design bearings (→ **fig. 4**) are designed to accommodate heavy loads at relatively high speeds under low to moderate operating temperatures. When compared to other precision angular contact ball bearings, D design bearings contain the maximum number and size of balls. Their close osculation provides a relatively high degree of stiffness and the highest possible load carrying capacity.

Applications

Typical applications for bearings in the 718 .. D series include:

- machine tools, e.g. multispindle drilling heads (→ **fig. 14, page 60**)
- robotics
- printing
- measuring systems
- racing car wheels

Typical applications for bearings in the 719 .. D and 70 .. D series include:

- machining centres (horizontal and vertical) (→ **fig. 17, page 63**)
- milling machines
- lathes (→ **fig. 11, page 58**)
- external and surface grinding machines
- boring machines
- machines for cutting or polishing stones and glass
- semiconductor industry, e.g. units for detecting defects on silicon wafer chips (→ **fig. 15, page 61**)
- boat gyrostabilizers
- telescopes
- microturbines
- racing/super car wheels
- medical equipment

Typical applications for bearings in the 72 .. D series include:

- machine tool spindles, e.g. live centre spindles (→ **fig. 13, page 59**)
- lathes (main spindles, tailstock)
- grinding machines
- boring machines
- Parallel Kinematic Machines (PKM)
- dynamometers for engine testing
- high-speed turbochargers

Fig. 3

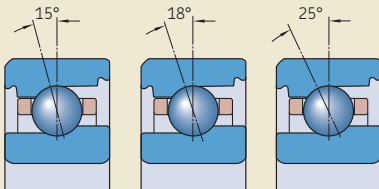
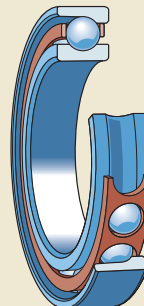

Fig. 4



High-speed E design bearings

E design bearings (→ **fig. 5**), when compared to D design bearings, have a more open osculation and a maximum number of smaller balls. They can therefore accommodate very high speeds but do not have the same high load carrying capacity as D design bearings. Compared to B design bearings, E design bearings have a slightly higher speed capability and can accommodate heavier loads.

Applications

Typical applications for bearings in the 719 .. E and 70 .. E series include:

- electro-spindles (→ **fig. 16, page 62**)
- high-speed machining centres (horizontal and vertical) (→ **fig. 17, page 63**)
- high-speed milling machines
- high-speed internal grinding machines (→ **fig. 19, page 64**)
- high-speed spindles for PCB drilling
- woodworking machines

High-speed B design bearings

B design bearings (→ **fig. 6**) are designed for high-speed operation and are best suited for lighter loads and lower operating temperatures. When compared to E and D design bearings, B design bearings are equipped with the maximum number of very small balls. The smaller, lighter balls reduce the centrifugal loads acting on the outer ring raceway and therefore reduce the stresses on the rolling contact surfaces. As smaller balls require less space, the bearing rings have a larger cross-sectional height, making them less susceptible to distortion resulting from irregularities of the bearing seat, either on the shaft or in the housing.

Applications

Typical applications for bearings in the 719 .. B and 70 .. B series include:

- electro-spindles (→ **fig. 18, page 63**)
- metal cutting machines (→ **fig. 18**)
- woodworking machines
- milling machines
- machining centres

Fig. 5

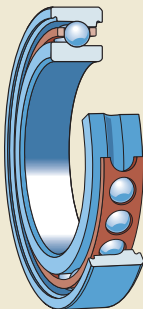
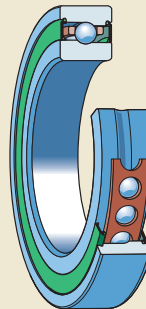

Fig. 6



Hybrid bearings

Hybrid angular contact ball bearings (designation suffix HC) have rings made of bearing steel and rolling elements made of bearing grade silicon nitride (ceramic). As ceramic balls are lighter and have a higher modulus of elasticity and lower coefficient of thermal expansion than steel balls, hybrid bearings can provide the following advantages:

- higher degree of rigidity
- higher speed capability
- reduced centrifugal and inertial forces within the bearing
- minimized stress at the outer ring rolling contacts at high speeds
- reduced frictional heat
- less energy consumption
- extended bearing and grease service life
- less prone to skid smearing damage and cage damage when subject to frequent rapid starts and stops
- less sensitive to temperature differences within the bearing
- more accurate preload/clearance control

For additional information about silicon nitride, refer to *Materials for bearing rings and rolling elements* (→ **page 51**).

Angular contact ball bearings

Cages

Depending on their series and size, single row super-precision angular contact ball bearings are fitted as standard with one of the following cages (→ **matrix 1**):

- a cotton fabric reinforced phenolic resin cage, window-type, outer ring centred, no designation suffix (→ **fig. 7**)
- a glass fibre reinforced PEEK cage, window-type, outer ring centred, designation suffix TNHA (→ **fig. 8**)
- a carbon fibre reinforced PEEK cage, window-type, outer ring centred, no designation suffix (→ **fig. 9**)
- a machined brass cage, window-type, outer ring centred, designation suffix MA

The lightweight polymer cages reduce inertial and centrifugal forces while maximizing the effectiveness of the lubricant.



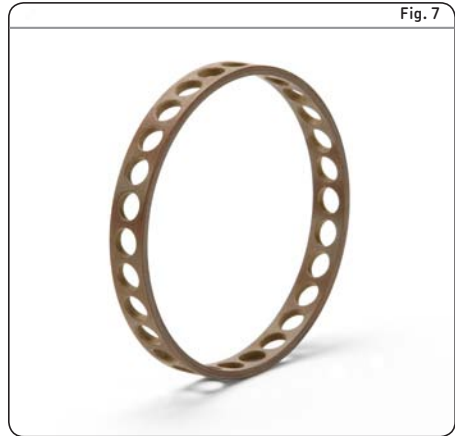

Other cage materials and designs are available on request. Contact the SKF application engineering service.

For additional information about materials, refer to *Cage materials* (→ **page 55**).



Matrix 1

Bore diameter [mm]	Cage materials for bearings in the series								Size
	718 .. D	719 .. D	70 .. D	719 .. E	70 .. E	719 .. B	70 .. B	72 .. D	
6									6
7									7
8									8
9									9
10									00
12									01
15									02
17									03
20									04
25									05
30									06
35									07
40									08
45									09
50									10
55									11
60									12
65									13
70									14
75									15
80									16
85									17
90									18
95									19
100									20
105									21
110									22
120									24
130									26
140									28
150									30
160									32
170									34
180									36
190									38
200									40
220									44
240									48
260									52
280									56
300									60
320									64
340									68
360									72

-  Cotton fabric reinforced phenolic resin
-  Glass fibre reinforced PEEK
-  Carbon fibre reinforced PEEK
-  Machined brass

Sealing solutions

The most common bearings can be supplied with an integral seal fitted on both sides (designation prefix S). The seal forms an extremely narrow gap with the inner ring shoulder (→ **fig. 10**), and therefore speed capability is not compromised.

The seals are made standard of an oil- and wear-resistant NBR and are reinforced with sheet steel. On request, bearings can be supplied with seals made of FKM. For additional information, refer to *Seal materials* (→ **page 56**).

Sealed bearings are filled as standard with a high-quality, low-viscosity grease that has a lithium soap thickener and a synthetic ester base oil. The quantity of grease fills ~ 15% of the free space in the bearing. The temperature range for the grease is -55 to $+110$ °C (-65 to $+230$ °F). On request, the bearings can be supplied with other greases. For additional information, contact the SKF application engineering service.

When compared to bearing arrangements with open bearings and external seals, sealed bearings can provide a number of advantages, including:

- potential for extended bearing service life
- extended maintenance intervals
- reduced inventory
- reduced risk of lubricant contamination during mounting and operation

Sealed bearings are lubricated for life. They should not be washed or heated to temperatures above 80 °C (175 °F). If a sealed bearing is to be heated for mounting, an induction heater must be used and the bearing should be fitted immediately to minimize the time that the bearing is exposed to high temperatures. For information about the storage interval of sealed bearings, refer to *Shelf life of sealed bearings* (→ **page 125**).

Direct oil-air lubrication

Some very high speed applications require open bearings in the 719 .. D and 70 .. D series, 719 .. E and 70 .. E series, and 719 .. B and 70 .. B series to be lubricated with minimal amounts of oil, directly through their outer rings.

On request, bearings can be supplied with two lubrication holes in their outer rings. Bearings with an annular groove or an annular groove and two annular O-ring grooves, complete with O-rings to seal to the bearing housing bore, are also available. The positions of these features are listed in the following tables:

- **table 2** for bearings in the 719 .. D and 70 .. D series
- **table 3** (→ **page 138**) for bearings in the 719 .. E and 70 .. E series
- **table 4** (→ **page 140**) for bearings in the 719 .. B and 70 .. B series

Fig. 10

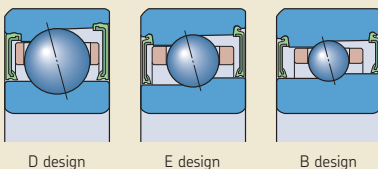
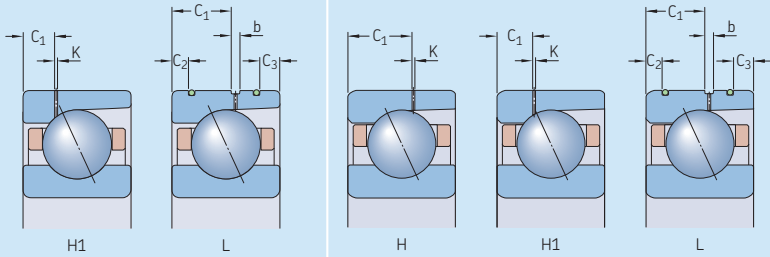

Table 2

Dimensions for direct oil-air lubrication – 719 .. D and 70 .. D series



Bore diameter d	Size	Dimensions Variants for bearings in the 719 .. D series						Variants for bearings in the 70 .. D series							
		H1		L				H		H1		L			
		C ₁	K	C ₁	C ₂	C ₃	b	C ₁	K	C ₁	K	C ₁	C ₂	C ₃	b
mm	-	mm													
6	6	-	-	-	-	-	-	3,65	0,5	-	-	-	-	-	-
7	7	-	-	-	-	-	-	3,65	0,5	-	-	-	-	-	-
8	8	-	-	-	-	-	-	4,25	0,5	-	-	-	-	-	-
9	9	-	-	-	-	-	-	4,25	0,5	-	-	-	-	-	-
10	00	-	-	-	-	-	-	4,75	0,5	-	-	-	-	-	-
12	01	-	-	-	-	-	-	4,9	0,5	-	-	-	-	-	-
15	02	-	-	-	-	-	-	5,35	0,5	-	-	-	-	-	-
17	03	-	-	-	-	-	-	6,05	0,5	-	-	-	-	-	-
20	04	-	-	-	-	-	-	7,15	0,5	-	-	-	-	-	-
25	05	-	-	-	-	-	-	7,25	0,5	-	-	-	-	-	-
30	06	-	-	-	-	-	-	7,8	0,5	-	-	-	-	-	-
35	07	-	-	-	-	-	-	8,4	0,5	-	-	-	-	-	-
40	08	-	-	-	-	-	-	8,95	0,5	-	-	-	-	-	-
45	09	-	-	-	-	-	-	9,45	0,5	-	-	-	-	-	-
50	10	-	-	-	-	-	-	9,6	0,5	-	-	-	-	-	-
55	11	-	-	6,5	3,2	2	2,2	-	-	4,88	0,5	9	4,3	3,8	2,4
60	12	-	-	6,5	3,2	2	2,2	-	-	4,88	0,5	9	4,3	3,8	2,6
65	13	-	-	6,5	3,2	2	2,2	-	-	4,9	0,5	9,7	4,3	3,8	1,9
70	14	4,46	0,5	8,6	3,5	2,8	2	-	-	5,39	0,5	10,9	4,4	3,9	1,7
75	15	4,46	0,5	8,6	3,5	2,8	2	-	-	5,4	0,5	10,9	3,9	3,4	1,8
80	16	4,46	0,5	8,6	3,5	2,8	2	-	-	5,89	0,5	11,1	4,4	3,8	2,8
85	17	5,2	0,5	9,3	4	2,8	2,6	-	-	5,9	0,5	11,1	4,4	3,8	2,8
90	18	5,2	0,5	9,3	4,2	3	2,6	-	-	6,85	0,5	13,4	5,2	4,3	2,2
95	19	5,2	0,5	9,3	4,2	3	2,6	-	-	6,41	0,5	13,4	5,2	4,3	2,2
100	20	5,46	0,5	10,9	4	3,3	2,3	-	-	6,46	0,5	13,4	5,2	4	2,2
105	21	5,46	0,5	10,9	3,9	3,2	2,3	-	-	6,92	0,5	14,1	6,2	5	2,4
110	22	5,46	0,5	10,9	4	3	2,3	-	-	7,41	0,5	15,1	6,2	5,4	2,6
120	24	6,1	0,5	11,9	4,2	2,9	2,6	-	-	7,41	0,5	15	6,2	5,4	2,8
130	26	6,92	0,5	13,3	5,6	2,9	2,6	-	-	8,9	0,5	17,9	6,6	5,6	3,1
140	28	6,92	0,5	13,3	5,4	2,9	2,6	-	-	8,9	0,5	17,9	6,6	5,6	3,1
150	30	7,32	0,6	15,6	6,6	5,6	2,6	-	-	9,3	0,6	19,2	7,1	5,6	2,8
160	32	7,32	0,6	15,6	6,6	5,6	2,6	-	-	10,3	0,6	21,2	7,1	6,6	2,8
170	34	7,32	0,6	-	-	-	-	-	-	11,8	0,6	23,8	7,1	7,1	2,8
180	36	8,6	0,6	-	-	-	-	-	-	13,4	0,6	26,1	7,5	7,5	2,8
190	38	8,6	0,6	-	-	-	-	-	-	13,4	0,6	-	-	-	-
200	40	10	0,6	-	-	-	-	-	-	14	0,6	-	-	-	-
220	44	-	-	20,9	7,1	5,45	3,5	-	-	15,5	0,6	-	-	-	-
240	48	-	-	20,9	7,1	5,45	3,5	-	-	15,5	0,6	-	-	-	-
260	52	-	-	24,9	7,1	6,7	4	-	-	-	-	-	-	-	-



Dimensions for direct oil-air lubrication – 719 .. E series

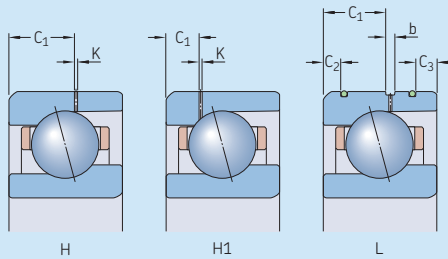

Bore diameter	Size	Dimensions							
		Variants for bearings in the 719 .. E series							
d		H C ₁	K	H1 C ₁	K	L C ₁	C ₂	C ₃	b
mm	–	mm							
8	8	3,65	0,5	–	–	–	–	–	–
9	9	3,65	0,5	–	–	–	–	–	–
10	00	3,65	0,5	–	–	–	–	–	–
12	01	3,65	0,5	–	–	–	–	–	–
15	02	4,3	0,5	–	–	–	–	–	–
17	03	4,35	0,5	–	–	–	–	–	–
20	04	5,45	0,5	–	–	4,6	1,4	0,9	1,5
25	05	5,45	0,5	–	–	4,6	1,4	0,9	1,5
30	06	5,45	0,5	–	–	4,6	1,4	0,9	1,5
35	07	6,15	0,5	–	–	5,1	1,8	1,2	1,6
40	08	–	–	3,75	0,5	5,9	1,8	1,8	2
45	09	–	–	3,75	0,5	5,9	2,3	1,8	2
50	10	–	–	3,53	0,5	5,9	2,3	1,8	2,2
55	11	–	–	3,83	0,5	6,5	2,5	2	2,2
60	12	–	–	3,83	0,5	6,5	2,5	2	2,2
65	13	–	–	3,83	0,5	6,5	2,5	2	2,2
70	14	–	–	4,9	0,5	8,6	2,8	2,8	2
75	15	–	–	4,9	0,5	8,6	2,8	2,8	2
80	16	–	–	4,9	0,5	8,6	2,8	2,8	2
85	17	–	–	5,48	0,5	9,3	3	3	2,6
90	18	–	–	5,48	0,5	9,3	3	3	2,6
95	19	–	–	5,48	0,5	9,3	3	3	2,6
100	20	–	–	6,05	0,5	10,9	3	3,3	2,3
110	22	–	–	5,78	0,5	10,9	3,5	3	2,3
120	24	–	–	6,31	0,5	11,9	4,2	3,6	2,6

Table 3b

Dimensions for direct oil-air lubrication – 70 .. E series

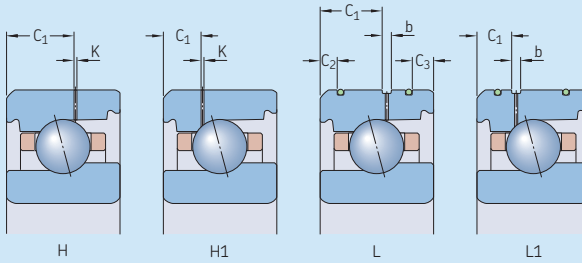

Bore diameter d	Size	Dimensions											
		Variants for bearings in the 70 .. E series											
		H C ₁	K	H1 C ₁	K	L C ₁	C ₂	C ₃	b	L1 C ₁	C ₂	C ₃	b
mm	-	mm											
6	6	3,65	0,5	-	-	-	-	-	-	-	-	-	-
7	7	3,65	0,5	-	-	-	-	-	-	-	-	-	-
8	8	4,25	0,5	-	-	-	-	-	-	-	-	-	-
9	9	4,25	0,5	-	-	-	-	-	-	-	-	-	-
10	00	4,75	0,5	-	-	-	-	-	-	-	-	-	-
12	01	4,9	0,5	-	-	-	-	-	-	-	-	-	-
15	02	5,35	0,5	-	-	-	-	-	-	-	-	-	-
17	03	6,05	0,5	-	-	-	-	-	-	-	-	-	-
20	04	-	-	3,67	0,5	5,9	1,8	1,9	1,9	3,2	1,45	1,9	1,4
25	05	-	-	3,72	0,5	5,9	1,8	1,9	2,1	3,2	1,45	1,9	1,4
30	06	-	-	4,23	0,5	6,5	2,3	2,6	1,8	3,7	1,95	2,6	1,4
35	07	-	-	4,52	0,5	7,3	2,2	2,8	1,7	4	2,2	2,8	1,4
40	08	-	-	5,03	0,5	7,8	2,5	3	1,7	4,5	2,5	3	1,4
45	09	-	-	5,53	0,5	8,6	3	3	1,7	5	3	3	1,4
50	10	-	-	5,32	0,5	8,6	2,7	3	1,7	4,7	2,7	3	1,6
55	11	-	-	6,30	0,5	9	3,4	3,4	2,4	5,65	3,4	3,4	1,6
60	12	-	-	6,30	0,5	9	3,4	3,4	2,4	5,65	3,4	3,4	1,6
65	13	-	-	5,92	0,5	9,7	3,3	3,3	1,9	5,3	3,3	3,3	1,6
70	14	-	-	6,7	0,5	10,9	3,4	3,4	1,9	6,05	3,4	3,4	1,6
75	15	-	-	6,73	0,5	10,9	3,4	3,4	1,8	6,1	3,4	3,4	1,6
80	16	-	-	7,27	0,5	11,1	3,8	3,8	2,8	6,5	3,8	3,8	1,8
85	17	-	-	7,27	0,5	11,1	3,8	3,8	2,8	6,5	3,8	3,8	1,8
90	18	-	-	8,33	0,5	13,2	4,3	4,3	2,6	7,6	4,3	4,3	1,8
95	19	-	-	7,81	0,5	13,4	4,3	4,3	2,2	7,1	4,3	4,3	1,8
100	20	-	-	7,82	0,5	13,4	4	4	2,2	7,1	4	4	1,8
110	22	-	-	9,84	0,5	15,1	5,4	5,4	2,6	9,05	5,4	5,4	1,8
120	24	-	-	9,38	0,5	15	5,4	5,4	2,8	8,6	5,4	5,4	1,8

Dimensions for direct oil-air lubrication – 719 .. B and 70 .. B series

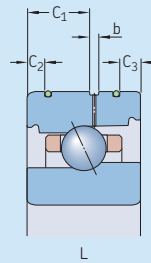
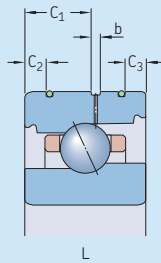

Bore diameter d	Size	Dimensions				Variant L for bearings in the 70 .. B series			
		C ₁	C ₂	C ₃	b	C ₁	C ₂	C ₃	b
mm	–	mm							
30	06	–	–	–	–	6,5	3,4	2,4	1,7
35	07	–	–	–	–	7,3	3,4	2,4	1,4
40	08	5,9	2,8	1,7	2	7,8	3,6	2,6	1,5
45	09	5,9	2,8	1,7	2	8,6	3,6	2,6	1,5
50	10	5,9	2,8	1,7	2	8,6	3,6	2,6	1,5
55	11	6,5	3,8	1,7	2	9	4,3	2,8	2,2
60	12	6,5	3,8	1,7	2	9	4,3	2,8	2,2
65	13	6,5	3,8	1,7	2	9,7	4,3	2,8	1,5
70	14	8,6	3,8	1,7	1,5	10,9	4,4	2,9	1,5
75	15	8,6	3,8	2,7	1,5	10,9	4,4	2,9	1,5
80	16	8,6	3,8	2,7	2	11,1	4,7	3,2	2,5
85	17	9,3	4,5	2,9	2,2	11,1	4,7	3,2	2,5
90	18	9,3	4,5	2,9	2,2	13,4	5,2	4,2	2,2
95	19	9,3	4,5	2,9	2,2	13,4	5,2	4,2	2,2
100	20	10,9	4,5	2,9	2,2	13,4	5,2	4,2	2,2
110	22	10,9	4,5	2,9	2,2	15,1	6,2	4,2	2,2
120	24	11,9	4,5	2,9	2,2	15,1	6,2	4,2	2,2

Bearings made of NitroMax steel

The rings of conventional super-precision hybrid angular contact ball bearings are made of carbon chromium steel. Hybrid bearings can, however, be supplied with rings made of NitroMax steel (designation prefix V), a new generation high-nitrogen stainless steel. Bearing rings made of this material have superior corrosion resistance, high wear resistance and enhanced fatigue strength, a high modulus of elasticity and a high degree of hardness and impact toughness.

The combined properties of NitroMax steel rings and balls made of bearing grade silicon nitride greatly improve bearing performance, enabling the bearings to run up to three times longer than conventional hybrid bearings, depending on the lubrication conditions.

These bearings are particularly suitable for very demanding applications such as high-speed machining centres and milling machines, where speed, rigidity, and bearing service life are key operational parameters.

For additional information about carbon chromium steel, ceramics, and NitroMax steel, refer to *Materials for bearing rings and rolling elements* (→ page 51).

Bearing arrangement design

Bearing arrangements using super-precision angular contact ball bearings can be specified as single bearings or as bearing sets.

An example of what options are available when ordering bearings for a three-bearing arrangement is provided in **table 5**.

Single bearings and bearing sets

Single bearings

Single, super-precision angular contact ball bearings are available as standalone bearings or as universally matchable bearings. When ordering single bearings, indicate the number of individual bearings required.

Standalone bearings

Standalone bearings are intended for arrangements where only one bearing is used in each bearing position. Although the widths of the bearing rings are made to very tight tolerances, these bearings are not suitable for mounting immediately adjacent to each other.

Table 5

Example of the ordering possibilities for a three-bearing arrangement

Design criteria	What to order	Bearing series designation	Order example
Bearings can be arranged immediately adjacent to each other in any order and in any orientation.	Three single, universally matchable bearings	70 .. DG../P4A	3 x 7014 CDGA/P4A
Bearings can be arranged immediately adjacent to each other in any order and in any orientation. Improved load sharing is desirable.	A set of three universally matchable bearings	70 .. D/P4ATG..	1 x 7014 CD/P4ATGA
Bearings in a back-to-back and tandem arrangement. Improved load sharing is desirable.	Three bearings in a matched set	70 .. D/P4AT..	1 x 7014 CD/P4ATBTA
Bearings in a back-to-back and tandem arrangement. High speed capability with maximum rigidity and improved load sharing is desirable.	Three bearings in a matched set	70 .. E/P4AT..	1 x 7014 CE/P4ATBTA
Bearings in a back-to-back and tandem arrangement. Maximum speed capability with improved load sharing is desirable.	Three bearings in a matched set	70 .. E/P4AT..	1 x 7014 CE/P4ATBTL

Single, universally matchable bearings

Universally matchable bearings are specifically manufactured so that when mounted in random order, but immediately adjacent to each other, preload within a predetermined range and effective load sharing will result without the use of shims or similar devices.

Single, universally matchable bearings are available in different preload classes and are identified by the designation suffix G.

Bearing sets

Sets of super-precision angular contact ball bearings are available as matched bearing sets or as sets of universally matchable bearings. When ordering bearing sets, indicate the number of bearing sets required (the number of individual bearings per set is specified in the designation).

Matched bearing sets

Bearings can be supplied as a complete bearing set consisting of two, three or more bearings. The bearings are matched to each other during production so that when mounted immediately adjacent to each other, in the specified order, preload within a predetermined range and effective load sharing will result without the use of shims or similar devices.

The bore and outside diameters of these bearings are matched to within a maximum of one-third of the permitted diameter tolerance, to provide better load distribution than single universally matchable bearings.

Matched bearing sets are available in different preload classes.

Sets of universally matchable bearings

Bearings in these sets can be mounted in random order for any desired bearing arrangement. The bore and outside diameters of a set of universally matchable bearings are matched to within a maximum of one-third of the permitted diameter tolerance, resulting in better load sharing, when mounted, than single universally matchable bearings.

Sets of universally matchable bearings are available in different preload classes.

Like single, universally matchable bearings, sets of universally matchable bearings are identified by the designation suffix G, but the position of the letter G in the designation is different.

Bearing arrangements

Back-to-back arrangement

In a back-to-back arrangement (→ **fig. 11**), the load lines diverge along the bearing axis. Axial loads acting in both directions can be accommodated, but only by one bearing or bearing set in each direction.

Bearings mounted back-to-back provide a relatively rigid bearing arrangement. The wide span between bearing effective centres makes this arrangement particularly well suited to support moment loads.

Face-to-face arrangement

In a face-to-face arrangement (→ **fig. 12**), the load lines converge along the bearing axis. Axial loads acting in both directions can be accommodated, but only by one bearing or bearing set in each direction.

The short span between effective bearing centres makes face-to-face arrangements less suitable to support moment loads.

Tandem arrangement

The use of a tandem arrangement provides increased axial and radial load carrying capacity compared to a single bearing. In a tandem arrangement (→ **fig. 13**), the load lines are parallel so that radial and axial loads are shared.

The bearing set can only accommodate axial loads acting in one direction. If axial loads act in both directions, or if combined loads are present, additional bearing(s) adjusted against the tandem arrangement must be added.

Fig. 11

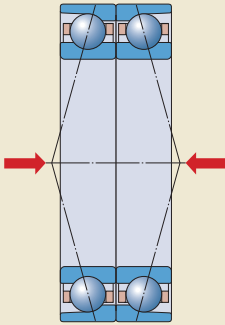

Back-to-back arrangement

Fig. 12

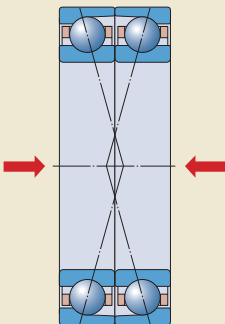

Face-to-face arrangement

Fig. 13

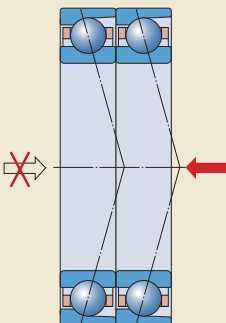

Tandem arrangement

Examples

Universally matchable bearings and matched bearing sets can be arranged in various ways depending on the stiffness and load requirements of the application. The possible arrangements are shown in **fig. 14** (→ **page 144**), including the designation suffixes applicable to matched bearing sets.

Reducing inventories

To decrease inventories and improve parts availability, SKF recommends using universally matchable bearings whenever possible. With universally matchable bearings, a multitude of different bearing sets can be obtained.

Bearing sets with 2 bearings

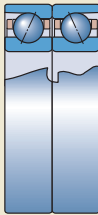

Back-to-back arrangement
Designation suffix DB

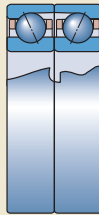

Face-to-face arrangement
Designation suffix DF

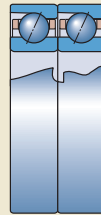

Tandem arrangement
Designation suffix DT

Bearing sets with 3 bearings

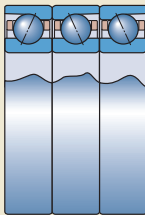

Back-to-back and tandem
arrangement
Designation suffix TBT

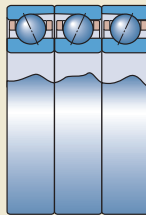

Face-to-face and tandem
arrangement
Designation suffix TFT

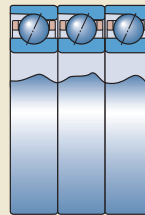

Tandem arrangement
Designation suffix TT

Bearing sets with 4 bearings

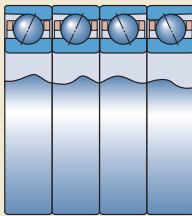

Tandem back-to-back
arrangement
Designation suffix QBC

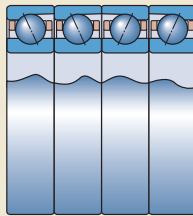

Tandem face-to-face
arrangement
Designation suffix QFC

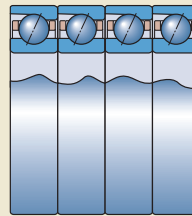

Tandem arrangement
Designation suffix QT

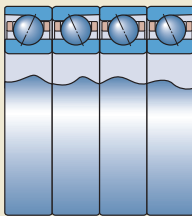

Back-to-back and tandem
arrangement
Designation suffix QBT

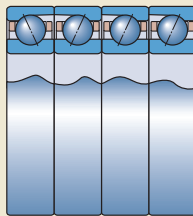

Face-to-face and tandem
arrangement
Designation suffix QFT

Markings on bearings and bearing sets

Each super-precision angular contact ball bearing has various markings on the side faces of the rings (→ **fig. 15**):

- 1 SKF trademark
- 2 Complete designation of the bearing
- 3 Country of manufacture
- 4 Date of manufacture, coded
- 5 Deviation of the mean outside diameter Δ_{Dm} [μm] and position of the maximum eccentricity of the outer ring
- 6 Deviation of the mean bore diameter Δ_{dm} [μm] and position of the maximum eccentricity of the inner ring
- 7 Thrust face mark, punched
- 8 Serial number (bearing sets only)
- 9 "V-shaped" marking (matched bearing sets only)

Sealed bearings are marked in a similar way.

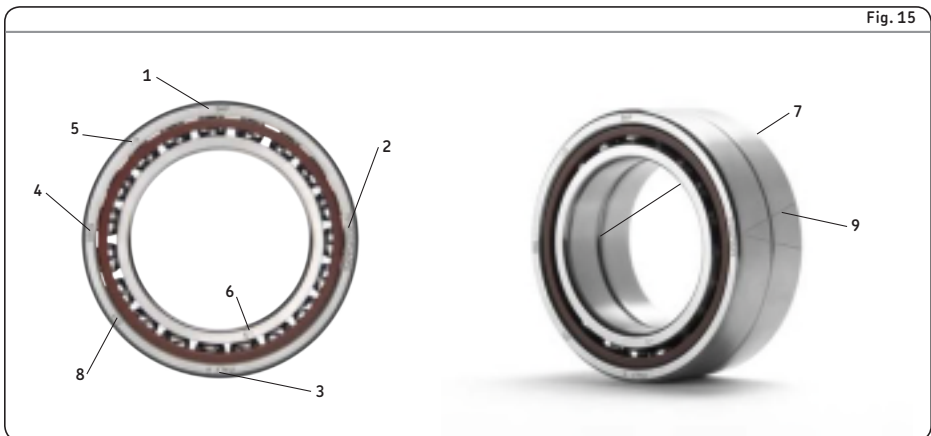

"V-shaped" marking

A "V-shaped" marking on the outside surface of the outer rings of matched bearing sets indicates how the bearings should be mounted to obtain the proper preload in the set.

The marking also indicates how the bearing set should be mounted in relation to the axial load. The "V-shaped" marking should point in the direction that the axial load acts on the inner ring (→ **fig. 16**). In applications where there are axial loads in both directions, the "V-shaped" marking should point in the direction of the heavier of the two loads.

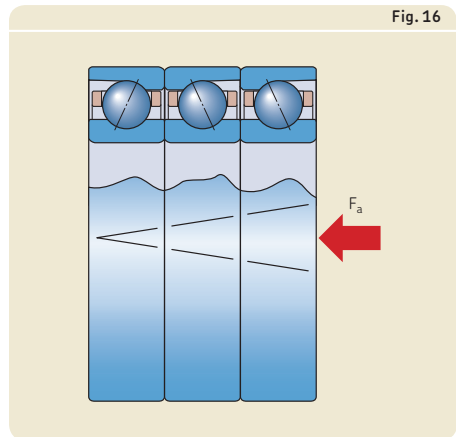

Bearing data

Boundary dimensions

ISO 15

Chamfer dimensions

Minimum values for the chamfer dimensions in the radial direction (r_1, r_3) and axial direction (r_2, r_4) are listed in the product tables (→ **page 198**). The specifications differ according to the series.

718 .. D series

- Values for the inner ring and thrust side of the outer ring: ISO 15
- Values for the non-thrust side of the outer ring are not standardized.

719 .. D, 70 .. D and 72 .. D series

- Values for the inner ring and thrust side of the outer ring: ISO 15
- Values for the non-thrust side of the outer ring: ISO 12044, where applicable

719 .. E series

- Values for the non-thrust side of the inner ring ($d \leq 30$ mm), thrust side of the inner ring, and thrust side of the outer ring: ISO 15
- Values for the non-thrust side of the inner ring ($d > 30$ mm): smaller than those in accordance with ISO 15
- Values for the non-thrust side of the outer ring: ISO 12044

70 .. E series

- Values for the inner ring and thrust side of the outer ring: ISO 15
- Values for the non-thrust side of the outer ring: ISO 12044

719 .. B and 70 .. B series

- Values for the inner ring and thrust side of the outer ring: ISO 15
- Values for the non-thrust side of the outer ring: smaller than those in accordance with ISO 15

The appropriate maximum chamfer limits, which are important when dimensioning fillet radii on associated components, are in accordance with ISO 582 and are listed in the product tables.

Tolerances

P4A or P4 class tolerances as standard. PA9A or P2 class tolerances available on request.

The tolerance values are listed for:

- P4A class tolerances (→ **table 6**)
- P4 class tolerances (→ **table 7, page 148**)
- PA9A class tolerances (→ **table 8, page 149**)
- P2 class tolerances (→ **table 9, page 150**)

For additional information (→ **page 47**)

Table 6

Class P4A tolerances

Inner ring		$\Delta_{dmp}^{1)}$		$\Delta_{ds}^{2)}$		V_{dp}	V_{dmp}	Δ_{Bs}		Δ_{B1s}		V_{Bs}	K_{ia}	S_d	S_{ia}
over	incl.	high	low	high	low	max.	max.	high	low	high	low	max.	max.	max.	max.
mm		μm		μm		μm	μm	μm		μm		μm	μm	μm	μm
2,5	10	0	-4	0	-4	1,5	1	0	-40	0	-250	1,5	1,5	1,5	1,5
10	18	0	-4	0	-4	1,5	1	0	-80	0	-250	1,5	1,5	1,5	1,5
18	30	0	-5	0	-5	1,5	1	0	-120	0	-250	1,5	2,5	1,5	2,5
30	50	0	-6	0	-6	1,5	1	0	-120	0	-250	1,5	2,5	1,5	2,5
50	80	0	-7	0	-7	2	1,5	0	-150	0	-250	1,5	2,5	1,5	2,5
80	120	0	-8	0	-8	2,5	1,5	0	-200	0	-380	2,5	2,5	2,5	2,5
120	150	0	-10	0	-10	6	3	0	-250	0	-380	4	4	4	4
150	180	0	-10	0	-10	6	3	0	-250	0	-380	4	6	5	6
180	250	0	-12	0	-12	7	4	0	-300	0	-500	5	7	6	7
250	315	0	-13	0	-13	8	5	0	-350	0	-550	6	8	7	7
315	400	0	-16	0	-16	10	6	0	-400	0	-600	6	9	8	8
Outer ring		$\Delta_{Dmp}^{1)}$		$\Delta_{Ds}^{2)}$		$V_{Dp}^{3)}$	$V_{Dmp}^{3)}$	$\Delta_{Cs}, \Delta_{C1s}$		V_{Cs}	K_{ea}	S_D	S_{ea}		
over	incl.	high	low	high	low	max.	max.			max.	max.	max.	max.		
mm		μm		μm		μm	μm			μm	μm	μm	μm		
10	18	0	-4	0	-4	1,5	1	Values are identical to those for the inner ring of the same bearing ($\Delta_{Bs}, \Delta_{B1s}$).		1,5	1,5	1,5	1,5		
18	30	0	-5	0	-5	2	1,5			1,5	1,5	1,5	1,5		
30	50	0	-6	0	-6	2	1,5			1,5	2,5	1,5	2,5		
50	80	0	-7	0	-7	2	1,5			1,5	4	1,5	4		
80	120	0	-8	0	-8	2,5	1,5			2,5	5	2,5	5		
120	150	0	-9	0	-9	4	1,5			2,5	5	2,5	5		
150	180	0	-10	0	-10	6	3			4	6	4	6		
180	250	0	-11	0	-11	6	4			5	8	5	8		
250	315	0	-13	0	-13	8	5			5	9	6	8		
315	400	0	-15	0	-15	9	6			7	10	8	10		
400	500	0	-20	0	-20	12	8			8	13	10	13		

Tolerance symbols and definitions → table 4, page 48

1) These deviations apply for bearings in the 8 and 9 diameter series only.

2) These deviations apply for bearings in the 0 and 2 diameter series only.

3) For sealed bearings, values refer to the ring before the seals are installed.

Table 7

Class P4 (ABEC 7) tolerances

Inner ring		$\Delta_{dmp}^{(1)}$		$\Delta_{ds}^{(2)}$		V_{dp}	V_{dmp}	Δ_{Bs}		Δ_{B1s}		V_{Bs}	K_{ia}	S_d	S_{ia}
d	incl.	high	low	high	low	max.	max.	high	low	high	low	max.	max.	max.	max.
mm		μm		μm		μm	μm	μm		μm		μm	μm	μm	μm
2,5	10	0	-4	0	-4	4	2	0	-60	0	-250	2,5	2,5	3	3
10	18	0	-4	0	-4	4	2	0	-80	0	-250	2,5	2,5	3	3
18	30	0	-5	0	-5	5	2,5	0	-120	0	-250	2,5	3	4	4
30	50	0	-6	0	-6	6	3	0	-120	0	-250	3	4	4	4
50	80	0	-7	0	-7	7	3,5	0	-150	0	-250	4	4	5	5
80	120	0	-8	0	-8	8	4	0	-200	0	-380	4	5	5	5
120	150	0	-10	0	-10	10	5	0	-250	0	-380	5	6	6	7
150	180	0	-10	0	-10	10	5	0	-250	0	-380	5	6	6	7

Outer ring		$\Delta_{Dmp}^{(1)}$		$\Delta_{Ds}^{(2)}$		$V_{Dp}^{(3)}$	$V_{Dmp}^{(3)}$	$\Delta_{Cs}, \Delta_{C1s}$	V_{Cs}	K_{ea}	S_D	S_{ea}
D	incl.	high	low	high	low	max.	max.		max.	max.	max.	max.
mm		μm		μm		μm	μm		μm	μm	μm	μm
18	30	0	-5	0	-5	5	2,5	Values are identical to those for the inner ring of the same bearing ($\Delta_{Bs}, \Delta_{B1s}$).	2,5	4	4	5
30	50	0	-6	0	-6	6	3		2,5	5	4	5
50	80	0	-7	0	-7	7	3,5		3	5	4	5
80	120	0	-8	0	-8	8	4		4	6	5	6
120	150	0	-9	0	-9	9	5		5	7	5	7
150	180	0	-10	0	-10	10	5		5	8	5	8
180	250	0	-11	0	-11	11	6		7	10	7	10

Tolerance symbols and definitions → table 4, page 48

- 1) These deviations apply for bearings in the 8 and 9 diameter series only.
- 2) These deviations apply for bearings in the 0 and 2 diameter series only.
- 3) For sealed bearings, values refer to the ring before the seals are installed.

Table 8

Class PA9A tolerances

Inner ring		$\Delta_{dmp}^{(1)}$		$\Delta_{ds}^{(2)}$		V_{dp}	V_{dmp}	Δ_{Bs}		Δ_{B1s}		V_{Bs}	K_{ia}	S_d	S_{ia}
over	incl.	high	low	high	low	max.	max.	high	low	high	low	max.	max.	max.	max.
mm		μm		μm		μm	μm	μm		μm		μm	μm	μm	μm
2,5	10	0	-2,5	0	-2,5	1,5	1	0	-40	0	-250	1,5	1,5	1,5	1,5
10	18	0	-2,5	0	-2,5	1,5	1	0	-80	0	-250	1,5	1,5	1,5	1,5
18	30	0	-2,5	0	-2,5	1,5	1	0	-120	0	-250	1,5	2,5	1,5	2,5
30	50	0	-2,5	0	-2,5	1,5	1	0	-120	0	-250	1,5	2,5	1,5	2,5
50	80	0	-4	0	-4	2	1,5	0	-150	0	-250	1,5	2,5	1,5	2,5
80	120	0	-5	0	-5	2,5	1,5	0	-200	0	-380	2,5	2,5	2,5	2,5
120	150	0	-7	0	-7	4	3	0	-250	0	-380	2,5	2,5	2,5	2,5
150	180	0	-7	0	-7	4	3	0	-250	0	-380	4	5	4	5
180	250	0	-8	0	-8	5	4	0	-300	0	-500	5	5	5	5
Outer ring		$\Delta_{Dmp}^{(1)}$		$\Delta_{Ds}^{(2)}$		$V_{Dp}^{(3)}$	$V_{Dmp}^{(3)}$	$\Delta_{Cs}, \Delta_{C1s}$				V_{Cs}	K_{ea}	S_D	S_{ea}
over	incl.	high	low	high	low	max.	max.					max.	max.	max.	max.
mm		μm		μm		μm	μm					μm	μm	μm	μm
10	18	0	-2,5	0	-2,5	1,5	1	Values are identical to those for the inner ring of the same bearing ($\Delta_{Bs}, \Delta_{B1s}$).				1,5	1,5	1,5	1,5
18	30	0	-4	0	-4	2	1,5					1,5	1,5	1,5	
30	50	0	-4	0	-4	2	1,5					1,5	2,5	2,5	
50	80	0	-4	0	-4	2	1,5					1,5	4	1,5	4
80	120	0	-5	0	-5	2,5	1,5					2,5	5	2,5	5
120	150	0	-5	0	-5	2,5	1,5					2,5	5	2,5	5
150	180	0	-7	0	-7	4	3					2,5	5	2,5	5
180	250	0	-8	0	-8	5	4					4	7	4	7
250	315	0	-8	0	-8	5	4					5	7	5	7
315	400	0	-10	0	-10	6	5					7	8	7	8

Tolerance symbols and definitions → table 4, page 48

1) These deviations apply for bearings in the 8 and 9 diameter series only.

2) These deviations apply for bearings in the 0 and 2 diameter series only.

3) For sealed bearings, values refer to the ring before the seals are installed.

Table 9

Class P2 (ABEC 9) tolerances

Inner ring		$\Delta_{dmp}^{1)}$		$\Delta_{ds}^{2)}$		V_{dp}	V_{dmp}	Δ_{Bs}		Δ_{B1s}		V_{Bs}	K_{ia}	S_d	S_{ia}
d	incl.	high	low	high	low	max.	max.	high	low	high	low	max.	max.	max.	max.
mm		μm		μm		μm	μm	μm		μm		μm	μm	μm	μm
2,5	10	0	-2,5	0	-2,5	2,5	1,5	0	-40	0	-250	1,5	1,5	1,5	1,5
10	18	0	-2,5	0	-2,5	2,5	1,5	0	-80	0	-250	1,5	1,5	1,5	1,5
18	30	0	-2,5	0	-2,5	2,5	1,5	0	-120	0	-250	1,5	2,5	1,5	2,5
30	50	0	-2,5	0	-2,5	2,5	1,5	0	-120	0	-250	1,5	2,5	1,5	2,5
50	80	0	-4	0	-4	4	2	0	-150	0	-250	1,5	2,5	1,5	2,5
80	120	0	-5	0	-5	5	2,5	0	-200	0	-380	2,5	2,5	2,5	2,5
120	150	0	-7	0	-7	7	3,5	0	-250	0	-380	2,5	2,5	2,5	2,5
150	180	0	-7	0	-7	7	3,5	0	-250	0	-380	4	5	4	5
Outer ring		$\Delta_{Dmp}^{1)}$		$\Delta_{Ds}^{2)}$		V_{Dp}	V_{Dmp}	$\Delta_{Cs}, \Delta_{C1s}$		V_{Cs}	K_{ea}	S_D	S_{ea}		
D	incl.	high	low	high	low	max.	max.			max.	max.	max.	max.		
mm		μm		μm		μm	μm			μm	μm	μm	μm		
18	30	0	-4	0	-4	4	2	Values are identical to those for the inner ring of the same bearing ($\Delta_{Bs}, \Delta_{B1s}$).		1,5	2,5	1,5	2,5		
30	50	0	-4	0	-4	4	2			1,5	2,5	1,5	2,5		
50	80	0	-4	0	-4	4	2			1,5	4	1,5	4		
80	120	0	-5	0	-5	5	2,5		2,5	5	2,5	5			
120	150	0	-5	0	-5	5	2,5		2,5	5	2,5	5			
150	180	0	-7	0	-7	7	3,5		2,5	5	2,5	5			
180	250	0	-8	0	-8	8	4		4	7	4	7			

Tolerance symbols and definitions → table 4, page 48

1) These deviations apply for bearings in the 8 and 9 diameter series only.

2) These deviations apply for bearings in the 0 and 2 diameter series only.

Preload

A single super-precision angular contact ball bearing cannot be preloaded until a second bearing provides location in the opposite direction. Detailed information about preload is provided in the sections following.

Bearings manufactured pre-set for preload

Universally matchable bearings and matched bearing sets are manufactured pre-set in different preload classes to meet varying requirements regarding rotational speed, rigidity, and operating temperature.

The amount of preload depends on the bearing series, the contact angle, the internal geometry, and the size of the bearing and applies to bearing sets in back-to-back or face-to-face arrangements. Preload values are not standardized and are listed in the following tables:

- **table 10 (→ page 153)** for bearings in the 718 .. D series
- **table 11 (→ page 154)** for bearings in the 719 .. D and 70 .. D series
- **table 12 (→ page 156)** for bearings in the 719 .. E and 70 .. E series
- **table 13 (→ page 158)** for bearings in the 719 .. B and 70 .. B series
- **table 14 (→ page 160)** for bearings in the 72 .. D series

Matched bearing sets with a special preload can be supplied on request. These bearing sets are identified by the designation suffix G followed by a number. The number is the mean preload value of the set expressed in daN. Special preload is not applicable for sets of universally matchable bearings consisting of three or more bearings. Matched bearing sets consisting of three or more bearings have a heavier preload than sets with two bearings. The preload for these bearing sets is obtained by multiplying the values for a single bearing by a factor listed in **table 15 (→ page 161)**.

719 .. D, 70 .. D and 72 .. D series

Bearings in the 719 .. D, 70 .. D and 72 .. D series are manufactured to four different preload classes:

- class A, extra light preload
- class B, light preload
- class C, moderate preload
- class D, heavy preload

718 .. D, 719 .. E and 70 .. E series

Bearings in the 718 .. D, 719 .. E and 70 .. E series are manufactured to three different preload classes:

- class A, light preload
- class B, moderate preload
- class C, heavy preload

These preload classes are valid for:

- single, universally matchable bearings
- sets of universally matchable bearings
- matched bearing sets

In applications where high speeds take precedence over the degree of rigidity, the following additional preload classes are available:

- class L, reduced light preload for asymmetrical bearing sets
- class M, reduced moderate preload for asymmetrical bearing sets
- class F, reduced heavy preload for asymmetrical bearing sets

As indicated, these preload classes are only available for matched bearing sets that are asymmetrical, e.g. TBT, TFT, QBT, and QFT. Bearing sets in the L, M or F preload class consisting of three or four bearings, have the same preload as sets with two bearings in the A, B or C preload class. Therefore, the preload for matched bearing sets that are asymmetrical, e.g. TBT, TFT, QBT, and QFT, can be obtained directly from the product tables.

An example of the preload possibilities for an arrangement with a matched set of 7014 CE bearings is presented in **table 16 (→ page 161)**.

Angular contact ball bearings

719 .. B and 70 .. B series

Bearings in the 719 .. B and 70 .. B series are manufactured to three different preload classes:

- class A, light preload
- class B, moderate preload
- class C, heavy preload

Table 10

Axial preload of single, universally matchable bearings and matched bearing pairs prior to mounting, arranged back-to-back or face-to-face – 718 .. D series

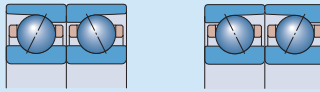

Bore diameter d	Size	Axial preload of bearings in the series ¹⁾					
		718 CD, 718 CD/HC for preload class			718 ACD, 718 ACD/HC for preload class		
		A	B	C	A	B	C
mm	–	N					
10	00	10	30	60	16	48	100
12	01	11	33	66	17	53	105
15	02	12	36	72	19	58	115
17	03	12	37	75	20	60	120
20	04	20	60	120	32	100	200
25	05	22	66	132	35	105	210
30	06	23	70	140	37	110	220
35	07	25	75	150	39	115	230
40	08	26	78	155	40	120	240
45	09	27	80	160	41	125	250
50	10	40	120	240	60	180	360
55	11	55	165	330	87	260	520
60	12	70	210	420	114	340	680
65	13	71	215	430	115	345	690
70	14	73	220	440	117	350	700
75	15	76	225	450	120	360	720
80	16	78	235	470	123	370	740
85	17	115	345	690	183	550	1100
90	18	116	350	700	184	555	1110
95	19	117	355	710	186	560	1120
100	20	120	360	720	190	570	1140
105	21	130	390	780	200	600	1200
110	22	160	500	1000	260	800	1600
120	24	180	550	1100	280	850	1700
130	26	210	620	1230	325	980	1960
140	28	240	720	1440	380	1140	2280
150	30	270	820	1630	430	1300	2590
160	32	280	850	1700	450	1350	2690

¹⁾ The designation suffix HC denotes a hybrid bearing. For additional information, refer to *Hybrid bearings*, page 133.

Axial preload of single, universally matchable bearings and matched bearing pairs prior to mounting, arranged back-to-back or face-to-face – 719 .. D series

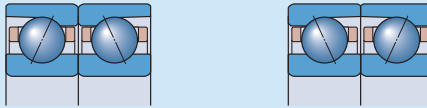

Bore diameter d	Size	Axial preload of bearings in the series ¹⁾ 719 CD, 719 CD/HC for preload class				719 ACD, 719 ACD/HC for preload class			
		A	B	C	D	A	B	C	D
mm	–	N							
10	00	10	20	40	80	15	30	60	120
12	01	10	20	40	80	15	30	60	120
15	02	15	30	60	120	25	50	100	200
17	03	15	30	60	120	25	50	100	200
20	04	25	50	100	200	35	70	140	280
25	05	25	50	100	200	40	80	160	320
30	06	25	50	100	200	40	80	160	320
35	07	35	70	140	280	60	120	240	480
40	08	45	90	180	360	70	140	280	560
45	09	50	100	200	400	80	160	320	640
50	10	50	100	200	400	80	160	320	640
55	11	70	140	280	560	120	240	480	960
60	12	70	140	280	560	120	240	480	960
65	13	80	160	320	640	120	240	480	960
70	14	130	260	520	1 040	200	400	800	1 600
75	15	130	260	520	1 040	210	420	840	1 680
80	16	140	280	560	1 120	220	440	880	1 760
85	17	170	340	680	1 360	270	540	1 080	2 160
90	18	180	360	720	1 440	280	560	1 120	2 240
95	19	190	380	760	1 520	290	580	1 160	2 320
100	20	230	460	920	1 840	360	720	1 440	2 880
105	21	230	460	920	1 840	360	720	1 440	2 880
110	22	230	460	920	1 840	370	740	1 480	2 960
120	24	290	580	1 160	2 320	450	900	1 800	3 600
130	26	350	700	1 400	2 800	540	1 080	2 160	4 320
140	28	360	720	1 440	2 880	560	1 120	2 240	4 480
150	30	470	940	1 880	3 760	740	1 480	2 960	5 920
160	32	490	980	1 960	3 920	800	1 600	3 200	6 400
170	34	500	1 000	2 000	4 000	800	1 600	3 200	6 400
180	36	630	1 260	2 520	5 040	1 000	2 000	4 000	8 000
190	38	640	1 280	2 560	5 120	1 000	2 000	4 000	8 000
200	40	800	1 600	3 200	6 400	1 250	2 500	5 000	10 000
220	44	850	1 700	3 400	6 800	1 300	2 600	5 200	10 400
240	48	860	1 720	3 440	6 880	1 350	2 700	5 400	10 800
260	52	1 050	2 100	4 200	8 400	1 650	3 300	6 600	13 200
280	56	1 090	2 180	4 360	8 720	1 700	3 400	6 800	13 600
300	60	1 400	2 800	5 600	11 200	2 200	4 400	8 800	17 600
320	64	1 400	2 800	5 600	11 200	2 200	4 400	8 800	17 600
340	68	1 460	2 920	5 840	11 680	2 300	4 600	9 200	18 400
360	72	1 460	2 920	5 840	11 680	2 300	4 600	9 200	18 400

¹⁾ The designation suffix HC denotes a hybrid bearing. For additional information, refer to *Hybrid bearings*, page 133.

Table 11b

Axial preload of single, universally matchable bearings and matched bearing pairs prior to mounting, arranged back-to-back or face-to-face – 70 .. D series

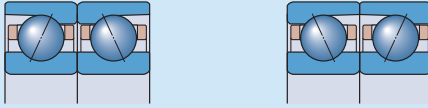

Bore diameter d	Size	Axial preload of bearings in the series ¹⁾							
		70 CD, 70 CD/HC for preload class				70 ACD, 70 ACD/HC for preload class			
		A	B	C	D	A	B	C	D
mm	–	N							
6	6	7	13	25	50	12	25	50	100
7	7	9	18	35	70	15	30	60	120
8	8	11	22	45	90	20	40	80	160
9	9	12	25	50	100	22	45	90	180
10	00	15	30	60	120	25	50	100	200
12	01	15	30	60	120	25	50	100	200
15	02	20	40	80	160	30	60	120	240
17	03	25	50	100	200	40	80	160	320
20	04	35	70	140	280	50	100	200	400
25	05	35	70	140	280	60	120	240	480
30	06	50	100	200	400	90	180	360	720
35	07	60	120	240	480	90	180	360	720
40	08	60	120	240	480	100	200	400	800
45	09	110	220	440	880	170	340	680	1360
50	10	110	220	440	880	180	360	720	1440
55	11	150	300	600	1200	230	460	920	1840
60	12	150	300	600	1200	240	480	960	1920
65	13	160	320	640	1280	240	480	960	1920
70	14	200	400	800	1600	300	600	1200	2400
75	15	200	400	800	1600	310	620	1240	2480
80	16	240	480	960	1920	390	780	1560	3120
85	17	250	500	1000	2000	400	800	1600	3200
90	18	300	600	1200	2400	460	920	1840	3680
95	19	310	620	1240	2480	480	960	1920	3840
100	20	310	620	1240	2480	500	1000	2000	4000
105	21	360	720	1440	2880	560	1120	2240	4480
110	22	420	840	1680	3360	650	1300	2600	5200
120	24	430	860	1720	3440	690	1380	2760	5520
130	26	560	1120	2240	4480	900	1800	3600	7200
140	28	570	1140	2280	4560	900	1800	3600	7200
150	30	650	1300	2600	5200	1000	2000	4000	8000
160	32	730	1460	2920	5840	1150	2300	4600	9200
170	34	800	1600	3200	6400	1250	2500	5000	10000
180	36	900	1800	3600	7200	1450	2900	5800	11600
190	38	950	1900	3800	7600	1450	2900	5800	11600
200	40	1100	2200	4400	8800	1750	3500	7000	14000
220	44	1250	2500	5000	10000	2000	4000	8000	16000
240	48	1300	2600	5200	10400	2050	4100	8200	16400
260	52	1550	3100	6200	12400	2480	4960	9920	19840

¹⁾ The designation suffix HC denotes a hybrid bearing. For additional information, refer to *Hybrid bearings*, page 133.

Axial preload of single, universally matchable bearings and matched bearing pairs prior to mounting, arranged back-to-back or face-to-face – 719 .. E series

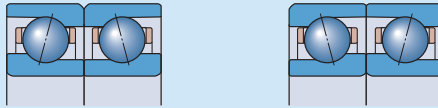

Bore diameter d	Size	Axial preload of bearings in the series ¹⁾					
		719 CE, 719 CE/HC for preload class			719 ACE, 719 ACE/HC for preload class		
		A	B	C	A	B	C
mm	–	N					
8	8	9	27	55	15	46	91
9	09	11	32	64	17	50	100
10	00	11	32	65	17	50	100
12	01	11	34	68	18	55	110
15	02	17	51	102	28	84	170
17	03	18	54	108	29	87	175
20	04	26	79	157	42	130	250
25	05	28	85	170	45	140	270
30	06	30	90	180	48	145	290
35	07	41	125	250	66	200	400
40	08	52	157	315	84	250	505
45	09	55	166	331	88	265	529
50	10	69	210	410	110	330	660
55	11	83	250	500	133	400	800
60	12	87	262	523	139	418	836
65	13	89	266	532	142	425	850
70	14	120	360	710	190	570	1130
75	15	120	361	722	192	577	1150
80	16	123	370	740	195	590	1170
85	17	160	479	957	255	765	1529
90	18	163	488	977	260	780	1560
95	19	166	500	995	265	795	1590
100	20	208	624	1 250	332	996	1 990
110	22	220	650	1 300	340	1 030	2 070
120	24	250	760	1 530	410	1 220	2 440

¹⁾ The designation suffix HC denotes a hybrid bearing. For additional information, refer to *Hybrid bearings*, page 133.

Table 12b

Axial preload of single, universally matchable bearings and matched bearing pairs prior to mounting, arranged back-to-back or face-to-face – 70 .. E series

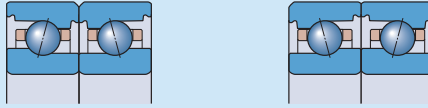

Bore diameter d	Size	Axial preload of bearings in the series ¹⁾					
		70 CE, 70 CE/HC for preload class			70 ACE, 70 ACE/HC for preload class		
		A	B	C	A	B	C
mm	–	N					
6	6	10	25	50	14	41	82
7	7	10	30	60	17	50	100
8	8	15	35	75	20	60	120
9	09	15	40	80	23	65	130
10	00	15	48	95	26	80	160
12	01	17	53	110	28	85	170
15	02	25	70	140	38	115	230
17	03	30	90	185	50	150	300
20	04	40	120	235	64	193	390
25	05	45	130	260	70	210	430
30	06	50	150	300	80	240	480
35	07	60	180	370	100	300	590
40	08	65	200	390	105	310	630
45	09	70	210	410	110	330	660
50	10	85	250	500	130	400	800
55	11	90	270	540	140	430	860
60	12	92	275	550	150	440	870
65	13	110	330	650	170	520	1040
70	14	130	380	760	200	610	1220
75	15	140	420	840	220	670	1340
80	16	180	550	1 090	280	850	1 700
85	17	185	560	1 110	290	890	1 780
90	18	190	580	1 150	300	920	1 840
95	19	230	700	1 400	380	1 130	2 270
100	20	240	720	1 440	390	1 150	2 310
110	22	250	760	1 520	400	1 210	2 420
120	24	310	930	1 850	490	1 480	2 950

¹⁾ The designation suffix HC denotes a hybrid bearing. For additional information, refer to *Hybrid bearings*, page 133.

Axial preload of single, universally matchable bearings and matched bearing pairs prior to mounting, arranged back-to-back or face-to-face – 719 .. B series



Bore diameter d	Size	Axial preload of bearings in the series ¹⁾ 719 CB, 719 CB/HC for preload class			719 ACB, 719 ACB/HC for preload class		
		A	B	C	A	B	C
mm	–	N					
30	06	16	32	96	27	54	160
35	07	17	34	100	29	58	175
40	08	18	36	110	31	62	185
45	09	24	48	145	41	82	245
50	10	26	52	155	43	86	260
55	11	33	66	200	55	110	330
60	12	34	68	205	57	115	340
65	13	35	70	210	60	120	360
70	14	45	90	270	75	150	450
75	15	46	92	275	80	160	480
80	16	52	105	310	87	175	520
85	17	54	110	325	93	185	560
90	18	59	120	355	100	200	600
95	19	60	120	360	105	210	630
100	20	72	145	430	125	250	750
110	22	86	170	515	145	290	870
120	24	90	180	540	155	310	930

¹⁾ The designation suffix HC denotes a hybrid bearing. For additional information, refer to *Hybrid bearings*, page 133.

Table 13b

Axial preload of single, universally matchable bearings and matched bearing pairs prior to mounting, arranged back-to-back or face-to-face – 70 .. B series



Bore diameter d	Size	Axial preload of bearings in the series ¹⁾ 70 CB, 70 CB /HC for preload class			70 ACB, 70 ACB/HC for preload class		
		A	B	C	A	B	C
mm	–	N					
30	06	21	42	125	36	72	215
35	07	23	46	140	38	76	230
40	08	24	48	145	41	82	245
45	09	31	62	185	54	110	330
50	10	33	66	200	56	110	330
55	11	46	92	275	78	155	470
60	12	48	96	290	80	160	480
65	13	49	98	295	85	170	510
70	14	64	130	390	110	220	660
75	15	65	130	390	115	230	690
80	16	78	155	470	150	300	900
85	17	80	160	480	150	300	900
90	18	92	185	550	160	320	960
95	19	94	190	570	165	330	990
100	20	96	190	570	165	330	990
110	22	125	250	750	210	420	1 260
120	24	130	260	780	220	440	1 320

¹⁾ The designation suffix HC denotes a hybrid bearing. For additional information, refer to *Hybrid bearings*, page 133.

Axial preload of single, universally matchable bearings and matched bearing pairs prior to mounting, arranged back-to-back or face-to-face – 72 .. D series

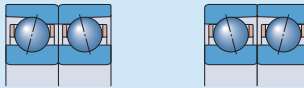

Bore diameter d	Size	Axial preload of bearings in the series ¹⁾ 72 CD, 72 CD/HC for preload class							
		A	B	C	D	72 ACD, 72 ACD/HC for preload class			
mm	–	N							
7	7	12	24	48	96	18	36	72	144
8	8	14	28	56	112	22	44	88	176
9	9	15	30	60	120	25	50	100	200
10	00	17	34	68	136	27	54	108	216
12	01	22	44	88	176	35	70	140	280
15	02	30	60	120	240	45	90	180	360
17	03	35	70	140	280	60	120	240	480
20	04	45	90	180	360	70	140	280	560
25	05	50	100	200	400	80	160	320	640
30	06	90	180	360	720	150	300	600	1200
35	07	120	240	480	960	190	380	760	1520
40	08	125	250	500	1000	200	400	800	1600
45	09	160	320	640	1280	260	520	1040	2080
50	10	170	340	680	1360	265	530	1060	2120
55	11	210	420	840	1680	330	660	1320	2640
60	12	215	430	860	1720	350	700	1400	2800
65	13	250	500	1000	2000	400	800	1600	3200
70	14	260	520	1040	2080	420	840	1680	3360
75	15	270	540	1080	2160	430	860	1720	3440
80	16	320	640	1280	2560	520	1040	2080	4160
85	17	370	740	1480	2960	600	1200	2400	4800
90	18	480	960	1920	3840	750	1500	3000	6000
95	19	520	1040	2080	4160	850	1700	3400	6800
100	20	590	1180	2360	4720	950	1900	3800	7600
105	21	650	1300	2600	5200	1000	2000	4000	8000
110	22	670	1340	2680	5360	1050	2100	4200	8400
120	24	750	1500	3000	6000	1200	2400	4800	9600
130	26	810	1620	3240	6480	1300	2600	5200	10400
140	28	850	1700	3400	6800	1350	2700	5400	10800

¹⁾ The designation suffix HC denotes a hybrid bearing. For additional information, refer to *Hybrid bearings*, page 133.

Table 15

Factors for calculating the preload of a bearing set

Number of bearings	Arrangement	Designation suffix	Factor for preload class	
			A, B, C and D	L, M and F
3	Back-to-back and tandem	TBT	1,35	1
	Face-to-face and tandem	TFT	1,35	1
4	Back-to-back and tandem	QBT	1,6	1
	Face-to-face and tandem	QFT	1,6	1
	Tandem back-to-back	QBC	2	2
	Tandem face-to-face	QFC	2	2
5	Back-to-back and tandem	PBT	1,75	1
	Face-to-face and tandem	PFT	1,75	1
	Tandem back-to-back	PBC	2,45	2
	Tandem face-to-face	PFC	2,45	2

2

Table 16

Example of the (light) preload possibilities for an arrangement with a matched set of 7014 CE bearings

Number of bearings	Arrangement	Preload of a matched set, prior to mounting			
		Designation suffix	Preload	Designation suffix	Preload
–	–	–	N	–	N
2	Back-to-back	DBA	130	–	–
	Face-to-face	DFA	130	–	–
3	Back-to-back and tandem	TBTA	175,5	TBTL	130
	Face-to-face and tandem	TFTA	175,5	TFTL	130
4	Tandem back-to-back	QBCA	260	–	–
	Tandem face-to-face	QFCA	260	–	–
	Back-to-back and tandem	QBTA	208	QBTL	130
	Face-to-face and tandem	QFTA	208	QFTL	130

For symmetrical arrangements, preload class A = preload class L e. g. the designation suffix DBL does not exist.
For bearing sets with five bearings, contact the SKF application engineering service.

Preload in mounted bearing sets

After mounting, sets of universally matchable bearings and matched bearing sets can have a heavier preload than the pre-set preload, pre-determined during manufacture. The increase in preload depends mainly on the actual tolerances for the shaft and housing seats and whether these result in an interference fit with the bearing rings.

An increase in preload can also be caused by deviations from the geometrical form of associated components, such as cylindricity, perpendicularity or concentricity of the bearing seats.

During operation, an additional increase in preload can also be caused by:

- the centrifugal force caused by the rotational speed of the shaft, for constant position arrangements
- a temperature difference between the inner ring, outer ring, and balls
- different coefficient of thermal expansion for the shaft and housing materials compared to bearing steel

If the bearings are mounted with zero interference on a steel shaft and in a thick-walled steel or cast iron housing, preload can be determined with sufficient accuracy from

$$G_m = f f_1 f_2 f_{HC} G_{A,B,C,D}$$

where

G_m = preload in the mounted bearing set [N]

$G_{A,B,C,D}$ = pre-set preload in the bearing set, prior to mounting [N] (→ tables 10 to 14, pages 153 to 160)

f = bearing factor dependent on the bearing series and size (→ table 17)

f_1 = correction factor dependent on the contact angle (→ table 18, page 164)

f_2 = correction factor dependent on the preload class (→ table 18)

f_{HC} = correction factor for hybrid bearings (→ table 18)

Considerably tighter fits may be necessary, for example, for very high speed spindles, where centrifugal forces can loosen the inner ring fit on its shaft seat. These bearing arrangements

must be carefully evaluated. In these cases, contact the SKF application engineering service.

Calculation example

What is the preload in a matched bearing set 71924 CD/P4ADBC after mounting?

The pre-set preload for the set of two bearings in the 719 CD series, prior to mounting, preload class C, size 24 is $G_C = 1\,160\text{ N}$ (→ table 11, page 154).

With the bearing factor $f = 1,26$ (→ table 17) and correction factors $f_1 = 1$ and $f_2 = 1,09$ (→ table 18, page 164), the preload of the mounted bearing set is

$$\begin{aligned} G_m &= f f_1 f_2 G_C \\ &= 1,26 \times 1 \times 1,09 \times 1\,160 \\ &\approx 1\,590\text{ N} \end{aligned}$$

Table 17

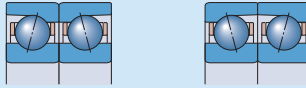
Bearing factor f for calculating the preload in mounted bearing sets

Bore diameter d mm	Size	Bearing factor of bearings in the series							
		718..D	719..D	719..E	719..B	70..D	70..E	70..B	72..D
6	6	-	-	-	-	1,01	1,02	-	-
7	7	-	-	-	-	1,02	1,02	-	1,02
8	8	-	-	1,02	-	1,02	1,02	-	1,02
9	9	-	-	1,03	-	1,03	1,02	-	1,02
10	00	1,05	1,03	1,03	-	1,03	1,03	-	1,02
12	01	1,06	1,04	1,04	-	1,03	1,02	-	1,02
15	02	1,08	1,05	1,04	-	1,03	1,03	-	1,03
17	03	1,1	1,05	1,05	-	1,04	1,04	-	1,03
20	04	1,08	1,05	1,04	-	1,03	1,04	-	1,03
25	05	1,11	1,07	1,06	-	1,05	1,05	-	1,03
30	06	1,14	1,08	1,08	1,07	1,06	1,05	1,03	1,05
35	07	1,18	1,1	1,05	1,06	1,06	1,06	1,04	1,05
40	08	1,23	1,09	1,05	1,06	1,06	1,06	1,04	1,05
45	09	1,24	1,11	1,09	1,08	1,09	1,06	1,05	1,07
50	10	1,3	1,13	1,15	1,09	1,11	1,08	1,06	1,08
55	11	1,27	1,15	1,16	1,09	1,1	1,07	1,06	1,08
60	12	1,3	1,17	1,13	1,11	1,12	1,08	1,06	1,07
65	13	1,28	1,2	1,19	1,13	1,13	1,09	1,07	1,07
70	14	1,32	1,19	1,14	1,1	1,12	1,09	1,07	1,08
75	15	1,36	1,21	1,16	1,11	1,14	1,1	1,08	1,08
80	16	1,41	1,24	1,19	1,13	1,13	1,1	1,07	1,09
85	17	1,31	1,2	1,16	1,11	1,15	1,11	1,08	1,08
90	18	1,33	1,23	1,19	1,12	1,14	1,1	1,07	1,09
95	19	1,36	1,26	1,18	1,13	1,15	1,11	1,07	1,09
100	20	1,4	1,23	1,18	1,11	1,16	1,12	1,08	1,09
105	21	1,44	1,25	-	-	1,15	-	-	1,08
110	22	1,34	1,26	1,2	1,14	1,14	1,1	1,07	1,08
120	24	1,41	1,26	1,18	1,13	1,17	1,12	1,08	1,08
130	26	1,34	1,25	-	-	1,15	-	-	1,09
140	28	1,43	1,29	-	-	1,16	-	-	1,09
150	30	1,37	1,24	-	-	1,16	-	-	-
160	32	1,42	1,27	-	-	1,16	-	-	-
170	34	-	1,3	-	-	1,14	-	-	-
180	36	-	1,25	-	-	1,13	-	-	-
190	38	-	1,27	-	-	1,14	-	-	-
200	40	-	1,23	-	-	1,14	-	-	-
220	44	-	1,28	-	-	1,13	-	-	-
240	48	-	1,32	-	-	1,15	-	-	-
260	52	-	1,24	-	-	1,13	-	-	-
280	56	-	1,27	-	-	-	-	-	-
300	60	-	1,22	-	-	-	-	-	-
320	64	-	1,24	-	-	-	-	-	-
340	68	-	1,27	-	-	-	-	-	-
360	72	-	1,29	-	-	-	-	-	-

Correction factors for preload calculation in mounted bearing sets

Bearing series	Correction factors					f_{HC}
	f_1	f_2 for preload class A	B	C	D	
718 CD	1	1	1,09	1,16	–	1
718 ACD	0,97	1	1,08	1,15	–	1
718 CD/HC	1	1	1,1	1,18	–	1,02
718 ACD/HC	0,97	1	1,09	1,17	–	1,02
719 CD	1	1	1,04	1,09	1,15	1
719 ACD	0,98	1	1,04	1,08	1,14	1
719 CD/HC	1	1	1,07	1,12	1,18	1,04
719 ACD/HC	0,98	1	1,07	1,12	1,17	1,04
719 CE	1	1	1,04	1,08	–	1
719 ACE	0,99	1	1,04	1,07	–	1
719 CE/HC	1	1	1,05	1,09	–	1,01
719 ACE/HC	0,98	1	1,04	1,08	–	1,01
719 CB	1	1	1,02	1,07	–	1
719 ACB	0,99	1	1,02	1,07	–	1
719 CB/HC	1	1	1,03	1,08	–	1,01
719 ACB/HC	0,99	1	1,02	1,08	–	1,01
70 CD	1	1	1,02	1,05	1,09	1
70 ACD	0,99	1	1,02	1,05	1,08	1
70 CD/HC	1	1	1,02	1,05	1,09	1,02
70 ACD/HC	0,99	1	1,02	1,05	1,08	1,02
70 CE	1	1	1,03	1,05	–	1
70 ACE	0,99	1	1,03	1,06	–	1
70 CE/HC	1	1	1,03	1,05	–	1,01
70 ACE/HC	0,99	1	1,03	1,06	–	1,01
70 CB	1	1	1,02	1,05	–	1
70 ACB	0,99	1	1,01	1,04	–	1
70 CB/HC	1	1	1,02	1,05	–	1,01
70 ACB/HC	0,99	1	1,02	1,05	–	1,01
72 CD	1	1	1,01	1,03	1,05	1
72 ACD	0,99	1	1,01	1,02	1,05	1
72 CD/HC	1	1	1,01	1,03	1,06	1,01
72 ACD/HC	0,99	1	1,01	1,03	1,06	1,01

The designation suffix HC denotes a hybrid bearing. For additional information, refer to *Hybrid bearings*, page 133.

Preload with a constant force

In precision, high-speed applications, a constant, uniform preload is important. To maintain the proper preload, calibrated linear springs are typically used between the bearing outer ring and housing shoulder (→ **fig. 17**). With springs, the kinematic behaviour of the bearing does not influence preload under normal operating conditions. However, a spring-loaded bearing arrangement has a lower degree of stiffness than an arrangement using axial displacement to set the preload. The spring preload method is standard for spindles used on internal grinders.

Guideline values for the most common spring-loaded bearing arrangements are listed in **table 19**. The values apply to single CE and ACE design bearings. For bearings in tandem arrangements, the values should be multiplied by a factor equal to the number of bearings preloaded with the spring force. The specified spring preload forces are a compromise between minimal difference in operating contact angle at the inner and outer ring raceways, and axial rigidity at high rotational speeds. Heavier preloads lead to higher operating temperatures.

For additional information, contact the SKF application engineering service.

Fig. 17

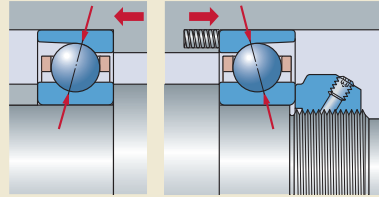

Table 19

Guideline values for spring preload forces for bearings in the 70 .. E series

Bore diameter d	Size	Preload ¹⁾	
		CE design	ACE design
mm	–	N	
6	6	50	80
7	7	60	100
8	8	70	120
9	9	80	130
10	00	90	140
12	01	90	150
15	02	120	200
17	03	160	250
20	04	200	320
25	05	220	350
30	06	240	400
35	07	300	480
40	08	320	500
45	09	340	540
50	10	400	650
55	11	420	700
60	12	450	700
65	13	520	840
70	14	600	1 000
75	15	700	1 100
80	16	900	1 400
85	17	900	1 400
90	18	900	1 500
95	19	1 200	1 900
100	20	1 200	1 900
110	22	1 200	2 000
120	24	1 500	2 400

¹⁾ For single bearings in the CE and ACE designs. For tandem bearing arrangements, the values should be multiplied by a factor equal to the number of bearings.

Preload by axial displacement

For machining centres, milling machines, lathes, and drills, rigidity and precise axial guidance are critical parameters, especially when alternating axial loads occur. For these applications, the preload in the bearings is usually obtained by adjusting the bearing rings relative to each other in the axial direction.

This preload method offers significant advantages in terms of system rigidity. However, depending on the bearing internal design and ball material, preload increases considerably with rotational speed as a result of centrifugal forces.

Universally matchable bearings or matched bearing sets are manufactured so that when mounted properly, they attain their predetermined axial displacement and proper preload values (→ **fig. 18**). With single bearings, precision matched spacer rings must be used.

Individual adjustment of preload

In cases where universally matchable bearings or matched bearing sets are used, preload is determined at the factory during production. In some cases, however, it may be necessary to optimize the preload to accommodate the particular operating conditions. In these cases, the bearings should not be modified, as this requires special tools and knowledge, and the bearings could be damaged irreparably. Bearing modification should be entrusted exclusively to SKF Spindle Service Centres (→ skf.com).

It is possible, however, to increase or decrease preload by using spacer rings between two bearings arranged back-to-back or face-to-face, when used in sets of two or more bearings. There is no requirement to insert spacers between bearings arranged in tandem.

By grinding the side face of the inner or outer spacer, the preload in the bearing set can be changed.

Table 20 provides information about which of the equal-width spacer ring side faces must be ground and what effect it has. The necessary dimensional deviation for the overall width of the spacer rings is listed in the following tables:

- **table 21** (→ **page 168**) for bearings in the 718 .. D series
- **table 22** (→ **page 169**) for bearings in the 719 .. D and 70 .. D series
- **table 23** (→ **page 170**) for bearings in the 719 .. E and 70 .. E series
- **table 24** (→ **page 171**) for bearings in the 719 .. B and 70 .. B series
- **table 25** (→ **page 172**) for bearings in the 72 .. D series

Fig. 18

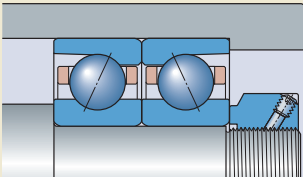

Table 20

Guidelines for spacer ring modification

Preload change of a bearing set	Width reduction Value	Requisite spacer ring between bearings arranged	
		back-to-back	face-to-face
Increasing the preload			
from A to B	a	inner	outer
from B to C	b	inner	outer
from C to D	c	inner	outer
from A to C	a + b	inner	outer
from A to D	a + b + c	inner	outer
Decreasing the preload			
from B to A	a	outer	inner
from C to B	b	outer	inner
from D to C	c	outer	inner
from C to A	a + b	outer	inner
from D to A	a + b + c	outer	inner

Spacer rings

As a rule, using spacer rings with angular contact ball bearing sets is advantageous when:

- preload in the bearing set needs to be adjusted
- moment stiffness and moment load capacity should be increased
- nozzles for oil lubrication must be as close as possible to the bearing raceways
- sufficiently large space is needed for surplus grease, in order to reduce frictional heat in the bearing
- improved heat dissipation via the housing is required at very high operating speeds

To achieve optimum bearing performance, spacer rings must not deform under load, otherwise form deviations can influence the preload in the bearing set. As a result, the guideline values for the shaft and housing tolerances should always be used.

Spacer rings should be made of high-grade steel that can be hardened to between 45 and 60 HRC, depending on the application. Plane parallelism of the face surfaces is particularly important. The permissible deviation must not exceed 1 to 2 μm .

Unless preload is to be adjusted, the overall width of the inner and outer spacer rings should be identical. The most accurate way to do this is to process the width of the concentric inner and outer spacer rings in one operation.

Effect of rotational speed on preload

Using strain gauges, SKF has determined that preload changes with rotational speed and that there is a marked increase in preload at very high rotational speeds. This is mainly attributable to the heavy centrifugal forces on the balls causing them to change their position in the raceways.

When compared to a bearing with steel balls, a hybrid bearing (bearing with ceramic balls) can attain much higher rotational speeds, without significantly increasing preload, as a result of the lower mass of the balls.

Guideline values for spacer ring width reduction – 718 .. D series

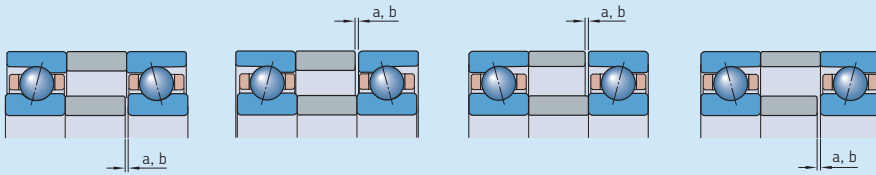

Increasing the preload
(back-to-back)

Decreasing the preload
(back-to-back)

Increasing the preload
(face-to-face)

Decreasing the preload
(face-to-face)

Bore diameter d	Size	Requisite spacer ring width reduction of bearings in the series			
		718 CD		718 ACD	
mm	–	a	b	a	b
		µm			
10	00	5	5	4	4
12	01	5	5	4	4
15	02	5	5	4	4
17	03	5	5	4	4
20	04	6	6	4	5
25	05	6	6	4	5
30	06	6	6	4	5
35	07	6	6	4	5
40	08	6	6	4	5
45	09	6	6	4	5
50	10	8	8	5	6
55	11	9	9	6	7
60	12	10	11	7	8
65	13	10	11	7	8
70	14	10	11	7	8
75	15	10	11	7	8
80	16	10	11	7	8
85	17	13	13	9	10
90	18	13	14	9	10
95	19	13	14	9	10
100	20	13	14	9	10
105	21	14	14	9	10
110	22	16	16	10	12
120	24	16	17	11	12
130	26	16	17	11	12
140	28	18	20	12	14
150	30	19	20	13	14
160	32	19	20	13	15

Table 22

Guideline values for spacer ring width reduction – 719 .. D and 70 .. D series

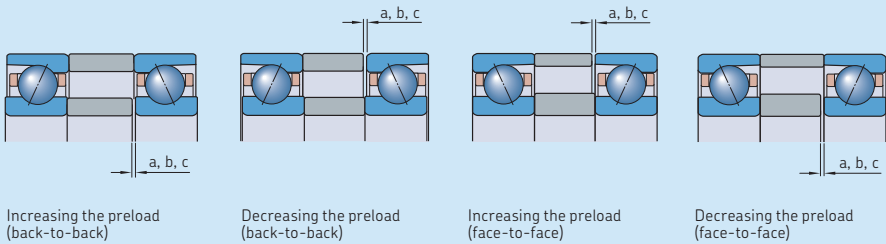

Bore diameter d	Size	Requisite spacer ring width reduction of bearings in the series											
		719 CD			719 ACD			70 CD			70 ACD		
mm	–	a	b	c	a	b	c	a	b	c	a	b	c
		μm											
6	6	–	–	–	–	–	–	3	4	7	2	4	5
7	7	–	–	–	–	–	–	4	5	8	2	4	6
8	8	–	–	–	–	–	–	4	6	8	3	4	6
9	9	–	–	–	–	–	–	4	6	8	3	4	6
10	00	3	4	6	2	3	5	4	6	9	3	4	7
12	01	3	4	6	2	3	5	4	6	9	3	4	7
15	02	4	5	8	2	4	6	4	6	9	3	4	7
17	03	4	5	8	2	4	6	5	7	10	3	5	7
20	04	4	6	9	3	4	6	6	8	12	3	5	8
25	05	4	6	9	3	4	6	6	8	12	3	5	8
30	06	4	6	9	3	4	6	6	9	14	4	7	10
35	07	4	7	10	3	5	7	6	10	14	4	7	10
40	08	5	7	11	3	5	8	6	10	14	4	7	10
45	09	5	8	11	3	5	8	8	11	16	5	8	12
50	10	5	8	11	3	5	8	8	11	16	5	8	12
55	11	6	9	14	4	7	10	9	13	19	6	9	14
60	12	6	9	14	4	7	10	9	13	19	6	9	14
65	13	6	10	15	4	7	10	9	13	19	6	9	14
70	14	7	11	16	5	8	12	10	15	22	6	10	16
75	15	7	11	16	5	8	12	10	15	22	6	10	16
80	16	7	11	17	5	8	12	11	16	23	7	11	17
85	17	8	13	19	6	9	14	11	16	24	7	11	17
90	18	9	13	19	6	9	14	12	18	26	8	12	19
95	19	9	13	20	6	9	14	12	18	26	8	12	19
100	20	10	15	22	6	10	16	12	18	26	8	12	19
105	21	10	15	22	6	10	16	13	19	29	8	13	21
110	22	10	15	22	6	10	16	14	21	31	9	15	23
120	24	11	16	24	7	11	18	14	21	31	9	15	23
130	26	12	18	27	8	12	19	16	24	35	11	17	26
140	28	12	18	27	8	12	20	16	24	36	11	17	26
150	30	14	21	32	9	15	23	17	26	38	11	17	27
160	32	14	22	32	9	15	24	18	27	40	12	19	29
170	34	14	22	33	9	15	24	18	28	41	12	19	29
180	36	16	24	36	10	17	27	20	30	44	13	20	32
190	38	16	25	37	10	17	27	20	30	45	13	20	32
200	40	18	28	41	12	19	30	22	33	49	14	22	35
220	44	18	28	42	12	19	30	23	35	52	15	24	37
240	48	18	28	42	12	20	31	23	35	53	15	24	38
260	52	19	30	45	13	21	33	25	39	58	16	26	41
280	56	19	30	45	13	21	34	–	–	–	–	–	–
300	60	23	36	54	15	24	38	–	–	–	–	–	–
320	64	23	36	54	15	24	38	–	–	–	–	–	–
340	68	23	36	54	15	24	39	–	–	–	–	–	–
360	72	23	36	54	15	24	39	–	–	–	–	–	–

Guideline values for spacer ring width reduction – 719 .. E and 70 .. E series

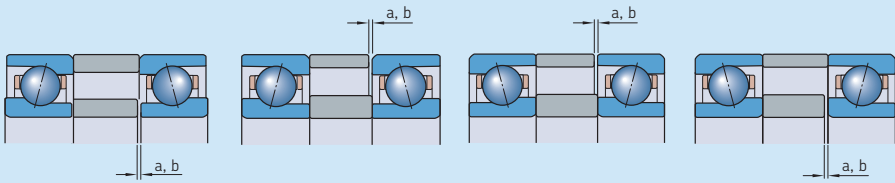

Increasing the preload (back-to-back)

Decreasing the preload (back-to-back)

Increasing the preload (face-to-face)

Decreasing the preload (face-to-face)

Bore diameter d	Size	Requisite spacer ring width reduction of bearings in the series ¹⁾							
		719 CE		719 ACE		70 CE		70 ACE	
mm	–	a	b	a	b	a	b	a	b
		μm							
6	6	–	–	–	–	6	7	5	5
7	7	–	–	–	–	8	8	5	6
8	8	7	8	5	5	8	10	6	6
9	9	7	8	5	5	8	10	6	6
10	00	7	8	5	5	9	10	6	6
12	01	7	8	5	5	9	10	6	6
15	02	8	9	6	6	9	10	6	11
17	03	9	9	6	6	11	12	7	11
20	04	10	10	7	7	13	13	8	11
25	05	10	10	7	7	13	13	8	11
30	06	10	10	7	7	13	13	8	11
35	07	11	11	7	8	13	15	9	11
40	08	12	13	8	9	13	15	9	11
45	09	12	13	8	9	13	15	9	11
50	10	14	14	9	10	14	15	9	11
55	11	15	16	9	11	14	15	9	11
60	12	15	16	9	11	14	15	9	11
65	13	15	16	9	11	15	16	10	11
70	14	17	19	11	12	16	17	10	11
75	15	17	19	11	13	16	17	10	11
80	16	17	19	11	13	18	19	12	13
85	17	20	22	13	14	18	19	12	13
90	18	20	22	13	14	18	19	12	13
95	19	20	22	13	15	20	22	13	15
100	20	22	25	14	16	20	22	13	15
110	22	22	25	14	16	20	22	13	15
120	24	25	28	16	18	22	24	14	16

¹⁾ Data for bearings with an 18° contact angle is available on request.

Table 24

Guideline values for spacer ring width reduction – 719 .. B and 70 .. B series

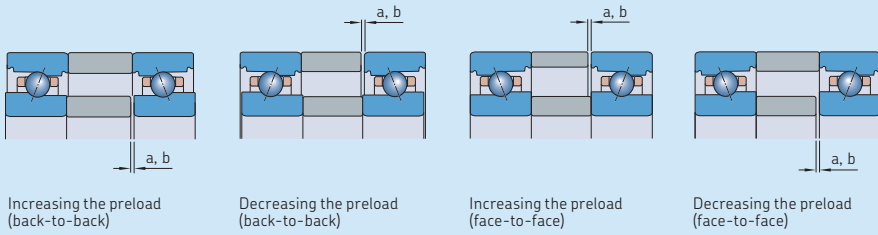

Bore diameter d	Size	Requisite spacer ring width reduction of bearings in the series ¹⁾							
		719 CB		719 ACB		70 CB		70 ACB	
mm	–	a	b	a	b	a	b	a	b
		μm							
30	06	3	8	2	6	3	10	2	7
35	07	3	8	2	6	3	10	2	7
40	08	3	8	2	6	3	10	2	7
45	09	3	9	2	6	4	10	3	7
50	10	3	9	2	6	4	11	3	7
55	11	4	11	2	7	4	12	3	9
60	12	4	11	2	7	4	13	3	9
65	13	4	11	2	7	5	13	3	9
70	14	4	12	3	8	5	15	3	10
75	15	4	12	3	8	5	15	3	10
80	16	4	12	3	8	6	16	4	12
85	17	4	12	3	8	6	16	4	12
90	18	5	13	3	9	7	18	4	13
95	19	5	13	3	9	7	18	4	13
100	20	5	14	3	9	7	18	4	13
110	22	5	16	4	10	7	19	4	13
120	24	5	16	4	10	7	19	4	13

¹⁾ Data for bearings with an 18° contact angle is available on request.

Guideline values for spacer ring width reduction – 72 .. D series

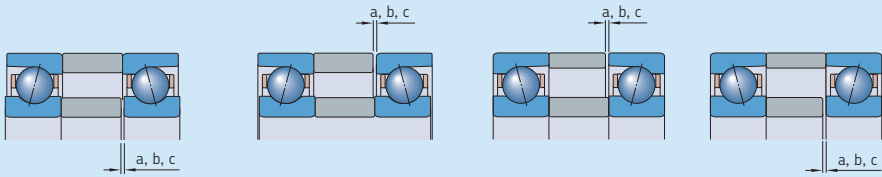

Increasing the preload
(back-to-back)

Decreasing the preload
(back-to-back)

Increasing the preload
(face-to-face)

Decreasing the preload
(face-to-face)

Bore diameter d	Size	Requisite spacer ring width reduction of bearings in the series					
		72 CD			72 ACD		
mm	–	a	b	c	a	b	c
		μm					
7	7	4	5	8	2	4	6
8	8	4	6	9	3	4	7
9	9	4	6	9	3	4	7
10	00	4	6	9	3	4	7
12	01	5	7	10	3	5	7
15	02	6	8	12	4	5	8
17	03	6	9	13	4	6	10
20	04	6	10	14	4	6	10
25	05	6	10	14	4	6	10
30	06	8	11	16	5	8	12
35	07	9	13	19	6	9	14
40	08	9	13	19	6	9	14
45	09	10	15	21	7	10	16
50	10	10	15	21	7	10	16
55	11	11	16	24	7	11	18
60	12	11	16	24	7	11	18
65	13	12	18	26	8	13	19
70	14	12	18	26	8	13	19
75	15	12	18	26	8	13	19
80	16	13	19	28	9	14	21
85	17	14	21	30	9	14	22
90	18	16	24	37	11	17	26
95	19	17	26	38	12	18	28
100	20	19	28	40	12	19	30
105	21	19	29	42	13	20	30
110	22	19	29	42	13	20	30
120	24	21	31	45	14	21	33
130	26	21	31	45	14	21	33
140	28	21	31	45	14	21	33

Axial stiffness

Axial stiffness depends on the elastic deformation (deflection) of the bearing under load and can be expressed as a ratio of load to deflection. However, since the relationship between deflection and load is not linear, only guideline values can be provided. The values are listed in the following tables:

- **table 27** (→ **page 174**) for bearings in the 718 .. D series
- **table 28** (→ **page 176**) for bearings in the 719 .. D and 70 .. D series
- **table 29** (→ **page 178**) for bearings in the 719 .. E and 70 .. E series
- **table 30** (→ **page 180**) for bearings in the 719 .. B and 70 .. B series
- **table 31** (→ **page 182**) for bearings in the 72 .. D series

These values apply to bearing pairs mounted with a near zero interference fit on a steel shaft, under static conditions and subjected to moderate loads.

More accurate values for axial stiffness can be calculated using advanced computer methods. For additional information, contact the SKF application engineering service.

Comparing same-size bearings, bearing sets comprising three or more bearings provide a higher degree of axial stiffness than sets with two bearings. The guideline values for axial stiffness for these sets can be calculated by

multiplying the values listed in **tables 27 to 31** by a factor provided in **table 26**.

For hybrid bearings, the guideline values for axial stiffness can be obtained in the same way as for bearings with steel balls. However, the calculated value should then be multiplied by a factor of 1,11 (for all arrangements and preload classes).

Table 26

Factors for calculating the axial stiffness of a bearing set

Number of bearings	Arrangement	Designation suffix	Factor for preload class	
			A, B, C and D	L, M and F
3	Back-to-back and tandem	TBT	1,45	1,25
	Face-to-face and tandem	TFT	1,45	1,25
4	Back-to-back and tandem	QBT	1,8	1,45
	Face-to-face and tandem	QFT	1,8	1,45
	Tandem back-to-back	QBC	2	2
	Tandem face-to-face	QFC	2	2

For bearing sets with five bearings, contact the SKF application engineering service.

Static axial stiffness for two bearings arranged back-to-back or face-to-face – 718 .. D series



Bore diameter d	Size	Static axial stiffness of bearings in the series					
		718 CD for preload class			718 ACD for preload class		
mm	–	A	B	C	A	B	C
		N/μm					
10	00	13	22	32	30	47	65
12	01	15	25	37	34	54	72
15	02	17	30	43	40	63	85
17	03	18	31	45	43	67	90
20	04	22	38	55	52	83	112
25	05	26	44	64	60	95	128
30	06	29	49	72	69	106	144
35	07	32	56	82	76	119	161
40	08	36	61	90	83	130	178
45	09	38	65	95	87	139	189
50	10	47	81	119	107	168	231
55	11	53	91	135	124	195	268
60	12	59	103	152	141	222	306
65	13	61	105	155	144	227	312
70	14	65	112	166	152	241	332
75	15	69	119	177	162	257	355
80	16	74	128	191	171	274	379
85	17	79	137	202	189	296	406
90	18	82	142	210	194	307	420
95	19	85	147	218	200	316	436
100	20	90	156	231	211	335	462
105	21	96	167	250	220	353	488
110	22	99	173	256	236	377	518
120	24	112	196	291	262	417	576
130	26	119	202	296	278	439	603
140	28	130	226	336	306	489	675
150	30	136	236	346	323	512	702
160	32	147	256	379	352	556	764

Static axial stiffness for two bearings arranged back-to-back or face-to-face – 719 .. D series

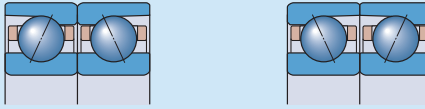

Bore diameter d	Size	Static axial stiffness of bearings in the series							
		719 CD for preload class				719 ACD for preload class			
mm	–	A	B	C	D	A	B	C	D
		N/μm							
10	00	12	16	22	32	29	38	49	65
12	01	13	17	23	33	31	39	52	69
15	02	16	21	29	41	40	51	67	88
17	03	16	22	30	43	42	54	70	93
20	04	22	29	40	56	51	65	85	113
25	05	24	32	44	62	60	78	101	134
30	06	26	35	47	67	65	83	109	145
35	07	32	42	58	82	81	105	137	183
40	08	36	48	66	93	89	115	151	199
45	09	40	53	73	103	100	129	168	225
50	10	43	57	78	110	105	137	180	240
55	11	49	65	89	126	124	161	211	282
60	12	50	67	92	130	128	166	218	292
65	13	56	75	104	148	136	176	232	311
70	14	76	104	147	215	180	235	314	428
75	15	80	110	156	228	194	255	340	464
80	16	85	117	167	246	204	267	358	490
85	17	89	122	172	251	214	281	374	509
90	18	94	129	183	268	224	293	392	536
95	19	101	139	198	291	240	315	420	576
100	20	107	147	209	306	255	336	449	613
105	21	110	151	215	316	263	346	463	633
110	22	113	156	221	325	274	359	482	661
120	24	127	174	246	361	302	396	529	724
130	26	137	188	266	391	325	427	570	780
140	28	146	201	286	420	348	457	614	841
150	30	154	211	297	435	370	485	648	882
160	32	166	227	321	471	402	530	710	970
170	34	171	236	334	493	415	546	731	1002
180	36	183	250	353	516	442	581	774	1055
190	38	189	260	367	538	455	599	798	1090
200	40	202	275	387	565	484	635	845	1148
220	44	224	306	434	635	533	699	934	1275
240	48	237	325	461	678	584	767	1029	1412
260	52	249	339	475	688	616	807	1071	1455
280	56	266	363	509	741	659	867	1154	1572
300	60	272	369	514	741	663	866	1146	1548
320	64	281	380	530	765	683	892	1183	1599
340	68	300	408	571	827	739	967	1284	1742
360	72	309	420	588	853	754	987	1311	1779

Table 28b

Static axial stiffness for two bearings arranged back-to-back or face-to-face – 70 .. D series

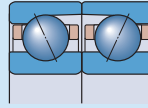
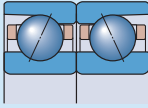

Bore diameter d	Size	Static axial stiffness of bearings in the series				70 ACD for preload class			
		70 CD for preload class A	B	C	D	A	B	C	D
mm	–	N/μm							
6	6	8	10	13	18	19	26	33	44
7	7	9	12	16	22	22	28	37	49
8	8	10	14	19	26	27	35	45	60
9	9	11	15	21	29	30	39	51	67
10	00	13	17	23	33	32	41	54	71
12	01	14	18	25	35	34	44	57	76
15	02	17	23	31	44	41	53	69	92
17	03	19	26	35	50	48	62	81	107
20	04	23	30	42	59	54	69	90	120
25	05	25	33	46	64	64	83	108	143
30	06	30	40	55	77	79	102	133	176
35	07	36	47	64	90	86	110	144	190
40	08	38	51	69	96	96	124	162	214
45	09	56	76	107	155	132	173	229	309
50	10	58	79	111	161	141	184	244	331
55	11	67	91	128	186	159	207	275	372
60	12	70	95	133	193	168	219	291	393
65	13	74	101	143	207	174	227	302	409
70	14	81	111	156	227	191	249	330	447
75	15	84	115	162	235	200	262	347	471
80	16	92	125	175	254	223	291	386	523
85	17	97	132	185	268	233	304	405	549
90	18	103	141	198	287	245	321	425	575
95	19	108	148	208	302	258	337	448	607
100	20	112	153	215	312	270	355	472	640
105	21	117	159	223	324	279	365	484	655
110	22	122	166	232	337	290	379	503	681
120	24	131	179	251	364	318	416	552	749
130	26	145	198	277	400	353	460	610	826
140	28	151	206	289	418	364	477	633	856
150	30	163	221	310	449	388	506	671	909
160	32	171	233	327	472	414	540	717	968
170	34	179	243	339	488	433	563	744	1 003
180	36	186	251	349	501	456	593	782	1 052
190	38	196	266	370	532	471	613	809	1 088
200	40	208	280	389	556	509	660	871	1 170
220	44	222	300	415	592	546	710	935	1 254
240	48	234	316	438	627	571	743	979	1 315
260	52	250	336	464	660	617	801	1 053	1 409

Static axial stiffness for two bearings arranged back-to-back or face-to-face – 719 .. E series

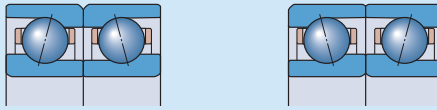

Bore diameter d	Size	Static axial stiffness of bearings in the series					
		719 CE for preload class			719 ACE for preload class		
mm	–	A	B	C	A	B	C
N/μm							
8	8	8	13	18	21	32	41
9	9	10	16	21	25	37	48
10	00	10	16	22	25	37	48
12	01	11	17	23	27	41	53
15	02	13	21	29	34	51	66
17	03	14	23	31	35	55	71
20	04	18	28	39	47	69	88
25	05	20	32	44	51	77	100
30	06	23	35	49	55	85	111
35	07	28	43	59	69	104	136
40	08	32	49	67	78	117	153
45	09	34	53	73	85	127	166
50	10	38	61	83	96	145	190
55	11	42	67	92	105	160	210
60	12	47	73	100	115	173	228
65	13	47	76	105	120	181	238
70	14	52	83	113	131	197	258
75	15	54	86	118	137	205	269
80	16	56	89	123	141	214	281
85	17	63	99	136	157	237	311
90	18	65	102	141	164	247	324
95	19	68	107	147	170	256	338
100	20	73	116	160	187	280	367
110	22	80	126	174	199	301	397
120	24	82	129	179	207	312	411

Table 29b

Static axial stiffness for two bearings arranged back-to-back or face-to-face – 70 .. E series

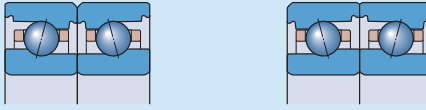

Bore diameter d	Size	Static axial stiffness of bearings in the series					
		70 CE for preload class			70 ACE for preload class		
mm	–	A	B	C	A	B	C
N/μm							
6	6	8	12	16	19	28	37
7	7	8	13	18	21	31	41
8	8	10	14	20	23	34	45
9	9	11	16	22	26	38	50
10	00	12	19	26	31	47	61
12	01	13	21	30	34	50	66
15	02	16	25	34	40	59	66
17	03	18	28	39	46	68	89
20	04	21	32	44	52	78	102
25	05	24	37	50	59	89	117
30	06	28	44	60	71	105	138
35	07	31	49	67	79	119	154
40	08	34	54	73	87	129	169
45	09	38	59	79	94	140	183
50	10	42	65	88	104	156	204
55	11	46	72	98	116	174	226
60	12	48	75	101	122	180	235
65	13	53	83	112	132	198	259
70	14	57	88	120	143	215	280
75	15	65	102	140	161	243	318
80	16	72	114	157	178	268	352
85	17	75	118	163	186	281	369
90	18	79	125	171	196	297	389
95	19	84	133	184	212	319	420
100	20	88	138	191	220	330	435
110	22	94	149	204	237	356	466
120	24	104	164	225	259	391	512

Static axial stiffness for two bearings arranged back-to-back or face-to-face – 719 .. B series



Bore diameter d	Size	Static axial stiffness of bearings in the series 719 CB for preload class			719 ACB for preload class		
		A	B	C	A	B	C
mm	–	N/μm					
30	06	20	27	43	53	68	102
35	07	23	29	47	59	75	114
40	08	25	32	52	65	83	124
45	09	28	37	60	74	95	143
50	10	31	40	65	79	102	155
55	11	34	45	73	88	114	172
60	12	36	48	77	94	122	182
65	13	38	51	81	100	129	195
70	14	44	57	91	112	144	218
75	15	46	60	96	120	155	234
80	16	49	64	103	126	163	246
85	17	52	68	109	136	174	264
90	18	53	70	112	139	178	270
95	19	56	73	117	147	188	286
100	20	60	79	125	157	202	306
110	22	66	87	140	174	221	338
120	24	71	94	150	188	243	366

Table 30b

Static axial stiffness for two bearings arranged back-to-back or face-to-face – 70 .. B series



Bore diameter d	Size	Static axial stiffness of bearings in the series 70 CB for preload class			70 ACB for preload class		
		A	B	C	A	B	C
mm	–	N/μm					
30	06	22	29	46	58	74	111
35	07	25	33	52	64	82	124
40	08	28	36	57	71	92	138
45	09	31	40	64	79	103	157
50	10	33	43	69	87	110	165
55	11	38	50	80	100	128	194
60	12	41	54	86	107	135	204
65	13	41	54	85	107	138	208
70	14	47	63	99	123	159	239
75	15	50	65	104	133	169	255
80	16	52	68	109	144	182	276
85	17	54	71	112	148	188	284
90	18	54	71	112	142	183	275
95	19	56	74	117	147	190	286
100	20	58	76	120	152	194	294
110	22	71	93	147	184	236	355
120	24	75	98	156	197	252	379

Static axial stiffness for two bearings arranged back-to-back or face-to-face – 72 .. D series

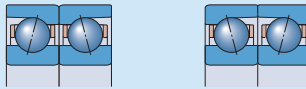

Bore diameter d	Size	Static axial stiffness of bearings in the series								
		72 CD for preload class				72 ACD for preload class				
mm	–	A	B	C	D	A	B	C	D	
N/μm										
7	7	11	15	21	30	27	35	46	61	
8	8	12	15	21	30	28	36	48	63	
9	9	13	17	23	33	32	41	54	71	
10	00	14	19	26	37	35	45	59	78	
12	01	16	22	30	42	41	52	68	90	
15	02	19	26	35	49	46	60	78	102	
17	03	21	28	38	53	53	68	89	118	
20	04	25	33	45	63	61	79	102	135	
25	05	29	38	52	72	71	92	119	158	
30	06	43	59	82	118	105	137	181	244	
35	07	50	67	94	136	119	154	204	275	
40	08	53	71	100	143	127	165	218	294	
45	09	61	82	115	166	146	190	252	341	
50	10	65	88	124	178	154	201	266	359	
55	11	72	98	137	197	172	224	296	399	
60	12	75	102	142	205	182	238	315	424	
65	13	78	106	148	212	189	245	324	437	
70	14	83	112	156	225	201	261	345	464	
75	15	87	118	165	237	211	274	361	487	
80	16	96	130	181	260	257	303	401	540	
85	17	102	139	193	278	250	325	429	578	
90	18	114	154	215	314	273	355	469	632	
95	19	115	156	217	313	280	365	482	649	
100	20	122	165	230	331	296	388	509	685	
105	21	129	174	243	349	308	399	527	708	
110	22	135	183	254	364	325	423	557	748	
120	24	139	188	261	373	338	440	579	777	
130	26	155	209	291	416	378	491	630	869	
140	28	163	220	305	437	397	516	679	911	

Fitting and clamping bearing rings

Super-precision angular contact ball bearings are typically located axially on shafts or in housings with either precision lock nuts (→ **fig. 19**) or end plates. These components require high geometrical precision and good mechanical strength to provide adequate support and location.

The tightening torque M_t , for precision lock nuts or end plate bolts, must be sufficient to keep all components, including the bearings, in place without causing distortions or other damage.

For information about precision lock nuts, refer to *Precision lock nuts* (→ **page 375**).

Fig. 19

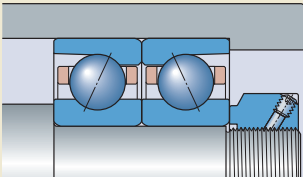

Calculating the required tightening torque

Due to the number of variables (friction between mating components, degree of interference fit, increased preload due to interference fit etc.), it is not possible to accurately calculate the required tightening torque M_t for a precision lock nut or the bolts in an end plate. The following formulae can be used to estimate M_t , but the results should be verified during operation.

The required axial clamping force for a precision lock nut or the bolts in an end plate can be estimated from

$$P_a = F_s + (N_{cp} F_c) + G_{A,B,C,D}$$

The required tightening torque for a precision lock nut can be estimated from

$$M_t = K P_a$$

The required tightening torque for end plate bolts can be estimated from

$$M_t = K \frac{P_a}{N_b}$$

where

- M_t = required tightening torque [Nmm]
- P_a = required axial clamping force [N]
- F_c = axial fitting force [N]
 - for bearings in the 718 .. D, 719 .. D, 70 .. D and 72 .. D series (→ **table 32, page 186**)
 - for bearings in the 719 .. E and 70 .. E series (→ **table 33, page 187**)
 - for bearings in the 719 .. B and 70 .. B series (→ **table 34, page 188**)
- F_s = minimum axial clamping force [N]
 - for bearings in the 718 .. D, 719 .. D, 70 .. D and 72 .. D series (→ **table 32**)
 - for bearings in the 719 .. E and 70 .. E series (→ **table 33**)
 - for bearings in the 719 .. B and 70 .. B series (→ **table 34**)
- $G_{A,B,C,D}$ = pre-set bearing preload, prior to mounting [N] (→ **tables 10 to 14, pages 153 to 160**)
- K = calculation factor dependent on the thread (→ **table 35, page 189**)
- N_{cp} = number of bearings in the same orientation as the bearing that the precision lock nut or end plate is in direct contact with¹⁾
- N_b = number of end plate bolts

¹⁾ This is not the total number of bearings in the arrangement, only those that require to be moved to close gaps between rings to achieve pre-set preload. Refer also to *Locking procedure*.

Locking procedure

When locating super-precision angular contact ball bearings axially using a precision lock nut or end plate, the following procedure should be applied to be sure that all of the bearings are fully seated and the clamping force is re-set to the estimated required level.

- 1 Tighten the lock nut / end plate bolts 2 to 3 times tighter than the value for M_t .
- 2 Loosen the lock nut / end plate bolts.
- 3 Retighten the lock nut / end plate bolts to the value of M_t .

Minimum axial clamping force and axial fitting force for precision lock nuts and end plates for D design bearings

Bore diameter d	Size	Minimum axial clamping force for bearings in the series				Axial fitting force for bearings in the series			
		718 .. D F _s	719 .. D	70 .. D	72 .. D	718 .. D F _c	719 .. D	70 .. D	72 .. D
mm	–	N				N			
6	6	–	–	260	–	–	–	430	–
7	7	–	–	310	490	–	–	410	550
8	8	–	–	450	490	–	–	490	600
9	9	–	–	600	650	–	–	490	600
10	00	370	500	600	850	240	280	500	700
12	01	430	600	700	1 000	210	280	470	700
15	02	550	650	1 000	950	180	280	490	600
17	03	600	750	1 000	1 300	160	280	490	700
20	04	950	1 300	1 600	2 300	250	400	650	850
25	05	1 200	1 600	2 000	2 400	210	340	550	750
30	06	1 400	1 900	2 500	3 400	180	300	550	700
35	07	1 600	2 600	3 300	5 500	210	440	750	1 200
40	08	1 800	3 100	4 100	6 000	180	500	750	1 200
45	09	2 400	3 800	4 500	7 000	190	480	750	1 200
50	10	2 900	3 100	5 000	6 000	180	380	650	1 000
55	11	3 300	4 100	6 000	7 500	230	430	800	1 100
60	12	3 300	4 500	6 500	11 000	240	400	750	1 300
65	13	4 700	4 800	7 000	13 000	260	370	700	1 300
70	14	5 000	6 500	8 500	14 000	240	500	800	1 300
75	15	5 500	6 500	9 000	15 000	230	480	750	1 300
80	16	5 500	7 000	11 000	17 000	300	650	1 200	1 900
85	17	7 500	9 000	11 000	19 000	550	900	1 400	2 500
90	18	8 000	9 500	14 000	19 000	500	850	1 700	2 500
95	19	8 000	10 000	14 000	27 000	480	850	1 500	3 000
100	20	8 500	12 000	15 000	27 000	460	1 000	1 400	3 100
105	21	9 000	12 500	17 000	31 000	450	900	1 600	3 300
110	22	11 000	13 000	20 000	37 000	600	900	1 800	3 600
120	24	12 000	16 000	22 000	45 000	600	1 200	1 900	4 300
130	26	17 000	23 000	27 000	48 000	900	1 300	2 700	4 500
140	28	16 000	24 000	29 000	59 000	800	1 300	2 500	5 000
150	30	21 000	27 000	34 000	–	1 000	1 800	2 700	–
160	32	23 000	28 000	38 000	–	1 000	1 700	2 900	–
170	34	–	30 000	51 000	–	–	1 600	3 500	–
180	36	–	37 000	59 000	–	–	2 200	4 000	–
190	38	–	39 000	62 000	–	–	2 600	4 500	–
200	40	–	48 000	66 000	–	–	3 200	5 500	–
220	44	–	52 000	79 000	–	–	2 900	6 000	–
240	48	–	57 000	86 000	–	–	2 700	5 500	–
260	52	–	77 000	109 000	–	–	4 000	7 500	–
280	56	–	83 000	–	–	–	4 000	–	–
300	60	–	107 000	–	–	–	5 300	–	–
320	64	–	114 000	–	–	–	5 700	–	–
340	68	–	120 000	–	–	–	6 000	–	–
360	72	–	127 000	–	–	–	6 200	–	–

Table 33

Minimum axial clamping force and axial fitting force for precision lock nuts and end plates for E design bearings

Bore diameter d	Size	Minimum axial clamping force for bearings in the series		Axial fitting force for bearings in the series	
		719 .. E F_s	70 .. E	719 .. E F_c	70 .. E
mm	–	N		N	
6	6	–	260	–	430
7	7	–	310	–	410
8	8	330	450	280	490
9	9	400	600	280	490
10	00	500	650	280	550
12	01	600	700	280	470
15	02	650	1 000	280	490
17	03	750	1 000	280	490
20	04	1 300	1 600	400	650
25	05	1 600	1 800	340	500
30	06	1 900	2 500	300	550
35	07	2 600	3 300	440	750
40	08	3 100	4 100	500	750
45	09	3 800	4 500	480	750
50	10	3 100	5 000	380	650
55	11	4 100	6 000	430	800
60	12	4 500	6 500	400	750
65	13	4 800	7 000	370	700
70	14	6 500	8 500	500	800
75	15	6 500	9 000	480	750
80	16	7 000	11 000	650	1 200
85	17	9 000	11 000	900	1 400
90	18	9 500	16 000	850	1 700
95	19	10 000	14 000	850	1 500
100	20	12 000	15 000	1 000	1 400
110	22	13 000	20 000	900	1 800
120	24	16 000	22 000	1 200	1 900

Table 34

Minimum axial clamping force and axial fitting force for precision lock nuts and end plates for B design bearings

Bore diameter d	Size	Minimum axial clamping force for bearings in the series 719 .. B		Axial fitting force for bearings in the series 719 .. B	
		F_s	70 .. B	F_c	70 .. B
mm	–	N		N	
30	06	1 900	2 500	300	550
35	07	2 600	3 300	440	750
40	08	3 100	4 100	500	750
45	09	3 800	4 500	480	750
50	10	3 100	5 000	380	650
55	11	4 100	6 000	430	800
60	12	4 500	6 500	400	750
65	13	4 800	7 000	370	700
70	14	6 500	8 500	500	800
75	15	6 500	9 000	480	750
80	16	7 000	11 000	650	1 200
85	17	9 000	11 000	900	1 400
90	18	9 500	16 000	850	1 700
95	19	10 000	14 000	850	1 500
100	20	12 000	15 000	1 000	1 400
110	22	13 000	20 000	900	1 800
120	24	16 000	22 000	1 200	1 900

Table 35

Factor K for tightening torque calculation

Nominal thread diameter ¹⁾	Factor K for	
	precision lock nuts	end plate bolts
M 4	–	0,8
M 5	–	1
M 6	–	1,2
M 8	–	1,6
M 10	1,4	2
M 12	1,6	2,4
M 14	1,9	2,7
M 15	2	2,9
M 16	2,1	3,1
M 17	2,2	–
M 20	2,6	–
M 25	3,2	–
M 30	3,9	–
M 35	4,5	–
M 40	5,1	–
M 45	5,8	–
M 50	6,4	–
M 55	7	–
M 60	7,6	–
M 65	8,1	–
M 70	9	–
M 75	9,6	–
M 80	10	–
M 85	11	–
M 90	11	–
M 95	12	–
M 100	12	–
M 105	13	–
M 110	14	–
M 120	15	–
M 130	16	–
M 140	17	–
M 150	18	–
M 160	19	–
M 170	21	–
M 180	22	–
M 190	23	–
M 200	24	–
M 220	26	–
M 240	27	–
M 260	29	–
M 280	32	–
M 300	34	–
M 320	36	–
M 340	38	–
M 360	40	–

¹⁾ Applicable for fine threads only

Load carrying capacity of bearing sets

The values for basic load ratings (C , C_0) and fatigue load limit (P_u) listed in the product tables (→ page 198) apply to single bearings. For bearing sets, the corresponding values for single bearings should be multiplied by a factor, listed in table 36.

2

Table 36

Calculation factors for bearing sets

Number of bearings in a set	Calculation factor for		
	Basic dynamic load rating C	Basic static load rating C_0	Fatigue load limit P_u
2	1,62	2	2
3	2,16	3	3
4	2,64	4	4
5	3,09	5	5

Equivalent bearing loads

When determining the equivalent bearing load for preloaded angular contact ball bearings, preload must be taken into account. Depending on the operating conditions, the axial component of the bearing load F_a for a bearing pair, arranged back-to-back or face-to-face, can be determined approximately from the following equations.

For bearing pairs under radial load and mounted with an interference fit

$$F_a = G_m$$

For bearing pairs under radial load and preloaded by springs

$$F_a = G_{\text{springs}}$$

For bearing pairs under axial load and mounted with an interference fit

$$\begin{aligned} K_a \leq 3 G_m &\rightarrow F_a = G_m + 0,67 K_a \\ K_a > 3 G_m &\rightarrow F_a = K_a \end{aligned}$$

For bearing pairs under axial load and preloaded by springs

$$F_a = G_{\text{springs}} + K_a$$

where

F_a = axial component of the bearing load [N]

G_m = preload in the mounted bearing pair [N] (\rightarrow *Preload in mounted bearing sets*, page 162)

G_{springs} = preload given by the springs [N] (for spindle applications, the bearing rings subjected to spring load must be free to move axially)

K_a = external axial force acting on the bearing arrangement [N]

Equivalent dynamic bearing load

The equivalent dynamic bearing load can be determined as follows:

For single bearings and bearings arranged in tandem

$$\begin{aligned} F_a/F_r \leq e &\rightarrow P = F_r \\ F_a/F_r > e &\rightarrow P = X_2 F_r + Y_2 F_a \end{aligned}$$

For bearing pairs, arranged back-to-back or face-to-face

$$\begin{aligned} F_a/F_r \leq e &\rightarrow P = F_r + Y_1 F_a \\ F_a/F_r > e &\rightarrow P = X_2 F_r + Y_2 F_a \end{aligned}$$

The values for the factors e , X_2 , Y_1 and Y_2 depend on the bearing contact angle and are listed for:

- single bearings and bearings arranged in tandem (\rightarrow **table 37**)
- bearings paired back-to-back and face-to-face (\rightarrow **table 38**)

For bearings with a 15° contact angle, the factors e , Y_1 and Y_2 depend on the relationship $f_0 F_a/C_0$

where

P = equivalent dynamic load on the bearing set [kN]

F_r = radial load acting on the bearing set [kN]

F_a = axial load acting on the bearing set [kN]

f_0 = calculation factor (→ **product tables, page 198**)

C_0 = basic static load rating [kN] (→ **product tables**)

Equivalent static bearing load

The equivalent static bearing load can be determined as follows:

For single bearings and bearings arranged in tandem

$$P_0 = 0,5 F_r + Y_0 F_a$$

For bearing pairs, arranged back-to-back or face-to-face

$$P_0 = F_r + Y_0 F_a$$

where

P_0 = equivalent static load on the bearing set [kN]

F_r = radial load acting on the bearing set [kN]

F_a = axial load acting on the bearing set [kN]

If $P_0 < F_r$, $P_0 = F_r$ should be used.

The values for the factor Y_0 depend on the bearing contact angle and are listed for:

- single bearings and bearings arranged in tandem (→ **table 37**)
- bearings paired back-to-back and face-to-face (→ **table 38**)

Table 37

Factors for single bearings and bearings arranged in tandem

$f_0 F_a / C_0$	e	X_2	Y_2	Y_0
Contact angle 15° (Designation suffix CD, CE or CB)				
≤ 0,178	0,38	0,44	1,47	0,46
0,357	0,4	0,44	1,4	0,46
0,714	0,43	0,44	1,3	0,46
1,07	0,46	0,44	1,23	0,46
1,43	0,47	0,44	1,19	0,46
2,14	0,5	0,44	1,12	0,46
3,57	0,55	0,44	1,02	0,46
≥ 5,35	0,56	0,44	1	0,46
Contact angle 18° (Designation suffix FE or FB)				
–	0,57	0,43	1	0,42
Contact angle 25° (Designation suffix ACD, ACE or ACB)				
–	0,68	0,41	0,87	0,38

Table 38

Factors for bearings paired back-to-back or face-to-face

$2 f_0 F_a / C_0$	e	X_2	Y_1	Y_2	Y_0
Contact angle 15° (Designation suffix CD, CE or CB)					
≤ 0,178	0,38	0,72	1,65	2,39	0,92
0,357	0,4	0,72	1,57	2,28	0,92
0,714	0,43	0,72	1,46	2,11	0,92
1,07	0,46	0,72	1,38	2	0,92
1,43	0,47	0,72	1,34	1,93	0,92
2,14	0,5	0,72	1,26	1,82	0,92
3,57	0,55	0,72	1,14	1,66	0,92
≥ 5,35	0,56	0,72	1,12	1,63	0,92
Contact angle 18° (Designation suffix FE or FB)					
–	0,57	0,7	1,09	1,63	0,84
Contact angle 25° (Designation suffix ACD, ACE or ACB)					
–	0,68	0,67	0,92	1,41	0,76

Attainable speeds

The attainable speeds listed in the product tables (→ **page 198**) are guideline values and are valid under certain conditions. For additional information, refer to *Attainable speeds* on **page 44**.

Sealed bearings

As there is no friction generated at the seal lip, the attainable speed of a sealed bearing is equivalent to a same-sized open bearing.

Effect of lubrication

The values listed for oil-air lubrication should be reduced if other oil lubrication methods are used.

The values listed for grease lubrication are maximum values that can be attained with sealed bearings or open bearings with an appropriate fill of a suitable, high-quality, soft consistency grease. For additional information, contact the SKF application engineering service.

Adjusted bearings

If, in order to increase system rigidity, single bearings are adjusted so that a heavy preload results, the attainable speeds listed in the product tables should be reduced. For additional information, contact the SKF application engineering service.

Bearing sets

If bearing sets with two or more bearings mounted immediately adjacent to each other are used, the attainable speeds listed in the product tables need to be reduced. Values for the maximum rotational speeds in these cases can be obtained by multiplying the guideline value listed in the product tables by a reduction factor (dependent on the bearing design, preload, and the bearing arrangement) listed in **table 39**.

Spacer rings

If the calculated attainable speed is not sufficient for the application, precision-matched spacer rings in the bearing set (→ **fig. 20**) can be used to increase the speed capability.

Speed reduction factors for bearing sets

Number of bearings	Arrangement	Designation suffix for matched sets	Speed reduction factors for bearings in the series 718 .. D, 719 .. E and 70 .. E for preload class					
			A	L	B	M	C	F
2	Back-to-back	DB	0,8	–	0,65	–	0,4	–
	Face-to-face	DF	0,77	–	0,61	–	0,36	–
3	Back-to-back and tandem	TBT	0,69	0,72	0,49	0,58	0,25	0,36
	Face-to-face and tandem	TFT	0,63	0,66	0,42	0,49	0,17	0,24
4	Tandem back-to-back	QBC	0,64	–	0,53	–	0,32	–
	Tandem face-to-face	QFC	0,62	–	0,48	–	0,27	–

For spring-loaded tandem sets, designation suffix DT, a speed reduction factor of 0,9 should be applied.

Fig. 20

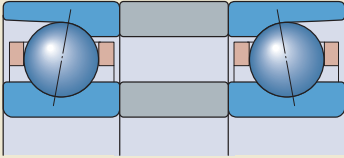

Table 39

719 .. B and 70 .. B for preload class			719 .. D, 70 .. D and 72 .. D for preload class			
A	B	C	A	B	C	D
0,83	0,78	0,58	0,81	0,75	0,65	0,4
0,8	0,74	0,54	0,77	0,72	0,61	0,36
0,72	0,66	0,4	0,7	0,63	0,49	0,25
0,64	0,56	0,3	0,63	0,56	0,42	0,17
0,67	0,64	0,48	0,64	0,6	0,53	0,32
0,64	0,6	0,41	0,62	0,58	0,48	0,27

Mounting

Pressing bearing sets together during hot mounting

Super-precision angular contact ball bearings are typically used in sets. When the bearings are heated, their bore diameter becomes larger and their width also expands. The larger bore diameter facilitates mounting.

When cooling, their bore diameter contracts to obtain the necessary (interference) fit. Their width also contracts and a small gap between the bearings can result. This gap can negatively impact the preload in the bearing set. To avoid this, the bearing inner rings should be pressed against each other while cooling (→ **fig. 21**) with an axial force that is slightly greater than the dismounting force. A force should never be applied directly or indirectly to the outer rings when pressing the bearings together.

Package markings

SKF super-precision bearings are distributed in SKF illustrated boxes (→ **fig. 22**). An instruction sheet, with information about mounting, is supplied in each box.

When selecting universally matchable angular contact ball bearings to make a set from existing stock, the package provides helpful information such as the mean outside and the mean bore diameter deviations from the nominal diameters as well as the actual bearing contact angle (→ **fig. 23**). Bearings with similar deviations and contact angles should be used together in a set.

Fig. 21

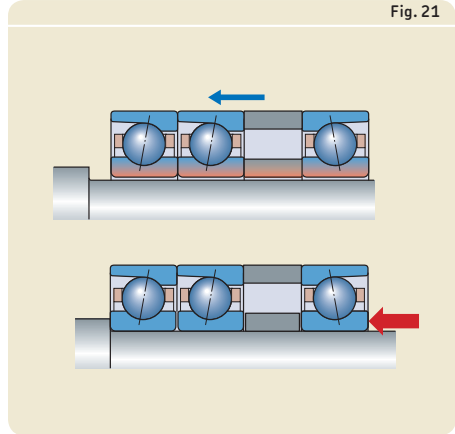

Fig. 22



Fig. 23



Designation system

Examples: Single bearing – 71922 CDGBTNHA/PA9AL
 Matched bearing set – S7010 ACD/HCP4QBCC

	719	22	CD	GB	TNHA	/	
S	70	10	ACD			/	

Prefix

- Open bearing (no designation prefix)
- S Sealed bearing
- V Bearing with NitroMax steel rings and bearing grade silicon nitride Si₃N₄ balls (hybrid bearing)

Bearing series

- 718 Angular contact ball bearing in accordance with ISO dimension series 18
- 719 Angular contact ball bearing in accordance with ISO dimension series 19
- 70 Angular contact ball bearing in accordance with ISO dimension series 10
- 72 Angular contact ball bearing in accordance with ISO dimension series 02

Bearing size

- 6 6 mm bore diameter
- 7 7 mm bore diameter
- 8 8 mm bore diameter
- 9 9 mm bore diameter
- 00 10 mm bore diameter
- 01 12 mm bore diameter
- 02 15 mm bore diameter
- 03 17 mm bore diameter
- 04 (x5) 20 mm bore diameter
- to
- 72 (x5) 360 mm bore diameter

Internal design

- CD 15° contact angle, high-capacity design
- ACD 25° contact angle, high-capacity design
- CE 15° contact angle, high-speed E design
- FE 18° contact angle, high-speed E design
- ACE 25° contact angle, high-speed E design
- CB 15° contact angle, high-speed B design
- FB 18° contact angle, high-speed B design
- ACB 25° contact angle, high-speed B design

Single bearing – execution and preload

- Single standalone bearing (no designation suffix) (718 .. D, 719 .. D, 70 .. D, 72 .. D, 719 .. E, 70 .. E, 719 .. B and 70 .. B series)
- GA Single, universally matchable, extra light preload (719 .. D, 70 .. D and 72 .. D series)
- GA Single, universally matchable, light preload (718 .. D, 719 .. E, 70 .. E, 719 .. B and 70 .. B series)
- GB Single, universally matchable, light preload (719 .. D, 70 .. D and 72 .. D series)
- GB Single, universally matchable, moderate preload (718 .. D, 719 .. E, 70 .. E, 719 .. B and 70 .. B series)
- GC Single, universally matchable, moderate preload (719 .. D, 70 .. D and 72 .. D series)
- GC Single, universally matchable, heavy preload (718 .. D, 719 .. E, 70 .. E, 719 .. B and 70 .. B series)
- GD Single, universally matchable, heavy preload (719 .. D, 70 .. D and 72 .. D series)

Cage

- Cotton fabric reinforced phenolic resin or carbon fibre reinforced PEEK, outer ring centred (no designation suffix)
- MA Machined brass, outer ring centred
- TNHA Glass fibre reinforced PEEK, outer ring centred

	PA9A	L		
HC	P4A		QBC	C

Bearing set – preload

- A** Extra light preload (719 .. D, 70 .. D and 72 .. D series)
- A** Light preload (718 .. D, 719 .. E, 70 .. E, 719 .. B and 70 .. B series)
- L** Light preload – only for matched bearings sets in TBT, TFT, QBT and QFT arrangements (718 .. D, 719 .. E and 70 .. E series)
- B** Light preload (719 .. D, 70 .. D and 72 .. D series)
- B** Moderate preload (718 .. D, 719 .. E, 70 .. E, 719 .. B and 70 .. B series)
- M** Moderate preload – only for matched bearings sets in TBT, TFT, QBT and QFT arrangements (718 .. D, 719 .. E and 70 .. E series)
- C** Moderate preload (719 .. D, 70 .. D and 72 .. D series)
- C** Heavy preload (718 .. D, 719 .. E, 70 .. E, 719 .. B and 70 .. B series)
- F** Heavy preload – only for matched bearings sets in TBT, TFT, QBT and QFT arrangements (718 .. D, 719 .. E and 70 .. E series)
- D** Heavy preload (719 .. D, 70 .. D and 72 .. D series)
- G...** Special preload, expressed in daN e.g. G240 (718 .. D, 719 .. D, 70 .. D, 72 .. D, 719 .. E, 70 .. E, 719 .. B and 70 .. B series)

Bearing set arrangement

- DB** Set of two bearings arranged back-to-back <>
- DF** Set of two bearings arranged face-to-face ><
- DT** Set of two bearings arranged in tandem <<
- DG** Set of two bearings for universal matching
- TBT** Set of three bearings arranged back-to-back and tandem <>>
- TFT** Set of three bearings arranged face-to-face and tandem ><<
- TT** Set of three bearings arranged in tandem <<<
- TG** Set of three bearings for universal matching
- QBC** Set of four bearings arranged tandem back-to-back <>>>
- QFC** Set of four bearings arranged tandem face-to-face >><<
- QBT** Set of four bearings arranged back-to-back and tandem <>>>
- QFT** Set of four bearings arranged face-to-face and tandem >><<
- QT** Set of four bearings arranged in tandem <<<<
- QG** Set of four bearings for universal matching
- PBC** Set of five bearings arranged tandem back-to-back <>>>>
- PFC** Set of five bearings arranged tandem face-to-face >><<<
- PBT** Set of five bearings arranged back-to-back and tandem <>>>>
- PFT** Set of five bearings arranged face-to-face and tandem >><<<
- PT** Set of five bearings arranged in tandem <<<<<
- PG** Set of five bearings for universal matching

Lubrication features

- H** Two lubrication holes on the non-thrust side of the outer ring
- H1** Two lubrication holes on the thrust side of the outer ring
- L** Annular groove with two lubrication holes on the non-thrust side of the outer ring and two annular grooves fitted with O-rings in the outer ring
- L1** Annular groove with two lubrication holes on the thrust side of the outer ring and two annular grooves fitted with O-rings in the outer ring

Accuracy

- P4** Dimensional and running accuracy in accordance with ISO tolerance class 4
- P4A** Dimensional accuracy in accordance with ISO tolerance class 4, running accuracy better than ISO tolerance class 4
- P2** Dimensional and running accuracy in accordance with ISO tolerance class 2
- PA9A** Dimensional and running accuracy in accordance with ISO tolerance class 2

Ball material

- Carbon chromium steel (no designation suffix)
- HC** Balls made of bearing grade silicon nitride Si₃N₄ (hybrid bearing)

2.1 Angular contact ball bearings

d 6 – 8 mm

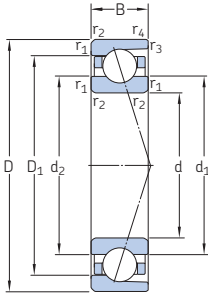

ACD, CD

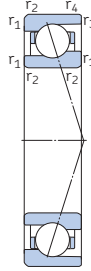

719 .. ACE,
719 .. CE

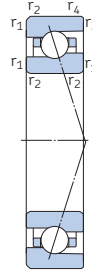

70 .. ACE,
70 .. CE

Principal dimensions	Basic load ratings		Fatigue load limit P_u	Attainable speeds		Mass	Designation	Available variants				
	dynamic C	static C_0		Grease lubrication	Oil-air lubrication			Sealing	Direct oil-air solution lubrication ¹⁾			
d	D	B	kN	kN	r/min	kg	-	-	-			
mm	mm	mm	kN	kN	r/min	kg	-	-	-			
6	17	6	1,51	0,49	0,02	127 000	195 000	0,006	706 ACE/P4A	-	H	
	17	6	1,51	0,49	0,02	150 000	230 000	0,005	706 ACE/HCP4A	-	H	
	17	6	1,56	0,5	0,022	140 000	220 000	0,006	706 CE/P4A	-	H	
	17	6	1,56	0,5	0,022	170 000	260 000	0,005	706 CE/HCP4A	-	H	
	17	6	1,95	0,75	0,032	110 000	160 000	0,006	706 ACD/P4A	-	H	
	17	6	1,95	0,75	0,032	130 000	190 000	0,005	706 ACD/HCP4A	-	H	
	17	6	2,03	0,765	0,032	120 000	180 000	0,006	706 CD/P4A	-	H	
	17	6	2,03	0,765	0,032	140 000	220 000	0,005	706 CD/HCP4A	-	H	
	7	19	6	1,86	0,62	0,026	112 000	175 000	0,007	707 ACE/P4A	-	H
		19	6	1,86	0,62	0,026	133 000	205 000	0,006	707 ACE/HCP4A	-	H
		19	6	1,95	0,64	0,027	127 000	190 000	0,007	707 CE/P4A	-	H
		19	6	1,95	0,64	0,027	150 000	230 000	0,006	707 CE/HCP4A	-	H
19		6	2,42	0,95	0,04	95 000	140 000	0,008	707 ACD/P4A	-	H	
19		6	2,42	0,95	0,04	110 000	170 000	0,007	707 ACD/HCP4A	-	H	
19		6	2,51	0,98	0,04	100 000	160 000	0,008	707 CD/P4A	-	H	
19		6	2,51	0,98	0,04	120 000	190 000	0,007	707 CD/HCP4A	-	H	
22		7	2,91	1,12	0,048	70 000	110 000	0,013	727 ACD/P4A	-	-	
22		7	2,91	1,12	0,048	85 000	130 000	0,012	727 ACD/HCP4A	-	-	
22		7	2,96	1,16	0,049	80 000	120 000	0,013	727 CD/P4A	-	-	
22		7	2,96	1,16	0,049	95 000	150 000	0,012	727 CD/HCP4A	-	-	
8	19	6	1,68	0,6	0,026	109 000	165 000	0,007	719/8 ACE/P4A	-	H	
	19	6	1,68	0,6	0,026	130 000	200 000	0,006	719/8 ACE/HCP4A	-	H	
	19	6	1,74	0,63	0,027	120 000	185 000	0,007	719/8 CE/P4A	-	H	
	19	6	1,74	0,63	0,027	145 000	220 000	0,006	719/8 CE/HCP4A	-	H	
	22	7	2,29	0,765	0,032	98 000	150 000	0,012	708 ACE/P4A	-	H	
	22	7	2,29	0,765	0,032	115 000	180 000	0,011	708 ACE/HCP4A	-	H	
	22	7	2,34	0,8	0,034	109 000	165 000	0,012	708 CE/P4A	-	H	
	22	7	2,34	0,8	0,034	130 000	200 000	0,011	708 CE/HCP4A	-	H	
	22	7	3,19	1,34	0,056	80 000	120 000	0,012	708 ACD/P4A	-	H	
	22	7	3,19	1,34	0,056	95 000	150 000	0,011	708 ACD/HCP4A	-	H	
	22	7	3,25	1,37	0,057	90 000	130 000	0,012	708 CD/P4A	-	H	
	22	7	3,25	1,37	0,057	110 000	160 000	0,011	708 CD/HCP4A	-	H	

¹⁾ Designation suffix H, H1, L or L1. For details, refer to *Direct oil-air lubrication* (→ page 136).

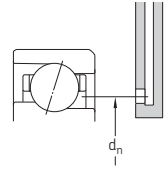
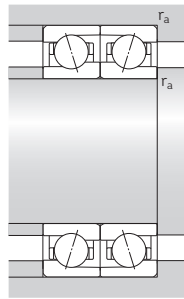
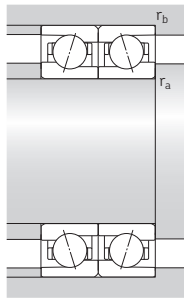
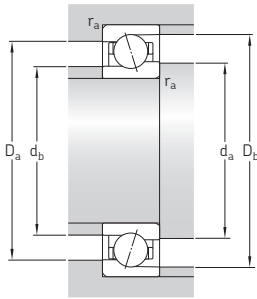

Dimensions					Abutment and fillet dimensions								Reference grease quantity ¹⁾	Calculation factor		
d	d ₁	d ₂	D ₁	D ₂	r _{1,2} min.	r _{3,4} min.	d _a min.	d _b min.	D _a max.	D _b max.	r _a max.	r _b max.	d _n	G _{ref}	f ₀	
mm														cm ³	–	
6	9,2	8,7	13,9	–	0,3	0,15	8	8	15	15,6	0,3	0,15	10,1	0,09	–	
	9,2	8,7	13,9	–	0,3	0,15	8	8	15	15,6	0,3	0,15	10,1	0,09	–	
	9,2	8,7	13,9	–	0,3	0,15	8	8	15	15,6	0,3	0,15	10,1	0,09	6,4	
	9,2	8,7	13,9	–	0,3	0,15	8	8	15	15,6	0,3	0,15	10,1	0,09	6,4	
	9,5	9,5	13,5	–	0,3	0,15	8	8	15	16,2	0,3	0,15	10,3	0,09	–	
	9,5	9,5	13,5	–	0,3	0,15	8	8	15	16,2	0,3	0,15	10,3	0,09	–	
	9,5	9,5	13,5	–	0,3	0,15	8	8	15	16,2	0,3	0,15	10,3	0,09	8,3	
	9,5	9,5	13,5	–	0,3	0,15	8	8	15	16,2	0,3	0,15	10,3	0,09	8,3	
	7	10,4	9,9	15,7	–	0,3	0,15	9	9	17	17,6	0,3	0,15	11,4	0,11	–
		10,4	9,9	15,7	–	0,3	0,15	9	9	17	17,6	0,3	0,15	11,4	0,11	–
		10,4	9,9	15,7	–	0,3	0,15	9	9	17	17,6	0,3	0,15	11,4	0,11	6,5
		10,4	9,9	15,7	–	0,3	0,15	9	9	17	17,6	0,3	0,15	11,4	0,11	6,5
10,8		10,8	15,2	–	0,3	0,15	9	9	17	18,2	0,3	0,15	11,7	0,12	–	
10,8		10,8	15,2	–	0,3	0,15	9	9	17	18,2	0,3	0,15	11,7	0,12	–	
10,8		10,8	15,2	–	0,3	0,15	9	9	17	18,2	0,3	0,15	11,7	0,12	8,1	
10,8		10,8	15,2	–	0,3	0,15	9	9	17	18,2	0,3	0,15	11,7	0,12	8,1	
12,6		12,6	17,4	–	0,3	0,2	9,4	9,4	19,6	20,2	0,3	0,2	13,6	0,16	–	
12,6		12,6	17,4	–	0,3	0,2	9,4	9,4	19,6	20,2	0,3	0,2	13,6	0,16	–	
12,6		12,6	17,4	–	0,3	0,2	9,4	9,4	19,6	20,2	0,3	0,2	13,6	0,16	8,4	
12,6		12,6	17,4	–	0,3	0,2	9,4	9,4	19,6	20,2	0,3	0,2	13,6	0,16	8,4	
8	11,3	10,8	15,7	–	0,3	0,15	10	10	17	18,2	0,3	0,15	12,2	0,09	–	
	11,3	10,8	15,7	–	0,3	0,15	10	10	17	18,2	0,3	0,15	12,2	0,09	–	
	11,3	10,8	15,7	–	0,3	0,15	10	10	17	18,2	0,3	0,15	12,2	0,09	7,2	
	11,3	10,8	15,7	–	0,3	0,15	10	10	17	18,2	0,3	0,15	12,2	0,09	7,2	
	12,1	11,5	17,9	–	0,3	0,15	10	10	20	20,6	0,3	0,15	13,3	0,17	–	
	12,1	11,5	17,9	–	0,3	0,15	10	10	20	20,6	0,3	0,15	13,3	0,17	–	
	12,1	11,5	17,9	–	0,3	0,15	10	10	20	20,6	0,3	0,15	13,3	0,17	6,6	
	12,1	11,5	17,9	–	0,3	0,15	10	10	20	20,6	0,3	0,15	13,3	0,17	6,6	
	12,6	12,6	17,4	–	0,3	0,2	10	10	20	20,6	0,3	0,2	13,6	0,15	–	
	12,6	12,6	17,4	–	0,3	0,2	10	10	20	20,6	0,3	0,2	13,6	0,15	–	
	12,6	12,6	17,4	–	0,3	0,2	10	10	20	20,6	0,3	0,2	13,6	0,15	8,4	
	12,6	12,6	17,4	–	0,3	0,2	10	10	20	20,6	0,3	0,2	13,6	0,15	8,4	

¹⁾ For calculating the initial grease fill → page 101

2.1 Angular contact ball bearings

d 8 – 10 mm

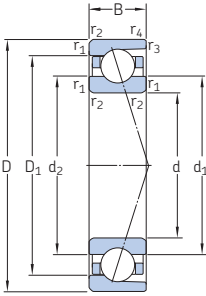

ACD, CD

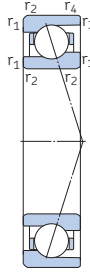

719 .. ACE,
719 .. CE

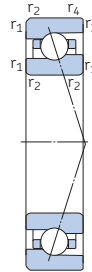

70 .. ACE,
70 .. CE

Principal dimensions	Basic load ratings		Fatigue load limit P_u	Attainable speeds		Mass	Designation	Available variants			
	dynamic C	static C_0		Grease lubrication	Oil-air lubrication			Sealing	Direct oil-air solution lubrication ¹⁾		
d	D	B									
mm			kN		r/min	kg	–		–		
8 cont.	24	8	3,58	1,34	0,057	67 000	100 000	0,017	728 ACD/P4A	–	–
	24	8	3,58	1,34	0,057	75 000	120 000	0,015	728 ACD/HCP4A	–	–
	24	8	3,71	1,37	0,057	70 000	110 000	0,017	728 CD/P4A	–	–
	24	8	3,71	1,37	0,057	85 000	130 000	0,015	728 CD/HCP4A	–	–
9	20	6	1,95	0,765	0,032	100 000	150 000	0,008	719/9 ACE/P4A	–	H
	20	6	1,95	0,765	0,032	120 000	180 000	0,007	719/9 ACE/HCP4A	–	H
	20	6	2,03	0,8	0,034	109 000	165 000	0,008	719/9 CE/P4A	–	H
	20	6	2,03	0,8	0,034	133 000	200 000	0,007	719/9 CE/HCP4A	–	H
	24	7	2,51	0,9	0,038	90 000	137 000	0,014	709 ACE/P4A	–	H
	24	7	2,51	0,9	0,038	106 000	165 000	0,013	709 ACE/HCP4A	–	H
	24	7	2,6	0,93	0,04	98 000	150 000	0,014	709 CE/P4A	–	H
	24	7	2,6	0,93	0,04	120 000	180 000	0,013	709 CE/HCP4A	–	H
	24	7	3,45	1,53	0,064	75 000	110 000	0,015	709 ACD/P4A	–	H
	24	7	3,45	1,53	0,064	85 000	130 000	0,013	709 ACD/HCP4A	–	H
	24	7	3,58	1,6	0,068	80 000	120 000	0,015	709 CD/P4A	–	H
	24	7	3,58	1,6	0,068	95 000	150 000	0,013	709 CD/HCP4A	–	H
	26	8	3,97	1,6	0,067	60 000	90 000	0,02	729 ACD/P4A	–	–
	26	8	3,97	1,6	0,067	70 000	110 000	0,018	729 ACD/HCP4A	–	–
	26	8	4,1	1,66	0,071	67 000	100 000	0,02	729 CD/P4A	–	–
	26	8	4,1	1,66	0,071	80 000	120 000	0,018	729 CD/HCP4A	–	–
10	19	5	1,78	0,93	0,04	70 000	110 000	0,005	71800 ACD/P4	–	–
	19	5	1,78	0,93	0,04	85 000	130 000	0,005	71800 ACD/HCP4	–	–
	19	5	1,9	0,98	0,043	80 000	120 000	0,005	71800 CD/P4	–	–
	19	5	1,9	0,98	0,043	95 000	150 000	0,005	71800 CD/HCP4	–	–
22	6	1,95	0,78	0,032	93 000	140 000	0,009	71900 ACE/P4A	–	H	
22	6	1,95	0,78	0,032	109 000	165 000	0,008	71900 ACE/HCP4A	–	H	
22	6	2,03	0,815	0,034	100 000	155 000	0,009	71900 CE/P4A	–	H	
22	6	2,03	0,815	0,034	123 000	185 000	0,008	71900 CE/HCP4A	–	H	

¹⁾ Designation suffix H, H1, L or L1. For details, refer to *Direct oil-air lubrication* (→ page 136).

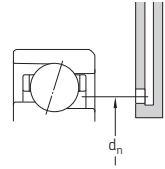
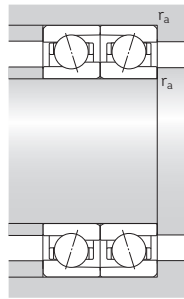
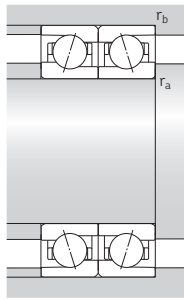
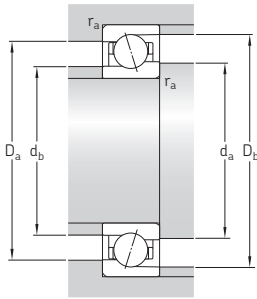

Dimensions					Abutment and fillet dimensions									Reference grease quantity ¹⁾	Calculation factor	
d	d ₁	d ₂	D ₁	D ₂	r _{1,2} min.	r _{3,4} min.	d _a min.	d _b min.	D _a max.	D _b max.	r _a max.	r _b max.	d _n	G _{ref}	f ₀	
mm															cm ³	–
8 cont.	13.1	13.1	18.9	–	0.3	0.2	10.4	10.4	21.6	22.2	0.3	0.2	14.3	0.23	–	
	13.1	13.1	18.9	–	0.3	0.2	10.4	10.4	21.6	22.2	0.3	0.2	14.3	0.23	–	
	13.1	13.1	18.9	–	0.3	0.2	10.4	10.4	21.6	22.2	0.3	0.2	14.3	0.23	7.9	
	13.1	13.1	18.9	–	0.3	0.2	10.4	10.4	21.6	22.2	0.3	0.2	14.3	0.23	7.9	
9	12.5	11.8	16.5	–	0.3	0.15	11	11	18	19.2	0.3	0.15	13.3	0.09	–	
	12.5	11.8	16.5	–	0.3	0.15	11	11	18	19.2	0.3	0.15	13.3	0.09	–	
	12.5	11.8	16.5	–	0.3	0.15	11	11	18	19.2	0.3	0.15	13.3	0.09	7.4	
	12.5	11.8	16.5	–	0.3	0.15	11	11	18	19.2	0.3	0.15	13.3	0.09	7.4	
	13.6	13	19.4	–	0.3	0.15	11	11	22	22.6	0.3	0.15	14.8	0.19	–	
	13.6	13	19.4	–	0.3	0.15	11	11	22	22.6	0.3	0.15	14.8	0.19	–	
	13.6	13	19.4	–	0.3	0.15	11	11	22	22.6	0.3	0.15	14.8	0.19	6.8	
	13.6	13	19.4	–	0.3	0.15	11	11	22	22.6	0.3	0.15	14.8	0.19	6.8	
	14.1	14.1	18.9	–	0.3	0.2	11	11	22	22.6	0.3	0.2	15.1	0.18	–	
	14.1	14.1	18.9	–	0.3	0.2	11	11	22	22.6	0.3	0.2	15.1	0.18	–	
	14.1	14.1	18.9	–	0.3	0.2	11	11	22	22.6	0.3	0.2	15.1	0.18	8.8	
	14.1	14.1	18.9	–	0.3	0.2	11	11	22	22.6	0.3	0.2	15.1	0.18	8.8	
10	15.1	15.1	20.9	–	0.3	0.2	11.4	11.4	23.6	24.2	0.3	0.2	16.3	0.26	–	
	15.1	15.1	20.9	–	0.3	0.2	11.4	11.4	23.6	24.2	0.3	0.2	16.3	0.26	–	
	15.1	15.1	20.9	–	0.3	0.2	11.4	11.4	23.6	24.2	0.3	0.2	16.3	0.26	8.3	
	15.1	15.1	20.9	–	0.3	0.2	11.4	11.4	23.6	24.2	0.3	0.2	16.3	0.26	8.3	
	13.1	13.1	16.1	–	0.3	0.15	12	12	17	18.2	0.3	0.15	13.4	0.06	–	
	13.1	13.1	16.1	–	0.3	0.15	12	12	17	18.2	0.3	0.15	13.4	0.06	–	
	13.1	13.1	16.1	–	0.3	0.15	12	12	17	18.2	0.3	0.15	13.4	0.06	15	
	13.1	13.1	16.1	–	0.3	0.15	12	12	17	18.2	0.3	0.15	13.4	0.06	15	
14	13.3	17.9	–	0.3	0.15	12	12	20	21.2	0.3	0.15	14.8	0.1	–		
14	13.3	17.9	–	0.3	0.15	12	12	20	21.2	0.3	0.15	14.8	0.1	–		
14	13.3	17.9	–	0.3	0.15	12	12	20	21.2	0.3	0.15	14.8	0.1	7.6		
14	13.3	17.9	–	0.3	0.15	12	12	20	21.2	0.3	0.15	14.8	0.1	7.6		

¹⁾ For calculating the initial grease fill → page 101

2.1 Angular contact ball bearings

d 10 – 12 mm

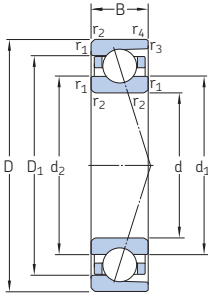

ACD, CD

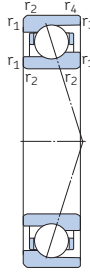

719 .. ACE,
719 .. CE

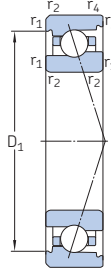

70 .. ACE,
70 .. CE

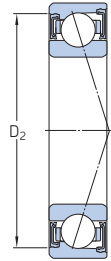

S... 1)

Principal dimensions	Basic load ratings		Fatigue load limit P_u	Attainable speeds		Mass ²⁾	Designation	Available variants				
	dynamic C	static C_0		Grease lubrication	Oil-air lubrication ²⁾			Sealing solution ¹⁾	Direct oil-air lubrication ³⁾			
d	D	B										
mm			kN	kN	r/min	kg	-	-	-			
10	cont.	22	6	2,42	1,06	0,045	63 000	95 000	0,009	71900 ACD/P4A	S	-
		22	6	2,42	1,06	0,045	70 000	110 000	0,009	71900 ACD/HCP4A	S	-
		22	6	2,51	1,1	0,048	70 000	110 000	0,009	71900 CD/P4A	S	-
		22	6	2,51	1,1	0,048	80 000	120 000	0,009	71900 CD/HCP4A	S	-
	26	8	2,86	1,14	0,048	83 000	127 000	0,019	7000 ACE/P4A	S	H	
	26	8	2,86	1,14	0,048	98 000	150 000	0,017	7000 ACE/HCP4A	S	H	
	26	8	3,02	1,18	0,05	90 000	140 000	0,019	7000 CE/P4A	S	H	
	26	8	3,02	1,18	0,05	109 000	165 000	0,017	7000 CE/HCP4A	S	H	
	26	8	3,97	1,6	0,067	67 000	100 000	0,019	7000 ACD/P4A	S	H	
	26	8	3,97	1,6	0,067	80 000	120 000	0,017	7000 ACD/HCP4A	S	H	
	26	8	4,1	1,66	0,071	75 000	110 000	0,019	7000 CD/P4A	S	H	
	26	8	4,1	1,66	0,071	90 000	140 000	0,017	7000 CD/HCP4A	S	H	
12		30	9	4,36	1,86	0,078	53 000	80 000	0,032	7200 ACD/P4A	S	-
		30	9	4,36	1,86	0,078	63 000	95 000	0,029	7200 ACD/HCP4A	S	-
		30	9	4,49	1,93	0,08	60 000	90 000	0,032	7200 CD/P4A	S	-
		30	9	4,49	1,93	0,08	70 000	100 000	0,029	7200 CD/HCP4A	S	-
	21	5	1,95	1,12	0,048	63 000	95 000	0,006	71801 ACD/P4	-	-	
	21	5	1,95	1,12	0,048	75 000	110 000	0,006	71801 ACD/HCP4	-	-	
	21	5	2,08	1,18	0,05	70 000	110 000	0,006	71801 CD/P4	-	-	
	21	5	2,08	1,18	0,05	85 000	130 000	0,006	71801 CD/HCP4	-	-	
	24	6	2,03	0,865	0,036	83 000	123 000	0,01	71901 ACE/P4A	-	H	
	24	6	2,03	0,865	0,036	98 000	150 000	0,009	71901 ACE/HCP4A	-	H	
	24	6	2,12	0,915	0,039	90 000	137 000	0,01	71901 CE/P4A	-	H	
	24	6	2,12	0,915	0,039	109 000	165 000	0,009	71901 CE/HCP4A	-	H	
24	6	2,55	1,18	0,05	56 000	85 000	0,01	71901 ACD/P4A	S	-		
24	6	2,55	1,18	0,05	67 000	100 000	0,01	71901 ACD/HCP4A	S	-		
24	6	2,65	1,25	0,053	63 000	95 000	0,01	71901 CD/P4A	S	-		
24	6	2,65	1,25	0,053	75 000	110 000	0,01	71901 CD/HCP4A	S	-		

1) Designation prefix S. For details, refer to *Sealing solutions* (→ page 136).

2) Applicable to open bearings only.

3) Designation suffix H, H1, L or L1. For details, refer to *Direct oil-air lubrication* (→ page 136).

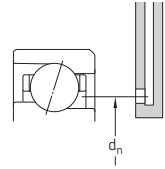
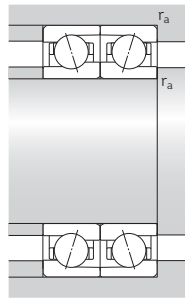
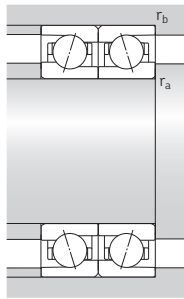
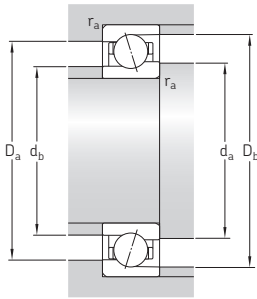

Dimensions					Abutment and fillet dimensions								Reference grease quantity ¹⁾	Calculation factor	
d	d ₁	d ₂	D ₁	D ₂	r _{1,2} min.	r _{3,4} min.	d _a min.	d _b min.	D _a max.	D _b max.	r _a max.	r _b max.	d _n	G _{ref}	f ₀
mm														cm ³	–
10 cont.	14	14	18	19,8	0,3	0,2	12	12	20	20,6	0,3	0,2	14,8	0,12	–
	14	14	18	19,8	0,3	0,2	12	12	20	20,6	0,3	0,2	14,8	0,12	–
	14	14	18	19,8	0,3	0,2	12	12	20	20,6	0,3	0,2	14,8	0,12	9,5
	14	14	18	19,8	0,3	0,2	12	12	20	20,6	0,3	0,2	14,8	0,12	9,5
	15,6	14,5	22,4	22,4	0,3	0,3	12	12	24	23,6	0,3	0,3	16,5	0,28	–
	15,6	14,5	22,4	22,4	0,3	0,3	12	12	24	23,6	0,3	0,3	16,5	0,28	–
	15,6	14,5	22,4	22,4	0,3	0,3	12	12	24	23,6	0,3	0,3	16,5	0,28	7,1
	15,6	14,5	22,4	22,4	0,3	0,3	12	12	24	23,6	0,3	0,3	16,5	0,28	7,1
	15,1	15,1	20,9	23,5	0,3	0,2	12	12	24	24,6	0,3	0,2	16	0,24	–
	15,1	15,1	20,9	23,5	0,3	0,2	12	12	24	24,6	0,3	0,2	16	0,24	–
	15,1	15,1	20,9	23,5	0,3	0,2	12	12	24	24,6	0,3	0,2	16	0,24	8,3
	15,1	15,1	20,9	23,5	0,3	0,2	12	12	24	24,6	0,3	0,2	16	0,24	8,3
	17,3	17,3	23,1	24,3	0,6	0,3	14,2	14,2	25,8	27,6	0,6	0,3	18,3	0,36	–
	17,3	17,3	23,1	24,3	0,6	0,3	14,2	14,2	25,8	27,6	0,6	0,3	18,3	0,36	–
	17,3	17,3	23,1	24,3	0,6	0,3	14,2	14,2	25,8	27,6	0,6	0,3	18,3	0,36	8,8
	17,3	17,3	23,1	24,3	0,6	0,3	14,2	14,2	25,8	27,6	0,6	0,3	18,3	0,36	8,8
12	15,1	15,1	18,1	–	0,3	0,15	14	14	19	20,2	0,3	0,15	15,4	0,07	–
	15,1	15,1	18,1	–	0,3	0,15	14	14	19	20,2	0,3	0,15	15,4	0,07	–
	15,1	15,1	18,1	–	0,3	0,15	14	14	19	20,2	0,3	0,15	15,4	0,07	15,4
	15,1	15,1	18,1	–	0,3	0,15	14	14	19	20,2	0,3	0,15	15,4	0,07	15,4
	16	15,3	20	–	0,3	0,15	14	14	22	23,2	0,3	0,15	16,8	0,1	–
	16	15,3	20	–	0,3	0,15	14	14	22	23,2	0,3	0,15	16,8	0,1	–
	16	15,3	20	–	0,3	0,15	14	14	22	23,2	0,3	0,15	16,8	0,1	7,8
	16	15,3	20	–	0,3	0,15	14	14	22	23,2	0,3	0,15	16,8	0,1	7,8
	16	16	20	21,8	0,3	0,2	14	14	22	22,6	0,3	0,2	16,8	0,12	–
	16	16	20	21,8	0,3	0,2	14	14	22	22,6	0,3	0,2	16,8	0,12	–
	16	16	20	21,8	0,3	0,2	14	14	22	22,6	0,3	0,2	16,8	0,12	9,8
	16	16	20	21,8	0,3	0,2	14	14	22	22,6	0,3	0,2	16,8	0,12	9,8

¹⁾ For calculating the initial grease fill → page 101

2.1 Angular contact ball bearings

d 12 – 15 mm

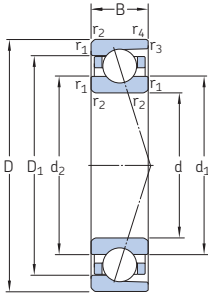

ACD, CD

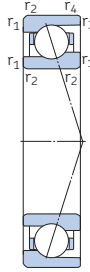

719 .. ACE,
719 .. CE

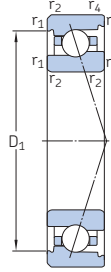

70 .. ACE,
70 .. CE

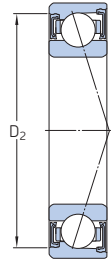

S... 1)

Principal dimensions	Basic load ratings		Fatigue load limit P_u	Attainable speeds		Mass ²⁾	Designation	Available variants			
	dynamic C	static C_0		Grease lubrication	Oil-air lubrication ²⁾			Sealing solution ¹⁾	Direct oil-air lubrication ³⁾		
d D B	kN		kN	r/min		kg	-	-			
mm	kN		kN	r/min		kg	-	-			
12 cont.	28	8	3,07	1,27	0,054	73 000	112 000	0,021	7001 ACE/P4A	S	H
	28	8	3,07	1,27	0,054	88 000	133 000	0,019	7001 ACE/HCP4A	S	H
	28	8	3,19	1,34	0,057	80 000	127 000	0,021	7001 CE/P4A	S	H
	28	8	3,19	1,34	0,057	98 000	150 000	0,019	7001 CE/HCP4A	S	H
	28	8	4,36	1,83	0,078	60 000	90 000	0,021	7001 ACD/P4A	S	H
	28	8	4,36	1,83	0,078	70 000	110 000	0,018	7001 ACD/HCP4A	S	H
	28	8	4,49	1,9	0,08	67 000	100 000	0,021	7001 CD/P4A	S	H
	28	8	4,49	1,9	0,08	80 000	120 000	0,018	7001 CD/HCP4A	S	H
	32	10	5,72	2,45	0,104	48 000	70 000	0,037	7201 ACD/P4A	S	-
	32	10	5,72	2,45	0,104	56 000	85 000	0,033	7201 ACD/HCP4A	S	-
	32	10	5,85	2,55	0,108	53 000	80 000	0,037	7201 CD/P4A	S	-
	32	10	5,85	2,55	0,108	67 000	95 000	0,033	7201 CD/HCP4A	S	-
15	24	5	2,16	1,4	0,06	53 000	80 000	0,007	71802 ACD/P4	-	-
	24	5	2,16	1,4	0,06	63 000	100 000	0,006	71802 ACD/HCP4	-	-
	24	5	2,29	1,5	0,063	60 000	90 000	0,007	71802 CD/P4	-	-
	24	5	2,29	1,5	0,063	70 000	110 000	0,006	71802 CD/HCP4	-	-
	28	7	3,02	1,34	0,057	68 000	106 000	0,015	71902 ACE/P4A	-	H
	28	7	3,02	1,34	0,057	83 000	127 000	0,013	71902 ACE/HCP4A	-	H
	28	7	3,19	1,4	0,06	75 000	115 000	0,015	71902 CE/P4A	-	H
	28	7	3,19	1,4	0,06	90 000	140 000	0,013	71902 CE/HCP4A	-	H
	28	7	3,77	1,8	0,078	50 000	75 000	0,015	71902 ACD/P4A	S	-
	28	7	3,77	1,8	0,078	60 000	90 000	0,014	71902 ACD/HCP4A	S	-
	28	7	3,97	1,9	0,08	56 000	85 000	0,015	71902 CD/P4A	S	-
	28	7	3,97	1,9	0,08	70 000	100 000	0,014	71902 CD/HCP4A	S	-
	32	9	4,23	1,83	0,078	63 000	95 000	0,028	7002 ACE/P4A	S	H
	32	9	4,23	1,83	0,078	75 000	115 000	0,025	7002 ACE/HCP4A	S	H
	32	9	4,42	1,93	0,08	68 000	106 000	0,028	7002 CE/P4A	S	H
	32	9	4,42	1,93	0,08	83 000	127 000	0,025	7002 CE/HCP4A	S	H

1) Designation prefix S. For details, refer to *Sealing solutions* (→ page 136).

2) Applicable to open bearings only.

3) Designation suffix H, H1, L or L1. For details, refer to *Direct oil-air lubrication* (→ page 136).

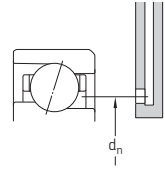
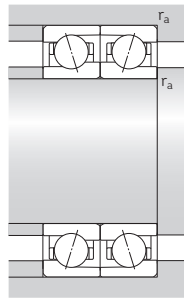
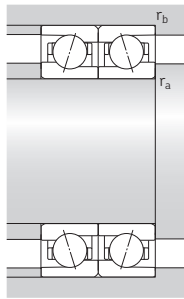
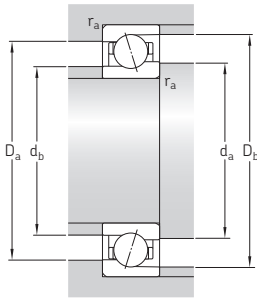

Dimensions					Abutment and fillet dimensions								Reference grease quantity ¹⁾	Calculation factor		
d	d ₁	d ₂	D ₁	D ₂	r _{1,2} min.	r _{3,4} min.	d _a min.	d _b min.	D _a max.	D _b max.	r _a max.	r _b max.	d _n	G _{ref}	f ₀	
mm															cm ³	–
12 cont.	17,5	16,5	24,4	24,4	0,3	0,15	14	14	26	26,6	0,3	0,15	18,5	0,31	–	
	17,5	16,5	24,4	24,4	0,3	0,15	14	14	26	26,6	0,3	0,15	18,5	0,31	–	
	17,5	16,5	24,4	24,4	0,3	0,15	14	14	26	26,6	0,3	0,15	18,5	0,31	7,3	
	17,5	16,5	24,4	24,4	0,3	0,15	14	14	26	26,6	0,3	0,15	18,5	0,31	7,3	
	17,1	17,1	22,9	25,5	0,3	0,2	14	14	26	26,6	0,3	0,2	18	0,27	–	
	17,1	17,1	22,9	25,5	0,3	0,2	14	14	26	26,6	0,3	0,2	18	0,27	–	
	17,1	17,1	22,9	25,5	0,3	0,2	14	14	26	26,6	0,3	0,2	18	0,27	8,7	
	17,1	17,1	22,9	25,5	0,3	0,2	14	14	26	26,6	0,3	0,2	18	0,27	8,7	
	18,6	18,6	25,4	26,6	0,6	0,3	16,2	16,2	27,8	29,6	0,6	0,3	20	0,51	–	
	18,6	18,6	25,4	26,6	0,6	0,3	16,2	16,2	27,8	29,6	0,6	0,3	20	0,51	–	
	18,6	18,6	25,4	26,6	0,6	0,3	16,2	16,2	27,8	29,6	0,6	0,3	20	0,51	8,5	
	18,6	18,6	25,4	26,6	0,6	0,3	16,2	16,2	27,8	29,6	0,6	0,3	20	0,51	8,5	
15	18,1	18,1	21,1	–	0,3	0,15	17	17	22	23,2	0,3	0,15	18,4	0,08	–	
	18,1	18,1	21,1	–	0,3	0,15	17	17	22	23,2	0,3	0,15	18,4	0,08	–	
	18,1	18,1	21,1	–	0,3	0,15	17	17	22	23,2	0,3	0,15	18,4	0,08	16	
	18,1	18,1	21,1	–	0,3	0,15	17	17	22	23,2	0,3	0,15	18,4	0,08	16	
	19,1	18,1	23,9	–	0,3	0,15	17	17	26	27,2	0,3	0,15	20	0,2	–	
	19,1	18,1	23,9	–	0,3	0,15	17	17	26	27,2	0,3	0,15	20	0,2	–	
	19,1	18,1	23,9	–	0,3	0,15	17	17	26	27,2	0,3	0,15	20	0,2	7,7	
	19,1	18,1	23,9	–	0,3	0,15	17	17	26	27,2	0,3	0,15	20	0,2	7,7	
	19,1	19,1	23,7	25,8	0,3	0,2	17	17	26	26,6	0,3	0,2	20,1	0,21	–	
	19,1	19,1	23,7	25,8	0,3	0,2	17	17	26	26,6	0,3	0,2	20,1	0,21	–	
	19,1	19,1	23,7	25,8	0,3	0,2	17	17	26	26,6	0,3	0,2	20,1	0,21	9,6	
	19,1	19,1	23,7	25,8	0,3	0,2	17	17	26	26,6	0,3	0,2	20,1	0,21	9,6	
20,7	19,5	28,8	28,8	0,3	0,15	17	17	30	30,6	0,3	0,15	21,9	0,5	–		
20,7	19,5	28,8	28,8	0,3	0,15	17	17	30	30,6	0,3	0,15	21,9	0,5	–		
20,7	19,5	28,8	28,8	0,3	0,15	17	17	30	30,6	0,3	0,15	21,9	0,5	7,3		
20,7	19,5	28,8	28,8	0,3	0,15	17	17	30	30,6	0,3	0,15	21,9	0,5	7,3		

¹⁾ For calculating the initial grease fill → page 101

2.1 Angular contact ball bearings d 15 – 17 mm

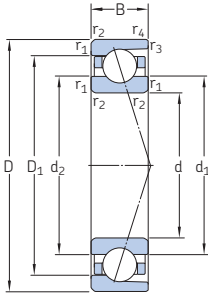

ACD, CD

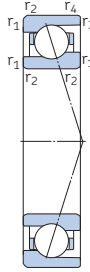

719 .. ACE,
719 .. CE

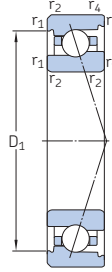

70 .. ACE,
70 .. CE

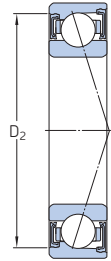

S... 1)

Principal dimensions	Basic load ratings		Fatigue load limit P_u	Attainable speeds		Mass ²⁾	Designation	Available variants			
	dynamic C	static C_0		Grease lubrication	Oil-air lubrication ²⁾			Sealing solution ¹⁾	Direct oil-air lubrication ³⁾		
d	D	B									
mm			kN		r/min	kg	–		–		
15 cont.	32	9	4,94	2,32	0,098	50 000	75 000	0,03	7002 ACD/P4A	S	H
	32	9	4,94	2,32	0,098	60 000	95 000	0,027	7002 ACD/HCP4A	S	H
	32	9	5,2	2,45	0,104	56 000	85 000	0,03	7002 CD/P4A	S	H
	32	9	5,2	2,45	0,104	67 000	100 000	0,027	7002 CD/HCP4A	S	H
17	35	11	7,15	3,2	0,134	43 000	63 000	0,043	7202 ACD/P4A	S	–
	35	11	7,15	3,2	0,134	50 000	75 000	0,037	7202 ACD/HCP4A	S	–
	35	11	7,41	3,35	0,14	48 000	70 000	0,043	7202 CD/P4A	S	–
	35	11	7,41	3,35	0,14	60 000	85 000	0,037	7202 CD/HCP4A	S	–
17	26	5	2,21	1,53	0,064	48 000	75 000	0,01	71803 ACD/P4	–	–
	26	5	2,21	1,53	0,064	60 000	90 000	0,009	71803 ACD/HCP4	–	–
	26	5	2,34	1,6	0,068	53 000	85 000	0,01	71803 CD/P4	–	–
	26	5	2,34	1,6	0,068	63 000	100 000	0,009	71803 CD/HCP4	–	–
	30	7	3,19	1,46	0,063	63 000	95 000	0,016	71903 ACE/P4A	–	H
	30	7	3,19	1,46	0,063	75 000	115 000	0,014	71903 ACE/HCP4A	–	H
	30	7	3,32	1,56	0,067	70 000	106 000	0,016	71903 CE/P4A	–	H
	30	7	3,32	1,56	0,067	83 000	127 000	0,014	71903 CE/HCP4A	–	H
	30	7	3,97	2	0,085	45 000	67 000	0,017	71903 ACD/P4A	S	–
	30	7	3,97	2	0,085	53 000	80 000	0,015	71903 ACD/HCP4A	S	–
	30	7	4,16	2,08	0,088	50 000	75 000	0,017	71903 CD/P4A	S	–
	30	7	4,16	2,08	0,088	63 000	90 000	0,015	71903 CD/HCP4A	S	–
	35	10	5,59	2,45	0,104	56 000	88 000	0,035	7003 ACE/P4A	S	H
	35	10	5,59	2,45	0,104	68 000	103 000	0,03	7003 ACE/HCP4A	S	H
	35	10	5,85	2,55	0,108	63 000	95 000	0,035	7003 CE/P4A	S	H
	35	10	5,85	2,55	0,108	75 000	115 000	0,03	7003 CE/HCP4A	S	H
35	10	6,5	3,1	0,132	45 000	70 000	0,038	7003 ACD/P4A	S	H	
35	10	6,5	3,1	0,132	56 000	85 000	0,033	7003 ACD/HCP4A	S	H	
35	10	6,76	3,25	0,137	50 000	75 000	0,038	7003 CD/P4A	S	H	
35	10	6,76	3,25	0,137	60 000	95 000	0,033	7003 CD/HCP4A	S	H	

1) Designation prefix S. For details, refer to *Sealing solutions* (→ page 136).

2) Applicable to open bearings only.

3) Designation suffix H, H1, L or L1. For details, refer to *Direct oil-air lubrication* (→ page 136).

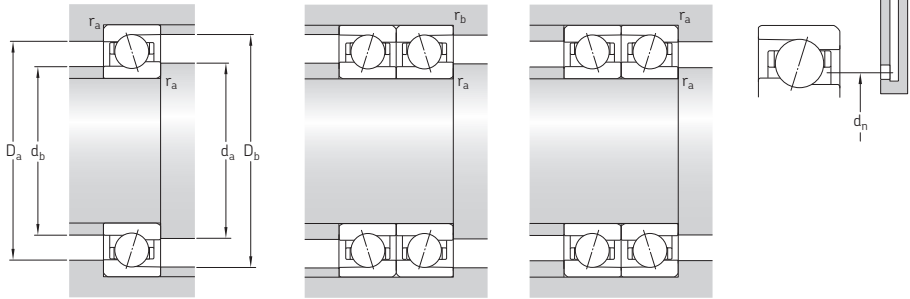

Dimensions					Abutment and fillet dimensions								Reference grease quantity ¹⁾	Calculation factor	
d	d ₁	d ₂	D ₁	D ₂	r _{1,2} min.	r _{3,4} min.	d _a min.	d _b min.	D _a max.	D _b max.	r _a max.	r _b max.	d _n	G _{ref}	f ₀
mm														cm ³	–
15 cont.	20,6	20,6	26,4	29,2	0,3	0,2	17	17	30	30,6	0,3	0,2	21,5	0,39	–
	20,6	20,6	26,4	29,2	0,3	0,2	17	17	30	30,6	0,3	0,2	21,5	0,39	–
	20,6	20,6	26,4	29,2	0,3	0,2	17	17	30	30,6	0,3	0,2	21,5	0,39	9,3
	20,6	20,6	26,4	29,2	0,3	0,2	17	17	30	30,6	0,3	0,2	21,5	0,39	9,3
	20,6	20,6	26,4	29,2	0,3	0,2	17	17	30	30,6	0,3	0,2	21,5	0,39	9,3
	21,4	21,4	29,1	30,7	0,6	0,3	19,2	19,2	30,8	32,6	0,6	0,3	23	0,73	–
	21,4	21,4	29,1	30,7	0,6	0,3	19,2	19,2	30,8	32,6	0,6	0,3	23	0,73	–
	21,4	21,4	29,1	30,7	0,6	0,3	19,2	19,2	30,8	32,6	0,6	0,3	23	0,73	8,5
	21,4	21,4	29,1	30,7	0,6	0,3	19,2	19,2	30,8	32,6	0,6	0,3	23	0,73	8,5
17	20,1	20,1	23	–	0,3	0,15	19	19	24	25,2	0,3	0,15	20,4	0,09	–
	20,1	20,1	23	–	0,3	0,15	19	19	24	25,2	0,3	0,15	20,4	0,09	–
	20,1	20,1	23	–	0,3	0,15	19	19	24	25,2	0,3	0,15	20,4	0,09	16,2
	20,1	20,1	23	–	0,3	0,15	19	19	24	25,2	0,3	0,15	20,4	0,09	16,2
	21,1	20,1	25,9	–	0,3	0,15	19	19	28	29,2	0,3	0,15	22	0,2	–
	21,1	20,1	25,9	–	0,3	0,15	19	19	28	29,2	0,3	0,15	22	0,2	–
	21,1	20,1	25,9	–	0,3	0,15	19	19	28	29,2	0,3	0,15	22	0,2	7,9
	21,1	20,1	25,9	–	0,3	0,15	19	19	28	29,2	0,3	0,15	22	0,2	7,9
	20,9	20,9	25,7	27,8	0,3	0,2	19	19	28	28,6	0,3	0,2	22,1	0,24	–
	20,9	20,9	25,7	27,8	0,3	0,2	19	19	28	28,6	0,3	0,2	22,1	0,24	–
	20,9	20,9	25,7	27,8	0,3	0,2	19	19	28	28,6	0,3	0,2	22,1	0,24	9,8
	20,9	20,9	25,7	27,8	0,3	0,2	19	19	28	28,6	0,3	0,2	22,1	0,24	9,8
	22,7	21,1	31,2	31,2	0,3	0,15	19	19	33	33,6	0,3	0,15	24,1	0,68	–
	22,7	21,1	31,2	31,2	0,3	0,15	19	19	33	33,6	0,3	0,15	24,1	0,68	–
	22,7	21,1	31,2	31,2	0,3	0,15	19	19	33	33,6	0,3	0,15	24,1	0,68	7,2
22,7	21,1	31,2	31,2	0,3	0,15	19	19	33	33,6	0,3	0,15	24,1	0,68	7,2	
22,6	22,6	29,3	32,4	0,3	0,2	19	19	33	33,6	0,3	0,2	23,7	0,54	–	
22,6	22,6	29,3	32,4	0,3	0,2	19	19	33	33,6	0,3	0,2	23,7	0,54	–	
22,6	22,6	29,3	32,4	0,3	0,2	19	19	33	33,6	0,3	0,2	23,7	0,54	9,1	
22,6	22,6	29,3	32,4	0,3	0,2	19	19	33	33,6	0,3	0,2	23,7	0,54	9,1	

¹⁾ For calculating the initial grease fill → page 101

2.1 Angular contact ball bearings d 17 – 20 mm

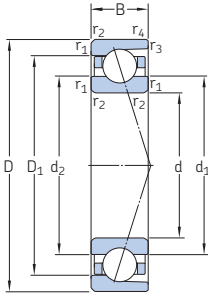

ACD, CD

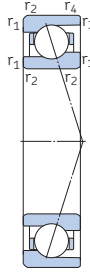

719 .. ACE,
719 .. CE

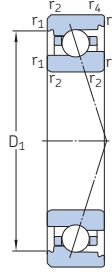

70 .. ACE,
70 .. CE

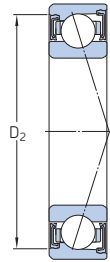

S... 1)

Principal dimensions	Basic load ratings		Fatigue load limit P_u	Attainable speeds		Mass ²⁾	Designation	Available variants			
	dynamic C	static C_0		Grease lubrication	Oil-air lubrication ²⁾			Sealing solution ¹⁾	Direct oil-air lubrication ³⁾		
d D B	kN		kN	r/min		kg	-	-			
mm	kN		kN	r/min		kg	-	-			
17 cont.	40	12	8,84	4	0,17	38 000	56 000	0,063	7203 ACD/P4A	S	-
	40	12	8,84	4	0,17	45 000	67 000	0,054	7203 ACD/HCP4A	S	-
	40	12	9,23	4,15	0,176	43 000	63 000	0,063	7203 CD/P4A	S	-
	40	12	9,23	4,15	0,176	53 000	75 000	0,054	7203 CD/HCP4A	S	-
20	32	7	3,64	2,5	0,106	40 000	63 000	0,018	71804 ACD/P4	-	-
	32	7	3,64	2,5	0,106	48 000	75 000	0,017	71804 ACD/HCP4	-	-
	32	7	3,9	2,65	0,112	45 000	70 000	0,018	71804 CD/P4	-	-
	32	7	3,9	2,65	0,112	53 000	80 000	0,017	71804 CD/HCP4	-	-
	37	9	4,68	2,28	0,098	52 000	78 000	0,036	71904 ACE/P4A	S	H, L
	37	9	4,68	2,28	0,098	60 000	95 000	0,032	71904 ACE/HCP4A	S	H, L
	37	9	4,88	2,4	0,102	56 000	88 000	0,036	71904 CE/P4A	S	H, L
	37	9	4,88	2,4	0,102	68 000	106 000	0,032	71904 CE/HCP4A	S	H, L
	37	9	5,72	3,05	0,129	38 000	56 000	0,035	71904 ACD/P4A	S	-
	37	9	5,72	3,05	0,129	45 000	67 000	0,033	71904 ACD/HCP4A	S	-
	37	9	6,05	3,2	0,137	43 000	63 000	0,035	71904 CD/P4A	S	-
	37	9	6,05	3,2	0,137	53 000	75 000	0,033	71904 CD/HCP4A	S	-
	42	12	7,15	3,25	0,137	48 000	75 000	0,064	7004 ACE/P4A	S	H1, L, L1
	42	12	7,15	3,25	0,137	58 000	88 000	0,056	7004 ACE/HCP4A	S	H1, L, L1
	42	12	7,41	3,35	0,143	54 000	83 000	0,064	7004 CE/P4A	S	H1, L, L1
	42	12	7,41	3,35	0,143	65 000	100 000	0,056	7004 CE/HCP4A	S	H1, L, L1
42	12	8,32	4,15	0,173	38 000	60 000	0,068	7004 ACD/P4A	S	H	
42	12	8,32	4,15	0,173	45 000	70 000	0,06	7004 ACD/HCP4A	S	H	
42	12	8,71	4,3	0,18	43 000	63 000	0,068	7004 CD/P4A	S	H	
42	12	8,71	4,3	0,18	50 000	80 000	0,06	7004 CD/HCP4A	S	H	
47	14	11,4	5,6	0,236	32 000	48 000	0,1	7204 ACD/P4A	S	-	
47	14	11,4	5,6	0,236	38 000	56 000	0,09	7204 ACD/HCP4A	S	-	
47	14	11,9	5,85	0,245	36 000	53 000	0,1	7204 CD/P4A	S	-	
47	14	11,9	5,85	0,245	43 000	60 000	0,09	7204 CD/HCP4A	S	-	

1) Designation prefix S. For details, refer to *Sealing solutions* (→ page 136).

2) Applicable to open bearings only.

3) Designation suffix H, H1, L or L1. For details, refer to *Direct oil-air lubrication* (→ page 136).

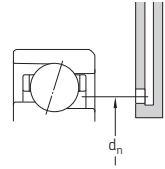
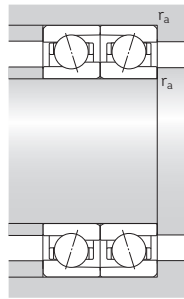
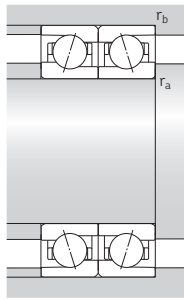
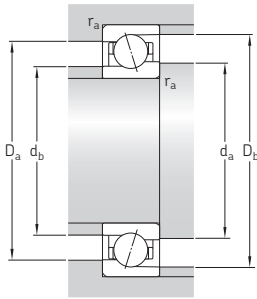

Dimensions					Abutment and fillet dimensions								Reference grease quantity ¹⁾	Calculation factor		
d	d ₁	d ₂	D ₁	D ₂	r _{1,2} min.	r _{3,4} min.	d _a min.	d _b min.	D _a max.	D _b max.	r _a max.	r _b max.	d _n	G _{ref}	f ₀	
mm															cm ³	–
17 cont.	24,1	24,1	32,8	34,4	0,6	0,3	21,2	21,2	35,8	37,6	0,6	0,3	25,9	1	–	
	24,1	24,1	32,8	34,4	0,6	0,3	21,2	21,2	35,8	37,6	0,6	0,3	25,9	1	–	
	24,1	24,1	32,8	34,4	0,6	0,3	21,2	21,2	35,8	37,6	0,6	0,3	25,9	1	8,5	
	24,1	24,1	32,8	34,4	0,6	0,3	21,2	21,2	35,8	37,6	0,6	0,3	25,9	1	8,5	
20	24,1	24,1	28,1	–	0,3	0,15	22	22	30	31,2	0,3	0,15	24,5	0,18	–	
	24,1	24,1	28,1	–	0,3	0,15	22	22	30	31,2	0,3	0,15	24,5	0,18	–	
	24,1	24,1	28,1	–	0,3	0,15	22	22	30	31,2	0,3	0,15	24,5	0,18	16	
	24,1	24,1	28,1	–	0,3	0,15	22	22	30	31,2	0,3	0,15	24,5	0,18	16	
	25,7	24,4	31,5	33,5	0,3	0,15	22	22	35	36,2	0,3	0,15	26,7	0,5	–	
	25,7	24,4	31,5	33,5	0,3	0,15	22	22	35	36,2	0,3	0,15	26,7	0,5	–	
	25,7	24,4	31,5	33,5	0,3	0,15	22	22	35	36,2	0,3	0,15	26,7	0,5	7,8	
	25,7	24,4	31,5	33,5	0,3	0,15	22	22	35	36,2	0,3	0,15	26,7	0,5	7,8	
	25,6	25,6	31,4	34	0,3	0,2	22	22	35	35,6	0,3	0,2	26,8	0,45	–	
	25,6	25,6	31,4	34	0,3	0,2	22	22	35	35,6	0,3	0,2	26,8	0,45	–	
	25,6	25,6	31,4	34	0,3	0,2	22	22	35	35,6	0,3	0,2	26,8	0,45	9,8	
	25,6	25,6	31,4	34	0,3	0,2	22	22	35	35,6	0,3	0,2	26,8	0,45	9,8	
	26,6	24,8	36,5	36,5	0,6	0,3	22	22	40	39,6	0,6	0,3	28,1	1,1	–	
	26,6	24,8	36,5	36,5	0,6	0,3	22	22	40	39,6	0,6	0,3	28,1	1,1	–	
	26,6	24,8	36,5	36,5	0,6	0,3	22	22	40	39,6	0,6	0,3	28,1	1,1	7,2	
	26,6	24,8	36,5	36,5	0,6	0,3	22	22	40	39,6	0,6	0,3	28,1	1,1	7,2	
27,1	27,1	34,8	37,1	0,6	0,3	23,2	23,2	38,8	40	0,6	0,3	28,4	0,9	–		
27,1	27,1	34,8	37,1	0,6	0,3	23,2	23,2	38,8	40	0,6	0,3	28,4	0,9	–		
27,1	27,1	34,8	37,1	0,6	0,3	23,2	23,2	38,8	40	0,6	0,3	28,4	0,9	9,2		
27,1	27,1	34,8	37,1	0,6	0,3	23,2	23,2	38,8	40	0,6	0,3	28,4	0,9	9,2		
29,1	29,1	38,7	40,9	1	0,3	25,6	25,6	41,4	44,6	1	0,3	31,1	1,5	–		
29,1	29,1	38,7	40,9	1	0,3	25,6	25,6	41,4	44,6	1	0,3	31,1	1,5	–		
29,1	29,1	38,7	40,9	1	0,3	25,6	25,6	41,4	44,6	1	0,3	31,1	1,5	8,7		
29,1	29,1	38,7	40,9	1	0,3	25,6	25,6	41,4	44,6	1	0,3	31,1	1,5	8,7		

¹⁾ For calculating the initial grease fill → page 101

2.1 Angular contact ball bearings d 25 – 30 mm

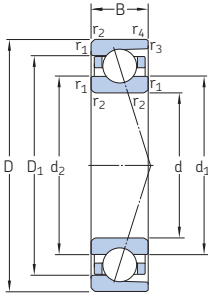

ACD, CD

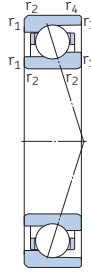

719 .. ACE,
719 .. CE

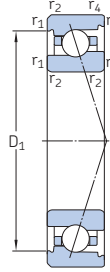

70 .. ACE,
70 .. CE

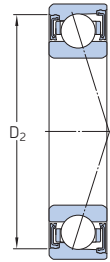

S... 1)

Principal dimensions	Basic load ratings		Fatigue load limit P_u	Attainable speeds		Mass ²⁾	Designation	Available variants			
	d	D		B	dynamic C			static C_0	Grease lubrication	Oil-air lubrication ²⁾	Sealing solution ¹⁾
mm	mm	mm	kN	kN	r/min	kg	–	–	–		
25	37	7	3,9	3,05	0,129	34 000	53 000	0,021	71805 ACD/P4	–	–
	37	7	3,9	3,05	0,129	40 000	63 000	0,019	71805 ACD/HCP4	–	–
	37	7	4,16	3,2	0,137	38 000	56 000	0,021	71805 CD/P4	–	–
	37	7	4,16	3,2	0,137	45 000	70 000	0,019	71805 CD/HCP4	–	–
	42	9	4,94	2,7	0,114	44 000	68 000	0,04	71905 ACE/P4A	S	H, L
	42	9	4,94	2,7	0,114	52 000	83 000	0,036	71905 ACE/HCP4A	S	H, L
	42	9	5,27	2,85	0,12	49 000	75 000	0,04	71905 CE/P4A	S	H, L
	42	9	5,27	2,85	0,12	58 000	90 000	0,036	71905 CE/HCP4A	S	H, L
	42	9	6,37	3,8	0,16	32 000	48 000	0,042	71905 ACD/P4A	S	–
	42	9	6,37	3,8	0,16	38 000	56 000	0,039	71905 ACD/HCP4A	S	–
	42	9	6,76	4	0,17	36 000	53 000	0,042	71905 CD/P4A	S	–
	42	9	6,76	4	0,17	45 000	63 000	0,039	71905 CD/HCP4A	S	–
	47	12	7,93	3,9	0,166	42 000	63 000	0,074	7005 ACE/P4A	S	H1, L, L1
	47	12	7,93	3,9	0,166	50 000	75 000	0,065	7005 ACE/HCP4A	S	H1, L, L1
	47	12	8,32	4,15	0,173	46 000	70 000	0,074	7005 CE/P4A	S	H1, L, L1
	47	12	8,32	4,15	0,173	56 000	85 000	0,065	7005 CE/HCP4A	S	H1, L, L1
47	12	9,23	5	0,212	34 000	50 000	0,079	7005 ACD/P4A	S	H	
47	12	9,23	5	0,212	40 000	60 000	0,07	7005 ACD/HCP4A	S	H	
47	12	9,56	5,2	0,22	36 000	56 000	0,079	7005 CD/P4A	S	H	
47	12	9,56	5,2	0,22	43 000	67 000	0,07	7005 CD/HCP4A	S	H	
52	15	13	6,95	0,29	26 000	40 000	0,13	7205 ACD/P4A	S	–	
52	15	13	6,95	0,29	32 000	48 000	0,11	7205 ACD/HCP4A	S	–	
52	15	13,5	7,2	0,305	30 000	45 000	0,13	7205 CD/P4A	S	–	
52	15	13,5	7,2	0,305	38 000	53 000	0,11	7205 CD/HCP4A	S	–	
30	42	7	4,16	3,55	0,15	28 000	45 000	0,026	71806 ACD/P4	–	–
	42	7	4,16	3,55	0,15	34 000	53 000	0,024	71806 ACD/HCP4	–	–
	42	7	4,42	3,75	0,16	32 000	50 000	0,026	71806 CD/P4	–	–
	42	7	4,42	3,75	0,16	38 000	60 000	0,024	71806 CD/HCP4	–	–

1) Designation prefix S. For details, refer to *Sealing solutions* (→ page 136).

2) Applicable to open bearings only.

3) Designation suffix H, H1, L or L1. For details, refer to *Direct oil-air lubrication* (→ page 136).

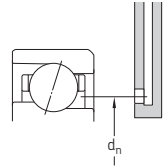
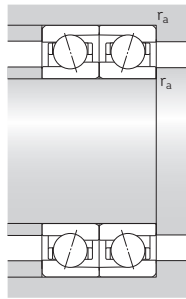
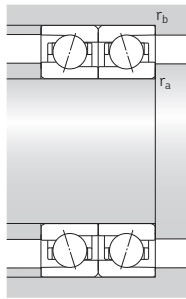
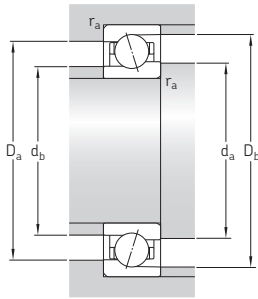

Dimensions					Abutment and fillet dimensions								Reference grease quantity ¹⁾	Calculation factor		
d	d ₁	d ₂	D ₁	D ₂	r _{1,2} min.	r _{3,4} min.	d _a min.	d _b min.	D _a max.	D _b max.	r _a max.	r _b max.	d _n	G _{ref}	f ₀	
mm															cm ³	–
25	29,1	29,1	33,1	–	0,3	0,15	27	27	35	36,2	0,3	0,15	29,5	0,21	–	
	29,1	29,1	33,1	–	0,3	0,15	27	27	35	36,2	0,3	0,15	29,5	0,21	–	
	29,1	29,1	33,1	–	0,3	0,15	27	27	35	36,2	0,3	0,15	29,5	0,21	16,4	
	29,1	29,1	33,1	–	0,3	0,15	27	27	35	36,2	0,3	0,15	29,5	0,21	16,4	
	30,7	29,4	36,4	38,4	0,3	0,15	27	27	40	41,2	0,3	0,15	31,8	0,6	–	
	30,7	29,4	36,4	38,4	0,3	0,15	27	27	40	41,2	0,3	0,15	31,8	0,6	–	
	30,7	29,4	36,4	38,4	0,3	0,15	27	27	40	41,2	0,3	0,15	31,8	0,6	8,1	
	30,7	29,4	36,4	38,4	0,3	0,15	27	27	40	41,2	0,3	0,15	31,8	0,6	8,1	
	30,6	30,6	36,4	39	0,3	0,2	27	27	40	40,6	0,3	0,2	31,8	0,54	–	
	30,6	30,6	36,4	39	0,3	0,2	27	27	40	40,6	0,3	0,2	31,8	0,54	–	
	30,6	30,6	36,4	39	0,3	0,2	27	27	40	40,6	0,3	0,2	31,8	0,54	10,2	
	30,6	30,6	36,4	39	0,3	0,2	27	27	40	40,6	0,3	0,2	31,8	0,54	10,2	
30	31,6	29,8	41,5	41,5	0,6	0,3	28,2	28,2	43,8	44,6	0,6	0,3	33,1	1,3	–	
	31,6	29,8	41,5	41,5	0,6	0,3	28,2	28,2	43,8	44,6	0,6	0,3	33,1	1,3	–	
	31,6	29,8	41,5	41,5	0,6	0,3	28,2	28,2	43,8	44,6	0,6	0,3	33,1	1,3	7,5	
	31,6	29,8	41,5	41,5	0,6	0,3	28,2	28,2	43,8	44,6	0,6	0,3	33,1	1,3	7,5	
	32,1	32,1	39,9	42,2	0,6	0,3	28,2	28,2	43,8	45	0,6	0,3	33,4	1	–	
	32,1	32,1	39,9	42,2	0,6	0,3	28,2	28,2	43,8	45	0,6	0,3	33,4	1	–	
	32,1	32,1	39,9	42,2	0,6	0,3	28,2	28,2	43,8	45	0,6	0,3	33,4	1	9,6	
	32,1	32,1	39,9	42,2	0,6	0,3	28,2	28,2	43,8	45	0,6	0,3	33,4	1	9,6	
	34,1	34,1	43,7	45,9	1	0,3	30,6	30,6	46,4	49,6	1	0,3	36,1	1,9	–	
	34,1	34,1	43,7	45,9	1	0,3	30,6	30,6	46,4	49,6	1	0,3	36,1	1,9	–	
	34,1	34,1	43,7	45,9	1	0,3	30,6	30,6	46,4	49,6	1	0,3	36,1	1,9	9,1	
	34,1	34,1	43,7	45,9	1	0,3	30,6	30,6	46,4	49,6	1	0,3	36,1	1,9	9,1	
30	34,1	34,1	38,1	–	0,3	0,15	32	32	40	41,2	0,3	0,15	34,5	0,24	–	
	34,1	34,1	38,1	–	0,3	0,15	32	32	40	41,2	0,3	0,15	34,5	0,24	–	
	34,1	34,1	38,1	–	0,3	0,15	32	32	40	41,2	0,3	0,15	34,5	0,24	16,8	
	34,1	34,1	38,1	–	0,3	0,15	32	32	40	41,2	0,3	0,15	34,5	0,24	16,8	

¹⁾ For calculating the initial grease fill → page 101

2.1 Angular contact ball bearings

d 30 mm

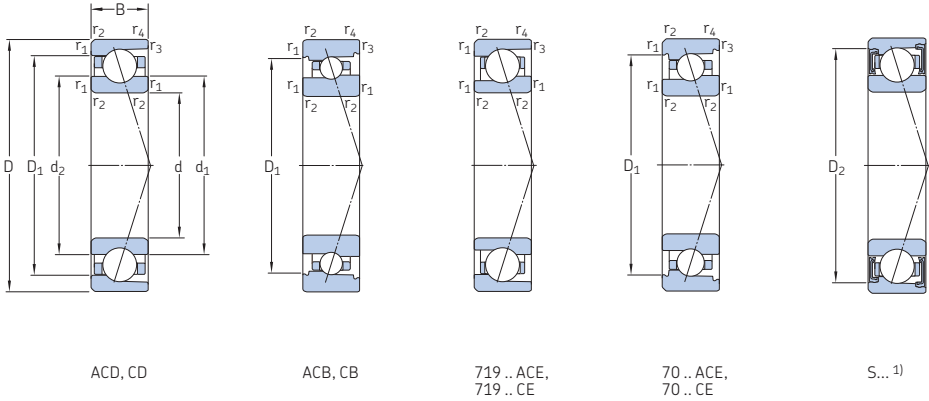

Principal dimensions	Basic load ratings		Fatigue load limit P_u	Attainable speeds		Mass ²⁾	Designation	Available variants			
	dynamic C	static C_0		Grease lubrication	Oil-air lubrication ²⁾			Sealing solution ¹⁾	Direct oil-air lubrication ³⁾		
d	D	B	kN	kN	r/min	kg	-	-	-		
mm	mm	mm	kN	kN	r/min	kg	-	-	-		
30 cont.	47	9	4,62	3	0,127	36 000	56 000	0,047	71906 ACB/P4A	S	-
	47	9	4,62	3	0,127	43 000	67 000	0,044	71906 ACB/HCP4A	S	-
	47	9	4,88	3,15	0,134	40 000	60 000	0,047	71906 CB/P4A	S	-
	47	9	4,88	3,15	0,134	48 000	75 000	0,044	71906 CB/HCP4A	S	-
	47	9	5,27	3,1	0,132	37 000	58 000	0,05	71906 ACE/P4A	S	H, L
	47	9	5,27	3,1	0,132	44 000	70 000	0,045	71906 ACE/HCP4A	S	H, L
	47	9	5,59	3,25	0,14	41 000	63 000	0,05	71906 CE/P4A	S	H, L
	47	9	5,59	3,25	0,14	49 000	75 000	0,045	71906 CE/HCP4A	S	H, L
	47	9	6,76	4,3	0,183	26 000	40 000	0,048	71906 ACD/P4A	S	-
	47	9	6,76	4,3	0,183	32 000	48 000	0,045	71906 ACD/HCP4A	S	-
	47	9	7,15	4,55	0,193	30 000	45 000	0,048	71906 CD/P4A	S	-
	47	9	7,15	4,55	0,193	38 000	53 000	0,045	71906 CD/HCP4A	S	-
55	13	6,18	3,9	0,166	34 000	50 000	0,13	7006 ACB/P4A	S	-	
55	13	6,18	3,9	0,166	40 000	60 000	0,13	7006 ACB/HCP4A	S	-	
55	13	6,5	4,15	0,176	36 000	56 000	0,13	7006 CB/P4A	S	-	
55	13	6,5	4,15	0,176	43 000	67 000	0,13	7006 CB/HCP4A	S	-	
55	13	8,84	5	0,212	35 000	54 000	0,11	7006 ACE/P4A	S	H1, L, L1	
55	13	8,84	5	0,212	42 000	65 000	0,1	7006 ACE/HCP4A	S	H1, L, L1	
55	13	9,36	5,2	0,22	39 000	60 000	0,11	7006 CE/P4A	S	H1, L, L1	
55	13	9,36	5,2	0,22	47 000	73 000	0,1	7006 CE/HCP4A	S	H1, L, L1	
55	13	13,8	7,65	0,325	28 000	43 000	0,11	7006 ACD/P4A	S	H	
55	13	13,8	7,65	0,325	34 000	53 000	0,095	7006 ACD/HCP4A	S	H	
55	13	14,3	8	0,34	32 000	48 000	0,11	7006 CD/P4A	S	H	
55	13	14,3	8	0,34	38 000	56 000	0,095	7006 CD/HCP4A	S	H	
62	16	23,4	15,3	0,64	20 000	34 000	0,2	7206 ACD/P4A	S	-	
62	16	23,4	15,3	0,64	26 000	40 000	0,17	7206 ACD/HCP4A	S	-	
62	16	24,2	16	0,67	24 000	38 000	0,2	7206 CD/P4A	S	-	
62	16	24,2	16	0,67	32 000	45 000	0,17	7206 CD/HCP4A	S	-	

1) Designation prefix S. For details, refer to *Sealing solutions* (→ page 136).

2) Applicable to open bearings only.

3) Designation suffix H, H1, L or L1. For details, refer to *Direct oil-air lubrication* (→ page 136).

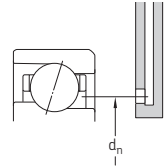
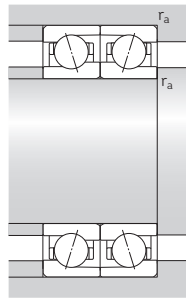
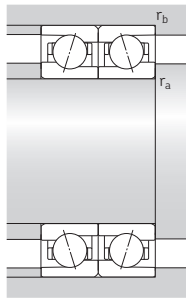
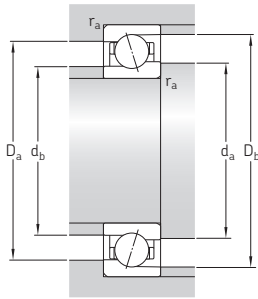

Dimensions					Abutment and fillet dimensions								Reference grease quantity ¹⁾	Calculation factor	
d	d ₁	d ₂	D ₁	D ₂	r _{1,2} min.	r _{3,4} min.	d _a min.	d _b min.	D _a max.	D _b max.	r _a max.	r _b max.	d _n	G _{ref}	f ₀
mm														cm ³	–
30 cont.	36	35,1	43	43	0,3	0,15	32	32	45	46,2	0,3	0,15	36,6	0,72	–
	36	35,1	43	43	0,3	0,15	32	32	45	46,2	0,3	0,15	36,6	0,72	–
	36	35,1	43	43	0,3	0,15	32	32	45	46,2	0,3	0,15	36,6	0,72	9,5
	36	35,1	43	43	0,3	0,15	32	32	45	46,2	0,3	0,15	36,6	0,72	9,5
	35,8	34,4	41,4	43,4	0,3	0,15	32	32	45	46,2	0,3	0,15	36,8	0,6	–
	35,8	34,4	41,4	43,4	0,3	0,15	32	32	45	46,2	0,3	0,15	36,8	0,6	–
	35,8	34,4	41,4	43,4	0,3	0,15	32	32	45	46,2	0,3	0,15	36,8	0,6	8,3
	35,8	34,4	41,4	43,4	0,3	0,15	32	32	45	46,2	0,3	0,15	36,8	0,6	8,3
	35,6	35,6	41,4	44	0,3	0,2	32	32	45	45,6	0,3	0,2	36,8	0,63	–
	35,6	35,6	41,4	44	0,3	0,2	32	32	45	45,6	0,3	0,2	36,8	0,63	–
	35,6	35,6	41,4	44	0,3	0,2	32	32	45	45,6	0,3	0,2	36,8	0,63	10,4
	35,6	35,6	41,4	44	0,3	0,2	32	32	45	45,6	0,3	0,2	36,8	0,63	10,4
	39,5	38,3	47,3	47,3	1	0,6	34,6	34,6	50,4	51,8	1	0,6	40	1,4	–
	39,5	38,3	47,3	47,3	1	0,6	34,6	34,6	50,4	51,8	1	0,6	40	1,4	–
	39,5	38,3	47,3	47,3	1	0,6	34,6	34,6	50,4	51,8	1	0,6	40	1,4	9,4
	39,5	38,3	47,3	47,3	1	0,6	34,6	34,6	50,4	51,8	1	0,6	40	1,4	9,4
	38,2	36,4	48,1	48,1	1	0,6	34,6	34,6	50,4	50,8	1	0,6	39,9	1,7	–
	38,2	36,4	48,1	48,1	1	0,6	34,6	34,6	50,4	50,8	1	0,6	39,9	1,7	–
	38,2	36,4	48,1	48,1	1	0,6	34,6	34,6	50,4	50,8	1	0,6	39,9	1,7	7,9
	38,2	36,4	48,1	48,1	1	0,6	34,6	34,6	50,4	50,8	1	0,6	39,9	1,7	7,9
	37,7	37,7	47,3	49,6	1	0,3	34,6	34,6	50,4	53	1	0,3	39,3	1,6	–
	37,7	37,7	47,3	49,6	1	0,3	34,6	34,6	50,4	53	1	0,3	39,3	1,6	–
	37,7	37,7	47,3	49,6	1	0,3	34,6	34,6	50,4	53	1	0,3	39,3	1,6	9,4
	37,7	37,7	47,3	49,6	1	0,3	34,6	34,6	50,4	53	1	0,3	39,3	1,6	9,4
	40,2	40,2	51,8	54	1	0,3	35,6	35,6	56,4	59,6	1	0,3	42,7	2,8	–
	40,2	40,2	51,8	54	1	0,3	35,6	35,6	56,4	59,6	1	0,3	42,7	2,8	–
	40,2	40,2	51,8	54	1	0,3	35,6	35,6	56,4	59,6	1	0,3	42,7	2,8	14
	40,2	40,2	51,8	54	1	0,3	35,6	35,6	56,4	59,6	1	0,3	42,7	2,8	14

¹⁾ For calculating the initial grease fill → page 101

2.1 Angular contact ball bearings

d 35 mm

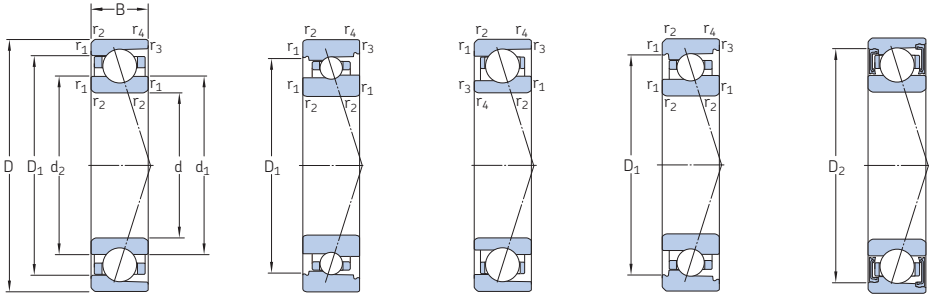

ACD, CD

ACB, CB

719 .. ACE,
719 .. CE

70 .. ACE,
70 .. CE

S... 1)

Principal dimensions			Basic load ratings		Fatigue load limit P_u	Attainable speeds		Mass ²⁾	Designation	Available variants	
d	D	B	dynamic C	static C_0		Grease lubrication	Oil-air lubrication ²⁾			Sealing solution ¹⁾	Direct oil-air lubrication ³⁾
mm			kN		kN	r/min		kg	-	-	
35	47	7	4,36	4,05	0,173	26 000	40 000	0,028	71807 ACD/P4	-	-
	47	7	4,36	4,05	0,173	30 000	48 000	0,026	71807 ACD/HCP4	-	-
	47	7	4,62	4,3	0,183	28 000	43 000	0,028	71807 CD/P4	-	-
	47	7	4,62	4,3	0,183	34 000	53 000	0,026	71807 CD/HCP4	-	-
55	10	4,88	3,45	0,146	30 000	48 000	0,078	71907 ACB/P4A	S	-	
	55	10	4,88	3,45	0,146	36 000	56 000	0,074	71907 ACB/HCP4A	S	-
	55	10	5,2	3,65	0,156	34 000	53 000	0,078	71907 CB/P4A	S	-
55	10	5,2	3,65	0,156	40 000	63 000	0,074	71907 CB/HCP4A	S	-	
55	10	7,28	4,5	0,19	32 000	50 000	0,075	71907 ACE/P4A	S	H, L	
	55	10	7,28	4,5	0,19	38 000	60 000	0,067	71907 ACE/HCP4A	S	H, L
	55	10	7,61	4,75	0,2	36 000	54 000	0,075	71907 CE/P4A	S	H, L
	55	10	7,61	4,75	0,2	43 000	65 000	0,067	71907 CE/HCP4A	S	H, L
55	10	9,23	6,2	0,26	22 000	36 000	0,074	71907 ACD/P4A	S	-	
	55	10	9,23	6,2	0,26	28 000	43 000	0,068	71907 ACD/HCP4A	S	-
	55	10	9,75	6,55	0,275	26 000	40 000	0,074	71907 CD/P4A	S	-
	55	10	9,75	6,55	0,275	32 000	45 000	0,068	71907 CD/HCP4A	S	-
62	14	6,5	4,55	0,193	28 000	43 000	0,17	7007 ACB/P4A	S	-	
	62	14	6,5	4,55	0,193	34 000	53 000	0,16	7007 ACB/HCP4A	S	-
	62	14	6,89	4,8	0,204	32 000	48 000	0,17	7007 CB/P4A	S	-
	62	14	6,89	4,8	0,204	38 000	60 000	0,16	7007 CB/HCP4A	S	-
62	14	11,1	6,3	0,265	31 000	46 000	0,15	7007 ACE/P4A	S	H1, L, L1	
	62	14	11,1	6,3	0,265	36 000	56 000	0,13	7007 ACE/HCP4A	S	H1, L, L1
	62	14	11,4	6,55	0,28	34 000	50 000	0,15	7007 CE/P4A	S	H1, L, L1
	62	14	11,4	6,55	0,28	40 000	63 000	0,13	7007 CE/HCP4A	S	H1, L, L1
62	14	14,8	9	0,38	20 000	32 000	0,15	7007 ACD/P4A	S	H	
	62	14	14,8	9	0,38	24 000	38 000	0,13	7007 ACD/HCP4A	S	H
	62	14	15,6	9,5	0,4	24 000	36 000	0,15	7007 CD/P4A	S	H
	62	14	15,6	9,5	0,4	28 000	43 000	0,13	7007 CD/HCP4A	S	H

1) Designation prefix S. For details, refer to *Sealing solutions* (→ page 136).

2) Applicable to open bearings only.

3) Designation suffix H, H1, L or L1. For details, refer to *Direct oil-air lubrication* (→ page 136).

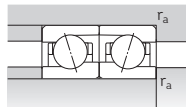
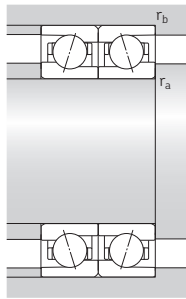
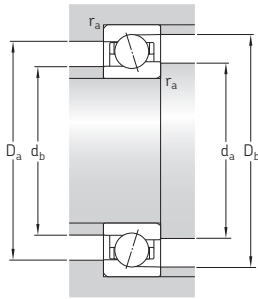

ACD, CD, ACB, CB,
70 .. ACE, 719 .. CE

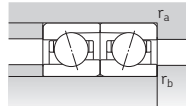
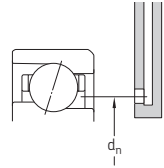

719 .. ACE, 719 .. CE

Dimensions					Abutment and fillet dimensions										Reference grease quantity ¹⁾	Calculation factor	
d	d ₁	d ₂	D ₁	D ₂	r _{1,2} min.	r _{3,4} min.	d _a min.	d _b min.	D _a max.	D _b max.	r _a max.	r _b max.	d _n	G _{ref}	f ₀		
mm																cm ³	-
35	39,1	39,1	43,1	-	0,3	0,15	37	37	45	46,2	0,3	0,15	39,5	0,28	-		
	39,1	39,1	43,1	-	0,3	0,15	37	37	45	46,2	0,3	0,15	39,5	0,28	-		
	39,1	39,1	43,1	-	0,3	0,15	37	37	45	46,2	0,3	0,15	39,5	0,28	17		
	39,1	39,1	43,1	-	0,3	0,15	37	37	45	46,2	0,3	0,15	39,5	0,28	17		
	42,5	41,6	49,5	49,5	0,6	0,3	38,2	38,2	51,8	53	0,6	0,3	43	0,96	-		
	42,5	41,6	49,5	49,5	0,6	0,3	38,2	38,2	51,8	53	0,6	0,3	43	0,96	-		
	42,5	41,6	49,5	49,5	0,6	0,3	38,2	38,2	51,8	53	0,6	0,3	43	0,96	9,7		
	42,5	41,6	49,5	49,5	0,6	0,3	38,2	38,2	51,8	53	0,6	0,3	43	0,96	9,7		
	41,7	40,2	48,3	50,3	0,6	0,3	38,2	37	51,8	53	0,6	0,3	43	0,8	-		
	41,7	40,2	48,3	50,3	0,6	0,3	38,2	37	51,8	53	0,6	0,3	43	0,8	-		
	41,7	40,2	48,3	50,3	0,6	0,3	38,2	37	51,8	53	0,6	0,3	43	0,8	8,3		
	41,7	40,2	48,3	50,3	0,6	0,3	38,2	37	51,8	53	0,6	0,3	43	0,8	8,3		
	41,6	41,6	48,4	50,1	0,6	0,3	38,2	38,2	51,8	53,6	0,6	0,3	43	0,93	-		
	41,6	41,6	48,4	50,1	0,6	0,3	38,2	38,2	51,8	53,6	0,6	0,3	43	0,93	-		
	41,6	41,6	48,4	50,1	0,6	0,3	38,2	38,2	51,8	53,6	0,6	0,3	43	0,93	10,4		
	41,6	41,6	48,4	50,1	0,6	0,3	38,2	38,2	51,8	53,6	0,6	0,3	43	0,93	10,4		
	45,5	44,3	53,4	53,4	1	0,6	39,6	39,6	57,4	58,8	1	0,6	46,1	1,8	-		
	45,5	44,3	53,4	53,4	1	0,6	39,6	39,6	57,4	58,8	1	0,6	46,1	1,8	-		
	45,5	44,3	53,4	53,4	1	0,6	39,6	39,6	57,4	58,8	1	0,6	46,1	1,8	9,6		
	45,5	44,3	53,4	53,4	1	0,6	39,6	39,6	57,4	58,8	1	0,6	46,1	1,8	9,6		
	43,7	41,6	54,9	54,9	1	0,6	39,6	39,6	57,4	57,8	1	0,6	45,6	2,4	-		
	43,7	41,6	54,9	54,9	1	0,6	39,6	39,6	57,4	57,8	1	0,6	45,6	2,4	-		
	43,7	41,6	54,9	54,9	1	0,6	39,6	39,6	57,4	57,8	1	0,6	45,6	2,4	7,9		
	43,7	41,6	54,9	54,9	1	0,6	39,6	39,6	57,4	57,8	1	0,6	45,6	2,4	7,9		
	43,7	43,7	53,3	55,6	1	0,3	39,6	39,6	57,4	60	1	0,3	45,3	2	-		
	43,7	43,7	53,3	55,6	1	0,3	39,6	39,6	57,4	60	1	0,3	45,3	2	-		
	43,7	43,7	53,3	55,6	1	0,3	39,6	39,6	57,4	60	1	0,3	45,3	2	9,7		
	43,7	43,7	53,3	55,6	1	0,3	39,6	39,6	57,4	60	1	0,3	45,3	2	9,7		

¹⁾ For calculating the initial grease fill → page 101

2.1 Angular contact ball bearings d 35 – 40 mm

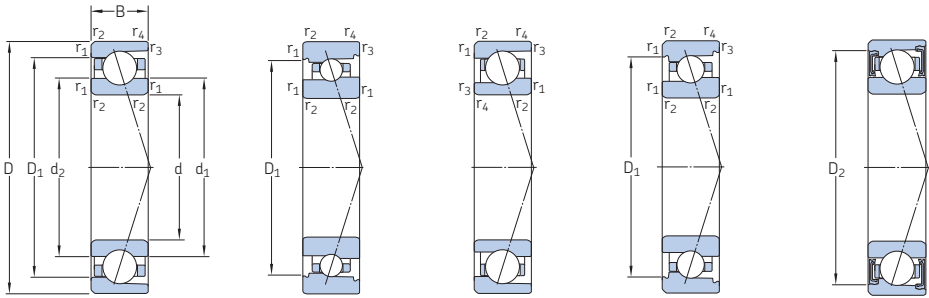

ACD, CD

ACB, CB

719 .. ACE,
719 .. CE70 .. ACE,
70 .. CE

S... 1)

Principal dimensions	Basic load ratings		Fatigue load limit P_u	Attainable speeds		Mass ²⁾	Designation	Available variants			
	dynamic C	static C_0		Grease lubrication	Oil-air lubrication ²⁾			Sealing solution ¹⁾	Direct oil-air lubrication ³⁾		
d	D	B	kN	kN	r/min	kg	-	-	-		
mm	mm	mm	kN	kN	r/min	kg	-	-	-		
35 cont.	72	17	30,7	20,8	0,88	18 000	30 000	0,29	7207 ACD/P4A	S	-
	72	17	30,7	20,8	0,88	20 000	34 000	0,24	7207 ACD/HCP4A	S	-
	72	17	31,9	21,6	0,915	20 000	34 000	0,29	7207 CD/P4A	S	-
	72	17	31,9	21,6	0,915	26 000	38 000	0,24	7207 CD/HCP4A	S	-
40	52	7	4,49	4,55	0,196	22 000	34 000	0,031	71808 ACD/P4	-	-
	52	7	4,49	4,55	0,196	28 000	43 000	0,029	71808 ACD/HCP4	-	-
	52	7	4,88	4,9	0,208	26 000	38 000	0,031	71808 CD/P4	-	-
	52	7	4,88	4,9	0,208	30 000	45 000	0,029	71808 CD/HCP4	-	-
	62	12	5,07	4	0,166	28 000	43 000	0,12	71908 ACB/P4A	S	L
	62	12	5,07	4	0,166	32 000	50 000	0,11	71908 ACB/HCP4A	S	L
	62	12	5,4	4,15	0,176	30 000	45 000	0,12	71908 CB/P4A	S	L
	62	12	5,4	4,15	0,176	36 000	56 000	0,11	71908 CB/HCP4A	S	L
	62	12	9,23	5,85	0,245	28 000	44 000	0,1	71908 ACE/P4A	S	H1, L
	62	12	9,23	5,85	0,245	34 000	52 000	0,088	71908 ACE/HCP4A	S	H1, L
	62	12	9,75	6,1	0,26	32 000	49 000	0,1	71908 CE/P4A	S	H1, L
	62	12	9,75	6,1	0,26	38 000	58 000	0,088	71908 CE/HCP4A	S	H1, L
	62	12	11,7	8	0,34	18 000	30 000	0,11	71908 ACD/P4A	S	-
	62	12	11,7	8	0,34	22 000	36 000	0,1	71908 ACD/HCP4A	S	-
	62	12	12,4	8,5	0,36	20 000	34 000	0,11	71908 CD/P4A	S	-
	62	12	12,4	8,5	0,36	28 000	40 000	0,1	71908 CD/HCP4A	S	-
68	15	6,89	5,3	0,224	26 000	40 000	0,21	7008 ACB/P4A	S	L	
68	15	6,89	5,3	0,224	32 000	48 000	0,2	7008 ACB/HCP4A	S	L	
68	15	7,41	5,6	0,236	28 000	43 000	0,21	7008 CB/P4A	S	L	
68	15	7,41	5,6	0,236	34 000	53 000	0,2	7008 CB/HCP4A	S	L	
68	15	11,7	7,2	0,305	27 000	41 000	0,19	7008 ACE/P4A	S	H1, L, L1	
68	15	11,7	7,2	0,305	32 000	50 000	0,17	7008 ACE/HCP4A	S	H1, L, L1	
68	15	12,4	7,65	0,32	30 000	45 000	0,19	7008 CE/P4A	S	H1, L, L1	
68	15	12,4	7,65	0,32	36 000	56 000	0,17	7008 CE/HCP4A	S	H1, L, L1	

1) Designation prefix S. For details, refer to *Sealing solutions* (→ page 136).

2) Applicable to open bearings only.

3) Designation suffix H, H1, L or L1. For details, refer to *Direct oil-air lubrication* (→ page 136).

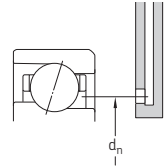
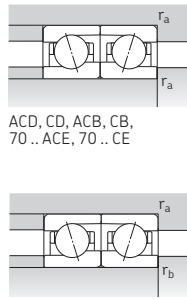
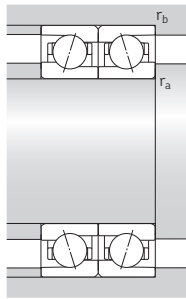
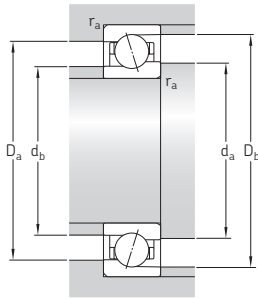

ACD, CD, ACB, CB,
70 .. ACE, 70 .. CE

719 .. ACE, 719 .. CE

Dimensions					Abutment and fillet dimensions								Reference grease quantity ¹⁾	Calculation factor		
d	d ₁	d ₂	D ₁	D ₂	r _{1,2} min.	r _{3,4} min.	d _a min.	d _b min.	D _a max.	D _b max.	r _a max.	r _b max.	d _n	G _{ref}	f ₀	
mm															cm ³	–
35 cont.	46,8	46,8	60,2	63,2	1,1	0,3	42	42	65	69,6	1	0,3	49,7	3,9	–	
	46,8	46,8	60,2	63,2	1,1	0,3	42	42	65	69,6	1	0,3	49,7	3,9	–	
	46,8	46,8	60,2	63,2	1,1	0,3	42	42	65	69,6	1	0,3	49,7	3,9	13,9	
	46,8	46,8	60,2	63,2	1,1	0,3	42	42	65	69,6	1	0,3	49,7	3,9	13,9	
40	44,1	44,1	48,1	–	0,3	0,15	42	42	50	51,2	0,3	0,15	44,5	0,31	–	
	44,1	44,1	48,1	–	0,3	0,15	42	42	50	51,2	0,3	0,15	44,5	0,31	–	
	44,1	44,1	48,1	–	0,3	0,15	42	42	50	51,2	0,3	0,15	44,5	0,31	17,2	
	44,1	44,1	48,1	–	0,3	0,15	42	42	50	51,2	0,3	0,15	44,5	0,31	17,2	
	48,5	47,6	55,6	55,6	0,6	0,3	43,2	43,2	58,8	60	0,6	0,3	49,1	1,4	–	
	48,5	47,6	55,6	55,6	0,6	0,3	43,2	43,2	58,8	60	0,6	0,3	49,1	1,4	–	
	48,5	47,6	55,6	55,6	0,6	0,3	43,2	43,2	58,8	60	0,6	0,3	49,1	1,4	9,8	
	48,5	47,6	55,6	55,6	0,6	0,3	43,2	43,2	58,8	60	0,6	0,3	49,1	1,4	9,8	
	46,5	44,8	54,2	56,5	0,6	0,3	43,2	42	58,8	60	0,6	0,3	48	1,4	–	
	46,5	44,8	54,2	56,5	0,6	0,3	43,2	42	58,8	60	0,6	0,3	48	1,4	–	
	46,5	44,8	54,2	56,5	0,6	0,3	43,2	42	58,8	60	0,6	0,3	48	1,4	8,3	
	46,5	44,8	54,2	56,5	0,6	0,3	43,2	42	58,8	60	0,6	0,3	48	1,4	8,3	
	47,1	47,1	54,9	57,1	0,6	0,3	43,2	43,2	58,8	60,6	0,6	0,3	48,7	1,4	–	
	47,1	47,1	54,9	57,1	0,6	0,3	43,2	43,2	58,8	60,6	0,6	0,3	48,7	1,4	–	
	47,1	47,1	54,9	57,1	0,6	0,3	43,2	43,2	58,8	60,6	0,6	0,3	48,7	1,4	10,4	
	47,1	47,1	54,9	57,1	0,6	0,3	43,2	43,2	58,8	60,6	0,6	0,3	48,7	1,4	10,4	
51	49,9	58,9	58,9	1	0,6	44,6	44,6	63,4	64,8	1	0,6	51,6	2,2	–		
51	49,9	58,9	58,9	1	0,6	44,6	44,6	63,4	64,8	1	0,6	51,6	2,2	–		
51	49,9	58,9	58,9	1	0,6	44,6	44,6	63,4	64,8	1	0,6	51,6	2,2	9,8		
51	49,9	58,9	58,9	1	0,6	44,6	44,6	63,4	64,8	1	0,6	51,6	2,2	9,8		
49,7	47,6	60,9	60,9	1	0,6	44,6	44,6	63,4	63,8	1	0,6	51,6	2,8	–		
49,7	47,6	60,9	60,9	1	0,6	44,6	44,6	63,4	63,8	1	0,6	51,6	2,8	–		
49,7	47,6	60,9	60,9	1	0,6	44,6	44,6	63,4	63,8	1	0,6	51,6	2,8	8,1		
49,7	47,6	60,9	60,9	1	0,6	44,6	44,6	63,4	63,8	1	0,6	51,6	2,8	8,1		

¹⁾ For calculating the initial grease fill → page 101

2.1 Angular contact ball bearings d 40 – 45 mm

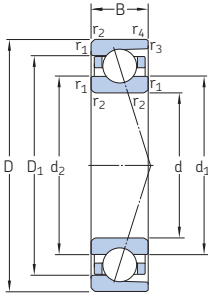

ACD, CD

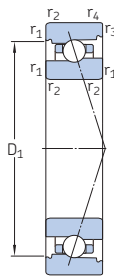

ACB, CB

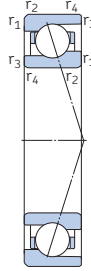

719 .. ACE,
719 .. CE

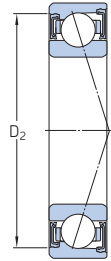

S... 1)

Principal dimensions	Basic load ratings		Fatigue load limit P_u	Attainable speeds		Mass ²⁾	Designation	Available variants			
	dynamic C	static C_0		Grease lubrication	Oil-air lubrication ²⁾			Sealing solution ¹⁾	Direct oil-air lubrication ³⁾		
d D B	kN		kN	r/min		kg	-	-			
mm	kN		kN	r/min		kg	-	-			
40 cont.	68	15	15,9	10,4	0,44	19 000	30 000	0,19	7008 ACD/P4A	S	H
	68	15	15,9	10,4	0,44	22 000	34 000	0,17	7008 ACD/HCP4A	S	H
	68	15	16,8	11	0,465	20 000	32 000	0,19	7008 CD/P4A	S	H
	68	15	16,8	11	0,465	24 000	38 000	0,17	7008 CD/HCP4A	S	H
	80	18	31,9	22,8	0,98	16 000	26 000	0,37	7208 ACD/P4A	S	-
	80	18	31,9	22,8	0,98	19 000	32 000	0,33	7208 ACD/HCP4A	S	-
	80	18	33,8	24	1,02	18 000	30 000	0,37	7208 CD/P4A	S	-
	80	18	33,8	24	1,02	22 000	34 000	0,33	7208 CD/HCP4A	S	-
45	58	7	4,62	5	0,212	20 000	30 000	0,039	71809 ACD/P4	-	-
	58	7	4,62	5	0,212	24 000	38 000	0,037	71809 ACD/HCP4	-	-
	58	7	4,88	5,3	0,224	22 000	34 000	0,039	71809 CD/P4	-	-
	58	7	4,88	5,3	0,224	26 000	40 000	0,037	71809 CD/HCP4	-	-
	68	12	7,02	5,4	0,232	24 000	38 000	0,13	71909 ACB/P4A	S	L
	68	12	7,02	5,4	0,232	30 000	45 000	0,13	71909 ACB/HCP4A	S	L
	68	12	7,41	5,7	0,245	28 000	43 000	0,13	71909 CB/P4A	S	L
	68	12	7,41	5,7	0,245	32 000	50 000	0,13	71909 CB/HCP4A	S	L
	68	12	9,75	6,55	0,275	25 000	39 000	0,13	71909 ACE/P4A	S	H1, L
	68	12	9,75	6,55	0,275	30 000	47 000	0,12	71909 ACE/HCP4A	S	H1, L
	68	12	10,1	6,95	0,29	29 000	44 000	0,13	71909 CE/P4A	S	H1, L
	68	12	10,1	6,95	0,29	34 000	52 000	0,12	71909 CE/HCP4A	S	H1, L
	68	12	12,4	9	0,38	17 000	28 000	0,13	71909 ACD/P4A	S	-
	68	12	12,4	9	0,38	20 000	34 000	0,12	71909 ACD/HCP4A	S	-
	68	12	13	9,5	0,4	19 000	32 000	0,13	71909 CD/P4A	S	-
	68	12	13	9,5	0,4	24 000	36 000	0,12	71909 CD/HCP4A	S	-
75	16	9,04	6,8	0,285	24 000	36 000	0,26	7009 ACB/P4A	S	L	
75	16	9,04	6,8	0,285	28 000	43 000	0,25	7009 ACB/HCP4A	S	L	
75	16	9,56	7,2	0,305	26 000	40 000	0,26	7009 CB/P4A	S	L	
75	16	9,56	7,2	0,305	30 000	48 000	0,25	7009 CB/HCP4A	S	L	

1) Designation prefix S. For details, refer to *Sealing solutions* (→ page 136).

2) Applicable to open bearings only.

3) Designation suffix H, H1, L or L1. For details, refer to *Direct oil-air lubrication* (→ page 136).

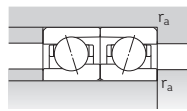
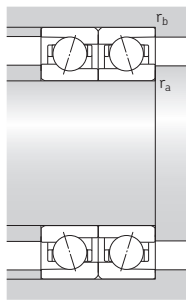
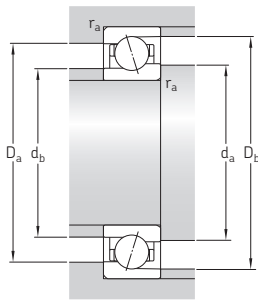

ACD, CD, ACB, CB

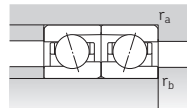

719 .. ACE, 719 .. CE

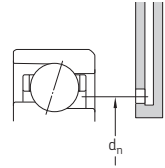

Dimensions					Abutment and fillet dimensions								Reference grease quantity ¹⁾	Calculation factor		
d	d ₁	d ₂	D ₁	D ₂	r _{1,2} min.	r _{3,4} min.	d _a min.	d _b min.	D _a max.	D _b max.	r _a max.	r _b max.	d _n	G _{ref}	f ₀	
mm															cm ³	–
40 cont.	49,2	49,2	58,8	61	1	0,3	44,6	44,6	63,4	66	1	0,3	50,8	2,4	–	
	49,2	49,2	58,8	61	1	0,3	44,6	44,6	63,4	66	1	0,3	50,8	2,4	–	
	49,2	49,2	58,8	61	1	0,3	44,6	44,6	63,4	66	1	0,3	50,8	2,4	10	
	49,2	49,2	58,8	61	1	0,3	44,6	44,6	63,4	66	1	0,3	50,8	2,4	10	
45	53,3	53,3	66,7	69,7	1,1	0,6	47	47	73	75,8	1	0,6	56,2	4,7	–	
	53,3	53,3	66,7	69,7	1,1	0,6	47	47	73	75,8	1	0,6	56,2	4,7	–	
	53,3	53,3	66,7	69,7	1,1	0,6	47	47	73	75,8	1	0,6	56,2	4,7	14,4	
	53,3	53,3	66,7	69,7	1,1	0,6	47	47	73	75,8	1	0,6	56,2	4,7	14,4	
	49,6	49,6	53,6	–	0,3	0,15	47	47	56	57,2	0,3	0,15	50	0,36	–	
	49,6	49,6	53,6	–	0,3	0,15	47	47	56	57,2	0,3	0,15	50	0,36	–	
	49,6	49,6	53,6	–	0,3	0,15	47	47	56	57,2	0,3	0,15	50	0,36	17,4	
	49,6	49,6	53,6	–	0,3	0,15	47	47	56	57,2	0,3	0,15	50	0,36	17,4	
	53,5	52,4	61,8	61,8	0,6	0,3	48,2	48,2	64,8	66	0,6	0,3	54,2	1,8	–	
	53,5	52,4	61,8	61,8	0,6	0,3	48,2	48,2	64,8	66	0,6	0,3	54,2	1,8	–	
	53,5	52,4	61,8	61,8	0,6	0,3	48,2	48,2	64,8	66	0,6	0,3	54,2	1,8	9,7	
	53,5	52,4	61,8	61,8	0,6	0,3	48,2	48,2	64,8	66	0,6	0,3	54,2	1,8	9,7	
52,7	51	60,3	62,6	0,6	0,3	48,2	47	64,8	66	0,6	0,3	54,2	1,5	–		
52,7	51	60,3	62,6	0,6	0,3	48,2	47	64,8	66	0,6	0,3	54,2	1,5	–		
52,7	51	60,3	62,6	0,6	0,3	48,2	47	64,8	66	0,6	0,3	54,2	1,5	8,4		
52,7	51	60,3	62,6	0,6	0,3	48,2	47	64,8	66	0,6	0,3	54,2	1,5	8,4		
52,6	52,6	60,4	62,6	0,6	0,3	48,2	48,2	64,8	66,6	0,6	0,3	54,2	1,6	–		
52,6	52,6	60,4	62,6	0,6	0,3	48,2	48,2	64,8	66,6	0,6	0,3	54,2	1,6	–		
52,6	52,6	60,4	62,6	0,6	0,3	48,2	48,2	64,8	66,6	0,6	0,3	54,2	1,6	10,5		
52,6	52,6	60,4	62,6	0,6	0,3	48,2	48,2	64,8	66,6	0,6	0,3	54,2	1,6	10,5		
56,4	55,2	65,6	65,6	1	0,6	49,6	49,6	70,4	71,8	1	0,6	57,2	2,9	–		
56,4	55,2	65,6	65,6	1	0,6	49,6	49,6	70,4	71,8	1	0,6	57,2	2,9	–		
56,4	55,2	65,6	65,6	1	0,6	49,6	49,6	70,4	71,8	1	0,6	57,2	2,9	9,6		
56,4	55,2	65,6	65,6	1	0,6	49,6	49,6	70,4	71,8	1	0,6	57,2	2,9	9,6		

¹⁾ For calculating the initial grease fill → page 101

2.1 Angular contact ball bearings

d 45 – 50 mm

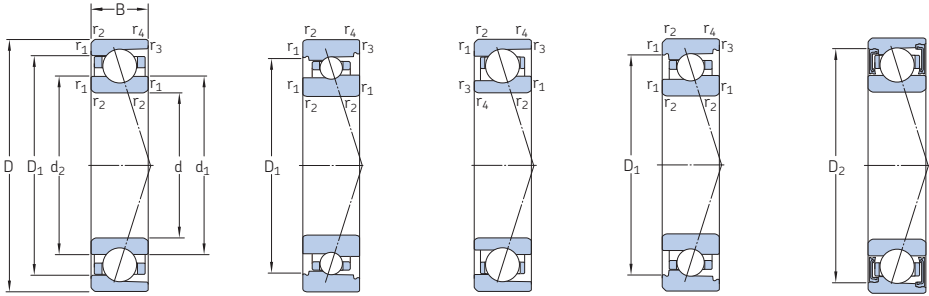

ACD, CD

ACB, CB

719 .. ACE,
719 .. CE70 .. ACE,
70 .. CE

S... 1)

Principal dimensions	Basic load ratings		Fatigue load limit P_u	Attainable speeds		Mass ²⁾	Designation	Available variants			
	dynamic C	static C_0		Grease lubrication	Oil-air lubrication ²⁾			Sealing solution ¹⁾	Direct oil-air lubrication ³⁾		
d	D	B									
mm			kN	kN	r/min	kg	–	–			
45 cont.	75	16	12,1	8,15	0,345	24 000	37 000	0,24	7009 ACE/P4A	S	H1, L, L1
	75	16	12,1	8,15	0,345	29 000	45 000	0,22	7009 ACE/HCP4A	S	H1, L, L1
	75	16	13	8,5	0,36	27 000	41 000	0,24	7009 CE/P4A	S	H1, L, L1
	75	16	13	8,5	0,36	32 000	50 000	0,22	7009 CE/HCP4A	S	H1, L, L1
	75	16	27,6	21,6	0,9	17 000	26 000	0,24	7009 ACD/P4A	S	H
	75	16	27,6	21,6	0,9	20 000	32 000	0,2	7009 ACD/HCP4A	S	H
	75	16	28,6	22,4	0,95	19 000	30 000	0,24	7009 CD/P4A	S	H
	75	16	28,6	22,4	0,95	22 000	34 000	0,2	7009 CD/HCP4A	S	H
	85	19	41	30	1,25	15 000	24 000	0,41	7209 ACD/P4A	S	–
	85	19	41	30	1,25	17 000	28 000	0,34	7209 ACD/HCP4A	S	–
	85	19	42,3	31	1,32	17 000	28 000	0,41	7209 CD/P4A	S	–
	85	19	42,3	31	1,32	20 000	32 000	0,34	7209 CD/HCP4A	S	–
50	65	7	6,89	7,35	0,315	18 000	28 000	0,051	71810 ACD/P4	–	–
	65	7	6,89	7,35	0,315	22 000	34 000	0,046	71810 ACD/HCP4	–	–
	65	7	7,41	7,8	0,335	20 000	30 000	0,051	71810 CD/P4	–	–
	65	7	7,41	7,8	0,335	24 000	36 000	0,046	71810 CD/HCP4	–	–
	72	12	7,28	5,85	0,25	22 000	36 000	0,13	71910 ACB/P4A	S	L
	72	12	7,28	5,85	0,25	28 000	43 000	0,13	71910 ACB/HCP4A	S	L
	72	12	7,61	6,2	0,265	26 000	38 000	0,13	71910 CB/P4A	S	L
	72	12	7,61	6,2	0,265	30 000	45 000	0,13	71910 CB/HCP4A	S	L
	72	12	12,1	8,15	0,345	23 000	36 000	0,13	71910 ACE/P4A	S	H1, L
	72	12	12,1	8,15	0,345	28 000	43 000	0,11	71910 ACE/HCP4A	S	H1, L
	72	12	12,7	8,65	0,365	26 000	40 000	0,13	71910 CE/P4A	S	H1, L
	72	12	12,7	8,65	0,365	32 000	48 000	0,11	71910 CE/HCP4A	S	H1, L
	72	12	12,7	9,8	0,415	16 000	26 000	0,13	71910 ACD/P4A	S	–
	72	12	12,7	9,8	0,415	19 000	30 000	0,12	71910 ACD/HCP4A	S	–
	72	12	13,5	10,4	0,44	17 000	28 000	0,13	71910 CD/P4A	S	–
	72	12	13,5	10,4	0,44	22 000	34 000	0,12	71910 CD/HCP4A	S	–

1) Designation prefix S. For details, refer to *Sealing solutions* (→ page 136).

2) Applicable to open bearings only.

3) Designation suffix H, H1, L or L1. For details, refer to *Direct oil-air lubrication* (→ page 136).

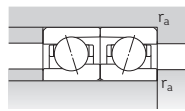
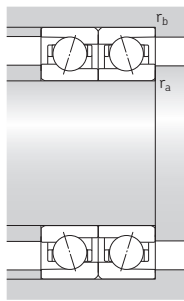
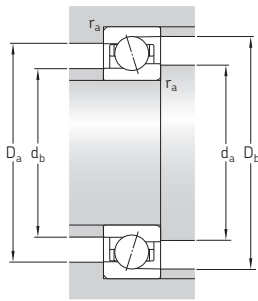

ACD, CD, ACB, CB,
70 .. ACE, 70 .. CE

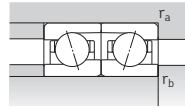
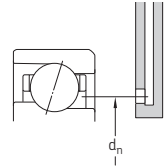

719 .. ACE, 719 .. CE

Dimensions					Abutment and fillet dimensions										Reference grease quantity ¹⁾	Calculation factor
d	d ₁	d ₂	D ₁	D ₂	r _{1,2} min.	r _{3,4} min.	d _a min.	d _b min.	D _a max.	D _b max.	r _a max.	r _b max.	d _n	G _{ref}	f ₀	
mm															cm ³	–
45 cont.	55,7	53,6	66,9	66,9	1	0,6	49,6	49,6	70,4	70,8	1	0,6	57,6	3,4	–	
	55,7	53,6	66,9	66,9	1	0,6	49,6	49,6	70,4	70,8	1	0,6	57,6	3,4	–	
	55,7	53,6	66,9	66,9	1	0,6	49,6	49,6	70,4	70,8	1	0,6	57,6	3,4	8,2	
	55,7	53,6	66,9	66,9	1	0,6	49,6	49,6	70,4	70,8	1	0,6	57,6	3,4	8,2	
	54,2	54,2	65,8	68,3	1	0,3	49,6	49,6	70,4	73	1	0,3	56,2	3,3	–	
	54,2	54,2	65,8	68,3	1	0,3	49,6	49,6	70,4	73	1	0,3	56,2	3,3	–	
	54,2	54,2	65,8	68,3	1	0,3	49,6	49,6	70,4	73	1	0,3	56,2	3,3	15,1	
	54,2	54,2	65,8	68,3	1	0,3	49,6	49,6	70,4	73	1	0,3	56,2	3,3	15,1	
	57,3	57,3	72,7	75,7	1,1	0,6	52	52	78	80,8	1	0,6	60,6	5,9	–	
	57,3	57,3	72,7	75,7	1,1	0,6	52	52	78	80,8	1	0,6	60,6	5,9	–	
	57,3	57,3	72,7	75,7	1,1	0,6	52	52	78	80,8	1	0,6	60,6	5,9	14,2	
	57,3	57,3	72,7	75,7	1,1	0,6	52	52	78	80,8	1	0,6	60,6	5,9	14,2	
50	55,1	55,1	60	–	0,3	0,15	52	52	63	64,2	0,3	0,15	55,6	0,5	–	
	55,1	55,1	60	–	0,3	0,15	52	52	63	64,2	0,3	0,15	55,6	0,5	–	
	55,1	55,1	60	–	0,3	0,15	52	52	63	64,2	0,3	0,15	55,6	0,5	17,2	
	55,1	55,1	60	–	0,3	0,15	52	52	63	64,2	0,3	0,15	55,6	0,5	17,2	
	58	56,9	66	66	0,6	0,3	53,2	53,2	68,8	70	0,6	0,3	58,7	1,9	–	
	58	56,9	66	66	0,6	0,3	53,2	53,2	68,8	70	0,6	0,3	58,7	1,9	–	
	58	56,9	66	66	0,6	0,3	53,2	53,2	68,8	70	0,6	0,3	58,7	1,9	9,8	
	58	56,9	66	66	0,6	0,3	53,2	53,2	68,8	70	0,6	0,3	58,7	1,9	9,8	
	56,7	54,9	65,3	67,7	0,6	0,3	53,2	52	68,8	70	0,6	0,3	58,4	1,7	–	
	56,7	54,9	65,3	67,7	0,6	0,3	53,2	52	68,8	70	0,6	0,3	58,4	1,7	–	
	56,7	54,9	65,3	67,7	0,6	0,3	53,2	52	68,8	70	0,6	0,3	58,4	1,7	8,4	
	56,7	54,9	65,3	67,7	0,6	0,3	53,2	52	68,8	70	0,6	0,3	58,4	1,7	8,4	
	57,1	57,1	64,9	67,1	0,6	0,3	53,2	53,2	68,8	70,6	0,6	0,3	58,7	1,7	–	
	57,1	57,1	64,9	67,1	0,6	0,3	53,2	53,2	68,8	70,6	0,6	0,3	58,7	1,7	–	
	57,1	57,1	64,9	67,1	0,6	0,3	53,2	53,2	68,8	70,6	0,6	0,3	58,7	1,7	10,7	
	57,1	57,1	64,9	67,1	0,6	0,3	53,2	53,2	68,8	70,6	0,6	0,3	58,7	1,7	10,7	

¹⁾ For calculating the initial grease fill → page 101

2.1 Angular contact ball bearings

d 50 – 55 mm

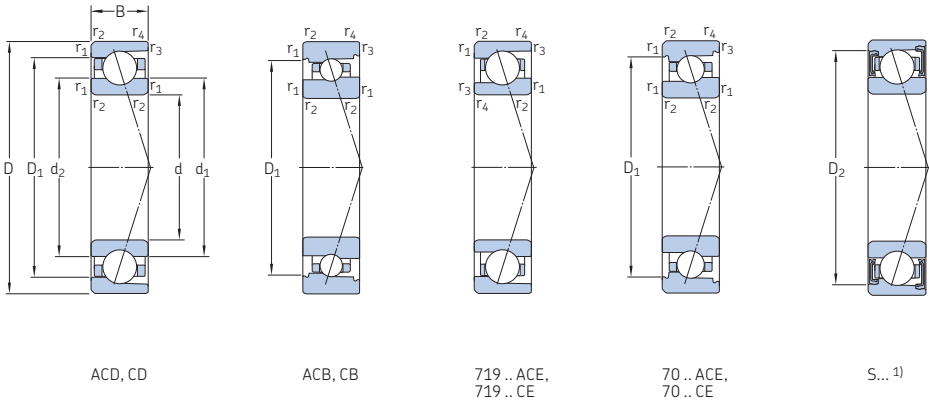

Principal dimensions	Basic load ratings		Fatigue load limit P_u	Attainable speeds		Mass ²⁾	Designation	Available variants			
	dynamic C	static C_0		Grease lubrication	Oil-air lubrication ²⁾			Sealing solution ¹⁾	Direct oil-air lubrication ³⁾		
d	D	B	kN	kN	r/min	kg	–	–	–		
mm	mm	mm	kN	kN	r/min	kg	–	–	–		
50 cont.	80	16	9,36	7,35	0,31	22 000	32 000	0,29	7010 ACB/P4A	S	L
	80	16	9,36	7,35	0,31	26 000	40 000	0,28	7010 ACB/HCP4A	S	L
	80	16	9,95	7,8	0,335	24 000	36 000	0,29	7010 CB/P4A	S	L
	80	16	9,95	7,8	0,335	28 000	45 000	0,28	7010 CB/HCP4A	S	L
	80	16	14,8	10	0,425	23 000	34 000	0,25	7010 ACE/P4A	S	H1, L, L1
	80	16	14,8	10	0,425	27 000	41 000	0,23	7010 ACE/HCP4A	S	H1, L, L1
	80	16	15,6	10,6	0,45	25 000	38 000	0,25	7010 CE/P4A	S	H1, L, L1
	80	16	15,6	10,6	0,45	30 000	46 000	0,23	7010 CE/HCP4A	S	H1, L, L1
	80	16	28,1	23,2	0,98	15 000	24 000	0,25	7010 ACD/P4A	S	H, L
	80	16	28,1	23,2	0,98	18 000	28 000	0,22	7010 ACD/HCP4A	S	H, L
	80	16	29,6	24	1,02	17 000	28 000	0,25	7010 CD/P4A	S	H, L
	80	16	29,6	24	1,02	20 000	32 000	0,22	7010 CD/HCP4A	S	H, L
55	72	9	9,56	10,2	0,43	16 000	24 000	0,081	71811 ACD/P4	–	–
	72	9	9,56	10,2	0,43	19 000	30 000	0,073	71811 ACD/HCP4	–	–
	72	9	10,1	10,8	0,455	18 000	28 000	0,081	71811 CD/P4	–	–
	72	9	10,1	10,8	0,455	22 000	32 000	0,073	71811 CD/HCP4	–	–
	80	13	9,36	7,65	0,325	20 000	32 000	0,18	71911 ACB/P4A	S	L
	80	13	9,36	7,65	0,325	24 000	38 000	0,17	71911 ACB/HCP4A	S	L
	80	13	9,95	8,15	0,345	22 000	34 000	0,18	71911 CB/P4A	S	L
	80	13	9,95	8,15	0,345	28 000	43 000	0,17	71911 CB/HCP4A	S	L
	80	13	14,6	10,2	0,43	21 000	32 000	0,17	71911 ACE/P4A	S	H1, L
	80	13	14,6	10,2	0,43	25 000	39 000	0,14	71911 ACE/HCP4A	S	H1, L
	80	13	15,3	10,6	0,455	24 000	36 000	0,17	71911 CE/P4A	S	H1, L
	80	13	15,3	10,6	0,455	28 000	43 000	0,14	71911 CE/HCP4A	S	H1, L

1) Designation prefix S. For details, refer to *Sealing solutions* (→ page 136).

2) Applicable to open bearings only.

3) Designation suffix H, H1, L or L1. For details, refer to *Direct oil-air lubrication* (→ page 136).

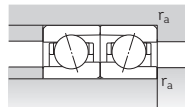
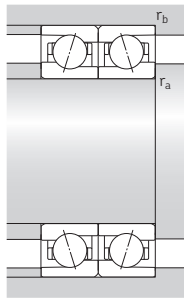
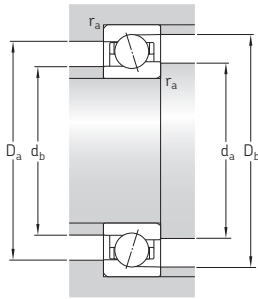

ACD, CD, ACB, CB,
70 .. ACE, 70 .. CE

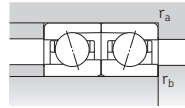

719 .. ACE, 719 .. CE

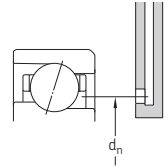

Dimensions					Abutment and fillet dimensions								Reference grease quantity ¹⁾	Calculation factor	
d	d ₁	d ₂	D ₁	D ₂	r _{1,2} min.	r _{3,4} min.	d _a min.	d _b min.	D _a max.	D _b max.	r _a max.	r _b max.	d _n	G _{ref}	f ₀
mm														cm ³	–
50 cont.	61.4	59.7	70.7	70.7	1	0,6	54,6	54,6	75,4	76,8	1	0,6	61,8	3,1	–
	61.4	59.7	70.7	70.7	1	0,6	54,6	54,6	75,4	76,8	1	0,6	61,8	3,1	–
	61.4	59.7	70.7	70.7	1	0,6	54,6	54,6	75,4	76,8	1	0,6	61,8	3,1	9,7
	61.4	59.7	70.7	70.7	1	0,6	54,6	54,6	75,4	76,8	1	0,6	61,8	3,1	9,7
	60.3	57.9	72.9	72.9	1	0,6	54,6	54,6	75,4	75,8	1	0,6	62,3	4,1	–
	60.3	57.9	72.9	72.9	1	0,6	54,6	54,6	75,4	75,8	1	0,6	62,3	4,1	–
	60.3	57.9	72.9	72.9	1	0,6	54,6	54,6	75,4	75,8	1	0,6	62,3	4,1	8,2
	60.3	57.9	72.9	72.9	1	0,6	54,6	54,6	75,4	75,8	1	0,6	62,3	4,1	8,2
	59.2	59.2	70.8	73.3	1	0,3	54,6	54,6	75,4	78	1	0,3	61,2	3,6	–
	59.2	59.2	70.8	73.3	1	0,3	54,6	54,6	75,4	78	1	0,3	61,2	3,6	–
	59.2	59.2	70.8	73.3	1	0,3	54,6	54,6	75,4	78	1	0,3	61,2	3,6	15,4
	59.2	59.2	70.8	73.3	1	0,3	54,6	54,6	75,4	78	1	0,3	61,2	3,6	15,4
55	62.3	62.3	77.7	80.7	1,1	0,6	57	57	83	85.8	1	0,6	65,6	6,7	–
	62.3	62.3	77.7	80.7	1,1	0,6	57	57	83	85.8	1	0,6	65,6	6,7	–
	62.3	62.3	77.7	80.7	1,1	0,6	57	57	83	85.8	1	0,6	65,6	6,7	14,5
	62.3	62.3	77.7	80.7	1,1	0,6	57	57	83	85.8	1	0,6	65,6	6,7	14,5
	60.7	60.7	66.5	–	0,3	0,15	57	57	70	71.2	0,3	0,15	61,3	0,88	–
	60.7	60.7	66.5	–	0,3	0,15	57	57	70	71.2	0,3	0,15	61,3	0,88	–
	60.7	60.7	66.5	–	0,3	0,15	57	57	70	71.2	0,3	0,15	61,3	0,88	17,1
	60.7	60.7	66.5	–	0,3	0,15	57	57	70	71.2	0,3	0,15	61,3	0,88	17,1
	63.9	62.7	73.2	73.2	1	0,3	59,6	59,6	75,4	78	1	0,3	64,8	2,6	–
	63.9	62.7	73.2	73.2	1	0,3	59,6	59,6	75,4	78	1	0,3	64,8	2,6	–
	63.9	62.7	73.2	73.2	1	0,3	59,6	59,6	75,4	78	1	0,3	64,8	2,6	9,8
	63.9	62.7	73.2	73.2	1	0,3	59,6	59,6	75,4	78	1	0,3	64,8	2,6	9,8
62.8	60.7	72.3	74.7	1	0,3	59,6	57	75,4	78	1	0,3	64,6	2,3	–	
62.8	60.7	72.3	74.7	1	0,3	59,6	57	75,4	78	1	0,3	64,6	2,3	–	
62.8	60.7	72.3	74.7	1	0,3	59,6	57	75,4	78	1	0,3	64,6	2,3	8,4	
62.8	60.7	72.3	74.7	1	0,3	59,6	57	75,4	78	1	0,3	64,6	2,3	8,4	

¹⁾ For calculating the initial grease fill → page 101

2.1 Angular contact ball bearings d 55 – 60 mm

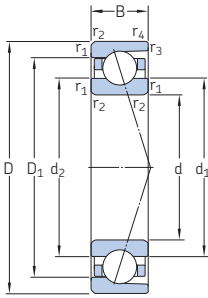

ACD, CD

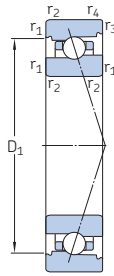

ACB, CB

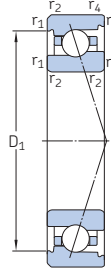

70 .. ACE,
70 .. CE

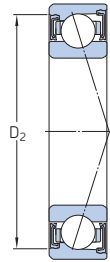

S... 1)

Principal dimensions	Basic load ratings		Fatigue load limit P_u	Attainable speeds		Mass ²⁾	Designation	Available variants			
	dynamic C	static C_0		Grease lubrication	Oil-air lubrication ²⁾			Sealing solution ¹⁾	Direct oil-air lubrication ³⁾		
d D B	kN		kN	r/min		kg	-	-			
mm	kN		kN	r/min		kg	-	-			
55 cont.	80	13	18,2	13,7	0,585	15 000	24 000	0,18	71911 ACD/P4A	S	L
	80	13	18,2	13,7	0,585	17 000	28 000	0,15	71911 ACD/HCP4A	S	L
	80	13	19,5	14,6	0,62	16 000	26 000	0,18	71911 CD/P4A	S	L
	80	13	19,5	14,6	0,62	19 000	30 000	0,15	71911 CD/HCP4A	S	L
	90	18	13,3	10,4	0,44	19 000	30 000	0,42	7011 ACB/P4A	S	L
	90	18	13,3	10,4	0,44	24 000	36 000	0,4	7011 ACB/HCP4A	S	L
	90	18	14	11	0,465	22 000	32 000	0,42	7011 CB/P4A	S	L
	90	18	14	11	0,465	26 000	40 000	0,4	7011 CB/HCP4A	S	L
	90	18	15,9	11,6	0,49	19 000	30 000	0,39	7011 ACE/P4A	S	H1, L, L1
	90	18	15,9	11,6	0,49	23 000	35 000	0,36	7011 ACE/HCP4A	S	H1, L, L1
	90	18	16,8	12,2	0,52	22 000	34 000	0,39	7011 CE/P4A	S	H1, L, L1
	90	18	16,8	12,2	0,52	25 000	39 000	0,36	7011 CE/HCP4A	S	H1, L, L1
90	18	37,1	31	1,32	14 000	22 000	0,38	7011 ACD/P4A	S	H1, L	
90	18	37,1	31	1,32	17 000	26 000	0,32	7011 ACD/HCP4A	S	H1, L	
90	18	39,7	32,5	1,37	15 000	24 000	0,38	7011 CD/P4A	S	H1, L	
90	18	39,7	32,5	1,37	18 000	28 000	0,32	7011 CD/HCP4A	S	H1, L	
100	21	52,7	40,5	1,73	13 000	20 000	0,61	7211 ACD/P4A	S	-	
100	21	52,7	40,5	1,73	15 000	24 000	0,51	7211 ACD/HCP4A	S	-	
100	21	55,3	43	1,8	14 000	22 000	0,61	7211 CD/P4A	S	-	
100	21	55,3	43	1,8	17 000	26 000	0,51	7211 CD/HCP4A	S	-	
60	78	10	12,7	13,4	0,57	15 000	22 000	0,1	71812 ACD/P4	-	-
	78	10	12,7	13,4	0,57	18 000	26 000	0,088	71812 ACD/HCP4	-	-
	78	10	13,5	14,3	0,6	16 000	24 000	0,1	71812 CD/P4	-	-
	78	10	13,5	14,3	0,6	19 000	30 000	0,088	71812 CD/HCP4	-	-
	85	13	9,75	8,3	0,355	19 000	30 000	0,2	71912 ACB/P4A	S	L
	85	13	9,75	8,3	0,355	22 000	36 000	0,18	71912 ACB/HCP4A	S	L
	85	13	10,4	8,8	0,375	22 000	32 000	0,2	71912 CB/P4A	S	L
	85	13	10,4	8,8	0,375	26 000	40 000	0,18	71912 CB/HCP4A	S	L

1) Designation prefix S. For details, refer to *Sealing solutions* (→ page 136).

2) Applicable to open bearings only.

3) Designation suffix H, H1, L or L1. For details, refer to *Direct oil-air lubrication* (→ page 136).

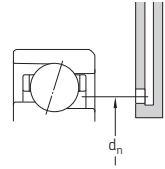
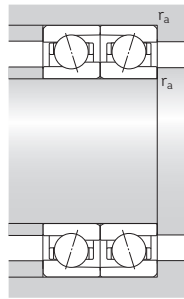
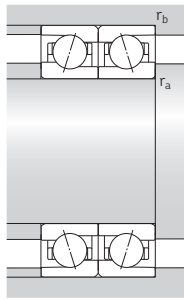
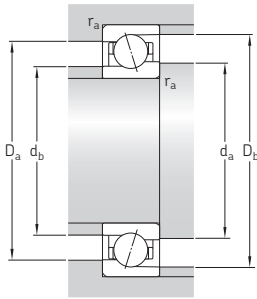

Dimensions					Abutment and fillet dimensions								Reference grease quantity ¹⁾	Calculation factor	
d	d ₁	d ₂	D ₁	D ₂	r _{1,2} min.	r _{3,4} min.	d _a min.	d _b min.	D _a max.	D _b max.	r _a max.	r _b max.	d _n	G _{ref}	f ₀
mm														cm ³	–
55 cont.	62,7	62,7	72,3	74,6	1	0,3	59,6	59,6	75,4	78	1	0,3	64,7	2,5	–
	62,7	62,7	72,3	74,6	1	0,3	59,6	59,6	75,4	78	1	0,3	64,7	2,5	–
	62,7	62,7	72,3	74,6	1	0,3	59,6	59,6	75,4	78	1	0,3	64,7	2,5	10,4
	62,7	62,7	72,3	74,6	1	0,3	59,6	59,6	75,4	78	1	0,3	64,7	2,5	10,4
	68,2	66,7	79,4	79,4	1,1	0,6	61	61	84	86,8	1	0,6	69,2	4,7	–
	68,2	66,7	79,4	79,4	1,1	0,6	61	61	84	86,8	1	0,6	69,2	4,7	–
	68,2	66,7	79,4	79,4	1,1	0,6	61	61	84	86,8	1	0,6	69,2	4,7	9,7
	68,2	66,7	79,4	79,4	1,1	0,6	61	61	84	86,8	1	0,6	69,2	4,7	9,7
	67,7	65,6	80,4	80,4	1,1	0,6	61	61	84	85,8	1	0,6	69,6	5	–
	67,7	65,6	80,4	80,4	1,1	0,6	61	61	84	85,8	1	0,6	69,6	5	–
	67,7	65,6	80,4	80,4	1,1	0,6	61	61	84	85,8	1	0,6	69,6	5	8,4
	67,7	65,6	80,4	80,4	1,1	0,6	61	61	84	85,8	1	0,6	69,6	5	8,4
65,8	65,8	79,2	81,8	1,1	0,6	61	61	84	86,8	1	0,6	68,1	5,1	–	
65,8	65,8	79,2	81,8	1,1	0,6	61	61	84	86,8	1	0,6	68,1	5,1	–	
65,8	65,8	79,2	81,8	1,1	0,6	61	61	84	86,8	1	0,6	68,1	5,1	15,1	
65,8	65,8	79,2	81,8	1,1	0,6	61	61	84	86,8	1	0,6	68,1	5,1	15,1	
68,9	68,9	86,1	89,1	1,5	0,6	64	64	91	95,8	1,5	0,6	72,6	8,6	–	
68,9	68,9	86,1	89,1	1,5	0,6	64	64	91	95,8	1,5	0,6	72,6	8,6	–	
68,9	68,9	86,1	89,1	1,5	0,6	64	64	91	95,8	1,5	0,6	72,6	8,6	14,5	
68,9	68,9	86,1	89,1	1,5	0,6	64	64	91	95,8	1,5	0,6	72,6	8,6	14,5	
60	65,7	65,7	72,5	–	0,3	0,15	62	62	76	77,2	0,3	0,15	66,4	1,2	–
	65,7	65,7	72,5	–	0,3	0,15	62	62	76	77,2	0,3	0,15	66,4	1,2	–
	65,7	65,7	72,5	–	0,3	0,15	62	62	76	77,2	0,3	0,15	66,4	1,2	17
	65,7	65,7	72,5	–	0,3	0,15	62	62	76	77,2	0,3	0,15	66,4	1,2	17
	68,9	67,7	78,4	78,4	1	0,3	64,6	64,6	80,4	83	1	0,3	69,8	2,8	–
	68,9	67,7	78,4	78,4	1	0,3	64,6	64,6	80,4	83	1	0,3	69,8	2,8	–
	68,9	67,7	78,4	78,4	1	0,3	64,6	64,6	80,4	83	1	0,3	69,8	2,8	9,8
	68,9	67,7	78,4	78,4	1	0,3	64,6	64,6	80,4	83	1	0,3	69,8	2,8	9,8

¹⁾ For calculating the initial grease fill → page 101

2.1 Angular contact ball bearings d 60 – 65 mm

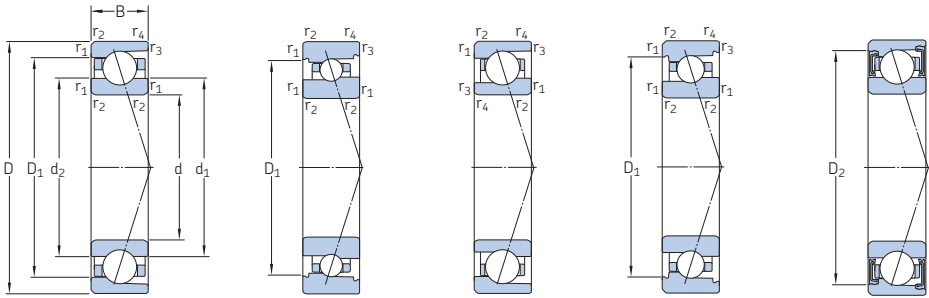

ACD, CD

ACB, CB

719 .. ACE,
719 .. CE70 .. ACE,
70 .. CE

S... 1)

Principal dimensions	Basic load ratings		Fatigue load limit P_u	Attainable speeds		Mass ²⁾	Designation	Available variants			
	dynamic C	static C_0		Grease lubrication	Oil-air lubrication ²⁾			Sealing solution ¹⁾	Direct oil-air lubrication ³⁾		
d D B	kN		kN	r/min		kg	-	-			
mm	kN		kN	r/min		kg	-	-			
60 cont.	85	13	15,3	11,2	0,475	19 500	30 000	0,19	71912 ACE/P4A	S	H1, L
	85	13	15,3	11,2	0,475	23 000	36 000	0,16	71912 ACE/HCP4A	S	H1, L
	85	13	16,3	11,8	0,5	22 000	34 000	0,19	71912 CE/P4A	S	H1, L
	85	13	16,3	11,8	0,5	26 000	40 000	0,16	71912 CE/HCP4A	S	H1, L
	85	13	18,6	14,6	0,62	14 000	22 000	0,19	71912 ACD/P4A	S	L
	85	13	18,6	14,6	0,62	16 000	26 000	0,16	71912 ACD/HCP4A	S	L
	85	13	19,9	15,3	0,655	15 000	24 000	0,19	71912 CD/P4A	S	L
	85	13	19,9	15,3	0,655	18 000	28 000	0,16	71912 CD/HCP4A	S	L
	95	18	13,5	11,4	0,48	17 000	26 000	0,45	7012 ACB/P4A	S	L
	95	18	13,5	11,4	0,48	22 000	32 000	0,43	7012 ACB/HCP4A	S	L
	95	18	14,6	12	0,51	19 000	30 000	0,45	7012 CB/P4A	S	L
	95	18	14,6	12	0,51	24 000	36 000	0,43	7012 CB/HCP4A	S	L
	95	18	16,3	12,2	0,52	18 000	28 000	0,42	7012 ACE/P4A	S	H1, L, L1
	95	18	16,3	12,2	0,52	22 000	33 000	0,39	7012 ACE/HCP4A	S	H1, L, L1
	95	18	17,2	12,9	0,54	20 000	31 000	0,42	7012 CE/P4A	S	H1, L, L1
	95	18	17,2	12,9	0,54	24 000	37 000	0,39	7012 CE/HCP4A	S	H1, L, L1
	95	18	39	33,5	1,4	13 000	20 000	0,4	7012 ACD/P4A	S	H1, L
	95	18	39	33,5	1,4	15 000	24 000	0,34	7012 ACD/HCP4A	S	H1, L
	95	18	40,3	34,5	1,5	14 000	22 000	0,4	7012 CD/P4A	S	H1, L
	95	18	40,3	34,5	1,5	17 000	26 000	0,34	7012 CD/HCP4A	S	H1, L
110	22	55,3	45	1,9	11 000	18 000	0,81	7212 ACD/P4A	S	-	
110	22	55,3	45	1,9	14 000	22 000	0,69	7212 ACD/HCP4A	S	-	
110	22	57,2	46,5	2	13 000	20 000	0,81	7212 CD/P4A	S	-	
110	22	57,2	46,5	2	16 000	24 000	0,69	7212 CD/HCP4A	S	-	
65	85	10	12,7	14	0,585	13 000	20 000	0,13	71813 ACD/P4	-	-
	85	10	12,7	14	0,585	16 000	24 000	0,11	71813 ACD/HCP4	-	-
	85	10	13,5	14,6	0,63	15 000	22 000	0,13	71813 CD/P4	-	-
	85	10	13,5	14,6	0,63	18 000	28 000	0,11	71813 CD/HCP4	-	-

1) Designation prefix S. For details, refer to *Sealing solutions* (→ page 136).

2) Applicable to open bearings only.

3) Designation suffix H, H1, L or L1. For details, refer to *Direct oil-air lubrication* (→ page 136).

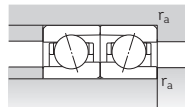
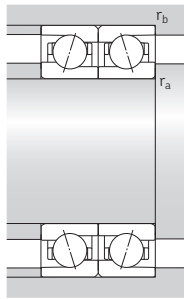
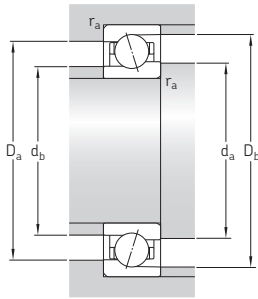

ACD, CD, ACB, CB,
70 .. ACE, 70 .. CE

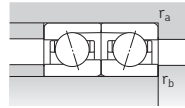
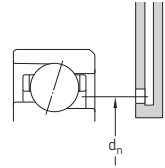

719 .. ACE, 719 .. CE

Dimensions					Abutment and fillet dimensions								Reference grease quantity ¹⁾	Calculation factor		
d	d ₁	d ₂	D ₁	D ₂	r _{1,2} min.	r _{3,4} min.	d _a min.	d _b min.	D _a max.	D _b max.	r _a max.	r _b max.	d _n	G _{ref}	f ₀	
mm															cm ³	–
60 cont.	67,8	65,7	77,3	79,7	1	0,3	64,6	62	80,4	83	1	0,3	69,6	2,5	–	
	67,8	65,7	77,3	79,7	1	0,3	64,6	62	80,4	83	1	0,3	69,6	2,5	–	
	67,8	65,7	77,3	79,7	1	0,3	64,6	62	80,4	83	1	0,3	69,6	2,5	8,5	
	67,8	65,7	77,3	79,7	1	0,3	64,6	62	80,4	83	1	0,3	69,6	2,5	8,5	
	67,7	67,7	77,3	79,6	1	0,3	64,6	64,6	80,4	83	1	0,3	69,7	2,7	–	
	67,7	67,7	77,3	79,6	1	0,3	64,6	64,6	80,4	83	1	0,3	69,7	2,7	–	
	67,7	67,7	77,3	79,6	1	0,3	64,6	64,6	80,4	83	1	0,3	69,7	2,7	10,5	
	67,7	67,7	77,3	79,6	1	0,3	64,6	64,6	80,4	83	1	0,3	69,7	2,7	10,5	
	73,2	71,7	84,4	84,4	1,1	0,6	66	66	89	91,8	1	0,6	74,2	5	–	
	73,2	71,7	84,4	84,4	1,1	0,6	66	66	89	91,8	1	0,6	74,2	5	–	
	73,2	71,7	84,4	84,4	1,1	0,6	66	66	89	91,8	1	0,6	74,2	5	9,7	
	73,2	71,7	84,4	84,4	1,1	0,6	66	66	89	91,8	1	0,6	74,2	5	9,7	
72,7	70,6	85,4	85,4	1,1	0,6	66	66	89	90,8	1	0,6	74,6	5,3	–		
72,7	70,6	85,4	85,4	1,1	0,6	66	66	89	90,8	1	0,6	74,6	5,3	–		
72,7	70,6	85,4	85,4	1,1	0,6	66	66	89	90,8	1	0,6	74,6	5,3	8,5		
72,7	70,6	85,4	85,4	1,1	0,6	66	66	89	90,8	1	0,6	74,6	5,3	8,5		
70,8	70,8	84,2	86,7	1,1	0,6	66	66	89	91,8	1	0,6	73,1	5,4	–		
70,8	70,8	84,2	86,7	1,1	0,6	66	66	89	91,8	1	0,6	73,1	5,4	–		
70,8	70,8	84,2	86,7	1,1	0,6	66	66	89	91,8	1	0,6	73,1	5,4	15,4		
70,8	70,8	84,2	86,7	1,1	0,6	66	66	89	91,8	1	0,6	73,1	5,4	15,4		
76,4	76,4	93,6	96,8	1,5	0,6	69	69	101	105,8	1,5	0,6	80,1	10	–		
76,4	76,4	93,6	96,8	1,5	0,6	69	69	101	105,8	1,5	0,6	80,1	10	–		
76,4	76,4	93,6	96,8	1,5	0,6	69	69	101	105,8	1,5	0,6	80,1	10	14,9		
76,4	76,4	93,6	96,8	1,5	0,6	69	69	101	105,8	1,5	0,6	80,1	10	14,9		
65	71,7	71,7	78,5	–	0,6	0,3	68,2	68,2	81,8	83	0,6	0,3	72,4	1,3	–	
	71,7	71,7	78,5	–	0,6	0,3	68,2	68,2	81,8	83	0,6	0,3	72,4	1,3	–	
	71,7	71,7	78,5	–	0,6	0,3	68,2	68,2	81,8	83	0,6	0,3	72,4	1,3	17,1	
	71,7	71,7	78,5	–	0,6	0,3	68,2	68,2	81,8	83	0,6	0,3	72,4	1,3	17,1	

¹⁾ For calculating the initial grease fill → page 101

2.1 Angular contact ball bearings d 65 mm

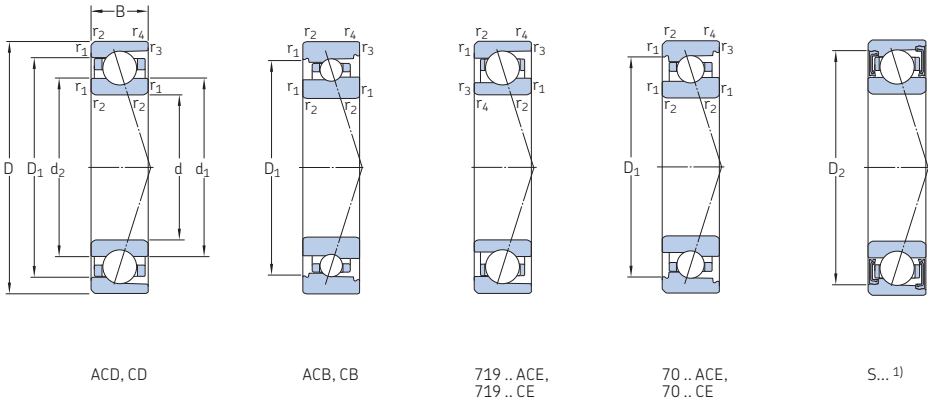

Principal dimensions	Basic load ratings		Fatigue load limit P_u	Attainable speeds		Mass ²⁾	Designation	Available variants			
	dynamic C	static C_0		Grease lubrication	Oil-air lubrication ²⁾			Sealing solution ¹⁾	Direct oil-air lubrication ³⁾		
d	D	B	kN	kN	r/min	kg	-	-	-		
mm	mm	mm	kN	kN	r/min	kg	-	-	-		
65 cont.	90	13	9,95	9	0,38	18 000	28 000	0,21	71913 ACB/P4A	S	L
	90	13	9,95	9	0,38	22 000	34 000	0,19	71913 ACB/HCP4A	S	L
	90	13	10,6	9,5	0,4	20 000	30 000	0,21	71913 CB/P4A	S	L
	90	13	10,6	9,5	0,4	24 000	36 000	0,19	71913 CB/HCP4A	S	L
	90	13	15,6	11,8	0,5	18 000	28 000	0,2	71913 ACE/P4A	S	H1, L
	90	13	15,6	11,8	0,5	22 000	34 000	0,17	71913 ACE/HCP4A	S	H1, L
	90	13	16,5	12,5	0,53	20 000	31 000	0,2	71913 CE/P4A	S	H1, L
	90	13	16,5	12,5	0,53	24 000	38 000	0,17	71913 CE/HCP4A	S	H1, L
	90	13	19,5	16	0,68	13 000	20 000	0,21	71913 ACD/P4A	S	L
	90	13	19,5	16	0,68	15 000	24 000	0,17	71913 ACD/HCP4A	S	L
	90	13	20,8	17	0,71	14 000	22 000	0,21	71913 CD/P4A	S	L
	90	13	20,8	17	0,71	17 000	26 000	0,17	71913 CD/HCP4A	S	L
	100	18	14,6	12,2	0,52	16 000	26 000	0,47	7013 ACB/P4A	S	L
	100	18	14,6	12,2	0,52	19 000	30 000	0,45	7013 ACB/HCP4A	S	L
	100	18	15,6	12,9	0,55	18 000	28 000	0,47	7013 CB/P4A	S	L
	100	18	15,6	12,9	0,55	22 000	34 000	0,45	7013 CB/HCP4A	S	L
	100	18	19,5	14,6	0,62	17 000	26 000	0,43	7013 ACE/P4A	S	H1, L, L1
	100	18	19,5	14,6	0,62	20 000	31 000	0,39	7013 ACE/HCP4A	S	H1, L, L1
	100	18	20,3	15,6	0,655	19 000	30 000	0,43	7013 CE/P4A	S	H1, L, L1
	100	18	20,3	15,6	0,655	22 000	34 000	0,39	7013 CE/HCP4A	S	H1, L, L1
	100	18	39	35,5	1,5	12 000	19 000	0,43	7013 ACD/P4A	S	H1, L
	100	18	39	35,5	1,5	15 000	22 000	0,36	7013 ACD/HCP4A	S	H1, L
	100	18	41,6	37,5	1,6	14 000	22 000	0,43	7013 CD/P4A	S	H1, L
	100	18	41,6	37,5	1,6	16 000	24 000	0,36	7013 CD/HCP4A	S	H1, L
120	23	63,7	51	2,2	10 000	17 000	1,05	7213 ACD/P4A	S	-	
120	23	63,7	51	2,2	13 000	20 000	0,88	7213 ACD/HCP4A	S	-	
120	23	66,3	53	2,28	12 000	19 000	1,05	7213 CD/P4A	S	-	
120	23	66,3	53	2,28	15 000	22 000	0,88	7213 CD/HCP4A	S	-	

1) Designation prefix S. For details, refer to *Sealing solutions* (→ page 136).

2) Applicable to open bearings only.

3) Designation suffix H, H1, L or L1. For details, refer to *Direct oil-air lubrication* (→ page 136).

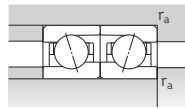
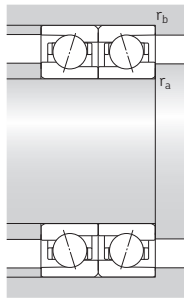
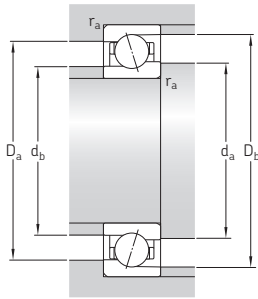

ACD, CD, ACB, CB,
70 .. ACE, 70 .. CE

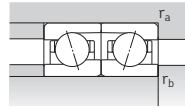
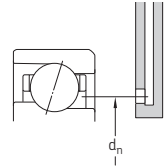

719 .. ACE, 719 .. CE

Dimensions					Abutment and fillet dimensions								Reference grease quantity ¹⁾	Calculation factor	
d	d ₁	d ₂	D ₁	D ₂	r _{1,2} min.	r _{3,4} min.	d _a min.	d _b min.	D _a max.	D _b max.	r _a max.	r _b max.	d _n	G _{ref}	f ₀
mm														cm ³	–
65 cont.	73,9	72,7	83,5	83,5	1	0,3	69,6	69,6	85,4	88	1	0,3	74,8	3	–
	73,9	72,7	83,5	83,5	1	0,3	69,6	69,6	85,4	88	1	0,3	74,8	3	–
	73,9	72,7	83,5	83,5	1	0,3	69,6	69,6	85,4	88	1	0,3	74,8	3	9,9
	73,9	72,7	83,5	83,5	1	0,3	69,6	69,6	85,4	88	1	0,3	74,8	3	9,9
	72,8	70,7	82,3	84,7	1	0,3	69,6	67	85,4	88	1	0,3	74,5	2,6	–
	72,8	70,7	82,3	84,7	1	0,3	69,6	67	85,4	88	1	0,3	74,5	2,6	–
	72,8	70,7	82,3	84,7	1	0,3	69,6	67	85,4	88	1	0,3	74,5	2,6	8,5
	72,8	70,7	82,3	84,7	1	0,3	69,6	67	85,4	88	1	0,3	74,5	2,6	8,5
	72,7	72,7	82,3	84,5	1	0,3	69,6	69,6	85,4	88	1	0,3	74,7	2,9	–
	72,7	72,7	82,3	84,5	1	0,3	69,6	69,6	85,4	88	1	0,3	74,7	2,9	–
	72,7	72,7	82,3	84,5	1	0,3	69,6	69,6	85,4	88	1	0,3	74,7	2,9	10,7
	72,7	72,7	82,3	84,5	1	0,3	69,6	69,6	85,4	88	1	0,3	74,7	2,9	10,7
78	76,4	89,7	89,7	1,1	0,6	71	71	94	96,8	1	0,6	79	5,5	–	
78	76,4	89,7	89,7	1,1	0,6	71	71	94	96,8	1	0,6	79	5,5	–	
78	76,4	89,7	89,7	1,1	0,6	71	71	94	96,8	1	0,6	79	5,5	9,7	
78	76,4	89,7	89,7	1,1	0,6	71	71	94	96,8	1	0,6	79	5,5	9,7	
77,3	74,9	91,1	91,1	1,1	0,6	71	71	94	95,8	1	0,6	79,3	6,2	–	
77,3	74,9	91,1	91,1	1,1	0,6	71	71	94	95,8	1	0,6	79,3	6,2	–	
77,3	74,9	91,1	91,1	1,1	0,6	71	71	94	95,8	1	0,6	79,3	6,2	8,4	
77,3	74,9	91,1	91,1	1,1	0,6	71	71	94	95,8	1	0,6	79,3	6,2	8,4	
75,8	75,8	89,2	91,7	1,1	0,6	71	71	94	96,8	1	0,6	78,1	5,7	–	
75,8	75,8	89,2	91,7	1,1	0,6	71	71	94	96,8	1	0,6	78,1	5,7	–	
75,8	75,8	89,2	91,7	1,1	0,6	71	71	94	96,8	1	0,6	78,1	5,7	15,6	
75,8	75,8	89,2	91,7	1,1	0,6	71	71	94	96,8	1	0,6	78,1	5,7	15,6	
82,9	82,9	102,1	105,3	1,5	0,6	74	74	111	115,8	1,5	0,6	86,6	12	–	
82,9	82,9	102,1	105,3	1,5	0,6	74	74	111	115,8	1,5	0,6	86,6	12	–	
82,9	82,9	102,1	105,3	1,5	0,6	74	74	111	115,8	1,5	0,6	86,6	12	14,6	
82,9	82,9	102,1	105,3	1,5	0,6	74	74	111	115,8	1,5	0,6	86,6	12	14,6	

¹⁾ For calculating the initial grease fill → page 101

2.1 Angular contact ball bearings

d 70 mm

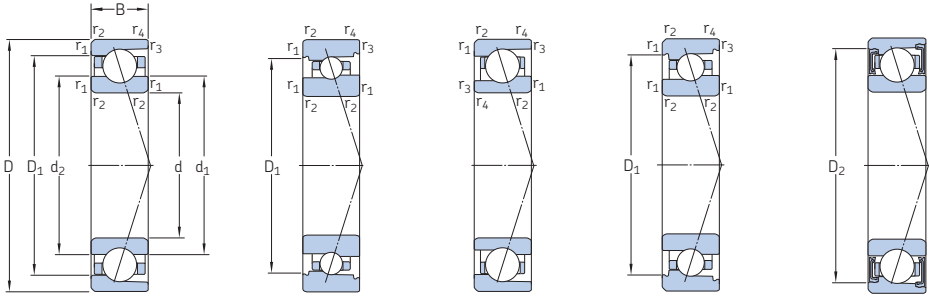

ACD, CD

ACB, CB

719 .. ACE,
719 .. CE70 .. ACE,
70 .. CE

S... 1)

Principal dimensions			Basic load ratings		Fatigue load limit P_u	Attainable speeds		Mass ²⁾	Designation	Available variants	
d	D	B	dynamic C	static C_0		Grease lubrication	Oil-air lubrication ²⁾			Sealing solution ¹⁾	Direct oil-air lubrication ³⁾
mm			kN		kN	r/min		kg	-	-	
70	90	10	13	15	0,64	13 000	19 000	0,13	71814 ACD/P4	-	-
	90	10	13	15	0,64	15 000	24 000	0,12	71814 ACD/HCP4	-	-
	90	10	13,8	16	0,67	14 000	22 000	0,13	71814 CD/P4	-	-
	90	10	13,8	16	0,67	17 000	26 000	0,12	71814 CD/HCP4	-	-
	100	16	12,7	11,6	0,49	16 000	24 000	0,35	71914 ACB/P4A	S	L
	100	16	12,7	11,6	0,49	19 000	30 000	0,33	71914 ACB/HCP4A	S	L
	100	16	13,5	12,2	0,52	18 000	28 000	0,35	71914 CB/P4A	S	L
	100	16	13,5	12,2	0,52	22 000	32 000	0,33	71914 CB/HCP4A	S	L
	100	16	20,8	15,3	0,655	16 500	26 000	0,32	71914 ACE/P4A	S	H1, L
	100	16	20,8	15,3	0,655	20 000	31 000	0,27	71914 ACE/HCP4A	S	H1, L
	100	16	22,1	16,3	0,68	18 500	28 000	0,32	71914 CE/P4A	S	H1, L
	100	16	22,1	16,3	0,68	22 000	34 000	0,27	71914 CE/HCP4A	S	H1, L
100	16	32,5	32,5	1,37	11 000	18 000	0,33	71914 ACD/P4A	S	H1, L	
100	16	32,5	32,5	1,37	14 000	22 000	0,28	71914 ACD/HCP4A	S	H1, L	
100	16	34,5	34	1,43	13 000	20 000	0,33	71914 CD/P4A	S	H1, L	
100	16	34,5	34	1,43	16 000	24 000	0,28	71914 CD/HCP4A	S	H1, L	
110	20	18,2	15,6	0,655	15 000	24 000	0,66	7014 ACB/P4A	S	L	
110	20	18,2	15,6	0,655	18 000	28 000	0,63	7014 ACB/HCP4A	S	L	
110	20	19	16,3	0,695	17 000	26 000	0,66	7014 CB/P4A	S	L	
110	20	19	16,3	0,695	19 000	30 000	0,63	7014 CB/HCP4A	S	L	
110	20	22,5	17,3	0,735	15 500	24 000	0,61	7014 ACE/P4A	S	H1, L, L1	
110	20	22,5	17,3	0,735	18 500	29 000	0,56	7014 ACE/HCP4A	S	H1, L, L1	
110	20	23,8	18,3	0,78	17 000	27 000	0,61	7014 CE/P4A	S	H1, L, L1	
110	20	23,8	18,3	0,78	20 500	32 000	0,56	7014 CE/HCP4A	S	H1, L, L1	
110	20	48,8	44	1,86	11 000	17 000	0,6	7014 ACD/P4A	S	H1, L	
110	20	48,8	44	1,86	13 000	20 000	0,5	7014 ACD/HCP4A	S	H1, L	
110	20	52	45,5	1,93	12 000	19 000	0,6	7014 CD/P4A	S	H1, L	
110	20	52	45,5	1,93	15 000	22 000	0,5	7014 CD/HCP4A	S	H1, L	

1) Designation prefix S. For details, refer to *Sealing solutions* (→ page 136).

2) Applicable to open bearings only.

3) Designation suffix H, H1, L or L1. For details, refer to *Direct oil-air lubrication* (→ page 136).

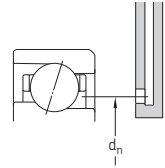
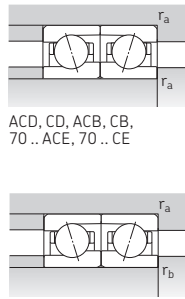
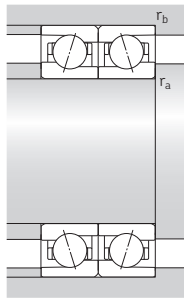
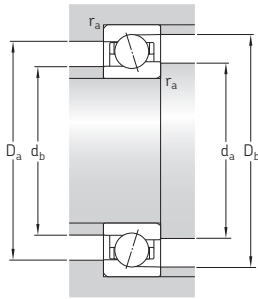

ACD, CD, ACB, CB,
70 .. ACE, 70 .. CE

719 .. ACE, 719 .. CE

Dimensions					Abutment and fillet dimensions									Reference grease quantity ¹⁾	Calculation factor	
d	d ₁	d ₂	D ₁	D ₂	r _{1,2} min.	r _{3,4} min.	d _a min.	d _b min.	D _a max.	D _b max.	r _a max.	r _b max.	d _n	G _{ref}	f ₀	
mm															cm ³	-
70	76,7	76,7	83,5	-	0,6	0,3	73,2	73,2	86,8	88	0,6	0,3	77,4	1,4	-	
	76,7	76,7	83,5	-	0,6	0,3	73,2	73,2	86,8	88	0,6	0,3	77,4	1,4	-	
	76,7	76,7	83,5	-	0,6	0,3	73,2	73,2	86,8	88	0,6	0,3	77,4	1,4	17,2	
	76,7	76,7	83,5	-	0,6	0,3	73,2	73,2	86,8	88	0,6	0,3	77,4	1,4	17,2	
80,9	79,6	91,7	91,7	1	0,3	74,6	74,6	95,4	98	1	0,3	81,9	4,5	-		
	79,6	91,7	91,7	1	0,3	74,6	74,6	95,4	98	1	0,3	81,9	4,5	-		
	79,6	91,7	91,7	1	0,3	74,6	74,6	95,4	98	1	0,3	81,9	4,5	9,9		
	79,6	91,7	91,7	1	0,3	74,6	74,6	95,4	98	1	0,3	81,9	4,5	9,9		
79,3	76,8	90,5	93,6	1	0,3	74,6	72	95,4	98	1	0,3	81,5	4,3	-		
	76,8	90,5	93,6	1	0,3	74,6	72	95,4	98	1	0,3	81,5	4,3	-		
	76,8	90,5	93,6	1	0,3	74,6	72	95,4	98	1	0,3	81,5	4,3	8,4		
	76,8	90,5	93,6	1	0,3	74,6	72	95,4	98	1	0,3	81,5	4,3	8,4		
79,2	79,2	90,8	93,7	1	0,3	74,6	74,6	95,4	98	1	0,3	81,7	4,5	-		
	79,2	90,8	93,7	1	0,3	74,6	74,6	95,4	98	1	0,3	81,7	4,5	-		
	79,2	90,8	93,7	1	0,3	74,6	74,6	95,4	98	1	0,3	81,7	4,5	16,2		
	79,2	90,8	93,7	1	0,3	74,6	74,6	95,4	98	1	0,3	81,7	4,5	16,2		
85	83,2	97,8	97,8	1,1	0,6	76	76	104	106,8	1	0,6	86,1	7,3	-		
	83,2	97,8	97,8	1,1	0,6	76	76	104	106,8	1	0,6	86,1	7,3	-		
	83,2	97,8	97,8	1,1	0,6	76	76	104	106,8	1	0,6	86,1	7,3	9,6		
	83,2	97,8	97,8	1,1	0,6	76	76	104	106,8	1	0,6	86,1	7,3	9,6		
84,3	81,6	98,6	98,6	1,1	0,6	76	76	104	105,8	1	0,6	86,5	8,2	-		
	81,6	98,6	98,6	1,1	0,6	76	76	104	105,8	1	0,6	86,5	8,2	-		
	81,6	98,6	98,6	1,1	0,6	76	76	104	105,8	1	0,6	86,5	8,2	8,4		
	81,6	98,6	98,6	1,1	0,6	76	76	104	105,8	1	0,6	86,5	8,2	8,4		
82,3	82,3	97,7	100,6	1,1	0,6	76	76	104	106	1	0,6	85	8,1	-		
	82,3	97,7	100,6	1,1	0,6	76	76	104	106	1	0,6	85	8,1	-		
	82,3	97,7	100,6	1,1	0,6	76	76	104	106	1	0,6	85	8,1	15,5		
	82,3	97,7	100,6	1,1	0,6	76	76	104	106	1	0,6	85	8,1	15,5		

¹⁾ For calculating the initial grease fill → page 101

2.1 Angular contact ball bearings d 70 – 75 mm

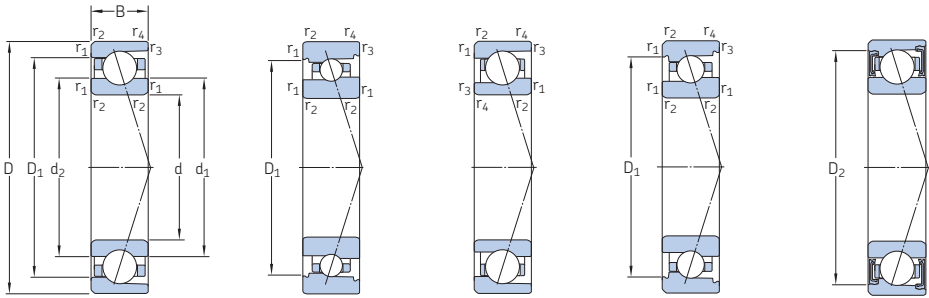

ACD, CD

ACB, CB

719 .. ACE,
719 .. CE70 .. ACE,
70 .. CE

S... 1)

Principal dimensions			Basic load ratings		Fatigue load limit P_u	Attainable speeds		Mass ²⁾	Designation	Available variants	
d	D	B	dynamic C	static C_0		Grease lubrication	Oil-air lubrication ²⁾			Sealing solution ¹⁾	Direct oil-air lubrication ³⁾
mm			kN		kN	r/min		kg	-	-	
70 cont.	125	24	66,3	55	2,36	9 500	16 000	1,1	7214 ACD/P4A	S	-
	125	24	66,3	55	2,36	12 000	19 000	0,95	7214 ACD/HCP4A	S	-
	125	24	68,9	58,5	2,45	11 000	18 000	1,1	7214 CD/P4A	S	-
	125	24	68,9	58,5	2,45	14 000	20 000	0,95	7214 CD/HCP4A	S	-
75	95	10	13,3	16	0,68	12 000	18 000	0,14	71815 ACD/P4	-	-
	95	10	13,3	16	0,68	14 000	22 000	0,13	71815 ACD/HCP4	-	-
	95	10	14,3	17	0,72	13 000	20 000	0,14	71815 CD/P4	-	-
	95	10	14,3	17	0,72	16 000	24 000	0,13	71815 CD/HCP4	-	-
105	16	13,3	12,5	0,52	15 000	24 000	0,37	71915 ACB/P4A	S	L	
105	16	13,3	12,5	0,52	18 000	28 000	0,34	71915 ACB/HCP4A	S	L	
105	16	14	13,2	0,56	17 000	26 000	0,37	71915 CB/P4A	S	L	
105	16	14	13,2	0,56	20 000	30 000	0,34	71915 CB/HCP4A	S	L	
105	16	21,2	16,3	0,68	15 500	24 000	0,34	71915 ACE/P4A	S	H1, L	
105	16	21,2	16,3	0,68	18 500	29 000	0,29	71915 ACE/HCP4A	S	H1, L	
105	16	22,5	17	0,72	17 500	27 000	0,34	71915 CE/P4A	S	H1, L	
105	16	22,5	17	0,72	20 500	32 000	0,29	71915 CE/HCP4A	S	H1, L	
105	16	33,8	35,5	1,5	10 000	17 000	0,35	71915 ACD/P4A	S	H1, L	
105	16	33,8	35,5	1,5	13 000	20 000	0,3	71915 ACD/HCP4A	S	H1, L	
105	16	35,8	37,5	1,56	12 000	19 000	0,35	71915 CD/P4A	S	H1, L	
105	16	35,8	37,5	1,56	15 000	22 000	0,3	71915 CD/HCP4A	S	H1, L	
115	20	19	16,6	0,71	14 000	22 000	0,7	7015 ACB/P4A	S	L	
115	20	19	16,6	0,71	17 000	26 000	0,66	7015 ACB/HCP4A	S	L	
115	20	19,9	17,6	0,75	16 000	24 000	0,7	7015 CB/P4A	S	L	
115	20	19,9	17,6	0,75	18 000	28 000	0,66	7015 CB/HCP4A	S	L	
115	20	24,7	20,4	0,865	14 500	23 000	0,65	7015 ACE/P4A	S	H1, L, L1	
115	20	24,7	20,4	0,865	17 000	27 000	0,59	7015 ACE/HCP4A	S	H1, L, L1	
115	20	26	21,6	0,915	16 000	26 000	0,65	7015 CE/P4A	S	H1, L, L1	
115	20	26	21,6	0,915	19 000	29 000	0,59	7015 CE/HCP4A	S	H1, L, L1	

1) Designation prefix S. For details, refer to *Sealing solutions* (→ page 136).

2) Applicable to open bearings only.

3) Designation suffix H, H1, L or L1. For details, refer to *Direct oil-air lubrication* (→ page 136).

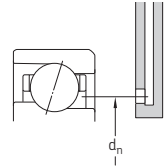
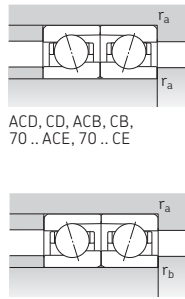
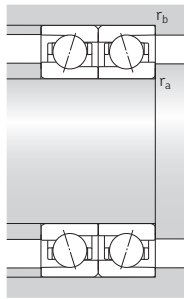
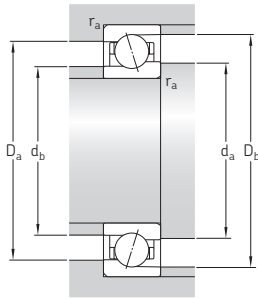

ACD, CD, ACB, CB,
70 .. ACE, 70 .. CE

719 .. ACE, 719 .. CE

Dimensions					Abutment and fillet dimensions								Reference grease quantity ¹⁾	Calculation factor		
d	d ₁	d ₂	D ₁	D ₂	r _{1,2} min.	r _{3,4} min.	d _a min.	d _b min.	D _a max.	D _b max.	r _a max.	r _b max.	d _n	G _{ref}	f ₀	
mm															cm ³	-
70 cont.	87,9	87,9	107,1	110,3	1,5	0,6	79	79	116	120,8	1,5	0,6	91,6	14	-	
	87,9	87,9	107,1	110,3	1,5	0,6	79	79	116	120,8	1,5	0,6	91,6	14	-	
	87,9	87,9	107,1	110,3	1,5	0,6	79	79	116	120,8	1,5	0,6	91,6	14	14,8	
	87,9	87,9	107,1	110,3	1,5	0,6	79	79	116	120,8	1,5	0,6	91,6	14	14,8	
75	81,7	81,7	88,5	-	0,6	0,3	78,2	78,2	91,8	93	0,6	0,3	82,4	1,5	-	
	81,7	81,7	88,5	-	0,6	0,3	78,2	78,2	91,8	93	0,6	0,3	82,4	1,5	-	
	81,7	81,7	88,5	-	0,6	0,3	78,2	78,2	91,8	93	0,6	0,3	82,4	1,5	17,3	
	81,7	81,7	88,5	-	0,6	0,3	78,2	78,2	91,8	93	0,6	0,3	82,4	1,5	17,3	
	85,9	84,6	97,5	97,5	1	0,6	79,6	79,6	100	101,8	1	0,6	86,9	4,8	-	
	85,9	84,6	97,5	97,5	1	0,6	79,6	79,6	100	101,8	1	0,6	86,9	4,8	-	
	85,9	84,6	97,5	97,5	1	0,6	79,6	79,6	100	101,8	1	0,6	86,9	4,8	9,9	
	85,9	84,6	97,5	97,5	1	0,6	79,6	79,6	100	101,8	1	0,6	86,9	4,8	9,9	
	84,3	81,8	95,5	98,6	1	0,3	79,6	77	100,4	103	1	0,3	86,5	4,5	-	
	84,3	81,8	95,5	98,6	1	0,3	79,6	77	100,4	103	1	0,3	86,5	4,5	-	
	84,3	81,8	95,5	98,6	1	0,3	79,6	77	100,4	103	1	0,3	86,5	4,5	8,5	
	84,3	81,8	95,5	98,6	1	0,3	79,6	77	100,4	103	1	0,3	86,5	4,5	8,5	
	84,2	84,2	95,8	98,7	1	0,3	79,6	79,6	100	103	1	0,3	86,7	5,1	-	
	84,2	84,2	95,8	98,7	1	0,3	79,6	79,6	100	103	1	0,3	86,7	5,1	-	
	84,2	84,2	95,8	98,7	1	0,3	79,6	79,6	100	103	1	0,3	86,7	5,1	16,3	
	84,2	84,2	95,8	98,7	1	0,3	79,6	79,6	100	103	1	0,3	86,7	5,1	16,3	
90	88,2	102,8	102,8	1,1	0,6	81	81	109	111,8	1	0,6	91,1	7,7	-		
90	88,2	102,8	102,8	1,1	0,6	81	81	109	111,8	1	0,6	91,1	7,7	-		
90	88,2	102,8	102,8	1,1	0,6	81	81	109	111,8	1	0,6	91,1	7,7	9,7		
90	88,2	102,8	102,8	1,1	0,6	81	81	109	111,8	1	0,6	91,1	7,7	9,7		
89,3	86,8	104,1	104,1	1,1	0,6	81	81	109	110,8	1	0,6	91,5	8,6	-		
89,3	86,8	104,1	104,1	1,1	0,6	81	81	109	110,8	1	0,6	91,5	8,6	-		
89,3	86,8	104,1	104,1	1,1	0,6	81	81	109	110,8	1	0,6	91,5	8,6	9,5		
89,3	86,8	104,1	104,1	1,1	0,6	81	81	109	110,8	1	0,6	91,5	8,6	9,5		

¹⁾ For calculating the initial grease fill → page 101

2.1 Angular contact ball bearings d 75 – 80 mm

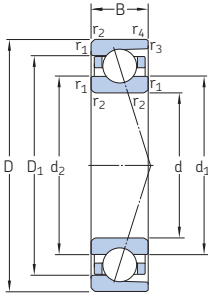

ACD, CD

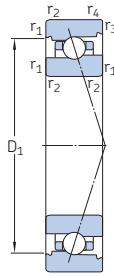

ACB, CB

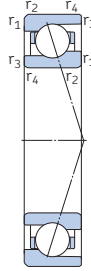

719 .. ACE,
719 .. CE

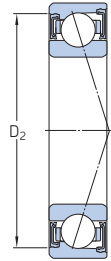

S... 1)

Principal dimensions	Basic load ratings		Fatigue load limit P_u	Attainable speeds		Mass ²⁾	Designation	Available variants				
	dynamic C	static C_0		Grease lubrication	Oil-air lubrication ²⁾			Sealing solution ¹⁾	Direct oil-air lubrication ³⁾			
d D B	kN		kN	r/min		kg	-	-				
mm	kN		kN	r/min		kg	-	-				
75 cont.	115	20	49,4	46,5	1,96	10 000	16 000	0,63	7015 ACD/P4A	S	H1, L	
	115	20	49,4	46,5	1,96	13 000	20 000	0,53	7015 ACD/HCP4A	S	H1, L	
	115	20	52,7	49	2,08	11 000	18 000	0,63	7015 CD/P4A	S	H1, L	
	115	20	52,7	49	2,08	14 000	22 000	0,53	7015 CD/HCP4A	S	H1, L	
	130	25	68,9	58,5	2,5	9 000	15 000	1,2	7215 ACD/P4A	S	-	
	130	25	68,9	58,5	2,5	11 000	18 000	1,05	7215 ACD/HCP4A	S	-	
	130	25	71,5	62	2,65	10 000	17 000	1,2	7215 CD/P4A	S	-	
	130	25	71,5	62	2,65	14 000	20 000	1,05	7215 CD/HCP4A	S	-	
	80	100	10	13,8	17	0,72	11 000	17 000	0,15	71816 ACD/P4	-	-
		100	10	13,8	17	0,72	13 000	20 000	0,14	71816 ACD/HCP4	-	-
		100	10	14,6	18,3	0,765	12 000	19 000	0,15	71816 CD/P4	-	-
		100	10	14,6	18,3	0,765	15 000	22 000	0,14	71816 CD/HCP4	-	-
110		16	14,8	14	0,585	14 000	22 000	0,38	71916 ACB/P4A	S	L	
110		16	14,8	14	0,585	17 000	26 000	0,35	71916 ACB/HCP4A	S	L	
110		16	15,6	14,6	0,63	16 000	24 000	0,38	71916 CB/P4A	S	L	
110		16	15,6	14,6	0,63	19 000	30 000	0,35	71916 CB/HCP4A	S	L	
110		16	21,2	17	0,71	14 500	22 000	0,36	71916 ACE/P4A	S	H1, L	
110		16	21,2	17	0,71	17 500	27 000	0,31	71916 ACE/HCP4A	S	H1, L	
110		16	22,5	18	0,75	16 500	25 000	0,36	71916 CE/P4A	S	H1, L	
110		16	22,5	18	0,75	19 000	30 000	0,31	71916 CE/HCP4A	S	H1, L	
110		16	34,5	36,5	1,56	9 500	16 000	0,37	71916 ACD/P4A	S	H1, L	
110		16	34,5	36,5	1,56	12 000	19 000	0,32	71916 ACD/HCP4A	S	H1, L	
110		16	36,4	39	1,66	11 000	18 000	0,37	71916 CD/P4A	S	H1, L	
110		16	36,4	39	1,66	15 000	22 000	0,32	71916 CD/HCP4A	S	H1, L	
125		22	25,1	21,6	0,9	12 000	19 000	0,92	7016 ACB/P4A	S	L	
125		22	25,1	21,6	0,9	15 000	22 000	0,86	7016 ACB/HCP4A	S	L	
125		22	26,5	22,8	0,95	14 000	20 000	0,92	7016 CB/P4A	S	L	
125		22	26,5	22,8	0,95	17 000	26 000	0,86	7016 CB/HCP4A	S	L	

1) Designation prefix S. For details, refer to *Sealing solutions* (→ page 136).

2) Applicable to open bearings only.

3) Designation suffix H, H1, L or L1. For details, refer to *Direct oil-air lubrication* (→ page 136).

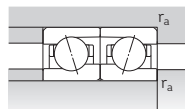
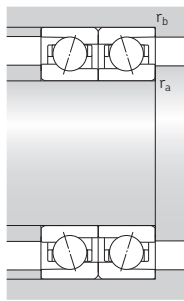
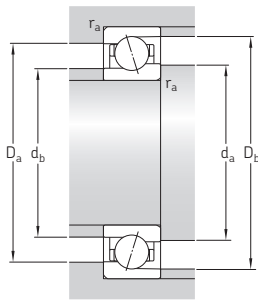

ACD, CD, ACB, CB

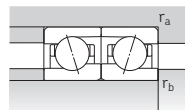

719 .. ACE, 719 .. CE

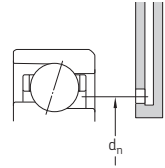

Dimensions					Abutment and fillet dimensions										Reference grease quantity ¹⁾	Calculation factor
d	d ₁	d ₂	D ₁	D ₂	r _{1,2} min.	r _{3,4} min.	d _a min.	d _b min.	D _a max.	D _b max.	r _a max.	r _b max.	d _n	G _{ref}	f ₀	
mm															cm ³	–
75 cont.	87,3	87,3	102,7	105,6	1,1	0,6	81	81	109	111	1	0,6	90	8,4	–	
	87,3	87,3	102,7	105,6	1,1	0,6	81	81	109	111	1	0,6	90	8,4	–	
	87,3	87,3	102,7	105,6	1,1	0,6	81	81	109	111	1	0,6	90	8,4	15,7	
	87,3	87,3	102,7	105,6	1,1	0,6	81	81	109	111	1	0,6	90	8,4	15,7	
80	92,9	92,9	112,1	115,3	1,5	0,6	84	84	121	125,8	1,5	0,6	96,6	15	–	
	92,9	92,9	112,1	115,3	1,5	0,6	84	84	121	125,8	1,5	0,6	96,6	15	–	
	92,9	92,9	112,1	115,3	1,5	0,6	84	84	121	125,8	1,5	0,6	96,6	15	15	
	92,9	92,9	112,1	115,3	1,5	0,6	84	84	121	125,8	1,5	0,6	96,6	15	15	
	86,7	86,7	93,5	–	0,6	0,3	83,2	83,2	96,8	98	0,6	0,3	87,4	1,6	–	
	86,7	86,7	93,5	–	0,6	0,3	83,2	83,2	96,8	98	0,6	0,3	87,4	1,6	–	
	86,7	86,7	93,5	–	0,6	0,3	83,2	83,2	96,8	98	0,6	0,3	87,4	1,6	17,4	
	86,7	86,7	93,5	–	0,6	0,3	83,2	83,2	96,8	98	0,6	0,3	87,4	1,6	17,4	
	90,7	89,2	102,2	102,2	1	0,6	84,6	84,6	105	106,8	1	0,6	91,7	5,3	–	
	90,7	89,2	102,2	102,2	1	0,6	84,6	84,6	105	106,8	1	0,6	91,7	5,3	–	
	90,7	89,2	102,2	102,2	1	0,6	84,6	84,6	105	106,8	1	0,6	91,7	5,3	9,9	
	90,7	89,2	102,2	102,2	1	0,6	84,6	84,6	105	106,8	1	0,6	91,7	5,3	9,9	
89,3	86,8	100,5	103,6	1	0,3	84,6	82	105,4	108	1	0,3	91,5	4,8	–		
89,3	86,8	100,5	103,6	1	0,3	84,6	82	105,4	108	1	0,3	91,5	4,8	–		
89,3	86,8	100,5	103,6	1	0,3	84,6	82	105,4	108	1	0,3	91,5	4,8	8,6		
89,3	86,8	100,5	103,6	1	0,3	84,6	82	105,4	108	1	0,3	91,5	4,8	8,6		
89,2	89,2	100,8	103,7	1	0,3	84,6	84,6	105	108	1	0,3	91,7	5,1	–		
89,2	89,2	100,8	103,7	1	0,3	84,6	84,6	105	108	1	0,3	91,7	5,1	–		
89,2	89,2	100,8	103,7	1	0,3	84,6	84,6	105	108	1	0,3	91,7	5,1	16,5		
89,2	89,2	100,8	103,7	1	0,3	84,6	84,6	105	108	1	0,3	91,7	5,1	16,5		
96,7	94,3	111,4	111,4	1,1	0,6	86	86	119	121,8	1	0,6	98	10	–		
96,7	94,3	111,4	111,4	1,1	0,6	86	86	119	121,8	1	0,6	98	10	–		
96,7	94,3	111,4	111,4	1,1	0,6	86	86	119	121,8	1	0,6	98	10	9,6		
96,7	94,3	111,4	111,4	1,1	0,6	86	86	119	121,8	1	0,6	98	10	9,6		

¹⁾ For calculating the initial grease fill → page 101

2.1 Angular contact ball bearings

d 80 – 85 mm

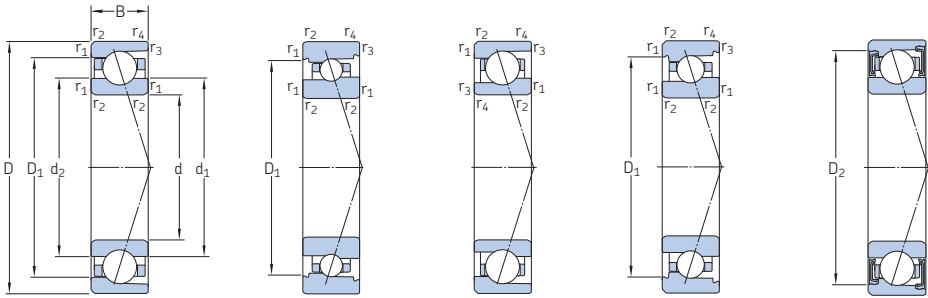

ACD, CD

ACB, CB

719 .. ACE,
719 .. CE70 .. ACE,
70 .. CE

S... 1)

Principal dimensions			Basic load ratings		Fatigue load limit P_u	Attainable speeds		Mass ²⁾	Designation	Available variants	
d	D	B	dynamic C	static C_0		Grease lubrication	Oil-air lubrication ²⁾			Sealing solution ¹⁾	Direct oil-air lubrication ³⁾
mm			kN		kN	r/min		kg	-	-	
80	125	22	32,5	26,5	1,12	13 700	21 000	0,86	7016 ACE/P4A	S	H1, L, L1
	125	22	32,5	26,5	1,12	15 500	24 000	0,77	7016 ACE/HCP4A	S	H1, L, L1
	125	22	33,8	28	1,18	15 000	24 000	0,86	7016 CE/P4A	S	H1, L, L1
	125	22	33,8	28	1,18	17 500	27 000	0,77	7016 CE/HCP4A	S	H1, L, L1
	125	22	62,4	58,5	2,45	9 500	15 000	0,85	7016 ACD/P4A	S	H1, L
	125	22	62,4	58,5	2,45	12 000	18 000	0,71	7016 ACD/HCP4A	S	H1, L
	125	22	65	61	2,55	10 000	17 000	0,85	7016 CD/P4A	S	H1, L
	125	22	65	61	2,55	13 000	20 000	0,71	7016 CD/HCP4A	S	H1, L
	140	26	81,9	72	2,9	8 500	14 000	1,45	7216 ACD/P4A	S	-
	140	26	81,9	72	2,9	10 000	17 000	1,25	7216 ACD/HCP4A	S	-
	140	26	85,2	75	3,05	9 500	16 000	1,45	7216 CD/P4A	S	-
	140	26	85,2	75	3,05	12 000	18 000	1,25	7216 CD/HCP4A	S	-
85	110	13	20,3	24	1,02	10 000	16 000	0,27	71817 ACD/P4	-	-
	110	13	20,3	24	1,02	12 000	19 000	0,24	71817 ACD/HCP4	-	-
	110	13	21,6	25,5	1,08	11 000	17 000	0,27	71817 CD/P4	-	-
	110	13	21,6	25,5	1,08	14 000	20 000	0,24	71817 CD/HCP4	-	-
	120	18	15,3	15,3	0,64	13 000	20 000	0,57	71917 ACB/P4A	S	L
	120	18	15,3	15,3	0,64	16 000	24 000	0,54	71917 ACB/HCP4A	S	L
	120	18	16,3	16,3	0,68	15 000	22 000	0,57	71917 CB/P4A	S	L
	120	18	16,3	16,3	0,68	18 000	28 000	0,54	71917 CB/HCP4A	S	L
	120	18	28,1	22	0,9	13 700	21 000	0,5	71917 ACE/P4A	S	H1, L
	120	18	28,1	22	0,9	16 500	25 000	0,42	71917 ACE/HCP4A	S	H1, L
	120	18	29,6	23,2	0,95	15 500	24 000	0,5	71917 CE/P4A	S	H1, L
	120	18	29,6	23,2	0,95	18 000	28 000	0,42	71917 CE/HCP4A	S	H1, L
	120	18	43,6	45,5	1,93	9 000	15 000	0,53	71917 ACD/P4A	S	H1, L
	120	18	43,6	45,5	1,93	11 000	18 000	0,45	71917 ACD/HCP4A	S	H1, L
	120	18	46,2	48	2,04	10 000	17 000	0,53	71917 CD/P4A	S	H1, L
	120	18	46,2	48	2,04	14 000	20 000	0,45	71917 CD/HCP4A	S	H1, L

1) Designation prefix S. For details, refer to *Sealing solutions* (→ page 136).

2) Applicable to open bearings only.

3) Designation suffix H, H1, L or L1. For details, refer to *Direct oil-air lubrication* (→ page 136).

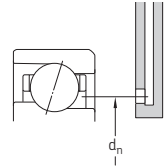
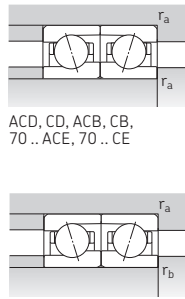
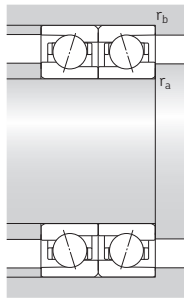
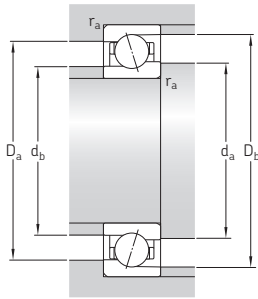

ACD, CD, ACB, CB,
70 .. ACE, 70 .. CE

719 .. ACE, 719 .. CE

Dimensions					Abutment and fillet dimensions								Reference grease quantity ¹⁾	Calculation factor	
d	d ₁	d ₂	D ₁	D ₂	r _{1,2} min.	r _{3,4} min.	d _a min.	d _b min.	D _a max.	D _b max.	r _a max.	r _b max.	d _n	G _{ref}	f ₀
mm														cm ³	-
80 cont.	95,8	93	112,6	112,6	1,1	0,6	86	86	119	120,8	1	0,6	98,5	12	-
	95,8	93	112,6	112,6	1,1	0,6	86	86	119	120,8	1	0,6	98,5	12	-
	95,8	93	112,6	112,6	1,1	0,6	86	86	119	120,8	1	0,6	98,5	12	9,4
	95,8	93	112,6	112,6	1,1	0,6	86	86	119	120,8	1	0,6	98,5	12	9,4
	93,9	93,9	111,1	114	1,1	0,6	86	86	119	121	1	0,6	96,9	11	-
	93,9	93,9	111,1	114	1,1	0,6	86	86	119	121	1	0,6	96,9	11	-
	93,9	93,9	111,1	114	1,1	0,6	86	86	119	121	1	0,6	96,9	11	15,5
	93,9	93,9	111,1	114	1,1	0,6	86	86	119	121	1	0,6	96,9	11	15,5
	99,5	99,5	120,5	124,3	2	1	91	91	129	134,4	2	1	103,4	18	-
	99,5	99,5	120,5	124,3	2	1	91	91	129	134,4	2	1	103,4	18	-
	99,5	99,5	120,5	124,3	2	1	91	91	129	134,4	2	1	103,4	18	15,1
	99,5	99,5	120,5	124,3	2	1	91	91	129	134,4	2	1	103,4	18	15,1
85	93,2	93,2	102,1	-	1	0,3	89,6	89,6	105,4	108	1	0,3	94,1	2,7	-
	93,2	93,2	102,1	-	1	0,3	89,6	89,6	105,4	108	1	0,3	94,1	2,7	-
	93,2	93,2	102,1	-	1	0,3	89,6	89,6	105,4	108	1	0,3	94,1	2,7	17,1
	93,2	93,2	102,1	-	1	0,3	89,6	89,6	105,4	108	1	0,3	94,1	2,7	17,1
	98,2	96,7	110,2	110,2	1,1	0,6	91	91	114	116,8	1	0,6	99,2	6,5	-
	98,2	96,7	110,2	110,2	1,1	0,6	91	91	114	116,8	1	0,6	99,2	6,5	-
	98,2	96,7	110,2	110,2	1,1	0,6	91	91	114	116,8	1	0,6	99,2	6,5	10
	98,2	96,7	110,2	110,2	1,1	0,6	91	91	114	116,8	1	0,6	99,2	6,5	10
	96	92,9	109,2	112,3	1,1	0,6	91	88,2	114	116,8	1	0,6	98,6	7	-
	96	92,9	109,2	112,3	1,1	0,6	91	88,2	114	116,8	1	0,6	98,6	7	-
	96	92,9	109,2	112,3	1,1	0,6	91	88,2	114	116,8	1	0,6	98,6	7	8,4
	96	92,9	109,2	112,3	1,1	0,6	91	88,2	114	116,8	1	0,6	98,6	7	8,4
	95,8	95,8	109,2	112,2	1,1	0,6	91	91	114	116	1	0,6	98,6	7,2	-
	95,8	95,8	109,2	112,2	1,1	0,6	91	91	114	116	1	0,6	98,6	7,2	-
	95,8	95,8	109,2	112,2	1,1	0,6	91	91	114	116	1	0,6	98,6	7,2	16,2
	95,8	95,8	109,2	112,2	1,1	0,6	91	91	114	116	1	0,6	98,6	7,2	16,2

¹⁾ For calculating the initial grease fill → page 101

2.1 Angular contact ball bearings

d 85 – 90 mm

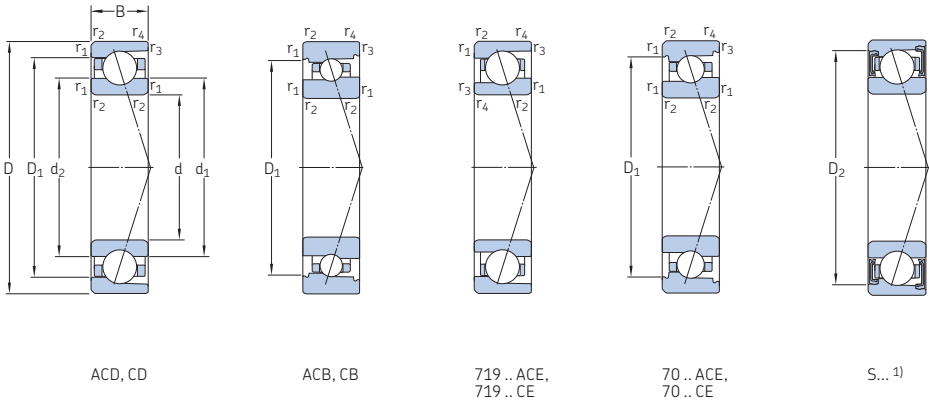

Principal dimensions	Basic load ratings		Fatigue load limit P_u	Attainable speeds		Mass ²⁾	Designation	Available variants			
	dynamic C	static C_0		Grease lubrication	Oil-air lubrication ²⁾			Sealing solution ¹⁾	Direct oil-air lubrication ³⁾		
d	D	B			r/min	kg					
mm	kN		kN				-				
85 cont.	130	22	25,1	22,4	0,915	12 000	18 000	0,96	7017 ACB/P4A	S	L
	130	22	25,1	22,4	0,915	14 000	22 000	0,9	7017 ACB/HCP4A	S	L
	130	22	27	23,6	0,965	13 000	20 000	0,96	7017 CB/P4A	S	L
	130	22	27	23,6	0,965	16 000	24 000	0,9	7017 CB/HCP4A	S	L
	130	22	32,5	28	1,14	13 000	20 000	0,9	7017 ACE/P4A	S	H1, L, L1
	130	22	32,5	28	1,14	15 000	23 000	0,81	7017 ACE/HCP4A	S	H1, L, L1
	130	22	34,5	29	1,2	14 000	22 000	0,9	7017 CE/P4A	S	H1, L, L1
	130	22	34,5	29	1,2	16 500	26 000	0,81	7017 CE/HCP4A	S	H1, L, L1
	130	22	63,7	62	2,5	9 000	14 000	0,9	7017 ACD/P4A	S	H1, L
	130	22	63,7	62	2,5	11 000	17 000	0,75	7017 ACD/HCP4A	S	H1, L
	130	22	67,6	65,5	2,65	10 000	16 000	0,9	7017 CD/P4A	S	H1, L
	130	22	67,6	65,5	2,65	12 000	19 000	0,75	7017 CD/HCP4A	S	H1, L
	150	28	95,6	85	3,35	8 000	13 000	1,85	7217 ACD/P4A	-	-
	150	28	95,6	85	3,35	9 500	16 000	1,55	7217 ACD/HCP4A	-	-
150	28	99,5	88	3,45	9 000	15 000	1,85	7217 CD/P4A	-	-	
150	28	99,5	88	3,45	11 000	17 000	1,55	7217 CD/HCP4A	-	-	
90	115	13	20,3	25	1,04	10 000	15 000	0,28	71818 ACD/P4	-	-
	115	13	20,3	25	1,04	12 000	18 000	0,25	71818 ACD/HCP4	-	-
	115	13	21,6	26,5	1,1	11 000	17 000	0,28	71818 CD/P4	-	-
	115	13	21,6	26,5	1,1	13 000	20 000	0,25	71818 CD/HCP4	-	-
	125	18	16,8	16,6	0,68	12 000	19 000	0,59	71918 ACB/P4A	S	L
	125	18	16,8	16,6	0,68	15 000	22 000	0,56	71918 ACB/HCP4A	S	L
	125	18	17,8	17,6	0,72	14 000	22 000	0,59	71918 CB/P4A	S	L
	125	18	17,8	17,6	0,72	16 000	26 000	0,56	71918 CB/HCP4A	S	L
	125	18	28,6	23,2	0,915	13 000	20 000	0,54	71918 ACE/P4A	S	H1, L
	125	18	28,6	23,2	0,915	15 500	24 000	0,46	71918 ACE/HCP4A	S	H1, L
	125	18	30,2	24,5	0,965	14 500	22 000	0,54	71918 CE/P4A	S	H1, L
	125	18	30,2	24,5	0,965	17 000	27 000	0,46	71918 CE/HCP4A	S	H1, L

1) Designation prefix S. For details, refer to *Sealing solutions* (→ page 136).

2) Applicable to open bearings only.

3) Designation suffix H, H1, L or L1. For details, refer to *Direct oil-air lubrication* (→ page 136).

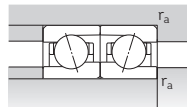
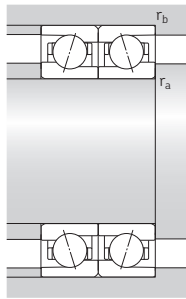
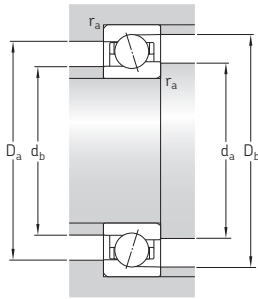

ACD, CD, ACB, CB,
70 .. ACE, 70 .. CE

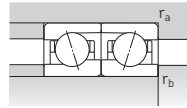

719 .. ACE, 719 .. CE

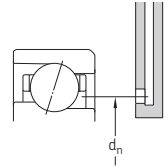

Dimensions					Abutment and fillet dimensions									Reference grease quantity ¹⁾	Calculation factor	
d	d ₁	d ₂	D ₁	D ₂	r _{1,2} min.	r _{3,4} min.	d _a min.	d _b min.	D _a max.	D _b max.	r _a max.	r _b max.	d _n	G _{ref}	f ₀	
mm															cm ³	–
85 cont.	101,7	99,3	116,4	116,4	1,1	0,6	91	91	124	126,8	1	0,6	103	11	–	
	101,7	99,3	116,4	116,4	1,1	0,6	91	91	124	126,8	1	0,6	103	11	–	
	101,7	99,3	116,4	116,4	1,1	0,6	91	91	124	126,8	1	0,6	103	11	9,6	
	101,7	99,3	116,4	116,4	1,1	0,6	91	91	124	126,8	1	0,6	103	11	9,6	
	100,8	98	117,6	117,6	1,1	0,6	91	91	124	125,8	1	0,6	103,5	12	–	
	100,8	98	117,6	117,6	1,1	0,6	91	91	124	125,8	1	0,6	103,5	12	–	
	100,8	98	117,6	117,6	1,1	0,6	91	91	124	125,8	1	0,6	103,5	12	9,5	
	100,8	98	117,6	117,6	1,1	0,6	91	91	124	125,8	1	0,6	103,5	12	9,5	
	98,9	98,9	116,1	119,1	1,1	0,6	91	91	124	126	1	0,6	101,9	12	–	
	98,9	98,9	116,1	119,1	1,1	0,6	91	91	124	126	1	0,6	101,9	12	–	
	98,9	98,9	116,1	119,1	1,1	0,6	91	91	124	126	1	0,6	101,9	12	15,7	
	98,9	98,9	116,1	119,1	1,1	0,6	91	91	124	126	1	0,6	101,9	12	15,7	
106,5	106,5	129,5	–	2	1	96	96	139	144,4	2	1	111,5	22	–		
106,5	106,5	129,5	–	2	1	96	96	139	144,4	2	1	111,5	22	–		
106,5	106,5	129,5	–	2	1	96	96	139	144,4	2	1	111,5	22	14,9		
106,5	106,5	129,5	–	2	1	96	96	139	144,4	2	1	111,5	22	14,9		
90	98,2	98,2	107,1	–	1	0,3	94,6	94,6	110,4	113	1	0,3	99,1	2,9	–	
	98,2	98,2	107,1	–	1	0,3	94,6	94,6	110,4	113	1	0,3	99,1	2,9	–	
	98,2	98,2	107,1	–	1	0,3	94,6	94,6	110,4	113	1	0,3	99,1	2,9	17,2	
	98,2	98,2	107,1	–	1	0,3	94,6	94,6	110,4	113	1	0,3	99,1	2,9	17,2	
	103	101,4	115	115	1,1	0,6	96	96	119	121,8	1	0,6	103,9	7,4	–	
	103	101,4	115	115	1,1	0,6	96	96	119	121,8	1	0,6	103,9	7,4	–	
	103	101,4	115	115	1,1	0,6	96	96	119	121,8	1	0,6	103,9	7,4	10	
	103	101,4	115	115	1,1	0,6	96	96	119	121,8	1	0,6	103,9	7,4	10	
	101	97,9	114,2	117,3	1,1	0,6	96	93,2	119	121,8	1	0,6	103,5	7	–	
	101	97,9	114,2	117,3	1,1	0,6	96	93,2	119	121,8	1	0,6	103,5	7	–	
	101	97,9	114,2	117,3	1,1	0,6	96	93,2	119	121,8	1	0,6	103,5	7	8,5	
	101	97,9	114,2	117,3	1,1	0,6	96	93,2	119	121,8	1	0,6	103,5	7	8,5	

¹⁾ For calculating the initial grease fill → page 101

2.1 Angular contact ball bearings

d 90 – 95 mm

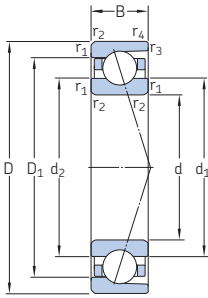

ACD, CD

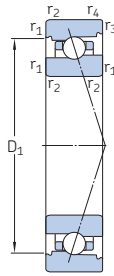

ACB, CB

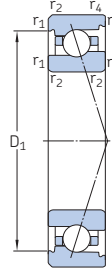

70 .. ACE,
70 .. CE

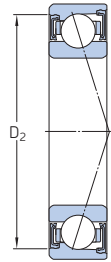

S... 1)

Principal dimensions	Basic load ratings		Fatigue load limit P_u	Attainable speeds		Mass ²⁾	Designation	Available variants			
	d	D		dynamic C	static C_0			Grease lubrication	Oil-air lubrication ²⁾	Sealing solution ¹⁾	Direct oil-air lubrication ³⁾
mm			kN		kN		r/min	kg	–	–	
90	125	18	44,2	48	1,96	8 500	14 000	0,55	71918 ACD/P4A	S	H1, L
	125	18	44,2	48	1,96	10 000	17 000	0,47	71918 ACD/HCP4A	S	H1, L
	125	18	47,5	51	2,08	9 500	16 000	0,55	71918 CD/P4A	S	H1, L
	125	18	47,5	51	2,08	13 000	19 000	0,47	71918 CD/HCP4A	S	H1, L
	140	24	27	23,6	0,93	11 000	17 000	1,25	7018 ACB/P4A	S	L
	140	24	27	23,6	0,93	13 000	20 000	1,2	7018 ACB/HCP4A	S	L
	140	24	29,1	25	0,98	12 000	19 000	1,25	7018 CB/P4A	S	L
	140	24	29,1	25	0,98	15 000	24 000	1,2	7018 CB/HCP4A	S	L
	140	24	33,8	30	1,2	12 000	19 000	1,2	7018 ACE/P4A	S	H1, L, L1
	140	24	33,8	30	1,2	14 000	22 000	1,1	7018 ACE/HCP4A	S	H1, L, L1
	140	24	35,8	32	1,27	13 300	21 000	1,2	7018 CE/P4A	S	H1, L, L1
	140	24	35,8	32	1,27	15 500	24 000	1,1	7018 CE/HCP4A	S	H1, L, L1
	140	24	74,1	72	2,85	8 500	13 000	1,15	7018 ACD/P4A	S	H1, L
	140	24	74,1	72	2,85	10 000	16 000	1	7018 ACD/HCP4A	S	H1, L
	140	24	79,3	76,5	3	9 000	15 000	1,15	7018 CD/P4A	S	H1, L
	140	24	79,3	76,5	3	11 000	18 000	1	7018 CD/HCP4A	S	H1, L
95	160	30	121	106	4,05	7 500	12 000	2,25	7218 ACD/P4A	–	–
	160	30	121	106	4,05	9 000	15 000	1,85	7218 ACD/HCP4A	–	–
	160	30	127	112	4,25	8 500	14 000	2,25	7218 CD/P4A	–	–
	160	30	127	112	4,25	10 000	16 000	1,85	7218 CD/HCP4A	–	–
	120	13	20,8	25,5	1,06	9 500	14 000	0,29	71819 ACD/P4	–	–
	120	13	20,8	25,5	1,06	11 000	17 000	0,26	71819 ACD/HCP4	–	–
	120	13	22,1	27,5	1,12	10 000	16 000	0,29	71819 CD/P4	–	–
	120	13	22,1	27,5	1,12	12 000	19 000	0,26	71819 CD/HCP4	–	–
	130	18	17,2	17,6	0,71	12 000	18 000	0,61	71919 ACB/P4A	S	L
	130	18	17,2	17,6	0,71	14 000	22 000	0,58	71919 ACB/HCP4A	S	L
	130	18	18,2	18,6	0,75	13 000	20 000	0,61	71919 CB/P4A	S	L
	130	18	18,2	18,6	0,75	16 000	24 000	0,58	71919 CB/HCP4A	S	L

1) Designation prefix S. For details, refer to *Sealing solutions* (→ page 136).

2) Applicable to open bearings only.

3) Designation suffix H, H1, L or L1. For details, refer to *Direct oil-air lubrication* (→ page 136).

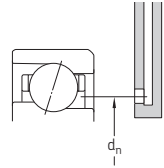
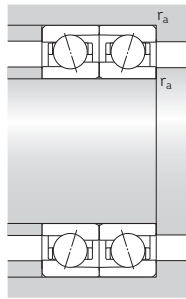
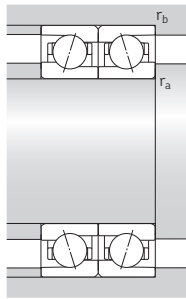
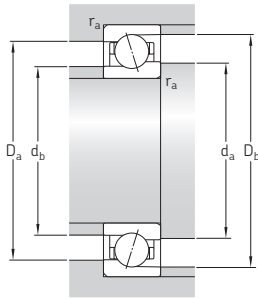

Dimensions					Abutment and fillet dimensions								Reference grease quantity ¹⁾	Calculation factor	
d	d ₁	d ₂	D ₁	D ₂	r _{1,2} min.	r _{3,4} min.	d _a min.	d _b min.	D _a max.	D _b max.	r _a max.	r _b max.	d _n	G _{ref}	f ₀
mm														cm ³	-
90	100,8	100,8	114,2	117,2	1,1	0,6	96	96	119	121	1	0,6	103,3	7,5	-
	100,8	100,8	114,2	117,2	1,1	0,6	96	96	119	121	1	0,6	103,3	7,5	-
	100,8	100,8	114,2	117,2	1,1	0,6	96	96	119	121	1	0,6	103,3	7,5	16,3
	100,8	100,8	114,2	117,2	1,1	0,6	96	96	119	121	1	0,6	103,3	7,5	16,3
	108,7	106,1	125	125	1,5	1	97	97	133	135,4	1,5	1	110	14	-
	108,7	106,1	125	125	1,5	1	97	97	133	135,4	1,5	1	110	14	-
	108,7	106,1	125	125	1,5	1	97	97	133	135,4	1,5	1	110	14	9,7
	108,7	106,1	125	125	1,5	1	97	97	133	135,4	1,5	1	110	14	9,7
	108,3	105,5	125,2	125,2	1,5	1	97	97	133	134,4	1,5	1	111	14	-
	108,3	105,5	125,2	125,2	1,5	1	97	97	133	134,4	1,5	1	111	14	-
	108,3	105,5	125,2	125,2	1,5	1	97	97	133	134,4	1,5	1	111	14	9,6
	108,3	105,5	125,2	125,2	1,5	1	97	97	133	134,4	1,5	1	111	14	9,6
105,4	105,4	124,6	128,3	1,5	1	97	97	133	136	1,5	1	108,7	15	-	
105,4	105,4	124,6	128,3	1,5	1	97	97	133	136	1,5	1	108,7	15	-	
105,4	105,4	124,6	128,3	1,5	1	97	97	133	136	1,5	1	108,7	15	15,6	
105,4	105,4	124,6	128,3	1,5	1	97	97	133	136	1,5	1	108,7	15	15,6	
111,6	111,6	138,4	-	2	1	101	101	149	154,4	2	1	117,5	28	-	
111,6	111,6	138,4	-	2	1	101	101	149	154,4	2	1	117,5	28	-	
111,6	111,6	138,4	-	2	1	101	101	149	154,4	2	1	117,5	28	14,6	
111,6	111,6	138,4	-	2	1	101	101	149	154,4	2	1	117,5	28	14,6	
95	103,2	103,2	112,1	-	1	0,3	99,6	99,6	115,4	118	1	0,3	104,1	3,1	-
	103,2	103,2	112,1	-	1	0,3	99,6	99,6	115,4	118	1	0,3	104,1	3,1	-
	103,2	103,2	112,1	-	1	0,3	99,6	99,6	115,4	118	1	0,3	104,1	3,1	17,3
	103,2	103,2	112,1	-	1	0,3	99,6	99,6	115,4	118	1	0,3	104,1	3,1	17,3
	107,9	106,4	120,7	120,7	1,1	0,6	101	101	124	126,8	1	0,6	109	7,5	-
	107,9	106,4	120,7	120,7	1,1	0,6	101	101	124	126,8	1	0,6	109	7,5	-
	107,9	106,4	120,7	120,7	1,1	0,6	101	101	124	126,8	1	0,6	109	7,5	10
	107,9	106,4	120,7	120,7	1,1	0,6	101	101	124	126,8	1	0,6	109	7,5	10

¹⁾ For calculating the initial grease fill → page 101

2.1 Angular contact ball bearings d 95 – 100 mm

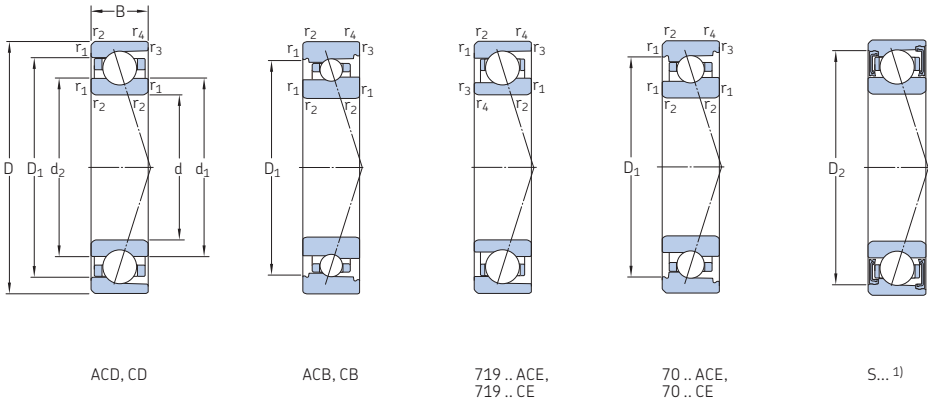

Principal dimensions	Basic load ratings		Fatigue load limit P_u	Attainable speeds		Mass ²⁾	Designation	Available variants			
	dynamic C	static C_0		Grease lubrication	Oil-air lubrication ²⁾			Sealing solution ¹⁾	Direct oil-air lubrication ³⁾		
d	D	B									
mm			kN	kN	r/min	kg	–	–			
95 cont.	130	18	29,1	24	0,93	12 300	19 000	0,56	71919 ACE/P4A	S	H1, L
	130	18	29,1	24	0,93	15 000	23 000	0,48	71919 ACE/HCP4A	S	H1, L
	130	18	30,7	25,5	0,98	14 000	21 000	0,56	71919 CE/P4A	S	H1, L
	130	18	30,7	25,5	0,98	16 000	25 000	0,48	71919 CE/HCP4A	S	H1, L
	130	18	46,2	52	2,08	8 500	14 000	0,58	71919 ACD/P4A	S	H1, L
	130	18	46,2	52	2,08	9 500	16 000	0,5	71919 ACD/HCP4A	S	H1, L
	130	18	49,4	55	2,2	9 000	15 000	0,58	71919 CD/P4A	S	H1, L
	130	18	49,4	55	2,2	12 000	18 000	0,5	71919 CD/HCP4A	S	H1, L
	145	24	27,6	24,5	0,95	11 000	16 000	1,3	7019 ACB/P4A	S	L
	145	24	27,6	24,5	0,95	13 000	19 000	1,25	7019 ACB/HCP4A	S	L
	145	24	29,6	26	1	12 000	18 000	1,3	7019 CB/P4A	S	L
	145	24	29,6	26	1	14 000	22 000	1,25	7019 CB/HCP4A	S	L
	145	24	41,6	36	1,4	11 500	18 000	1,2	7019 ACE/P4A	S	H1, L, L1
	145	24	41,6	36	1,4	13 300	20 500	1,1	7019 ACE/HCP4A	S	H1, L, L1
	145	24	44,2	38	1,46	12 700	20 000	1,2	7019 CE/P4A	S	H1, L, L1
	145	24	44,2	38	1,46	15 000	23 000	1,1	7019 CE/HCP4A	S	H1, L, L1
145	24	76,1	76,5	2,9	8 000	13 000	1,2	7019 ACD/P4A	S	H1, L	
145	24	76,1	76,5	2,9	10 000	16 000	1	7019 ACD/HCP4A	S	H1, L	
145	24	81,9	80	3,1	8 500	14 000	1,2	7019 CD/P4A	S	H1, L	
145	24	81,9	80	3,1	11 000	17 000	1	7019 CD/HCP4A	S	H1, L	
170	32	133	114	4,25	7 500	12 000	2,7	7219 ACD/P4A	–	–	
170	32	133	114	4,25	8 500	14 000	2,2	7219 ACD/HCP4A	–	–	
170	32	138	120	4,4	8 000	13 000	2,7	7219 CD/P4A	–	–	
170	32	138	120	4,4	9 500	15 000	2,2	7219 CD/HCP4A	–	–	
100	125	13	21,2	27,5	1,1	8 500	13 000	0,31	71820 ACD/P4	–	–
	125	13	21,2	27,5	1,1	10 000	15 000	0,28	71820 ACD/HCP4	–	–
	125	13	22,5	29	1,16	9 000	14 000	0,31	71820 CD/P4	–	–
	125	13	22,5	29	1,16	11 000	17 000	0,28	71820 CD/HCP4	–	–

1) Designation prefix S. For details, refer to *Sealing solutions* (→ page 136).

2) Applicable to open bearings only.

3) Designation suffix H, H1, L or L1. For details, refer to *Direct oil-air lubrication* (→ page 136).

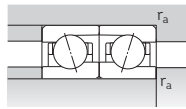
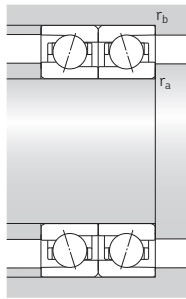
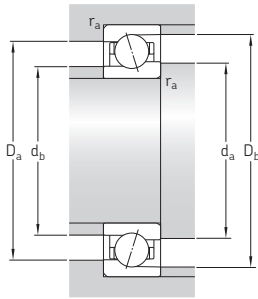

ACD, CD, ACB, CB,
70 .. ACE, 70 .. CE

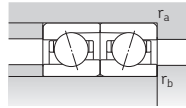

719 .. ACE, 719 .. CE

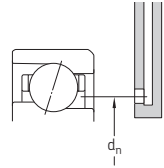

Dimensions					Abutment and fillet dimensions								Reference grease quantity ¹⁾	Calculation factor	
d	d ₁	d ₂	D ₁	D ₂	r _{1,2} min.	r _{3,4} min.	d _a min.	d _b min.	D _a max.	D _b max.	r _a max.	r _b max.	d _n	G _{ref} cm ³	f ₀
mm															
95 cont.	106	102,9	119,2	122,6	1,1	0,6	101	98,2	124	126,8	1	0,6	108,5	7,3	–
	106	102,9	119,2	122,6	1,1	0,6	101	98,2	124	126,8	1	0,6	108,5	7,3	–
	106	102,9	119,2	122,6	1,1	0,6	101	98,2	124	126,8	1	0,6	108,5	7,3	8,6
	106	102,9	119,2	122,6	1,1	0,6	101	98,2	124	126,8	1	0,6	108,5	7,3	8,6
	105,8	105,8	119,2	122,2	1,1	0,6	101	101	124	126	1	0,6	108,6	7,8	–
	105,8	105,8	119,2	122,2	1,1	0,6	101	101	124	126	1	0,6	108,6	7,8	–
	105,8	105,8	119,2	122,2	1,1	0,6	101	101	124	126	1	0,6	108,6	7,8	16,4
	105,8	105,8	119,2	122,2	1,1	0,6	101	101	124	126	1	0,6	108,6	7,8	16,4
	113,7	111,2	130	130	1,5	1	102	102	138	140,4	1,5	1	115	15	–
	113,7	111,2	130	130	1,5	1	102	102	138	140,4	1,5	1	115	15	–
	113,7	111,2	130	130	1,5	1	102	102	138	140,4	1,5	1	115	15	9,7
	113,7	111,2	130	130	1,5	1	102	102	138	140,4	1,5	1	115	15	9,7
112,4	109,2	131	131	1,5	1	102	102	138	139,4	1,5	1	115,4	17	–	
112,4	109,2	131	131	1,5	1	102	102	138	139,4	1,5	1	115,4	17	–	
112,4	109,2	131	131	1,5	1	102	102	138	139,4	1,5	1	115,4	17	9,4	
112,4	109,2	131	131	1,5	1	102	102	138	139,4	1,5	1	115,4	17	9,4	
110,4	110,4	129,6	133,3	1,5	1	102	102	138	141	1,5	1	113,7	16	–	
110,4	110,4	129,6	133,3	1,5	1	102	102	138	141	1,5	1	113,7	16	–	
110,4	110,4	129,6	133,3	1,5	1	102	102	138	141	1,5	1	113,7	16	15,7	
110,4	110,4	129,6	133,3	1,5	1	102	102	138	141	1,5	1	113,7	16	15,7	
118,1	118,1	146,9	–	2,1	1,1	107	107	158	163	2	1	124,4	34	–	
118,1	118,1	146,9	–	2,1	1,1	107	107	158	163	2	1	124,4	34	–	
118,1	118,1	146,9	–	2,1	1,1	107	107	158	163	2	1	124,4	34	14,6	
118,1	118,1	146,9	–	2,1	1,1	107	107	158	163	2	1	124,4	34	14,6	
100	108,2	108,2	117	–	1	0,3	104,6	104,6	120,4	123	1	0,3	109,1	3,2	–
	108,2	108,2	117	–	1	0,3	104,6	104,6	120,4	123	1	0,3	109,1	3,2	–
	108,2	108,2	117	–	1	0,3	104,6	104,6	120,4	123	1	0,3	109,1	3,2	17,4
	108,2	108,2	117	–	1	0,3	104,6	104,6	120,4	123	1	0,3	109,1	3,2	17,4

¹⁾ For calculating the initial grease fill → page 101

2.1 Angular contact ball bearings

d 100 mm

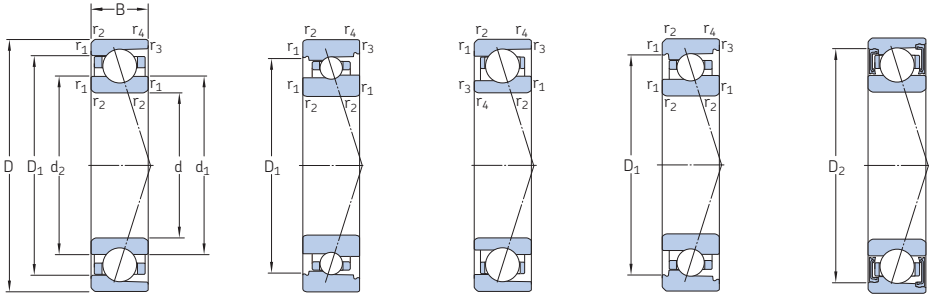

ACD, CD

ACB, CB

719 .. ACE,
719 .. CE

70 .. ACE,
70 .. CE

S... 1)

Principal dimensions	Basic load ratings		Fatigue load limit P_u	Attainable speeds		Mass ²⁾	Designation	Available variants			
	dynamic C	static C_0		Grease lubrication	Oil-air lubrication ²⁾			Sealing solution ¹⁾	Direct oil-air lubrication ³⁾		
d	D	B									
mm			kN		r/min	kg	-	-			
100 cont.	140	20	20,8	21,2	0,815	11 000	17 000	0,85	71920 ACB/P4A	S	L
	140	20	20,8	21,2	0,815	13 000	20 000	0,8	71920 ACB/HCP4A	S	L
	140	20	21,6	22,4	0,865	12 000	19 000	0,85	71920 CB/P4A	S	L
	140	20	21,6	22,4	0,865	15 000	24 000	0,8	71920 CB/HCP4A	S	L
	140	20	36,4	30	1,14	11 500	18 000	0,77	71920 ACE/P4A	S	H1, L
	140	20	36,4	30	1,14	13 700	22 000	0,65	71920 ACE/HCP4A	S	H1, L
	140	20	39	31,5	1,2	13 300	20 500	0,77	71920 CE/P4A	S	H1, L
	140	20	39	31,5	1,2	15 500	24 000	0,65	71920 CE/HCP4A	S	H1, L
	140	20	57,2	63	2,4	8 000	13 000	0,8	71920 ACD/P4A	S	H1, L
	140	20	57,2	63	2,4	9 000	15 000	0,67	71920 ACD/HCP4A	S	H1, L
	140	20	60,5	65,5	2,55	8 500	14 000	0,8	71920 CD/P4A	S	H1, L
	140	20	60,5	65,5	2,55	11 000	17 000	0,67	71920 CD/HCP4A	S	H1, L
150	24	28,1	25,5	0,98	10 000	15 000	1,35	7020 ACB/P4A	S	L	
	150	24	28,1	25,5	0,98	12 000	18 000	1,3	7020 ACB/HCP4A	S	L
	150	24	29,6	27	1,02	11 000	17 000	1,35	7020 CB/P4A	S	L
	150	24	29,6	27	1,02	13 000	20 000	1,3	7020 CB/HCP4A	S	L
	150	24	42,3	38	1,43	11 200	17 500	1,25	7020 ACE/P4A	S	H1, L, L1
	150	24	42,3	38	1,43	12 700	20 000	1,1	7020 ACE/HCP4A	S	H1, L, L1
	150	24	44,9	40	1,5	12 300	19 000	1,25	7020 CE/P4A	S	H1, L, L1
	150	24	44,9	40	1,5	14 500	22 000	1,1	7020 CE/HCP4A	S	H1, L, L1
	150	24	79,3	80	3,05	8 000	12 000	1,25	7020 ACD/P4A	S	H1, L
	150	24	79,3	80	3,05	9 500	15 000	1,05	7020 ACD/HCP4A	S	H1, L
	150	24	83,2	85	3,2	8 500	14 000	1,25	7020 CD/P4A	S	H1, L
	150	24	83,2	85	3,2	10 000	16 000	1,05	7020 CD/HCP4A	S	H1, L
180	34	148	129	4,65	7 000	11 000	3,25	7220 ACD/P4A	-	-	
	180	34	148	129	4,65	8 000	13 000	2,65	7220 ACD/HCP4A	-	-
	180	34	156	137	4,9	7 500	12 000	3,25	7220 CD/P4A	-	-
	180	34	156	137	4,9	9 000	14 000	2,65	7220 CD/HCP4A	-	-

1) Designation prefix S. For details, refer to *Sealing solutions* (→ page 136).

2) Applicable to open bearings only.

3) Designation suffix H, H1, L or L1. For details, refer to *Direct oil-air lubrication* (→ page 136).

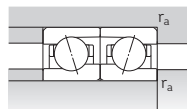
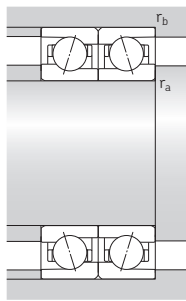
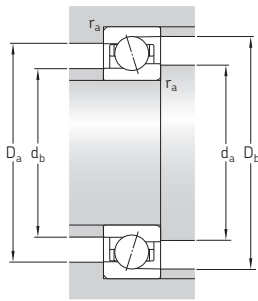

ACD, CD, ACB, CB,
70 .. ACE, 70 .. CE

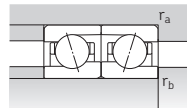

719 .. ACE, 719 .. CE

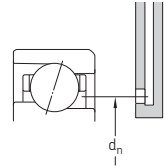

Dimensions					Abutment and fillet dimensions									Reference grease quantity ¹⁾	Calculation factor	
d	d ₁	d ₂	D ₁	D ₂	r _{1,2} min.	r _{3,4} min.	d _a min.	d _b min.	D _a max.	D _b max.	r _a max.	r _b max.	d _n	G _{ref}	f ₀	
mm															cm ³	-
100 cont.	114,9	113,2	128,7	128,7	1,1	0,6	106	106	134	136,8	1	0,6	116,1	10	-	
	114,9	113,2	128,7	128,7	1,1	0,6	106	106	134	136,8	1	0,6	116,1	10	-	
	114,9	113,2	128,7	128,7	1,1	0,6	106	106	134	136,8	1	0,6	116,1	10	10	
	114,9	113,2	128,7	128,7	1,1	0,6	106	106	134	136,8	1	0,6	116,1	10	10	
	112,4	109	127,5	130,9	1,1	0,6	106	103,2	134	136,8	1	0,6	115,4	10	-	
	112,4	109	127,5	130,9	1,1	0,6	106	103,2	134	136,8	1	0,6	115,4	10	-	
	112,4	109	127,5	130,9	1,1	0,6	106	103,2	134	136,8	1	0,6	115,4	10	8,5	
	112,4	109	127,5	130,9	1,1	0,6	106	103,2	134	136,8	1	0,6	115,4	10	8,5	
	112,3	112,3	127,7	130,7	1,1	0,6	106	106	134	136	1	0,6	115,6	11	-	
	112,3	112,3	127,7	130,7	1,1	0,6	106	106	134	136	1	0,6	115,6	11	-	
	112,3	112,3	127,7	130,7	1,1	0,6	106	106	134	136	1	0,6	115,6	11	16,3	
	112,3	112,3	127,7	130,7	1,1	0,6	106	106	134	136	1	0,6	115,6	11	16,3	
	118,7	116,2	135	135	1,5	1	107	107	143	145,4	1,5	1	120	15	-	
	118,7	116,2	135	135	1,5	1	107	107	143	145,4	1,5	1	120	15	-	
	118,7	116,2	135	135	1,5	1	107	107	143	145,4	1,5	1	120	15	9,8	
	118,7	116,2	135	135	1,5	1	107	107	143	145,4	1,5	1	120	15	9,8	
	117,4	114,2	136	136	1,5	1	107	107	143	144,4	1,5	1	120,4	17	-	
	117,4	114,2	136	136	1,5	1	107	107	143	144,4	1,5	1	120,4	17	-	
	117,4	114,2	136	136	1,5	1	107	107	143	144,4	1,5	1	120,4	17	9,5	
	117,4	114,2	136	136	1,5	1	107	107	143	144,4	1,5	1	120,4	17	9,5	
	115,4	115,4	134,6	138,2	1,5	1	107	107	143	146	1,5	1	118,7	16	-	
	115,4	115,4	134,6	138,2	1,5	1	107	107	143	146	1,5	1	118,7	16	-	
	115,4	115,4	134,6	138,2	1,5	1	107	107	143	146	1,5	1	118,7	16	15,8	
	115,4	115,4	134,6	138,2	1,5	1	107	107	143	146	1,5	1	118,7	16	15,8	
	124,7	124,7	155,3	-	2,1	1,1	112	112	168	173	2	1	131,4	41	-	
	124,7	124,7	155,3	-	2,1	1,1	112	112	168	173	2	1	131,4	41	-	
	124,7	124,7	155,3	-	2,1	1,1	112	112	168	173	2	1	131,4	41	14,5	
	124,7	124,7	155,3	-	2,1	1,1	112	112	168	173	2	1	131,4	41	14,5	

¹⁾ For calculating the initial grease fill → page 101

2.1 Angular contact ball bearings

d 105 – 110 mm

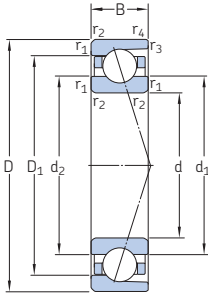

ACD, CD

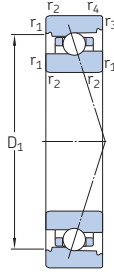

ACB, CB

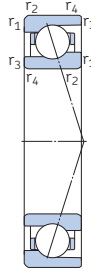

719 .. ACE,
719 .. CE

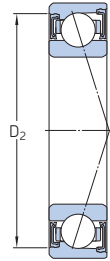

S... 1)

Principal dimensions	Basic load ratings		Fatigue load limit P_u	Attainable speeds		Mass ²⁾	Designation	Available variants			
	dynamic C	static C_0		Grease lubrication	Oil-air lubrication ²⁾			Sealing solution ¹⁾	Direct oil-air lubrication ³⁾		
d D B	kN		kN	r/min		kg	-	-			
mm	kN		kN	r/min		kg	-	-			
105	130	13	21,6	28,5	1,1	8 000	12 000	0,32	71821 ACD/P4	-	-
	130	13	21,6	28,5	1,1	9 500	15 000	0,29	71821 ACD/HCP4	-	-
	130	13	22,9	30	1,18	9 000	14 000	0,32	71821 CD/P4	-	-
	130	13	22,9	30	1,18	11 000	16 000	0,29	71821 CD/HCP4	-	-
	145	20	57,2	65,5	2,5	7 500	12 000	0,82	71921 ACD/P4A	S	H1, L
	145	20	57,2	65,5	2,5	9 000	15 000	0,7	71921 ACD/HCP4A	S	H1, L
	145	20	61,8	69,5	2,6	8 500	14 000	0,82	71921 CD/P4A	S	H1, L
	145	20	61,8	69,5	2,6	10 000	16 000	0,7	71921 CD/HCP4A	S	H1, L
	160	26	90,4	93	3,4	7 500	12 000	1,6	7021 ACD/P4A	S	H1, L
	160	26	90,4	93	3,4	9 000	14 000	1,3	7021 ACD/HCP4A	S	H1, L
	160	26	95,6	96,5	3,6	8 000	13 000	1,6	7021 CD/P4A	S	H1, L
	160	26	95,6	96,5	3,6	10 000	15 000	1,3	7021 CD/HCP4A	S	H1, L
110	190	36	163	146	5,1	6 700	10 000	3,85	7221 ACD/P4A	-	-
	190	36	163	146	5,1	7 500	12 000	3,15	7221 ACD/HCP4A	-	-
	190	36	172	153	5,3	7 500	12 000	3,85	7221 CD/P4A	-	-
	190	36	172	153	5,3	9 000	14 000	3,15	7221 CD/HCP4A	-	-
	140	16	30,2	38	1,46	7 500	12 000	0,51	71822 ACD/P4	-	-
	140	16	30,2	38	1,46	9 000	14 000	0,45	71822 ACD/HCP4	-	-
	140	16	31,9	40,5	1,53	8 000	13 000	0,51	71822 CD/P4	-	-
	140	16	31,9	40,5	1,53	10 000	15 000	0,45	71822 CD/HCP4	-	-
	150	20	24,7	25,5	0,95	10 000	15 000	0,9	71922 ACB/P4A	S	L
	150	20	24,7	25,5	0,95	12 000	19 000	0,84	71922 ACB/HCP4A	S	L
	150	20	26	27	1	11 000	17 000	0,9	71922 CB/P4A	S	L
	150	20	26	27	1	14 000	22 000	0,84	71922 CB/HCP4A	S	L
150	20	37,7	32,5	1,18	10 300	16 000	0,83	71922 ACE/P4A	S	H1, L	
150	20	37,7	32,5	1,18	12 300	19 000	0,7	71922 ACE/HCP4A	S	H1, L	
150	20	39,7	34,5	1,25	12 000	18 000	0,83	71922 CE/P4A	S	H1, L	
150	20	39,7	34,5	1,25	14 000	22 000	0,7	71922 CE/HCP4A	S	H1, L	

1) Designation prefix S. For details, refer to *Sealing solutions* (→ page 136).

2) Applicable to open bearings only.

3) Designation suffix H, H1, L or L1. For details, refer to *Direct oil-air lubrication* (→ page 136).

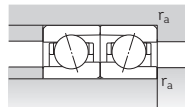
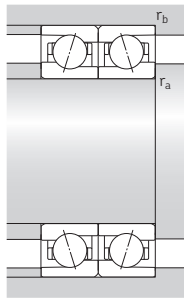
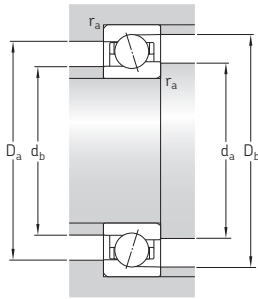

ACD, CD, ACB, CB

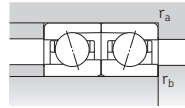

719 .. ACE, 719 .. CE

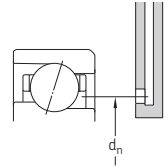

Dimensions					Abutment and fillet dimensions								Reference grease quantity ¹⁾	Calculation factor		
d	d ₁	d ₂	D ₁	D ₂	r _{1,2} min.	r _{3,4} min.	d _a min.	d _b min.	D _a max.	D _b max.	r _a max.	r _b max.	d _n	G _{ref}	f ₀	
mm															cm ³	–
105	113,2	113,2	122	–	1	0,3	109,6	109,6	125,4	128	1	0,3	114,6	4	–	
	113,2	113,2	122	–	1	0,3	109,6	109,6	125,4	128	1	0,3	114,6	4	–	
	113,2	113,2	122	–	1	0,3	109,6	109,6	125,4	128	1	0,3	114,6	4	17,4	
	113,2	113,2	122	–	1	0,3	109,6	109,6	125,4	128	1	0,3	114,6	4	17,4	
	117,3	117,3	132,7	135,7	1,1	0,6	111	111	139	141	1	0,6	120,6	11	–	
	117,3	117,3	132,7	135,7	1,1	0,6	111	111	139	141	1	0,6	120,6	11	–	
	117,3	117,3	132,7	135,7	1,1	0,6	111	111	139	141	1	0,6	120,6	11	16,4	
	117,3	117,3	132,7	135,7	1,1	0,6	111	111	139	141	1	0,6	120,6	11	16,4	
	121,9	121,9	143,1	146,8	2	1	114	114	151	155	2	1	125,6	20	–	
	121,9	121,9	143,1	146,8	2	1	114	114	151	155	2	1	125,6	20	–	
	121,9	121,9	143,1	146,8	2	1	114	114	151	155	2	1	125,6	20	15,7	
	121,9	121,9	143,1	146,8	2	1	114	114	151	155	2	1	125,6	20	15,7	
110	131,2	131,2	163,8	–	2,1	1,1	117	117	178	183	2	1	138,4	48	–	
	131,2	131,2	163,8	–	2,1	1,1	117	117	178	183	2	1	138,4	48	–	
	131,2	131,2	163,8	–	2,1	1,1	117	117	178	183	2	1	138,4	48	14,5	
	131,2	131,2	163,8	–	2,1	1,1	117	117	178	183	2	1	138,4	48	14,5	
	119,8	119,8	130,6	–	1	0,3	114,6	114,6	135,4	138	1	0,3	120,9	5,1	–	
	119,8	119,8	130,6	–	1	0,3	114,6	114,6	135,4	138	1	0,3	120,9	5,1	–	
	119,8	119,8	130,6	–	1	0,3	114,6	114,6	135,4	138	1	0,3	120,9	5,1	17,2	
	119,8	119,8	130,6	–	1	0,3	114,6	114,6	135,4	138	1	0,3	120,9	5,1	17,2	
	124,4	122,5	139	139	1,1	0,6	116	116	144	146,8	1	0,6	125,7	11	–	
	124,4	122,5	139	139	1,1	0,6	116	116	144	146,8	1	0,6	125,7	11	–	
	124,4	122,5	139	139	1,1	0,6	116	116	144	146,8	1	0,6	125,7	11	10	
	124,4	122,5	139	139	1,1	0,6	116	116	144	146,8	1	0,6	125,7	11	10	
122,4	119	137,5	140,9	1,1	0,6	116	113,2	144	146,8	1	0,6	125,4	11	–		
122,4	119	137,5	140,9	1,1	0,6	116	113,2	144	146,8	1	0,6	125,4	11	–		
122,4	119	137,5	140,9	1,1	0,6	116	113,2	144	146,8	1	0,6	125,4	11	8,6		
122,4	119	137,5	140,9	1,1	0,6	116	113,2	144	146,8	1	0,6	125,4	11	8,6		

¹⁾ For calculating the initial grease fill → page 101

2.1 Angular contact ball bearings d 110 – 120 mm

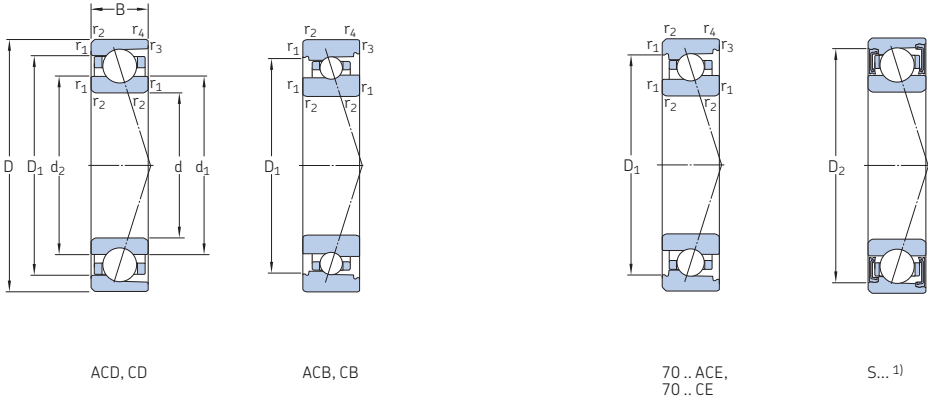

Principal dimensions	Basic load ratings		Fatigue load limit P_u	Attainable speeds		Mass ²⁾	Designation	Available variants			
	dynamic C	static C_0		Grease lubrication	Oil-air lubrication ²⁾			Sealing solution ¹⁾	Direct oil-air lubrication ³⁾		
d	D	B									
mm			kN	kN	r/min	kg	–	–			
110 cont.	150	20	58,5	68	2,55	7 500	12 000	0,86	71922 ACD/P4A	S	H1, L
	150	20	58,5	68	2,55	8 500	14 000	0,73	71922 ACD/HCP4A	S	H1, L
	150	20	62,4	72	2,7	8 000	13 000	0,86	71922 CD/P4A	S	H1, L
	150	20	62,4	72	2,7	10 000	16 000	0,73	71922 CD/HCP4A	S	H1, L
	170	28	35,1	34	1,22	9 000	14 000	2,2	7022 ACB/P4A	S	L
	170	28	35,1	34	1,22	11 000	16 000	2,1	7022 ACB/HCP4A	S	L
	170	28	37,1	36	1,29	10 000	16 000	2,2	7022 CB/P4A	S	L
	170	28	37,1	36	1,29	12 000	19 000	2,1	7022 CB/HCP4A	S	L
	170	28	44,9	42,5	1,53	10 000	15 500	2,1	7022 ACE/P4A	S	H1, L, L1
	170	28	44,9	42,5	1,53	11 500	17 500	1,95	7022 ACE/HCP4A	S	H1, L, L1
	170	28	47,5	45	1,6	10 900	17 000	2,1	7022 CE/P4A	S	H1, L, L1
	170	28	47,5	45	1,6	12 700	20 000	1,95	7022 CE/HCP4A	S	H1, L, L1
170	28	104	104	3,75	7 000	11 000	1,95	7022 ACD/P4A	S	H1, L	
170	28	104	104	3,75	8 500	13 000	1,65	7022 ACD/HCP4A	S	H1, L	
170	28	111	108	3,9	7 500	12 000	1,95	7022 CD/P4A	S	H1, L	
170	28	111	108	3,9	9 500	14 000	1,65	7022 CD/HCP4A	S	H1, L	
200	38	168	160	5,4	6 700	10 000	4,65	7222 ACD/P4A	–	–	
200	38	168	160	5,4	7 500	12 000	3,85	7222 ACD/HCP4A	–	–	
200	38	178	166	5,6	7 000	11 000	4,65	7222 CD/P4A	–	–	
200	38	178	166	5,6	8 500	13 000	3,85	7222 CD/HCP4A	–	–	
120	150	16	31,2	42,5	1,53	6 700	11 000	0,55	71824 ACD/P4	–	–
	150	16	31,2	42,5	1,53	8 000	13 000	0,49	71824 ACD/HCP4	–	–
	150	16	33,2	45	1,63	7 500	12 000	0,55	71824 CD/P4	–	–
	150	16	33,2	45	1,63	9 000	14 000	0,49	71824 CD/HCP4	–	–
	165	22	25,5	28,5	1,02	9 000	14 000	1,25	71924 ACB/P4A	S	L
	165	22	25,5	28,5	1,02	11 000	17 000	1,2	71924 ACB/HCP4A	S	L
	165	22	27	30,5	1,08	10 000	16 000	1,25	71924 CB/P4A	S	L
	165	22	27	30,5	1,08	12 000	20 000	1,2	71924 CB/HCP4A	S	L

1) Designation prefix S. For details, refer to *Sealing solutions* (→ page 136).

2) Applicable to open bearings only.

3) Designation suffix H, H1, L or L1. For details, refer to *Direct oil-air lubrication* (→ page 136).

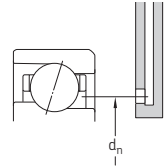
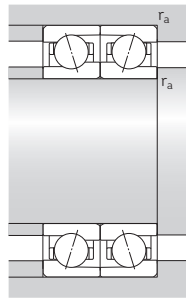
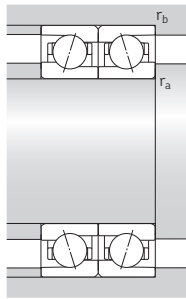
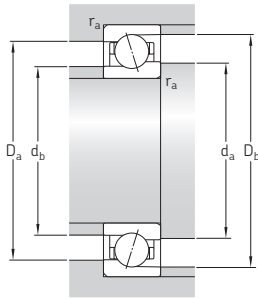

Dimensions					Abutment and fillet dimensions								Reference grease quantity ¹⁾	Calculation factor	
d	d ₁	d ₂	D ₁	D ₂	r _{1,2} min.	r _{3,4} min.	d _a min.	d _b min.	D _a max.	D _b max.	r _a max.	r _b max.	d _n	G _{ref}	f ₀
mm														cm ³	-
110 cont.	122,3	122,3	137,7	140,6	1,1	0,6	116	116	144	146	1	0,6	125,6	11	-
	122,3	122,3	137,7	140,6	1,1	0,6	116	116	144	146	1	0,6	125,6	11	-
	122,3	122,3	137,7	140,6	1,1	0,6	116	116	144	146	1	0,6	125,6	11	16,5
	122,3	122,3	137,7	140,6	1,1	0,6	116	116	144	146	1	0,6	125,6	11	16,5
	133,2	130,5	151,9	151,9	2	1	119	119	161	165,4	2	1	134,6	22	-
	133,2	130,5	151,9	151,9	2	1	119	119	161	165,4	2	1	134,6	22	-
	133,2	130,5	151,9	151,9	2	1	119	119	161	165,4	2	1	134,6	22	9,7
	133,2	130,5	151,9	151,9	2	1	119	119	161	165,4	2	1	134,6	22	9,7
	132,4	129,2	152,2	152,2	2	1	118,8	118,8	161,2	164,4	2	1	135,4	23	-
	132,4	129,2	152,2	152,2	2	1	118,8	118,8	161,2	164,4	2	1	135,4	23	-
	132,4	129,2	152,2	152,2	2	1	118,8	118,8	161,2	164,4	2	1	135,4	23	9,6
	132,4	129,2	152,2	152,2	2	1	118,8	118,8	161,2	164,4	2	1	135,4	23	9,6
128,5	128,5	151,5	155,2	2	1	119	119	161	165	2	1	132,6	26	-	
128,5	128,5	151,5	155,2	2	1	119	119	161	165	2	1	132,6	26	-	
128,5	128,5	151,5	155,2	2	1	119	119	161	165	2	1	132,6	26	15,5	
128,5	128,5	151,5	155,2	2	1	119	119	161	165	2	1	132,6	26	15,5	
138,7	138,7	171,3	-	2,1	1,1	122	122	188	193	2	1	145,9	54	-	
138,7	138,7	171,3	-	2,1	1,1	122	122	188	193	2	1	145,9	54	-	
138,7	138,7	171,3	-	2,1	1,1	122	122	188	193	2	1	145,9	54	14,7	
138,7	138,7	171,3	-	2,1	1,1	122	122	188	193	2	1	145,9	54	14,7	
120	129,8	129,8	140,6	-	1	0,3	124,6	124,6	145,4	148	1	0,3	130,9	5,5	-
	129,8	129,8	140,6	-	1	0,3	124,6	124,6	145,4	148	1	0,3	130,9	5,5	-
	129,8	129,8	140,6	-	1	0,3	124,6	124,6	145,4	148	1	0,3	130,9	5,5	17,3
	129,8	129,8	140,6	-	1	0,3	124,6	124,6	145,4	148	1	0,3	130,9	5,5	17,3
	136,9	135	151,9	151,9	1,1	0,6	126	126	159	161,8	1	0,6	138,2	14	-
	136,9	135	151,9	151,9	1,1	0,6	126	126	159	161,8	1	0,6	138,2	14	-
	136,9	135	151,9	151,9	1,1	0,6	126	126	159	161,8	1	0,6	138,2	14	10
	136,9	135	151,9	151,9	1,1	0,6	126	126	159	161,8	1	0,6	138,2	14	10

¹⁾ For calculating the initial grease fill → page 101

2.1 Angular contact ball bearings d 120 – 130 mm

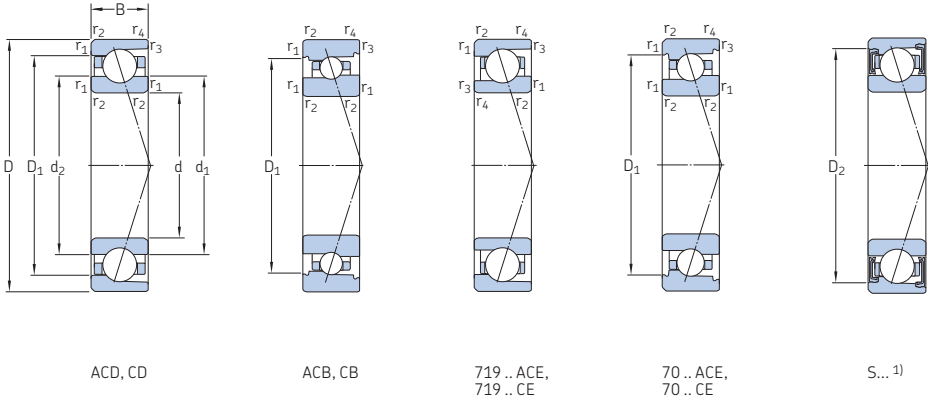

Principal dimensions	Basic load ratings		Fatigue load limit P_u	Attainable speeds		Mass ²⁾	Designation	Available variants			
	dynamic C	static C_0		Grease lubrication	Oil-air lubrication ²⁾			Sealing solution ¹⁾	Direct oil-air lubrication ³⁾		
d D B	kN		kN	r/min		kg	-	-			
mm	kN		kN	r/min		kg	-	-			
120 cont.	165	22	44,9	38	1,32	9 500	15 000	1,1	71924 ACE/P4A	S	H1, L
	165	22	44,9	38	1,32	11 500	17 500	0,93	71924 ACE/HCP4A	S	H1, L
	165	22	47,5	40,5	1,4	11 200	16 000	1,1	71924 CE/P4A	S	H1, L
	165	22	47,5	40,5	1,4	12 700	19 000	0,93	71924 CE/HCP4A	S	H1, L
	165	22	72,8	86,5	3,05	7 000	11 000	1,15	71924 ACD/P4A	S	H1, L
	165	22	72,8	86,5	3,05	8 000	13 000	0,99	71924 ACD/HCP4A	S	H1, L
	165	22	78	91,5	3,25	7 500	12 000	1,15	71924 CD/P4A	S	H1, L
	165	22	78	91,5	3,25	9 000	14 000	0,99	71924 CD/HCP4A	S	H1, L
	180	28	35,8	36,5	1,27	8 500	13 000	2,35	7024 ACB/P4A	S	L
	180	28	35,8	36,5	1,27	10 000	15 000	2,25	7024 ACB/HCP4A	S	L
	180	28	37,7	39	1,34	9 500	14 000	2,35	7024 CB/P4A	S	L
	180	28	37,7	39	1,34	11 000	17 000	2,25	7024 CB/HCP4A	S	L
	180	28	54	52	1,8	8 300	13 000	2,15	7024 ACE/P4A	S	H1, L, L1
	180	28	54	52	1,8	10 000	15 500	1,95	7024 ACE/HCP4A	S	H1, L, L1
	180	28	57,2	55	1,9	9 300	14 500	2,15	7024 CE/P4A	S	H1, L, L1
	180	28	57,2	55	1,9	11 200	17 500	1,95	7024 CE/HCP4A	S	H1, L, L1
	180	28	111	116	4	6 700	10 000	2,15	7024 ACD/P4A	S	H1, L
	180	28	111	116	4	8 000	12 000	1,75	7024 ACD/HCP4A	S	H1, L
	180	28	114	122	4,25	7 000	11 000	2,15	7024 CD/P4A	S	H1, L
	180	28	114	122	4,25	8 500	13 000	1,75	7024 CD/HCP4A	S	H1, L
215	40	190	183	6	6 000	9 000	5,4	7224 ACD/P4A	-	-	
215	40	190	183	6	7 000	11 000	4,4	7224 ACD/HCP4A	-	-	
215	40	199	193	6,3	6 700	10 000	5,4	7224 CD/P4A	-	-	
215	40	199	193	6,3	8 000	12 000	4,4	7224 CD/HCP4A	-	-	
130	165	18	36,4	50	1,76	6 300	9 500	0,77	71826 ACD/P4	-	-
	165	18	36,4	50	1,76	7 500	12 000	0,7	71826 ACD/HCP4	-	-
	165	18	39	53	1,86	7 000	11 000	0,77	71826 CD/P4	-	-
	165	18	39	53	1,86	8 500	13 000	0,7	71826 CD/HCP4	-	-

1) Designation prefix S. For details, refer to *Sealing solutions* (→ page 136).

2) Applicable to open bearings only.

3) Designation suffix H, H1, L or L1. For details, refer to *Direct oil-air lubrication* (→ page 136).

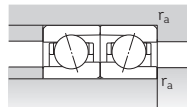
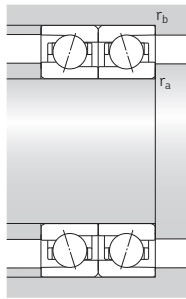
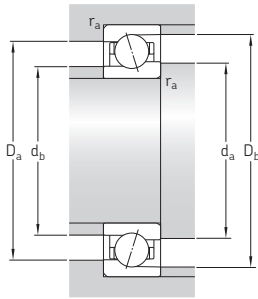

ACD, CD, ACB, CB,
70 .. ACE, 70 .. CE

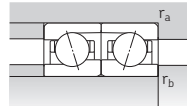

719 .. ACE, 719 .. CE

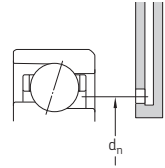

Dimensions					Abutment and fillet dimensions								Reference grease quantity ¹⁾	Calculation factor		
d	d ₁	d ₂	D ₁	D ₂	r _{1,2} min.	r _{3,4} min.	d _a min.	d _b min.	D _a max.	D _b max.	r _a max.	r _b max.	d _n	G _{ref}	f ₀	
mm															cm ³	-
120 cont.	134	130,2	151	154,4	1,1	0,6	126	123,2	159	161,8	1	0,6	137,4	15	-	
	134	130,2	151	154,4	1,1	0,6	126	123,2	159	161,8	1	0,6	137,4	15	-	
	134	130,2	151	154,4	1,1	0,6	126	123,2	159	161,8	1	0,6	137,4	15	8,5	
	134	130,2	151	154,4	1,1	0,6	126	123,2	159	161,8	1	0,6	137,4	15	8,5	
	133,9	133,9	151,1	154,1	1,1	0,6	126	126	159	161	1	0,6	137,6	15	-	
	133,9	133,9	151,1	154,1	1,1	0,6	126	126	159	161	1	0,6	137,6	15	-	
	133,9	133,9	151,1	154,1	1,1	0,6	126	126	159	161	1	0,6	137,6	15	16,5	
	133,9	133,9	151,1	154,1	1,1	0,6	126	126	159	161	1	0,6	137,6	15	16,5	
	143,2	140,8	161,9	161,9	2	1	129	129	171	175,4	2	1	144,7	24	-	
	143,2	140,8	161,9	161,9	2	1	129	129	171	175,4	2	1	144,7	24	-	
	143,2	140,8	161,9	161,9	2	1	129	129	171	175,4	2	1	144,7	24	9,8	
	143,2	140,8	161,9	161,9	2	1	129	129	171	175,4	2	1	144,7	24	9,8	
141,4	137,8	163,2	163,2	2	1	128,8	128,8	171,2	174,4	2	1	144,9	28	-		
141,4	137,8	163,2	163,2	2	1	128,8	128,8	171,2	174,4	2	1	144,9	28	-		
141,4	137,8	163,2	163,2	2	1	128,8	128,8	171,2	174,4	2	1	144,9	28	9,6		
141,4	137,8	163,2	163,2	2	1	128,8	128,8	171,2	174,4	2	1	144,9	28	9,6		
138,5	138,5	161,5	165,1	2	1	129	129	171	175	2	1	142,6	27	-		
138,5	138,5	161,5	165,1	2	1	129	129	171	175	2	1	142,6	27	-		
138,5	138,5	161,5	165,1	2	1	129	129	171	175	2	1	142,6	27	15,7		
138,5	138,5	161,5	165,1	2	1	129	129	171	175	2	1	142,6	27	15,7		
150,3	150,3	186,7	-	2,1	1,1	132	132	203	208	2	1	158,2	69	-		
150,3	150,3	186,7	-	2,1	1,1	132	132	203	208	2	1	158,2	69	-		
150,3	150,3	186,7	-	2,1	1,1	132	132	203	208	2	1	158,2	69	14,6		
150,3	150,3	186,7	-	2,1	1,1	132	132	203	208	2	1	158,2	69	14,6		
130	141,8	141,8	153,2	-	1,1	0,6	136	136	159	161,8	1	0,6	144	9,3	-	
	141,8	141,8	153,2	-	1,1	0,6	136	136	159	161,8	1	0,6	144	9,3	-	
	141,8	141,8	153,2	-	1,1	0,6	136	136	159	161,8	1	0,6	144	9,3	17,3	
	141,8	141,8	153,2	-	1,1	0,6	136	136	159	161,8	1	0,6	144	9,3	17,3	

¹⁾ For calculating the initial grease fill → page 101

2.1 Angular contact ball bearings

d 130 – 140 mm

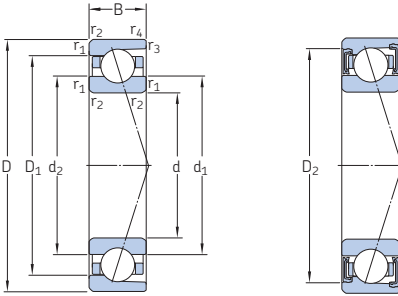

S... 1)

Principal dimensions			Basic load ratings		Fatigue load limit P_u	Attainable speeds		Mass ²⁾	Designation	Available variants	
d	D	B	dynamic C	static C_0		Grease lubrication	Oil-air lubrication ²⁾			Sealing solu- tion ¹⁾	Direct oil-air lubrication ³⁾
mm			kN		kN	r/min		kg	-	-	
130 cont.	180	24	87,1	102	3,45	6 700	10 000	1,55	71926 ACD/P4A	S	H1, L
	180	24	87,1	102	3,45	7 500	12 000	1,3	71926 ACD/HCP4A	S	H1, L
	180	24	92,3	108	3,65	7 000	11 000	1,55	71926 CD/P4A	S	H1, L
	180	24	92,3	108	3,65	8 500	13 000	1,3	71926 CD/HCP4A	S	H1, L
	200	33	140	150	4,9	6 000	9 000	3,25	7026 ACD/P4A	S	H1, L
	200	33	140	150	4,9	7 500	12 000	2,65	7026 ACD/HCP4A	S	H1, L
	200	33	148	156	5,2	7 000	10 000	3,25	7026 CD/P4A	S	H1, L
	200	33	148	156	5,2	8 000	13 000	2,65	7026 CD/HCP4A	S	H1, L
	230	40	203	212	6,7	5 600	8 500	6,35	7226 ACD/P4A	-	-
	230	40	203	212	6,7	6 700	10 000	5,2	7226 ACD/HCP4A	-	-
	230	40	216	224	6,95	6 300	9 500	6,35	7226 CD/P4A	-	-
	230	40	216	224	6,95	7 500	11 000	5,2	7226 CD/HCP4A	-	-
140	175	18	42,3	58,5	2	6 000	9 000	0,8	71828 ACD/P4	-	-
	175	18	42,3	58,5	2	7 000	11 000	0,71	71828 ACD/HCP4	-	-
	175	18	44,9	62	2,12	6 300	10 000	0,8	71828 CD/P4	-	-
	175	18	44,9	62	2,12	8 000	12 000	0,71	71828 CD/HCP4	-	-
	190	24	90,4	110	3,65	6 000	9 000	1,65	71928 ACD/P4A	S	H1, L
	190	24	90,4	110	3,65	7 000	11 000	1,4	71928 ACD/HCP4A	S	H1, L
	190	24	95,6	116	3,9	6 700	10 000	1,65	71928 CD/P4A	S	H1, L
	190	24	95,6	116	3,9	8 000	12 000	1,4	71928 CD/HCP4A	S	H1, L
	210	33	146	156	5,1	5 600	8 500	3,4	7028 ACD/P4A	S	H1, L
	210	33	146	156	5,1	7 000	11 000	2,85	7028 ACD/HCP4A	S	H1, L
	210	33	153	166	5,3	6 700	10 000	3,4	7028 CD/P4A	S	H1, L
	210	33	153	166	5,3	7 500	12 000	2,85	7028 CD/HCP4A	S	H1, L
	250	42	212	228	6,95	5 000	7 500	8,15	7228 ACD/P4A	-	-
	250	42	212	228	6,95	6 000	9 000	6,9	7228 ACD/HCP4A	-	-
	250	42	221	240	7,35	5 600	8 500	8,15	7228 CD/P4A	-	-
	250	42	221	240	7,35	7 000	10 000	6,9	7228 CD/HCP4A	-	-

1) Designation prefix S. For details, refer to *Sealing solutions* (→ page 136).

2) Applicable to open bearings only.

3) Designation suffix H, H1, L or L1. For details, refer to *Direct oil-air lubrication* (→ page 136).

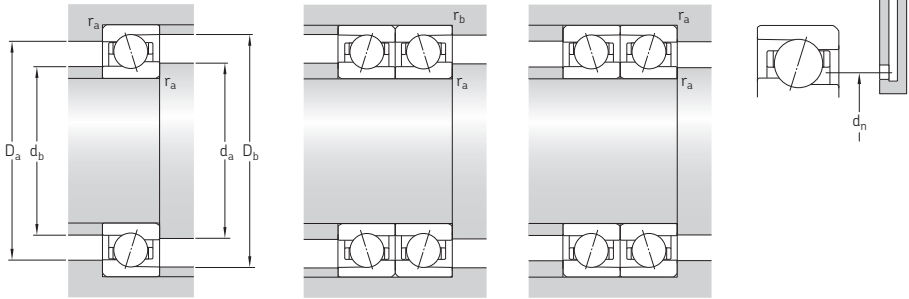

Dimensions					Abutment and fillet dimensions								Reference grease quantity ¹⁾	Calculation factor	
d	d ₁	d ₂	D ₁	D ₂	r _{1,2} min.	r _{3,4} min.	d _a min.	d _b min.	D _a max.	D _b max.	r _a max.	r _b max.	d _n	G _{ref}	f ₀
mm														cm ³	–
130 cont.	145,4	145,4	164,6	168,3	1,5	0,6	137	137	173	176	1,5	0,6	149,5	20	–
	145,4	145,4	164,6	168,3	1,5	0,6	137	137	173	176	1,5	0,6	149,5	20	–
	145,4	145,4	164,6	168,3	1,5	0,6	137	137	173	176	1,5	0,6	149,5	20	16,4
	145,4	145,4	164,6	168,3	1,5	0,6	137	137	173	176	1,5	0,6	149,5	20	16,4
	151,6	151,6	178,4	183,1	2	1	139	139	191	195	2	1	156,4	42	–
	151,6	151,6	178,4	183,1	2	1	139	139	191	195	2	1	156,4	42	–
	151,6	151,6	178,4	183,1	2	1	139	139	191	195	2	1	156,4	42	15,6
	151,6	151,6	178,4	183,1	2	1	139	139	191	195	2	1	156,4	42	15,6
	162,8	162,8	199,2	–	3	1,1	144	144	216	223	2,5	1	170,7	72	–
	162,8	162,8	199,2	–	3	1,1	144	144	216	223	2,5	1	170,7	72	–
	162,8	162,8	199,2	–	3	1,1	144	144	216	223	2,5	1	170,7	72	14,9
	162,8	162,8	199,2	–	3	1,1	144	144	216	223	2,5	1	170,7	72	14,9
140	151,3	151,3	163,7	–	1,1	0,6	146	146	169	171,8	1	0,6	153,2	9,9	–
	151,3	151,3	163,7	–	1,1	0,6	146	146	169	171,8	1	0,6	153,2	9,9	–
	151,3	151,3	163,7	–	1,1	0,6	146	146	169	171,8	1	0,6	153,2	9,9	17,3
	151,3	151,3	163,7	–	1,1	0,6	146	146	169	171,8	1	0,6	153,2	9,9	17,3
	155,4	155,4	174,6	178,3	1,5	0,6	147	147	183	186	1,5	0,6	159,5	22	–
	155,4	155,4	174,6	178,3	1,5	0,6	147	147	183	186	1,5	0,6	159,5	22	–
	155,4	155,4	174,6	178,3	1,5	0,6	147	147	183	186	1,5	0,6	159,5	22	16,6
	155,4	155,4	174,6	178,3	1,5	0,6	147	147	183	186	1,5	0,6	159,5	22	16,6
	161,6	161,6	188,4	193,1	2	1	149	149	201	205	2	1	166,3	45	–
	161,6	161,6	188,4	193,1	2	1	149	149	201	205	2	1	166,3	45	–
	161,6	161,6	188,4	193,1	2	1	149	149	201	205	2	1	166,3	45	15,8
	161,6	161,6	188,4	193,1	2	1	149	149	201	205	2	1	166,3	45	15,8
	176,9	176,9	213,2	–	3	1,5	154	154	236	241	2,5	1,5	184,8	84	–
	176,9	176,9	213,2	–	3	1,5	154	154	236	241	2,5	1,5	184,8	84	–
	176,9	176,9	213,2	–	3	1,5	154	154	236	241	2,5	1,5	184,8	84	15,2
	176,9	176,9	213,2	–	3	1,5	154	154	236	241	2,5	1,5	184,8	84	15,2

¹⁾ For calculating the initial grease fill → page 101

2.1 Angular contact ball bearings d 150 – 170 mm

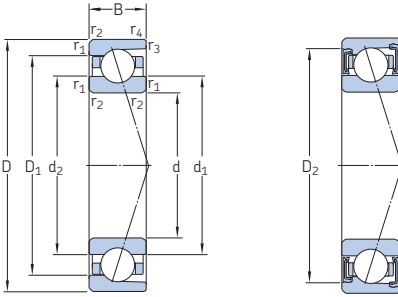

S...¹⁾

Principal dimensions			Basic load ratings		Fatigue load limit P_u	Attainable speeds		Mass ²⁾	Designation	Available variants	
d	D	B	dynamic C	static C_0		Grease lubrication	Oil-air lubrication ²⁾			Sealing solution ¹⁾	Direct oil-air lubrication ³⁾
mm			kN		kN	r/min		kg	-	-	
150	190	20	48,8	68	2,2	5 300	8 500	1,1	71830 ACD/P4	-	-
	190	20	48,8	68	2,2	6 300	10 000	0,98	71830 ACD/HCP4	-	-
	190	20	52	72	2,36	6 000	9 000	1,1	71830 CD/P4	-	-
	190	20	52	72	2,36	7 000	11 000	0,98	71830 CD/HCP4	-	-
	210	28	119	140	4,5	5 600	8 500	2,55	71930 ACD/P4A	S	H1, L
	210	28	119	140	4,5	6 700	10 000	2,05	71930 ACD/HCP4A	S	H1, L
	210	28	125	146	4,75	6 300	9 500	2,55	71930 CD/P4A	S	H1, L
	210	28	125	146	4,75	7 500	11 000	2,05	71930 CD/HCP4A	S	H1, L
	225	35	163	180	5,6	5 300	8 000	4,15	7030 ACD/P4A	S	H1, L
	225	35	163	180	5,6	6 700	10 000	3,45	7030 ACD/HCP4A	S	H1, L
	225	35	172	190	5,85	6 000	9 000	4,15	7030 CD/P4A	S	H1, L
	225	35	172	190	5,85	7 000	11 000	3,45	7030 CD/HCP4A	S	H1, L
160	200	20	50,7	75	2,36	5 000	8 000	1,25	71832 ACD/P4	-	-
	200	20	50,7	75	2,36	6 000	9 500	1,1	71832 ACD/HCP4	-	-
	200	20	54	78	2,5	5 600	8 500	1,25	71832 CD/P4	-	-
	200	20	54	78	2,5	6 700	10 000	1,1	71832 CD/HCP4	-	-
	220	28	124	153	4,75	5 300	8 000	2,7	71932 ACD/P4A	-	H1, L
	220	28	124	153	4,75	6 300	9 500	2,25	71932 ACD/HCP4A	-	H1, L
	220	28	130	160	5	6 000	9 000	2,7	71932 CD/P4A	-	H1, L
	220	28	130	160	5	7 500	11 000	2,25	71932 CD/HCP4A	-	H1, L
	240	38	182	204	6,2	5 000	7 500	5,15	7032 ACD/P4A	-	H1, L
	240	38	182	204	6,2	6 300	9 500	4,25	7032 ACD/HCP4A	-	H1, L
	240	38	195	216	6,55	5 600	8 500	5,15	7032 CD/P4A	-	H1, L
	240	38	195	216	6,55	6 700	11 000	4,25	7032 CD/HCP4A	-	H1, L
170	230	28	124	160	4,8	5 000	7 500	2,85	71934 ACD/P4A	-	H1
	230	28	124	160	4,8	6 000	9 000	2,35	71934 ACD/HCP4A	-	H1
	230	28	133	166	5,1	5 600	8 500	2,85	71934 CD/P4A	-	H1
	230	28	133	166	5,1	7 000	10 000	2,35	71934 CD/HCP4A	-	H1

¹⁾ Designation prefix S. For details, refer to *Sealing solutions* (→ page 136).

²⁾ Applicable to open bearings only.

³⁾ Designation suffix H, H1, L or L1. For details, refer to *Direct oil-air lubrication* (→ page 136).

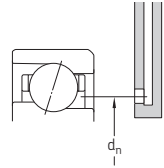
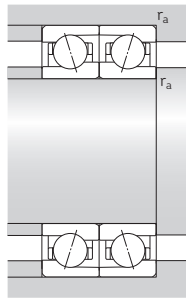
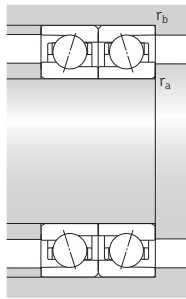
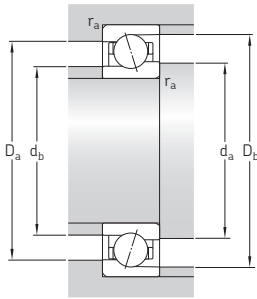

Dimensions					Abutment and fillet dimensions								Reference grease quantity ¹⁾	Calculation factor	
d	d ₁	d ₂	D ₁	D ₂	r _{1,2} min.	r _{3,4} min.	d _a min.	d _b min.	D _a max.	D _b max.	r _a max.	r _b max.	d _n	G _{ref}	f ₀
mm														cm ³	–
150	163,4	163,4	176,7	–	1,1	0,6	156	156	184	186,8	1	0,6	165,6	13	–
	163,4	163,4	176,7	–	1,1	0,6	156	156	184	186,8	1	0,6	165,6	13	–
	163,4	163,4	176,7	–	1,1	0,6	156	156	184	186,8	1	0,6	165,6	13	17,3
	163,4	163,4	176,7	–	1,1	0,6	156	156	184	186,8	1	0,6	165,6	13	17,3
	168,5	168,5	191,5	195,2	2	1	159	159	201	205	2	1	173,5	33	–
	168,5	168,5	191,5	195,2	2	1	159	159	201	205	2	1	173,5	33	–
	168,5	168,5	191,5	195,2	2	1	159	159	201	205	2	1	173,5	33	16,2
	168,5	168,5	191,5	195,2	2	1	159	159	201	205	2	1	173,5	33	16,2
	173,1	173,1	201,9	206,6	2,1	1	161	161	214	220	2	1	178,2	54	–
	173,1	173,1	201,9	206,6	2,1	1	161	161	214	220	2	1	178,2	54	–
	173,1	173,1	201,9	206,6	2,1	1	161	161	214	220	2	1	178,2	54	15,8
	173,1	173,1	201,9	206,6	2,1	1	161	161	214	220	2	1	178,2	54	15,8
160	173,4	173,4	186,7	–	1,1	0,6	166	166	194	196,8	1	0,6	175,6	14	–
	173,4	173,4	186,7	–	1,1	0,6	166	166	194	196,8	1	0,6	175,6	14	–
	173,4	173,4	186,7	–	1,1	0,6	166	166	194	196,8	1	0,6	175,6	14	17,4
	173,4	173,4	186,7	–	1,1	0,6	166	166	194	196,8	1	0,6	175,6	14	17,4
	178,5	178,5	201,5	–	2	1	169	169	211	215	2	1	183,5	33	–
	178,5	178,5	201,5	–	2	1	169	169	211	215	2	1	183,5	33	–
	178,5	178,5	201,5	–	2	1	169	169	211	215	2	1	183,5	33	16,4
	178,5	178,5	201,5	–	2	1	169	169	211	215	2	1	183,5	33	16,4
	184,7	184,7	215,3	–	2,1	1	171	171	229	235	2	1	191,4	66	–
	184,7	184,7	215,3	–	2,1	1	171	171	229	235	2	1	191,4	66	–
	184,7	184,7	215,3	–	2,1	1	171	171	229	235	2	1	191,4	66	15,8
	184,7	184,7	215,3	–	2,1	1	171	171	229	235	2	1	191,4	66	15,8
170	188,5	188,5	211,5	–	2	1	179	179	221	225	2	1	193,5	36	–
	188,5	188,5	211,5	–	2	1	179	179	221	225	2	1	193,5	36	–
	188,5	188,5	211,5	–	2	1	179	179	221	225	2	1	193,5	36	16,5
	188,5	188,5	211,5	–	2	1	179	179	221	225	2	1	193,5	36	16,5

¹⁾ For calculating the initial grease fill → page 101

2.1 Angular contact ball bearings

d 170 – 200 mm

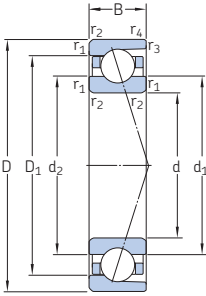

Principal dimensions	Basic load ratings		Fatigue load limit P_u	Attainable speeds		Mass	Designation	Available variants			
	dynamic C	static C_0		Grease lubrication	Oil-air lubrication			Sealing	Direct oil-air solution lubrication ¹⁾		
d D B	kN		kN	r/min		kg	–	–			
mm							–	–			
170 cont.	260	42	199	232	6,7	4 800	7 000	7	7034 ACD/P4A	–	H1, L
	260	42	199	232	6,7	6 000	9 000	5,95	7034 ACD/HCP4A	–	H1, L
	260	42	212	245	7,1	5 300	8 000	7	7034 CD/P4A	–	H1, L
	260	42	212	245	7,1	6 300	10 000	5,95	7034 CD/HCP4A	–	H1, L
180	250	33	159	200	5,85	4 800	7 000	4,2	71936 ACD/P4A	–	H1
	250	33	159	200	5,85	5 600	8 500	3,5	71936 ACD/HCP4A	–	H1
	250	33	168	212	6,1	5 300	8 000	4,2	71936 CD/P4A	–	H1
	250	33	168	212	6,1	6 700	9 500	3,5	71936 CD/HCP4A	–	H1
	280	46	229	275	7,65	4 300	6 300	9,1	7036 ACD/P4A	–	H1, L
	280	46	229	275	7,65	5 300	8 000	7,7	7036 ACD/HCP4A	–	H1, L
	280	46	242	290	8,15	5 000	7 500	9,1	7036 CD/P4A	–	H1, L
	280	46	242	290	8,15	6 000	9 000	7,7	7036 CD/HCP4A	–	H1, L
190	260	33	163	208	5,85	4 500	6 700	4,35	71938 ACD/P4A	–	H1
	260	33	163	208	5,85	5 300	8 000	3,65	71938 ACD/HCP4A	–	H1
	260	33	172	220	6,2	5 000	7 500	4,35	71938 CD/P4A	–	H1
	260	33	172	220	6,2	6 300	9 000	3,65	71938 CD/HCP4A	–	H1
	290	46	234	290	8	4 300	6 300	9,5	7038 ACD/P4A	–	H1
	290	46	234	290	8	5 300	8 000	8,05	7038 ACD/HCP4A	–	H1
	290	46	247	305	8,3	4 800	7 000	9,5	7038 CD/P4A	–	H1
	290	46	247	305	8,3	5 600	9 000	8,05	7038 CD/HCP4A	–	H1
200	280	38	199	250	6,8	4 300	6 300	6,1	71940 ACD/P4A	–	H1
	280	38	199	250	6,8	5 000	7 500	5,1	71940 ACD/HCP4A	–	H1
	280	38	208	265	7,2	4 800	7 000	6,1	71940 CD/P4A	–	H1
	280	38	208	265	7,2	6 000	8 500	5,1	71940 CD/HCP4A	–	H1
	310	51	281	365	9,8	4 000	6 000	12,5	7040 ACD/P4A	–	H1
	310	51	281	365	9,8	5 000	7 500	10	7040 ACD/HCP4A	–	H1
	310	51	296	390	10,2	4 500	6 700	12,5	7040 CD/P4A	–	H1
	310	51	296	390	10,2	5 300	8 000	10	7040 CD/HCP4A	–	H1

¹⁾ Designation suffix H, H1, L or L1. For details, refer to *Direct oil-air lubrication* (→ page 136).

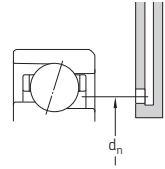
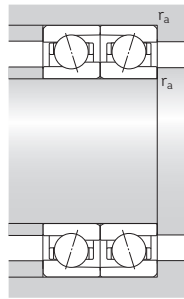
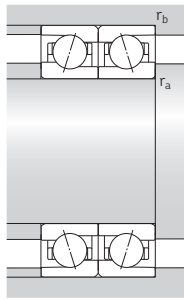
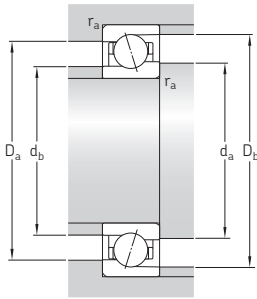

Dimensions					Abutment and fillet dimensions								Reference grease quantity ¹⁾	Calculation factor		
d	d ₁	d ₂	D ₁	D ₂	r _{1,2} min.	r _{3,4} min.	d _a min.	d _b min.	D _a max.	D _b max.	r _a max.	r _b max.	d _n	G _{ref}	f ₀	
mm															cm ³	–
170 cont.	198,7	198,7	231,3	–	2,1	1,1	181	181	249	254	2	1	205,8	84	–	
	198,7	198,7	231,3	–	2,1	1,1	181	181	249	254	2	1	205,8	84	–	
	198,7	198,7	231,3	–	2,1	1,1	181	181	249	254	2	1	205,8	84	15,9	
	198,7	198,7	231,3	–	2,1	1,1	181	181	249	254	2	1	205,8	84	15,9	
180	201,6	201,6	228,4	–	2	1	189	189	241	245	2	1	207,4	54	–	
	201,6	201,6	228,4	–	2	1	189	189	241	245	2	1	207,4	54	–	
	201,6	201,6	228,4	–	2	1	189	189	241	245	2	1	207,4	54	16,3	
	201,6	201,6	228,4	–	2	1	189	189	241	245	2	1	207,4	54	16,3	
	211,8	211,8	248,2	–	2,1	1,1	191	191	269	274	2	1	219,7	111	–	
	211,8	211,8	248,2	–	2,1	1,1	191	191	269	274	2	1	219,7	111	–	
	211,8	211,8	248,2	–	2,1	1,1	191	191	269	274	2	1	219,7	111	15,7	
	211,8	211,8	248,2	–	2,1	1,1	191	191	269	274	2	1	219,7	111	15,7	
190	211,6	211,6	238,4	–	2	1	199	199	251	255	2	1	217,4	57	–	
	211,6	211,6	238,4	–	2	1	199	199	251	255	2	1	217,4	57	–	
	211,6	211,6	238,4	–	2	1	199	199	251	255	2	1	217,4	57	16,4	
	211,6	211,6	238,4	–	2	1	199	199	251	255	2	1	217,4	57	16,4	
	221,8	221,8	258,2	–	2,1	1,1	201	201	279	284	2	1	229,7	114	–	
	221,8	221,8	258,2	–	2,1	1,1	201	201	279	284	2	1	229,7	114	–	
	221,8	221,8	258,2	–	2,1	1,1	201	201	279	284	2	1	229,7	114	15,9	
	221,8	221,8	258,2	–	2,1	1,1	201	201	279	284	2	1	229,7	114	15,9	
200	224,7	224,7	255,3	–	2,1	1	209	209	271	275	2	1	231,4	81	–	
	224,7	224,7	255,3	–	2,1	1	209	209	271	275	2	1	231,4	81	–	
	224,7	224,7	255,3	–	2,1	1	209	209	271	275	2	1	231,4	81	16,3	
	224,7	224,7	255,3	–	2,1	1	209	209	271	275	2	1	231,4	81	16,3	
	233,9	233,9	276,1	–	2,1	1,1	211	211	299	304	2	1	243,2	153	–	
	233,9	233,9	276,1	–	2,1	1,1	211	211	299	304	2	1	243,2	153	–	
	233,9	233,9	276,1	–	2,1	1,1	211	211	299	304	2	1	243,2	153	15,6	
	233,9	233,9	276,1	–	2,1	1,1	211	211	299	304	2	1	243,2	153	15,6	

¹⁾ For calculating the initial grease fill → page 101

2.1 Angular contact ball bearings

d 220 – 300 mm

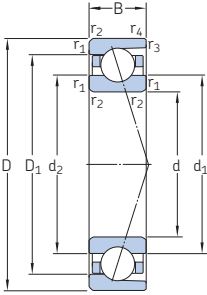

Principal dimensions			Basic load ratings		Fatigue load limit P_u	Attainable speeds		Mass	Designation	Available variants		
d	D	B	dynamic C	static C_0		Grease lubrication	Oil-air lubrication			Sealing	Direct oil-air solution lubrication ¹⁾	
mm			kN		kN	r/min		kg	–	–		
220	300	38	208	285	7,5	3 800	5 600	6,6	71944 ACD/P4A	–	L	
	300	38	208	285	7,5	4 500	6 700	5,55	71944 ACD/HCP4A	–	L	
	300	38	221	300	7,8	4 300	6 300	6,6	71944 CD/P4A	–	L	
	300	38	221	300	7,8	5 300	7 500	5,55	71944 CD/HCP4A	–	L	
	340	56	319	440	11	3 600	5 300	16	7044 ACD/P4A	–	–	
	340	56	319	440	11	4 500	6 700	13	7044 ACD/HCP4A	–	–	
	340	56	338	455	11,6	4 000	6 000	16	7044 CD/P4A	–	–	
	340	56	338	455	11,6	4 800	7 500	13	7044 CD/HCP4A	–	–	
	240	320	38	216	305	7,8	3 200	4 800	8,5	71948 ACD/P4A	–	L
		320	38	216	305	7,8	3 800	5 600	6	71948 ACD/HCP4A	–	L
		320	38	229	325	8,15	3 800	5 600	8,5	71948 CD/P4A	–	L
		320	38	229	325	8,15	4 800	6 700	6	71948 CD/HCP4A	–	L
360		56	325	465	11,4	3 400	5 000	17	7048 ACD/P4A	–	–	
360		56	325	465	11,4	4 300	6 300	14	7048 ACD/HCP4A	–	–	
360		56	345	490	12	3 800	5 600	17	7048 CD/P4A	–	–	
360		56	345	490	12	4 500	7 000	14	7048 CD/HCP4A	–	–	
260		360	46	265	400	9,65	2 800	4 300	12	71952 ACD/P4A	–	L
		360	46	265	400	9,65	3 600	5 300	10,5	71952 ACD/HCP4A	–	L
		360	46	281	425	10,2	3 400	5 000	12	71952 CD/P4A	–	L
		360	46	281	425	10,2	4 300	6 000	10,5	71952 CD/HCP4A	–	L
	400	65	397	600	14	3 000	4 500	25,5	7052 ACD/P4A	–	–	
	400	65	416	630	14,6	3 400	5 300	25,5	7052 CD/P4A	–	–	
	280	380	46	276	430	10	2 600	4 000	13	71956 ACD/P4A	–	–
		380	46	276	430	10	3 200	4 800	11	71956 ACD/HCP4A	–	–
		380	46	291	455	10,6	3 200	4 800	13	71956 CD/P4A	–	–
		380	46	291	455	10,6	4 000	5 600	11	71956 CD/HCP4A	–	–
	300	420	56	351	560	12,7	2 200	3 400	23	71960 ACDMA/P4A	–	–
		420	56	351	560	12,7	2 600	4 000	19,5	71960 ACDMA/HCP4A	–	–
420		56	371	600	13,4	3 000	4 500	23	71960 CDMA/P4A	–	–	
420		56	371	600	13,4	3 800	5 300	19,5	71960 CDMA/HCP4A	–	–	

¹⁾ Designation suffix H, H1, L or L1. For details, refer to *Direct oil-air lubrication* (→ page 136).

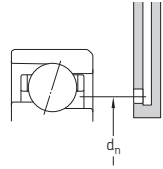
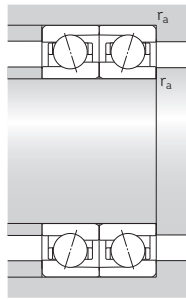
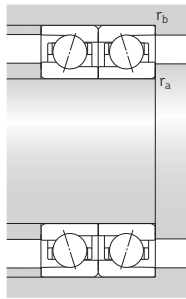
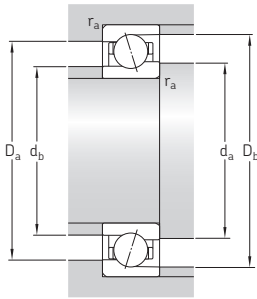

Dimensions					Abutment and fillet dimensions								Reference grease quantity ¹⁾	Calculation factor		
d	d ₁	d ₂	D ₁	D ₂	r _{1,2} min.	r _{3,4} min.	d _a min.	d _b min.	D _a max.	D _b max.	r _a max.	r _b max.	d _n	G _{ref}	f ₀	
mm															cm ³	–
220	244,7	244,7	275,3	–	2,1	1	231	231	289	295	2	1	251,4	84	–	
	244,7	244,7	275,3	–	2,1	1	231	231	289	295	2	1	251,4	84	–	
	244,7	244,7	275,3	–	2,1	1	231	231	289	295	2	1	251,4	84	16,5	
	244,7	244,7	275,3	–	2,1	1	231	231	289	295	2	1	251,4	84	16,5	
	257	257	303	–	3	1,5	233	233	327	334	2,5	1,5	267,1	201	–	
	257	257	303	–	3	1,5	233	233	327	334	2,5	1,5	267,1	201	–	
	257	257	303	–	3	1,5	233	233	327	334	2,5	1,5	267,1	201	15,6	
	257	257	303	–	3	1,5	233	233	327	334	2,5	1,5	267,1	201	15,6	
	240	264,7	264,7	295,3	–	2,1	1	251	251	309	315	2	1	271,4	93	–
		264,7	264,7	295,3	–	2,1	1	251	251	309	315	2	1	271,4	93	–
		264,7	264,7	295,3	–	2,1	1	251	251	309	315	2	1	271,4	93	16,7
		264,7	264,7	295,3	–	2,1	1	251	251	309	315	2	1	271,4	93	16,7
277		277	323	–	3	1,5	253	253	347	354	2,5	1,5	287	216	–	
277		277	323	–	3	1,5	253	253	347	354	2,5	1,5	287	216	–	
277		277	323	–	3	1,5	253	253	347	354	2,5	1,5	287	216	15,8	
277		277	323	–	3	1,5	253	253	347	354	2,5	1,5	287	216	15,8	
260		291,8	291,8	328,2	–	2,1	1,1	271	271	349	354	2	1	299,7	150	–
		291,8	291,8	328,2	–	2,1	1,1	271	271	349	354	2	1	299,7	150	–
		291,8	291,8	328,2	–	2,1	1,1	271	271	349	354	2	1	299,7	150	16,5
		291,8	291,8	328,2	–	2,1	1,1	271	271	349	354	2	1	299,7	150	16,5
	303,2	303,2	356,8	–	4	1,5	275	275	385	393	3	1,5	315	324	–	
	303,2	303,2	356,8	–	4	1,5	275	275	385	393	3	1,5	315	324	15,7	
	280	311,8	311,8	348,2	–	2,1	1,1	291	291	369	374	2	1	319,7	159	–
		311,8	311,8	348,2	–	2,1	1,1	291	291	369	374	2	1	319,7	159	–
		311,8	311,8	348,2	–	2,1	1,1	291	291	369	374	2	1	319,7	159	16,7
		311,8	311,8	348,2	–	2,1	1,1	291	291	369	374	2	1	319,7	159	16,7
		300	337	337	383	–	3	1,1	313	313	405	414	2,5	1	347	265
	337		337	383	–	3	1,1	313	313	405	414	2,5	1	347	265	–
337	337		383	–	3	1,1	313	313	405	414	2,5	1	347	265	16,3	
337	337		383	–	3	1,1	313	313	405	414	2,5	1	347	265	16,3	
337	337		383	–	3	1,1	313	313	405	414	2,5	1	347	265	16,3	

¹⁾ For calculating the initial grease fill → page 101

2.1 Angular contact ball bearings

d 320 – 360 mm

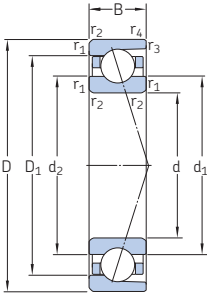

Principal dimensions			Basic load ratings		Fatigue load limit P_u	Attainable speeds		Mass	Designation	Available variants	
d	D	B	dynamic C	static C_0		Grease lubrication	Oil-air lubrication			Sealing	Direct oil-air solution
mm			kN		kN	r/min		kg	–	–	
320	440	56	351	585	12,9	2 200	3 400	24	71964 ACDMA/P4A	–	–
	440	56	351	585	12,9	2 600	4 000	20,5	71964 ACDMA/HCP4A	–	–
	440	56	377	620	13,7	2 600	4 300	24	71964 CDMA/P4A	–	–
	440	56	377	620	13,7	3 600	5 000	20,5	71964 CDMA/HCP4A	–	–
340	460	56	364	640	13,4	2 000	3 200	25,5	71968 ACDMA/P4A	–	–
	460	56	364	640	13,4	2 400	3 800	21,5	71968 ACDMA/HCP4A	–	–
	460	56	390	670	14,3	2 400	4 000	25,5	71968 CDMA/P4A	–	–
	460	56	390	670	14,3	3 400	4 800	21,5	71968 CDMA/HCP4A	–	–
360	480	56	371	670	13,7	1 900	3 000	26,5	71972 ACDMA/P4A	–	–
	480	56	371	670	13,7	2 200	3 600	22,5	71972 ACDMA/HCP4A	–	–
	480	56	397	710	14,6	2 400	4 000	26,5	71972 CDMA/P4A	–	–
	480	56	397	710	14,6	3 400	4 800	22,5	71972 CDMA/HCP4A	–	–

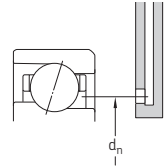
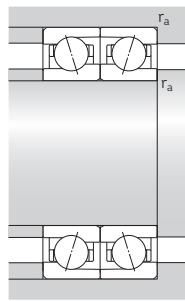
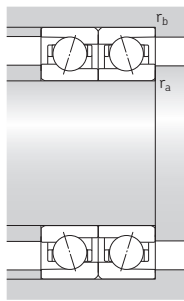
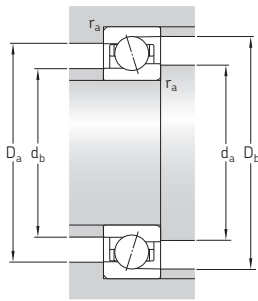

Dimensions					Abutment and fillet dimensions								Reference grease quantity ¹⁾	Calculation factor	
d	d ₁	d ₂	D ₁	D ₂	r _{1,2} min.	r _{3,4} min.	d _a min.	d _b min.	D _a max.	D _b max.	r _a max.	r _b max.	d _n	G _{ref}	f ₀
mm														cm ³	–
320	357	357	403	–	3	1,1	333	333	425	434	2,5	1	367	282	–
	357	357	403	–	3	1,1	333	333	425	434	2,5	1	367	282	–
	357	357	403	–	3	1,1	333	333	425	434	2,5	1	367	282	16,5
	357	357	403	–	3	1,1	333	333	425	434	2,5	1	367	282	16,5
340	377	377	423	–	3	1,1	353	353	445	454	2,5	1	387	294	–
	377	377	423	–	3	1,1	353	353	445	454	2,5	1	387	294	–
	377	377	423	–	3	1,1	353	353	445	454	2,5	1	387	294	16,6
	377	377	423	–	3	1,1	353	353	445	454	2,5	1	387	294	16,6
360	397	397	443	–	3	1,1	373	373	465	474	2,5	1	407	313	–
	397	397	443	–	3	1,1	373	373	465	474	2,5	1	407	313	–
	397	397	443	–	3	1,1	373	373	465	474	2,5	1	407	313	16,7
	397	397	443	–	3	1,1	373	373	465	474	2,5	1	407	313	16,7

¹⁾ For calculating the initial grease fill → page 101



Super-precision bearing

SKF

Cylindrical roller bearings

Designs and variants	264	Product tables	
Single row cylindrical roller bearings . . .	264	3.1 Single row cylindrical roller bearings	288
Basic design bearings	264	3.2 Double row cylindrical roller bearings	294
High-speed design bearings	264		
Double row cylindrical roller bearings . .	265		
Annular groove and lubrication holes .	266		
Bearings with a pre-ground raceway .	267		
Cages	267		
Hybrid bearings	268		
Bearing data	269		
(Boundary dimensions, tolerances, axial displacement)			
Radial internal clearance	273		
Radial internal clearance or preload in mounted bearings	275		
Radial stiffness	275		
Equivalent bearing loads	277		
Attainable speeds	277		
Design considerations	278		
Adjusting for clearance or preload	278		
Free space on both sides of the bearing .	280		
Mounting	280		
Mounting a bearing in the NN 30 K series using a GB 30 series gauge	282		
Mounting bearings with a tapered bore by measuring radial clearance prior to mounting	284		
Mounting and dismounting, using the oil injection method	285		
Designation system	286		

More information

Bearing life and load ratings	33
Requisite minimum load	34
Chamfer dimension limits	47
Materials	51
Design considerations	57
Lubrication	99
Mounting and dismounting	123
Bearing storage	125
Gauges	391

Designs and variants

SKF manufactures super-precision single row and double row cylindrical roller bearings in three different designs and series. The bearings, which can accommodate axial displacement of the shaft relative to the housing in both directions, are separable, i.e. the bearing ring with the roller and cage assembly can be separated from the other ring. This simplifies mounting and dismounting, particularly when load conditions require both rings to have an interference fit.

SKF super-precision cylindrical roller bearings are characterized by:

- high speed capability
- high radial load carrying capacity
- high rigidity
- low friction
- low cross-sectional height

These bearings are therefore particularly well suited for machine tool spindles where the bearing arrangement must accommodate heavy radial loads and high speeds, while providing a high degree of stiffness.

SKF super-precision single row cylindrical roller bearings have a higher speed capability than double row bearings while double row bearings are more suitable for heavier loads.

Single row cylindrical roller bearings

SKF super-precision single row cylindrical roller bearings in the N 10 series (→ **fig. 1**) have, as standard, a 1:12 tapered bore (designation suffix K). A tapered bore is preferred because the taper enables accurate adjustment of clearance or preload during mounting. The bearings have two integral flanges on the inner ring and no flanges on the outer ring. To improve lubricant flow, these bearings can be supplied with a lubrication hole in the outer ring on request.

Basic design bearings

Basic design single row cylindrical roller bearings are equipped as standard with a roller centred PA66 cage without glass fibre reinforcement for bore diameters up to 80 mm (designation suffix TN), and with glass fibre reinforcement for larger sizes (designation suffix TN9). These bearings are well suited for most precision applications.

High-speed design bearings

The internal geometry and cages of high-speed design single row cylindrical roller bearings have been optimized to accommodate higher speeds. High-speed design bearings contain fewer rollers than basic design bearings. They are equipped with either an asymmetrical cage, made of glass fibre reinforced PEEK (designation suffix TNHA), or a symmetrical cage, made of carbon fibre reinforced PEEK (designation suffix PHA). Both are outer ring centred cages, designed to optimize the effectiveness of the lubricant and avoid kinematic lubricant starvation at high speeds. When comparing the two cages, the symmetrical PHA cage provides better guidance and promotes better lubrication conditions for superior performance.

Compared to bearings with a glass fibre reinforced PEEK cage, bearings with a carbon fibre reinforced PEEK cage can accommodate speeds up to 30% higher in grease lubricated applications and up to 15% higher when lubricated with an oil-air system.

For applications like the non-tool end of a motorized spindle, where the requirement for higher speed outweighs that for higher rigidity, bearings containing cages with half the number of rollers can be supplied on request.

Fig. 1

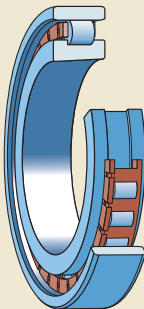

Double row cylindrical roller bearings

SKF super-precision double row cylindrical roller bearings (→ **fig. 2**) are manufactured as standard in the NN 30 and NNU 49 series.

Both series are available with either a cylindrical or a 1:12 tapered bore (designation suffix K). In machine tool applications, cylindrical roller bearings with a tapered bore are preferred over bearings with a cylindrical bore, because the taper enables more accurate adjustment of clearance or preload during mounting.

NN 30 series

Bearings in the NN 30 series can provide a unique balance between load carrying capacity, rigidity and speed. They are therefore typically used as the non-tool end bearing in machine tool spindles.

NN 30 series bearings have three integral flanges on the inner ring and no flanges on the outer ring.

NNU 49 series

Bearings in the NNU 49 series, with a very low cross-sectional height, provide a higher degree of stiffness than bearings in the NN 30 series, but a somewhat lower load carrying capacity.

NNU 49 series bearings have three integral flanges on the outer ring and no flanges on the inner ring.

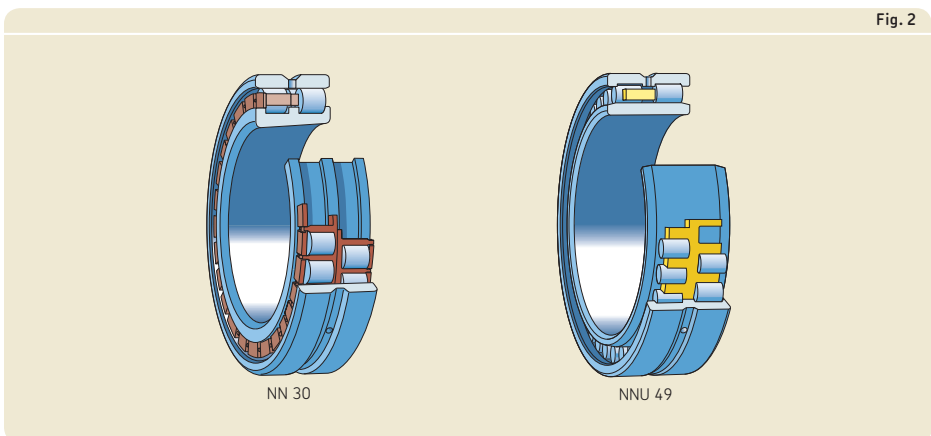

Annular groove and lubrication holes

To facilitate efficient lubrication, all bearings in the NNU 49 series and bearings in the NN 30 series with a bore diameter $d \geq 140$ mm, have an annular groove and three lubrication holes in the outer ring (→ **fig. 3**, designation suffix W33).

Bearings without an annular groove and lubrication holes are typically lubricated either with the requisite minimum quantity of grease or with accurately metered, small quantities of oil or oil-air. In this case, the lubricant is delivered through a nozzle, positioned to the side of the bearing (→ **fig. 4** and **product tables**, **page 294**).

If NN 30 series bearings with a bore diameter $d \leq 130$ mm (→ **table 1**) require an annular groove and lubrication holes, check SKF for availability early in the design phase.

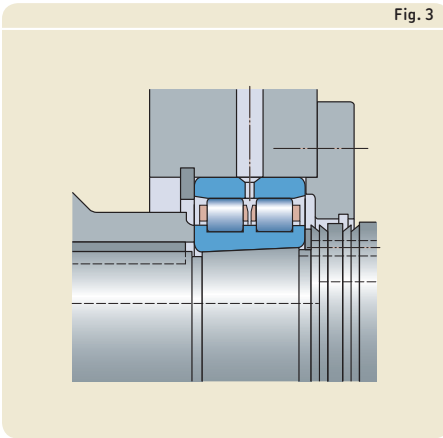

Fig. 3

Table 1

Annular groove and lubrication hole dimensions for NN 30 .. W33 series bearings ($d \leq 130$ mm)

The diagram shows a cross-section of a bearing with an annular groove. Dimension 'b' is the width of the groove, and dimension 'K' is the diameter of the lubrication holes.

Bore diameter d	Dimensions	
	b	K
mm	mm	
50	3,7	2
55	3,7	2
60	3,7	2
65	3,7	2
70	5,5	3
75	5,5	3
80	5,5	3
85	5,5	3
90	5,5	3
95	5,5	3
100	5,5	3
105	5,5	3
110	5,5	3
120	5,5	3
130	8,3	4,5

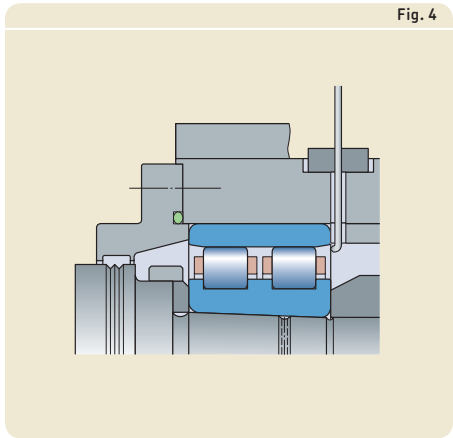

Fig. 4

Bearings with a pre-ground raceway

When there is a demand for an exceptionally high degree of running accuracy, SKF recommends mounting the flangeless inner ring of an NNU 49 series bearing onto the shaft and then finish-grinding the inner ring raceway and other shaft diameters in one operation.

For these applications, SKF can supply NNU 49 series bearings with a tapered bore and a finish-grinding allowance on the inner ring raceway (designation suffix VU001). The finish-grinding allowance, which depends on the bore diameter of the inner ring, is listed in **table 2**.

Cages

SKF super-precision single row cylindrical roller bearings can be fitted with one of the following cages:

- a PA66 cage, window-type, roller centred, designation suffix TN
- a glass fibre reinforced PA66 cage, window-type, roller centred, designation suffix TN9
- a glass fibre reinforced PEEK cage, window-type, outer ring centred, designation suffix TNHA
- a carbon fibre reinforced PEEK cage, window-type, outer ring centred, designation suffix PHA

Depending on their design, series and size, SKF super-precision double row cylindrical roller bearings are fitted as standard with the following cages:

- two PA66 cages, window-type, roller centred, designation suffix TN
- two glass fibre reinforced PA66 cages, window-type, roller centred, designation suffix TN9
- one or two machined brass cages, prong-type, roller centred, no designation suffix

For information about the suitability of cages, refer to *Cage materials* (→ **page 55**).

Table 2

Finish-grinding allowance on the inner ring raceway of NNU 49.. K/VU001 bearings

Bore diameter d		Grinding allowance
over	incl.	
mm		mm
–	110	0,2
110	360	0,3
360	–	0,4

Hybrid bearings

Hybrid cylindrical roller bearings (designation suffix HC5) are available in the N 10 series and can be supplied on request in the NN 30 series. They have rings made of bearing steel and rollers made of bearing grade silicon nitride (ceramic). As ceramic rollers are lighter and have a higher modulus of elasticity and lower coefficient of thermal expansion than steel rollers, hybrid bearings can provide the following advantages:

- higher degree of rigidity
- higher speed capability
- reduced centrifugal and inertial forces within the bearing
- minimized stress at the outer ring rolling contacts at high speeds
- reduced frictional heat
- less energy consumption
- extended bearing and grease service life
- less prone to skid smearing damage and cage damage when subjected to frequent rapid starts and stops
- less sensitive to temperature differences within the bearing
- more accurate preload control

For additional information about silicon nitride, refer to *Materials for bearing rings and rolling elements* (→ **page 51**).

In order to maximize the performance of a hybrid bearing, SKF recommends using hybrid single row bearings with an outer ring centred window-type PEEK cage (designation suffix PHA or TNHA). These bearings, depending on the cage design, can attain speeds up to $A = 2\,200\,000$ mm/min, when under light load and lubricated with an oil-air system, (→ **diagram 5, page 40**). They can attain speeds up to $A = 1\,800\,000$ mm/min, when grease lubricated (→ **diagram 6, page 42**). As an option to further improve lubricant flow, bearings in the N 10 series with a lubrication hole in the outer ring can be supplied on request.

Bearing data

Boundary dimensions	ISO 15
Tolerances For additional information (→ page 47)	<ul style="list-style-type: none"> • SP class tolerances (→ table 3, page 270) as standard • higher precision UP class tolerances (→ table 4, page 271) on request • SP and UP class tolerances for 1:12 tapered bore (→ table 5, page 272)
Axial displacement	Accommodate axial displacement of the shaft relative to the housing within certain limits (→ product tables). During operation, axial displacement occurs within the bearing and not between the bearing and shaft or housing bore. As a result, there is virtually no increase in friction.

Table 3

SP class tolerances

Inner ring d		$\Delta_{ds}, \Delta_{dmp}^{1)2)}$		V_{dp} max.	Δ_{Bs}		V_{Bs} max.	K_{ia} max.	S_d max.
over	incl.	high	low		high	low			
mm		μm		μm	μm		μm	μm	μm
-	18	0	-5	3	0	-100	5	3	8
18	30	0	-6	3	0	-100	5	3	8
30	50	0	-8	4	0	-120	5	4	8
50	80	0	-9	5	0	-150	6	4	8
80	120	0	-10	5	0	-200	7	5	9
120	180	0	-13	7	0	-250	8	6	10
180	250	0	-15	8	0	-300	10	8	11
250	315	0	-18	9	0	-350	13	10	13
315	400	0	-23	12	0	-400	15	12	15
400	500	0	-28	14	0	-450	25	12	18
500	630	0	-35	18	0	-500	30	15	20
630	800	0	-45	23	0	-750	35	15	23
Outer ring D		$\Delta_{Ds}, \Delta_{Dmp}^{2)}$		V_{Dp} max.	Δ_{Cs}, V_{Cs}		K_{ea} max.	S_D max.	
over	incl.	high	low						
mm		μm		μm			μm	μm	
30	50	0	-7	4	Values are identical to those for the inner ring of the same bearing.		5	8	
50	80	0	-9	5			5	8	
80	120	0	-10	5			6	9	
120	150	0	-11	6			7	10	
150	180	0	-13	7			8	10	
180	250	0	-15	8			10	11	
250	315	0	-18	9			11	13	
315	400	0	-20	10			13	13	
400	500	0	-23	12			15	15	
500	630	0	-28	14			17	18	
630	800	0	-35	18			20	20	
800	1000	0	-50	25			25	30	

Tolerance symbols and definitions → table 4, page 48

1) SP tolerances for 1:12 tapered bore → table 5, page 272

2) Tolerances Δ_{ds} and Δ_{Ds} apply to NNU design bearings with an outside diameter $D \leq 630$ mm. Tolerances Δ_{dmp} and Δ_{Dmp} apply to larger NNU design bearings and to N and NN design bearings.

Table 4

UP class tolerances

Inner ring d		$\Delta_{ds}^{1)}$		V_{dp}	Δ_{Bs}		V_{Bs}	K_{ia}	S_d
over	incl.	high	low	max.	high	low	max.	max.	max.
mm		μm		μm	μm		μm	μm	μm
–	18	0	–4	2	0	–70	1,5	1,5	2
18	30	0	–5	2,5	0	–80	1,5	1,5	3
30	50	0	–6	3	0	–100	2	2	3
50	80	0	–7	3,5	0	–100	3	2	4
80	120	0	–8	4	0	–100	3	3	4
120	180	0	–10	5	0	–100	4	3	5
180	250	0	–12	6	0	–150	5	4	6
250	315	0	–15	8	0	–150	5	4	6
315	400	0	–19	10	0	–150	6	5	7
400	500	0	–23	12	0	–200	7	5	8
500	630	0	–26	13	0	–200	8	6	9
630	800	0	–34	17	0	–200	10	7	11
Outer ring D		Δ_{Ds}		V_{Dp}	Δ_{Cs}, V_{Cs}		K_{ea}	S_D	
over	incl.	high	low	max.			max.	max.	
mm		μm		μm			μm	μm	
30	50	0	–5	3	Values are identical to those for the inner ring of the same bearing.		3	2	
50	80	0	–6	3			3	2	
80	120	0	–7	4			3	3	
120	150	0	–8	4			4	3	
150	180	0	–9	5			4	3	
180	250	0	–10	5			5	4	
250	315	0	–12	6			6	4	
315	400	0	–14	7			7	5	
400	500	0	–17	9			8	5	
500	630	0	–20	10			9	6	
630	800	0	–25	13			11	7	
800	1 000	0	–30	15			12	10	

Tolerance symbols and definitions → table 4, page 48

¹⁾ UP tolerances for 1:12 tapered bore → table 5, page 272

SP and UP class tolerances for 1:12 tapered bore

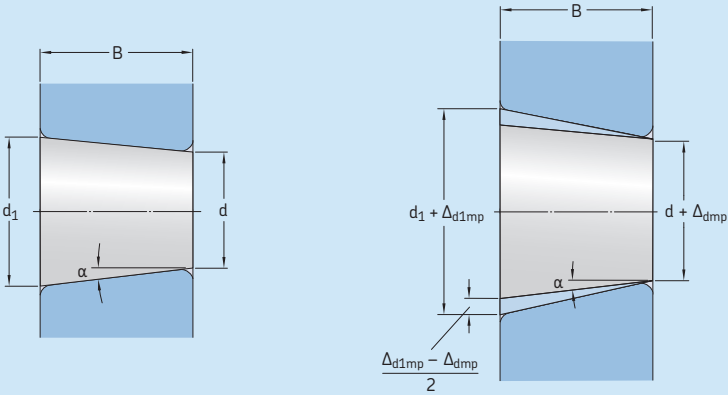

Half angle of taper 1:12

$$\alpha = 2^\circ 23' 9,4''$$

Largest theoretical diameter d_1

$$d_1 = d + \frac{1}{12} B$$

Bore diameter		SP class tolerances				UP class tolerances					
d over	incl.	Δ_{dmp} high	low	$V_{dp}^{(1)}$ max.	Δ_{d1mp} high	$-\Delta_{dmp}$ low	Δ_{dmp} high	low	$V_{dp}^{(1)}$ max.	Δ_{d1mp} high	$-\Delta_{dmp}$ low
mm		μm		μm	μm		μm		μm	μm	
18	30	+10	0	3	+4	0	+6	0	2,5	+2	0
30	50	+12	0	4	+4	0	+7	0	3	+3	0
50	80	+15	0	5	+5	0	+8	0	3,5	+3	0
80	120	+20	0	5	+6	0	+10	0	4	+4	0
120	180	+25	0	7	+8	0	+12	0	5	+4	0
180	250	+30	0	8	+10	0	+14	0	6	+5	0
250	315	+35	0	9	+12	0	+15	0	8	+6	0
315	400	+40	0	12	+12	0	+17	0	10	+6	0
400	500	+45	0	14	+14	0	+19	0	12	+7	0
500	630	+50	0	18	+15	0	+20	0	13	+11	0
630	800	+65	0	23	+19	0	+22	0	17	+13	0

Tolerance symbols and definitions → table 4, page 48

¹⁾ Applies to any single radial plane of the bore.

Radial internal clearance

SKF super-precision cylindrical roller bearings manufactured to the SP tolerance class are supplied with C1 radial internal clearance (no designation suffix) as standard.

On request, bearings in the N 10 and NN 30 series can also be supplied with a special reduced radial clearance (smaller than C1), when a minimum operating clearance or a preload after mounting is required. For information about clearance values and availability, contact the SKF application engineering service.

Bearings made to the SP tolerance class, particularly those in the NNU 49 series, are also available with a radial internal clearance greater than C1. When ordering, the requisite clearance should be indicated in the designation by the suffix:

- SPC2 for clearance greater than C1
- CN for Normal clearance, greater than SPC2
- C3 for clearance greater than Normal

The values for radial internal clearance are listed in **table 6 (→ page 274)**. They are in accordance with ISO 5753-1 (except for SPC2) and are valid for new, unmounted bearings under zero measuring load. SPC2 radial clearance values deviate from those standardized for C2. The clearance range is reduced and displaced toward the lower limit.

To achieve the required radial internal clearance, the rings of individual bearings are matched at the factory, marked with the same identification number and usually packaged together in a single box. Be sure to check that the numbers on both rings match prior to mounting. Any mismatch could have a negative impact on the radial internal clearance and the performance characteristics of the final assembly.

Radial internal clearance of super-precision cylindrical roller bearings

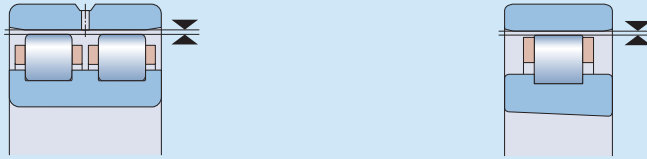

Bore diameter		Radial internal clearance Bearings with a cylindrical bore								Bearings with a tapered bore			
d over	incl.	C1		SPC2		Normal		C3		C1		SPC2	
		min.	max.	min.	max.	min.	max.	min.	max.	min.	max.	min.	max.
mm		µm											
24	30	5	15	10	25	20	45	35	60	15	25	25	35
30	40	5	15	12	25	25	50	45	70	15	25	25	40
40	50	5	18	15	30	30	60	50	80	17	30	30	45
50	65	5	20	15	35	40	70	60	90	20	35	35	50
65	80	10	25	20	40	40	75	65	100	25	40	40	60
80	100	10	30	25	45	50	85	75	110	35	55	45	70
100	120	10	30	25	50	50	90	85	125	40	60	50	80
120	140	10	35	30	60	60	105	100	145	45	70	60	90
140	160	10	35	35	65	70	120	115	165	50	75	65	100
160	180	10	40	35	75	75	125	120	170	55	85	75	110
180	200	15	45	40	80	90	145	140	195	60	90	80	120
200	225	15	50	45	90	105	165	160	220	60	95	90	135
225	250	15	50	50	100	110	175	170	235	65	100	100	150
250	280	20	55	55	110	125	195	190	260	75	110	110	165
280	315	20	60	60	120	130	205	200	275	80	120	120	180
315	355	20	65	65	135	145	225	225	305	90	135	135	200
355	400	25	75	75	150	190	280	280	370	100	150	150	225
400	450	25	85	85	170	210	310	310	410	110	170	170	255
450	500	25	95	95	190	220	330	330	440	120	190	190	285
500	560	25	105	105	210	240	360	360	480	130	210	210	315
560	630	25	115	115	230	260	380	380	500	140	230	230	345
630	710	30	130	130	260	260	380	380	500	160	260	260	390
710	800	35	145	145	290	290	425	425	565	180	290	290	435

Radial internal clearance or preload in mounted bearings

To optimize running accuracy and stiffness, super-precision cylindrical roller bearings should have a minimum radial internal clearance or preload after mounting. Cylindrical roller bearings with a tapered bore are generally mounted with preload.

The required operating clearance or preload depends on the speed, load, lubricant and required stiffness of the complete spindle / bearing system. The geometrical accuracy of the bearing seats also play a key role in being able to obtain the necessary clearance or preload. The operating temperature and temperature distribution within the bearing should also be taken into consideration, since a reduction in operating clearance or an increase in preload may result.

Radial stiffness

Radial stiffness depends on the elastic deformation (deflection) of the bearing under load and can be expressed as a ratio of load to deflection. However, since the relationship between deflection and load is not linear, only guideline values can be provided (→ **table 7, page 276**). These values apply to moderately preloaded, mounted bearings under static conditions, subjected to moderate loads.

More accurate values for radial stiffness can be calculated using advanced computer programs. For additional information, contact the SKF application engineering service and refer to *Bearing stiffness* (→ **page 68**).

Table 7

Static radial stiffness

Bore diameter d	Static radial stiffness N 10						NN 30 ¹⁾ with steel rollers	NNU 49 ¹⁾ with steel rollers
	with steel rollers TN(9) cage			with ceramic rollers TN(9) cage				
mm	N/μm	TNHA cage	PHA cage	TN(9) cage	TNHA cage	PHA cage	N/μm	N/μm
25	–	–	–	–	–	–	640	–
30	–	–	–	–	–	–	690	–
35	–	–	–	–	–	–	820	–
40	450	430	390	610	580	510	890	–
45	480	460	410	620	590	530	940	–
50	530	510	460	690	660	590	1 040	–
55	620	590	540	810	770	700	1 220	–
60	680	650	590	890	850	770	1 330	–
65	740	710	650	970	930	840	1 450	–
70	810	780	720	1 090	1 050	950	1 610	–
75	820	790	720	1 090	1 050	960	1 610	–
80	920	880	810	1 190	1 140	1 040	1 820	–
85	990	950	–	1 280	1 230	–	1 970	–
90	980	940	–	1 320	1 270	–	2 010	–
95	1 060	1 020	–	1 430	1 380	–	2 190	–
100	1 140	1 100	–	1 540	1 490	–	2 350	2 950
105	1 140	1 100	–	1 540	1 490	–	2 330	3 040
110	1 210	1 160	–	1 600	1 540	–	2 470	3 130
120	1 310	1 260	–	1 730	1 670	–	2 760	3 140
130	–	–	–	–	–	–	2 900	3 570
140	–	–	–	–	–	–	3 070	3 670
150	–	–	–	–	–	–	3 310	4 160
160	–	–	–	–	–	–	3 540	4 310
170	–	–	–	–	–	–	3 790	4 460
180	–	–	–	–	–	–	3 970	5 190
190	–	–	–	–	–	–	4 280	5 380
200	–	–	–	–	–	–	4 380	5 480
220	–	–	–	–	–	–	4 700	5 990
240	–	–	–	–	–	–	5 180	6 340
260	–	–	–	–	–	–	5 570	6 830
280	–	–	–	–	–	–	6 010	7 260

¹⁾ For bearings in the NN 30 and NNU 49 series with d > 280 mm, contact the SKF application engineering service.

Equivalent bearing loads

The equivalent dynamic bearing load can be calculated using

$$P = F_r$$

The equivalent static bearing load can be calculated using

$$P_0 = F_r$$

where

P = equivalent dynamic bearing load [kN]

P_0 = equivalent static bearing load [kN]

F_r = radial load [kN]

Attainable speeds

The attainable speeds listed in the product tables are guideline values based on cylindrical roller bearings with a near zero radial internal clearance (→ *Attainable speeds*, page 44).

In applications where operating radial internal clearance > 0,002 mm or preload is applied or where seats and abutments do not meet accuracy requirements, the speed ratings must be reduced (→ *Recommended shaft and housing fits* and *Accuracy of seats and abutments*, pages 70 and 75).

The attainable speeds for preloaded bearings in the N 10 and NN 30 series can be estimated using the guideline values listed in **table 8**. For attainable speeds of preloaded bearings in the NNU 49 series, contact the SKF application engineering service.

Table 8

Attainable speed factor for preloaded bearings in the N 10 and NN 30 series

Preload		Speed factor
min.	max.	$A = n d_m$
μm		mm/min
0	2	≤ 1 300 000
1	3	≤ 1 000 000
2	5	≤ 500 000

n = rotational speed [r/min]
 d_m = bearing mean diameter [mm]
 $= 0,5 (d + D)$

Design considerations

Adjusting for clearance or preload

When mounting a cylindrical roller bearing with a tapered bore, radial internal clearance or preload is determined by how far the bearing inner ring is driven up on its tapered seat. The further up the seat the ring is driven, the more it expands and the less radial internal clearance there will be, until eventually, there is a radial preload in the bearing. To quickly and accurately obtain the specified clearance or preload when mounting a bearing, SKF recommends using gauges (→ **page 391**). Gauges are particularly useful when mounting two or three bearings as it is not necessary to measure and calculate the axial drive-up distance for each bearing (→ *Mounting*, **page 280**).

If obtaining an exact radial internal clearance or preload is not critical or SKF gauges are not available, it is possible to determine the required axial drive-up distance. To do this, locate the assembled bearing at a reference point on the shaft and measure the radial internal clearance with a dial indicator positioned on the outside surface of the outer ring (→ *Mounting bearings with a tapered bore by measuring radial clearance prior to mounting*, **page 284**).

With the radial internal clearance measured using either of the above methods, the axial drive-up distance can be obtained using

$$B_a = \frac{e c}{1\,000}$$

If the bearing is to be mounted against a distance ring (→ **fig. 5**), the width of the distance ring must be adjusted to obtain the value B_a .

If there is no fixed abutment and a threaded nut is used to drive the inner ring assembly up on its tapered seat, the angle through which the nut should be turned can be calculated using

$$\alpha = \frac{360 e c}{1\,000 p}$$

where

B_a = axial drive-up [mm]

α = requisite nut tightening angle [°]

c = measured radial internal clearance at the reference point

- plus the required preload [μm] for preload
- minus the required clearance [μm] for clearance
- minus the adjustment [μm] for an interference fit in the housing bore when not using SKF gauges (→ *Mounting bearings with a tapered bore by measuring radial clearance prior to mounting*)

e = a factor depending on the diameter ratio of the hollow shaft and the bearing series (→ **fig. 6** and **table 9**)

p = thread lead of the nut [mm]

For mounting procedures for super-precision cylindrical roller bearings, refer to *Mounting* (→ **page 280**).

Fig. 5

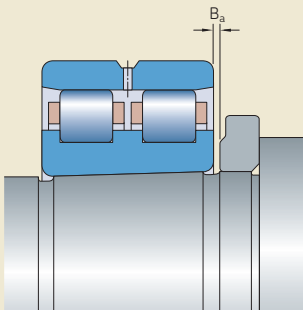

Calculation example

Determine the axial drive-up for a double row cylindrical roller bearing mounted on a hollow shaft. Input data:

- bearing NN 3040 K/SPW33
- measured residual radial internal clearance = 10 μm
- requisite preload = 2 μm
- mean bearing seat diameter $d_{om} = 203 \text{ mm}$
- internal diameter of the hollow shaft $d_i = 140 \text{ mm}$

From **table 9** $e = 18$ for $d_i/d_{om} = 140/203 = 0,69$

With $c = 10 + 2 = 12 \text{ }\mu\text{m}$

$$B_a = \frac{18 \times 12}{1\,000} = 0,216 \text{ mm}$$

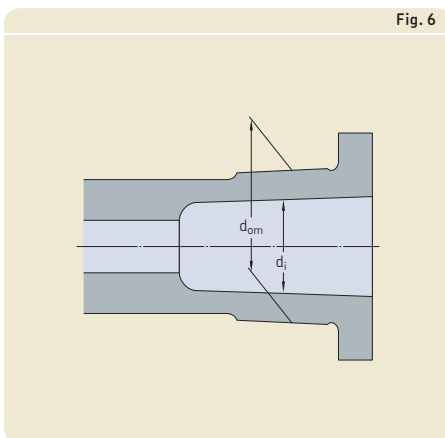

Table 9

Factor e

Hollow shaft diameter ratio
 d_i/d_{om}
over incl.

Factor e for bearings in the series

N 10 K, NN 30 K NNU 49 K

–	0,2	12,5	12
0,2	0,3	14,5	13
0,3	0,4	15	14
0,4	0,5	16	15
0,5	0,6	17	18
0,6	0,7	18	17

Free space on both sides of the bearing

To be sure that N 10 and NN 30 series bearings, with a polymer cage (designation suffix TN, TN9, TNHA or PHA), can accommodate axial displacement of the shaft relative to the housing, free space must be provided on both sides of the bearing (→ **fig. 7**). This prevents damage that might otherwise occur if the cage makes contact with an adjacent component. The minimum width of this free space should be

$$C_a = 1,3 s$$

where

C_a = minimum width of free space [mm]

s = permissible axial displacement from the normal position of one bearing ring relative to the other [mm] (→ **product tables**)

Mounting

To achieve the required radial internal clearance, the rings of individual bearings are matched at the factory, marked with the same identification number and usually packaged together in a single box. Be sure to check that the numbers on both rings match prior to mounting. Any mismatch could have a negative impact on the radial internal clearance and the performance characteristics of the final assembly.

When mounting super-precision cylindrical roller bearings with a tapered bore, the radial internal clearance or preload must be adjusted accurately. This is done by driving the inner ring up on its tapered shaft seat (→ **fig. 8**). The resulting expansion of the inner ring determines the internal clearance or preload in the mounted bearing. For proper mounting, the inside or outside envelope diameter of the roller set must be accurately measured. SKF internal clearance gauges in the GB 30 and GB 10 (→ **fig. 9**) or GB 49 (→ **fig. 10**) series enable simple and accurate measurements. For additional information about internal clearance gauges, refer to *Gauges* (→ **page 391**).

Mounting a cylindrical roller bearing in the NN 30 K series using a GB 30 series gauge is described in the following. The same procedure can be applied when mounting cylindrical roller bearings in the N 10 K series using either a GB 10 or GB 30 series gauge. A similar procedure can be applied when mounting cylin-

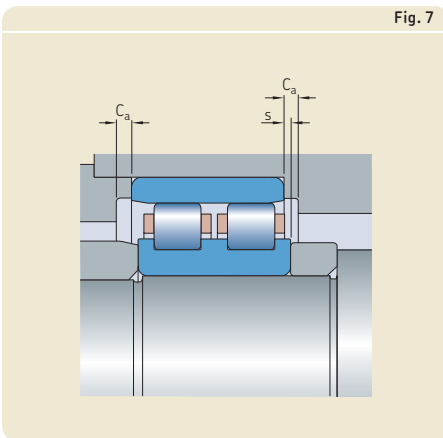

Fig. 7

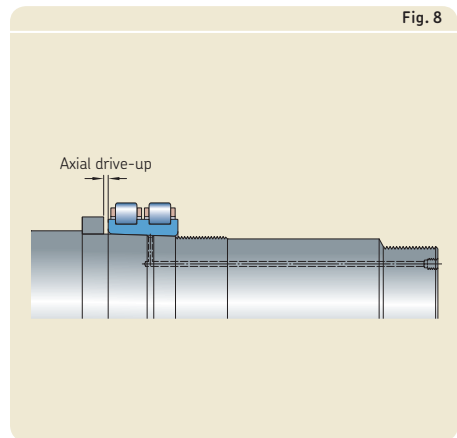

Fig. 8

Fig. 9



GB 3006 ... GB 3020
GB 1010 ... GB 1020



GB 3021 ... GB 3068

3

Fig. 10



GB 4920 ... GB 4938



GB 4940 ... GB 4960

dricular roller bearings in the NNU 49 K series using a GB 49 series gauge.

When mounting without the assistance of an internal clearance gauge, be sure that the accuracy of the readings is sufficient for the application requirements.

Mounting a bearing in the NN 30 K series using a GB 30 series gauge

To mount a bearing in the NN 30 K series, SKF recommends using a GB 30 gauge (→ page 400), a bore gauge and the appropriate hydraulic tools to drive the bearing up onto its seat. Provisions for oil injection are useful for dismounting (→ *Provisions for mounting and dismounting*, page 88). The typical mounting procedure comprises the following steps:

- 1 Mounting the outer ring
 - Heat the housing to the appropriate temperature and slide the outer ring in position.
 - 2 Preparing the gauge
 - Let the housing and the outer ring cool to ambient temperature. Set a bore gauge to the raceway diameter and zero the indicator (→ fig. 11).
 - Place the gauge in the centre of the gauging zone of the GB 30 gauge (→ fig. 12). Adjust the GB 30 gauge, using the adjustment screw until the bore gauge indicates zero minus the correction value listed in the GB 30 user instructions.
 - Increase the inside diameter of the GB 30 gauge by the value of the desired preload or reduce the inside diameter by the value of the desired clearance, using the adjustment screw. Then set the GB 30 gauge indicator to zero. Keep this indicator setting unchanged during the mounting process.
 - 3 Mounting the inner ring (trial)
 - Coat the tapered shaft seat with a thin layer of light oil and push the inner ring, roller and cage assembly until the bearing bore makes good contact with its seat.
 - Expand the GB 30 gauge with the adjustment screw, place it over the roller set and release the adjustment screw so that the gauge makes contact with the roller set (→ fig. 13).
 - 4 Mounting the inner ring (final)
 - Drive the inner ring roller and cage assembly together with the gauge further up on its seat until the indicator on the gauge reads zero. The inner ring is now in the correct position for the desired preload or clearance.
 - Expand the gauge using the adjustment screw and remove it from the roller and cage assembly.
- 4 Mounting the inner ring (final)
 - Measure the distance between the bearing side face and the shaft abutment using gauge blocks (→ fig. 14). Take measurements at different diametrical positions to check accuracy and misalignment. The difference between the single measurements should not exceed 3 to 4 µm.
 - Grind a pre-machined spacer ring to the measured width.
 - Remove the inner ring, mount the spacer ring, and drive up the inner ring again, until it firmly abuts the spacer ring.
 - Place the GB 30 gauge over the roller set as described earlier. Release the adjustment screw. If the indicator reads zero again, the inner ring is properly mounted. Remove the gauge and locate the inner ring, using a suitable locking device.

Fig. 11



Fig. 12



Fig. 13



Fig. 14

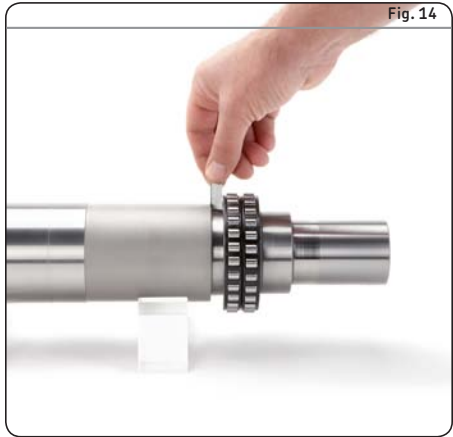

3

Mounting bearings with a tapered bore by measuring radial clearance prior to mounting

If obtaining an exact radial internal clearance or preload is not critical or if SKF gauges are not available, it is possible to determine the required axial drive-up distance. To do this, locate the assembled bearing at a reference point on the shaft and measure the radial internal clearance with a dial indicator positioned on the outside surface of the outer ring. This method does not take into account that the outer ring is compressed when mounted with an interference fit in the housing. To compensate for this, it can be assumed that the outer ring raceway diameter will decrease by 80% of the diametric interference fit. The procedure comprises the following steps:

- 1 Mounting the inner ring (trial)
 - Coat the tapered shaft seat with a thin layer of light oil and push the assembled bearing in place until the bearing bore makes good contact with its seat.
 - There should still be clearance between the outer ring and rollers.
 - Keep in mind that small bearings may have only 15 µm internal clearance prior to mounting and that an axial drive-up of 0,1 mm causes a clearance reduction of ~ 8 µm.

- 2 Measuring the internal clearance prior to mounting
 - Place a spacer ring onto the shaft and position it between the bearing inner ring side face and drive-up device. The spacer, which must be parallel to the bearing inner ring side face, is there to guide the outer ring side face when measuring clearance (→ fig. 15).
 - To measure the radial clearance, place a dial indicator on the outer ring circumference and set the indicator to zero.
 - Holding the outer ring firmly against the spacer, move the outer ring up or down, and measure the total displacement. This measured distance is the radial clearance in the bearing, prior to mounting.
 - Do not apply excessive force to the outer ring. Elastic deformation may cause measurement errors.
- 3 Determine the required axial drive-up distance B_a (→ *Adjusting for clearance or preload*, page 278) remembering to include the allowance for outer ring interference fit, if one exists.
- 4 Determining the spacer ring width
 - Measure the distance L between the bearing side face and the shaft abutment (→ fig. 15). Take measurements at different diametrical positions to check accuracy and misalignment. The difference between the single measurements should not exceed 3 to 4 µm.
 - Calculate the required width of the spacer ring using

$$B = L - B_a$$

where

- B = required width of the spacer ring
- L = mean measured distance from the bearing inner ring to the abutment
- B_a = the required axial drive-up distance to achieve the desired clearance reduction or preload (→ *Adjusting for clearance or preload*, page 278)

Fig. 15

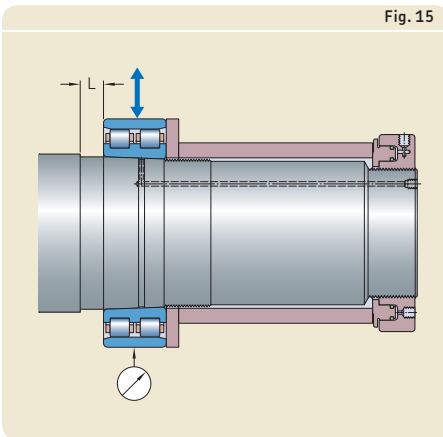

5 Mounting the bearing (final)

- Grind the pre-machined spacer ring to the required width.
- Remove the assembled bearing, mount the spacer ring, and drive up the inner ring roller and cage assembly again until it firmly abuts the spacer ring.
- Locate the inner ring using a suitable locking device.
- Heat the housing to the required temperature and mount the outer ring.

Mounting and dismounting, using the oil injection method

Particularly where large bearings are involved, it is often necessary to make provisions during the design stage, to facilitate mounting and dismounting of a bearing, or even to make it possible at all.

For super-precision cylindrical roller bearings with a bore diameter $d > 80$ mm, SKF recommends the oil injection method. With the oil injection method, oil under high pressure is injected via ducts and distribution grooves between the bearing and bearing seat to form an oil film (→ **fig. 16**). This oil film separates the mating surfaces and considerably reduces the friction between them and virtually eliminates the risk of damaging the bearing or the spindle shaft. This method is typically used when mounting or dismounting bearings directly on tapered shaft seats. Where bearings with a cylindrical bore are concerned, the oil injection method can only be used for dismounting.

To apply the oil injection method, the spindle must contain ducts and grooves (→ *Provisions for mounting and dismounting*, **page 88**).

Fig. 16

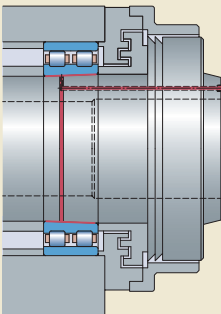

Designation system

Examples: N 1016 KPHA/HC5SP
 NN 3020 KTN9/SPVR521
 NNU 49/500 B/SPC3W33X

N	10	16	K	PHA	/	HC5	SP	
NN	30	20	K	TN9	/		SP	VR521
NNU	49	/500	B		/		SPC3	W33X

Bearing design

N Single row cylindrical roller bearing
NN Double row cylindrical roller bearing
NNU Double row cylindrical roller bearing

Dimension series

10 In accordance with ISO dimension series 10
30 In accordance with ISO dimension series 30
49 In accordance with ISO dimension series 49

Bearing size

05 (x5) 25 mm bore diameter
 to
92 (x5) 460 mm bore diameter
 from
/500 Bore diameter uncoded [mm]

Internal design and bore shape

- Cylindrical bore (no designation suffix)
B Modified internal design
K Tapered bore, taper 1:12

Cage

- Machined brass cage, roller centred (no designation suffix)
PHA Carbon fibre reinforced PEEK cage, outer ring centred
TN PA66 cage, roller centred
TN9 Glass fibre reinforced PA66 cage, roller centred
TNHA Glass fibre reinforced PEEK cage, outer ring centred

Roller material

- Carbon chromium steel (no designation suffix)
HC5 Rollers made of bearing grade silicon nitride Si₃N₄ (hybrid bearing)

Tolerance class and internal clearance

SP Dimensional accuracy in accordance with ISO tolerance class 5, running accuracy in accordance with ISO tolerance class 4
UP Dimensional accuracy in accordance with ISO tolerance class 4, running accuracy better than ISO tolerance class 4
- Standard radial internal clearance C1 (no designation suffix)
C2 Radial internal clearance greater than C1
CN Normal radial internal clearance
C3 Radial internal clearance greater than Normal

Other variants

VR521 Bearing supplied with measuring report (standard for NN 30 series bearings with d > 130 mm)
VU001 Inner ring raceway with finish-grinding allowance
W33 Annular groove and three lubrication holes in the outer ring
W33X Annular groove and six lubrication holes in the outer ring

3.1 Single row cylindrical roller bearings d 40 – 60 mm

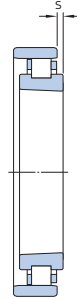
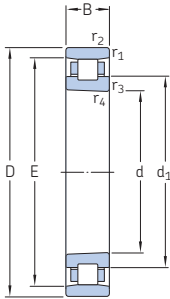

TN(9), PHA

TNHA

Principal dimensions			Basic load ratings		Fatigue load limit	Attainable speeds		Mass	Designation
d	D	B	dynamic C	static C ₀	P _u	Grease lubrica- tion	Oil-air lubrication	kg	Bearing with a tapered bore
mm			kN		kN	r/min			-
40	68	15	23,3	25	2,9	30 000	36 000	0,19	N 1008 KPHA/SP
	68	15	23,3	25	2,9	32 000	38 000	0,17	N 1008 KPHA/HC5SP
	68	15	24,2	26,5	3,05	22 000	32 000	0,19	N 1008 KTNHA/SP
	68	15	24,2	26,5	3,05	26 000	36 000	0,17	N 1008 KTNHA/HC5SP
	68	15	25,1	28	3,2	15 000	17 000	0,19	N 1008 KTN/SP
	68	15	25,1	28	3,2	18 000	20 000	0,17	N 1008 KTN/HC5SP
45	75	16	27	30	3,45	28 000	34 000	0,24	N 1009 KPHA/SP
	75	16	27	30	3,45	30 000	36 000	0,2	N 1009 KPHA/HC5SP
	75	16	28,1	31	3,65	20 000	28 000	0,24	N 1009 KTNHA/SP
	75	16	28,1	31	3,65	22 000	32 000	0,21	N 1009 KTNHA/HC5SP
	75	16	29,2	32,5	3,8	14 000	15 000	0,24	N 1009 KTN/SP
	75	16	29,2	32,5	3,8	16 000	18 000	0,22	N 1009 KTN/HC5SP
50	80	16	28,6	33,5	3,8	26 000	30 000	0,26	N 1010 KPHA/SP
	80	16	28,6	33,5	3,8	28 000	32 000	0,22	N 1010 KPHA/HC5SP
	80	16	29,7	34,5	4,05	19 000	26 000	0,26	N 1010 KTNHA/SP
	80	16	29,7	34,5	4,05	20 000	28 000	0,23	N 1010 KTNHA/HC5SP
	80	16	30,8	36,5	4,25	13 000	14 000	0,26	N 1010 KTN/SP
	80	16	30,8	36,5	4,25	15 000	17 000	0,23	N 1010 KTN/HC5SP
55	90	18	37,4	44	5,2	22 000	28 000	0,38	N 1011 KPHA/SP
	90	18	37,4	44	5,2	24 000	30 000	0,32	N 1011 KPHA/HC5SP
	90	18	39,1	46,5	5,5	17 000	24 000	0,39	N 1011 KTNHA/SP
	90	18	39,1	46,5	5,5	19 000	26 000	0,35	N 1011 KTNHA/HC5SP
	90	18	40,2	48	5,7	12 000	13 000	0,39	N 1011 KTN/SP
	90	18	40,2	48	5,7	13 000	15 000	0,35	N 1011 KTN/HC5SP
60	95	18	40,2	49	5,85	20 000	26 000	0,4	N 1012 KPHA/SP
	95	18	40,2	49	5,85	22 000	28 000	0,33	N 1012 KPHA/HC5SP
	95	18	41,3	51	6,1	16 000	22 000	0,41	N 1012 KTNHA/SP
	95	18	41,3	51	6,1	18 000	24 000	0,37	N 1012 KTNHA/HC5SP
	95	18	42,9	53	6,3	11 000	12 000	0,41	N 1012 KTN/SP
	95	18	42,9	53	6,3	12 000	14 000	0,37	N 1012 KTN/HC5SP

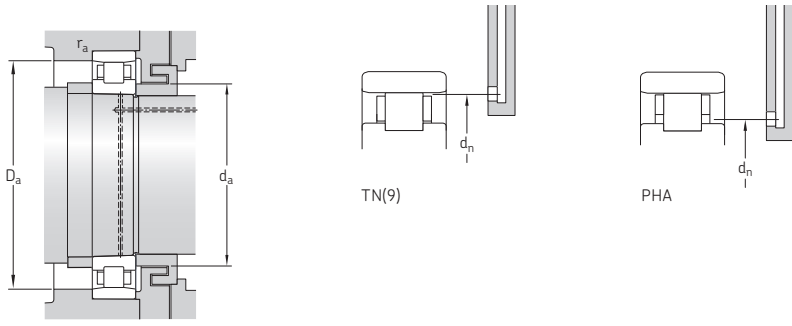

Dimensions							Abutment and fillet dimensions					Reference grease quantity ¹⁾
d	d ₁	E	r _{1,2} min.	r _{3,4} min.	s ²⁾	s ₁ ²⁾	d _a min.	D _a min.	D _a max.	r _a max.	d _n ³⁾	G _{ref}
mm							mm					cm ³
40	50,6	61	1	0,6	2	–	45	62	63	1	52,1	3,1
	50,6	61	1	0,6	2	–	45	62	63	1	52,1	3,1
	50,6	61	1	0,6	2	1,5	45	62	63	1	–	2,5
	50,6	61	1	0,6	2	1,5	45	62	63	1	–	2,5
	50,6	61	1	0,6	2	–	45	62	63	1	60	2,3
	50,6	61	1	0,6	2	–	45	62	63	1	60	2,3
45	56,3	67,5	1	0,6	2	–	50	69	70	1	57,9	4,1
	56,3	67,5	1	0,6	2	–	50	69	70	1	57,9	4,1
	56,3	67,5	1	0,6	2	1,5	50	69	70	1	–	3,2
	56,3	67,5	1	0,6	2	1,5	50	69	70	1	–	3,2
	56,3	67,5	1	0,6	2	–	50	69	70	1	66,4	2,9
	56,3	67,5	1	0,6	2	–	50	69	70	1	66,4	2,9
50	61,3	72,5	1	0,6	2	–	55	74	75	1	63	4,4
	61,3	72,5	1	0,6	2	–	55	74	75	1	63	4,4
	61,3	72,5	1	0,6	2	1,5	55	74	75	1	–	3,5
	61,3	72,5	1	0,6	2	1,5	55	74	75	1	–	3,5
	61,3	72,5	1	0,6	2	–	55	74	75	1	71,4	3,2
	61,3	72,5	1	0,6	2	–	55	74	75	1	71,4	3,2
55	68,2	81	1,1	0,6	2,5	–	61,5	82	83,5	1	70,1	6,1
	68,2	81	1,1	0,6	2,5	–	61,5	82	83,5	1	70,1	6,1
	68,2	81	1,1	0,6	2,5	1,5	61,5	82	83,5	1	–	4,9
	68,2	81	1,1	0,6	2,5	1,5	61,5	82	83,5	1	–	4,9
	68,2	81	1,1	0,6	2,5	–	61,5	82	83,5	1	79,8	4,4
	68,2	81	1,1	0,6	2,5	–	61,5	82	83,5	1	79,8	4,4
60	73,3	86,1	1,1	0,6	2,5	–	66,5	87	88,5	1	75,2	6,5
	73,3	86,1	1,1	0,6	2,5	–	66,5	87	88,5	1	75,2	6,5
	73,3	86,1	1,1	0,6	2,5	1,5	66,5	87	88,5	1	–	5,2
	73,3	86,1	1,1	0,6	2,5	1,5	66,5	87	88,5	1	–	5,2
	73,3	86,1	1,1	0,6	2,5	–	66,5	87	88,5	1	85	4,7
	73,3	86,1	1,1	0,6	2,5	–	66,5	87	88,5	1	85	4,7

1) For calculating the initial grease fill → page 101
 2) Permissible axial displacement from the normal position of one bearing ring relative to the other.
 3) For bearings equipped with a TNHA cage, contact the SKF application engineering service.

3.1 Single row cylindrical roller bearings d 65 – 90 mm

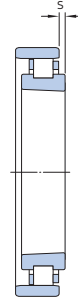
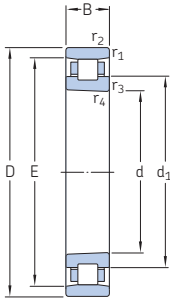

TN(9), PHA

TNHA

Principal dimensions			Basic load ratings		Fatigue load limit	Attainable speeds		Mass	Designation
d	D	B	dynamic C	static C ₀	P _u	Grease lubrica- tion	Oil-air lubrication	kg	Bearing with a tapered bore
mm			kN		kN	r/min			–
65	100	18	42,9	54	6,3	20 000	24 000	0,43	N 1013 KPHA/SP
	100	18	42,9	54	6,3	22 000	26 000	0,35	N 1013 KPHA/HC5SP
	100	18	44	56	6,55	15 000	20 000	0,44	N 1013 KTNHA/SP
	100	18	44	56	6,55	17 000	22 000	0,39	N 1013 KTNHA/HC5SP
	100	18	44,6	58,5	6,8	10 000	11 000	0,44	N 1013 KTN/SP
	100	18	44,6	58,5	6,8	11 000	13 000	0,39	N 1013 KTN/HC5SP
70	110	20	53,9	69,5	8	18 000	22 000	0,61	N 1014 KPHA/SP
	110	20	53,9	69,5	8	20 000	24 000	0,5	N 1014 KPHA/HC5SP
	110	20	55	72	8,3	13 000	19 000	0,62	N 1014 KTNHA/SP
	110	20	55	72	8,3	15 000	20 000	0,55	N 1014 KTNHA/HC5SP
	110	20	57,2	75	8,65	9 500	10 000	0,62	N 1014 KTN/SP
	110	20	57,2	75	8,65	10 000	12 000	0,55	N 1014 KTN/HC5SP
75	115	20	52,8	69,5	8,15	17 000	20 000	0,64	N 1015 KPHA/SP
	115	20	52,8	69,5	8,15	19 000	22 000	0,53	N 1015 KPHA/HC5SP
	115	20	55	72	8,5	13 000	18 000	0,65	N 1015 KTNHA/SP
	115	20	55	72	8,5	14 000	20 000	0,57	N 1015 KTNHA/HC5SP
	115	20	56,1	75	8,8	9 000	9 500	0,65	N 1015 KTN/SP
	115	20	56,1	75	8,8	9 500	11 000	0,57	N 1015 KTN/HC5SP
80	125	22	66	86,5	10,2	16 000	19 000	0,88	N 1016 KPHA/SP
	125	22	66	86,5	10,2	18 000	20 000	0,73	N 1016 KPHA/HC5SP
	125	22	67,1	90	10,6	12 000	16 000	0,88	N 1016 KTNHA/SP
	125	22	67,1	90	10,6	13 000	18 000	0,79	N 1016 KTNHA/HC5SP
	125	22	69,3	93	11	8 500	9 000	0,89	N 1016 KTN/SP
	125	22	69,3	93	11	9 000	10 000	0,79	N 1016 KTN/HC5SP
85	130	22	70,4	98	11,2	11 000	16 000	0,89	N 1017 KTNHA/SP
	130	22	70,4	98	11,2	13 000	17 000	0,79	N 1017 KTNHA/HC5SP
	130	22	73,7	102	11,6	8 000	8 500	0,9	N 1017 KTN9/SP
	130	22	73,7	102	11,6	9 000	10 000	0,8	N 1017 KTN9/HC5SP
90	140	24	76,5	104	12,5	10 000	14 000	1,2	N 1018 KTNHA/SP
	140	24	76,5	104	12,5	12 000	16 000	1,05	N 1018 KTNHA/HC5SP
	140	24	79,2	108	12,9	7 000	8 000	1,2	N 1018 KTN9/SP
	140	24	79,2	108	12,9	8 500	9 500	1,1	N 1018 KTN9/HC5SP

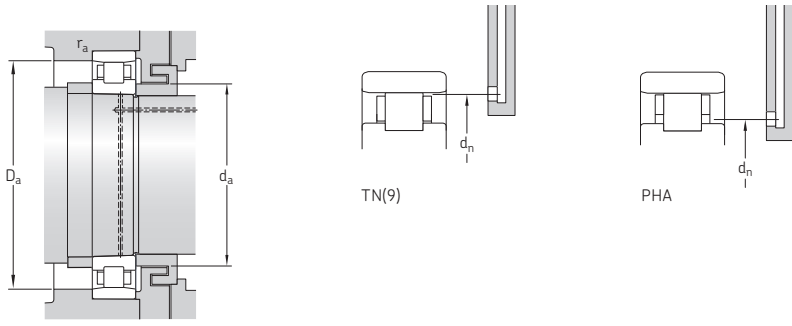

Dimensions							Abutment and fillet dimensions					Reference grease quantity ¹⁾
d	d ₁	E	r _{1,2} min.	r _{3,4} min.	s ²⁾	s ₁ ²⁾	d _a min.	D _a min.	D _a max.	r _a max.	d _n ³⁾	G _{ref}
mm							mm					cm ³
65	78,2	91	1,1	0,6	2,5	–	71,5	92	93,5	1	80,1	6,9
	78,2	91	1,1	0,6	2,5	–	71,5	92	93,5	1	80,1	6,9
	78,2	91	1,1	0,6	2,5	1,5	71,5	92	93,5	1	–	5,5
	78,2	91	1,1	0,6	2,5	1,5	71,5	92	93,5	1	–	5,5
	78,2	91	1,1	0,6	2,5	–	71,5	92	93,5	1	89,7	5
	78,2	91	1,1	0,6	2,5	–	71,5	92	93,5	1	89,7	5
70	85,6	100	1,1	0,6	3	–	76,5	101	103,5	1	87,7	9,2
	85,6	100	1,1	0,6	3	–	76,5	101	103,5	1	87,7	9,2
	85,6	100	1,1	0,6	3	1,5	76,5	101	103,5	1	–	7,2
	85,6	100	1,1	0,6	3	1,5	76,5	101	103,5	1	–	7,2
	85,6	100	1,1	0,6	3	–	76,5	101	103,5	1	98,5	6,7
	85,6	100	1,1	0,6	3	–	76,5	101	103,5	1	98,5	6,7
75	90,6	105	1,1	0,6	3	–	81,5	106	108,5	1	92,7	9,6
	90,6	105	1,1	0,6	3	–	81,5	106	108,5	1	92,7	9,6
	90,6	105	1,1	0,6	3	1,5	81,5	106	108,5	1	–	7,7
	90,6	105	1,1	0,6	3	1,5	81,5	106	108,5	1	–	7,7
	90,6	105	1,1	0,6	3	–	81,5	106	108,5	1	103,5	7,1
	90,6	105	1,1	0,6	3	–	81,5	106	108,5	1	103,5	7,1
80	97	113	1,1	0,6	3	–	86,5	114	118,5	1	99,3	13
	97	113	1,1	0,6	3	–	86,5	114	118,5	1	99,3	13
	97	113	1,1	0,6	3	1	86,5	114	118,5	1	–	9,8
	97	113	1,1	0,6	3	1	86,5	114	118,5	1	–	9,8
	97	113	1,1	0,6	3	–	86,5	114	118,5	1	111,4	9
	97	113	1,1	0,6	3	–	86,5	114	118,5	1	111,4	9
85	102	118	1,1	0,6	3	1	91,5	119	123,5	1	–	10
	102	118	1,1	0,6	3	1	91,5	119	123,5	1	–	10
	102	118	1,1	0,6	3	–	91,5	119	123,5	1	116,5	9,2
	102	118	1,1	0,6	3	–	91,5	119	123,5	1	116,5	9,2
90	109,4	127	1,5	1	3	1	98	129	132	1,5	–	14
	109,4	127	1,5	1	3	1	98	129	132	1,5	–	14
	109,4	127	1,5	1	3	–	98	129	132	1,5	125,4	12
	109,4	127	1,5	1	3	–	98	129	132	1,5	125,4	12

1) For calculating the initial grease fill → page 101
 2) Permissible axial displacement from the normal position of one bearing ring relative to the other.
 3) For bearings equipped with a TNHA cage, contact the SKF application engineering service.

3.1 Single row cylindrical roller bearings d 95 – 120 mm

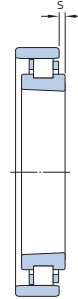
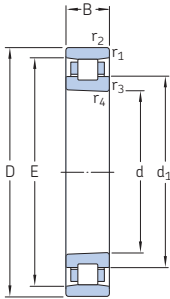

TN(9)

TNHA

Principal dimensions			Basic load ratings		Fatigue load limit	Attainable speeds		Mass	Designation
d	D	B	dynamic C	static C ₀	P _u	Grease lubrica- tion	Oil-air lubrication		Bearing with a tapered bore
mm			kN		kN	r/min		kg	–
95	145	24	80,9	112	13,4	10 000	14 000	1,25	N 1019 KTNHA/SP
	145	24	80,9	112	13,4	11 000	15 000	1,1	N 1019 KTNHA/HC5SP
	145	24	84,2	116	14	6 700	7 500	1,25	N 1019 KTN9/SP
	145	24	84,2	116	14	8 000	9 000	1,1	N 1019 KTN9/HC5SP
100	150	24	85,8	120	14,3	9 500	13 000	1,3	N 1020 KTNHA/SP
	150	24	85,8	120	14,3	11 000	15 000	1,15	N 1020 KTNHA/HC5SP
	150	24	88	125	14,6	6 700	7 500	1,3	N 1020 KTN9/SP
	150	24	88	125	14,6	7 500	8 500	1,15	N 1020 KTN9/HC5SP
105	160	26	108	146	17,3	9 000	13 000	1,65	N 1021 KTNHA/SP
	160	26	108	146	17,3	10 000	14 000	1,45	N 1021 KTNHA/HC5SP
	160	26	110	153	18	6 300	7 000	1,65	N 1021 KTN9/SP
	160	26	110	153	18	7 000	8 000	1,45	N 1021 KTN9/HC5SP
110	170	28	125	173	20	8 500	12 000	2,05	N 1022 KTNHA/SP
	170	28	125	173	20	9 500	13 000	1,8	N 1022 KTNHA/HC5SP
	170	28	128	180	20,8	5 600	6 300	2,05	N 1022 KTN9/SP
	170	28	128	180	20,8	6 700	7 500	1,8	N 1022 KTN9/HC5SP
120	180	28	130	186	21,2	8 000	11 000	2,2	N 1024 KTNHA/SP
	180	28	130	186	21,2	9 000	12 000	1,9	N 1024 KTNHA/HC5SP
	180	28	134	196	22	5 300	6 000	2,2	N 1024 KTN9/SP
	180	28	134	196	22	6 300	7 000	1,9	N 1024 KTN9/HC5SP

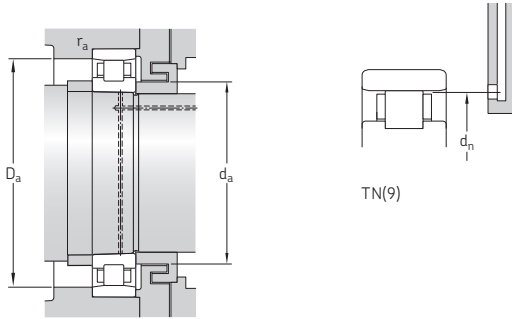

Dimensions							Abutment and fillet dimensions					Reference grease quantity ¹⁾
d	d ₁	E	r _{1,2} min.	r _{3,4} min.	s ²⁾	s ₁ ²⁾	d _a min.	D _a min.	D _a max.	r _a max.	d _n ³⁾	G _{ref}
mm							mm					cm ³
95	114,4	132	1,5	1	3	1	103	134	137	1,5	–	14
	114,4	132	1,5	1	3	1	103	134	137	1,5	–	14
	114,4	132	1,5	1	3	–	103	134	137	1,5	130,3	13
	114,4	132	1,5	1	3	–	103	134	137	1,5	130,3	13
100	119,4	137	1,5	1	3	1	108	139	142	1,5	–	14
	119,4	137	1,5	1	3	1	108	139	142	1,5	–	14
	119,4	137	1,5	1	3	–	108	139	142	1,5	135,3	13
	119,4	137	1,5	1	3	–	108	139	142	1,5	135,3	13
105	125,2	146	2	1,1	3	1	114	148	151	2	–	18
	125,2	146	2	1,1	3	1	114	148	151	2	–	18
	125,2	146	2	1,1	3	–	114	148	151	2	144,1	18
	125,2	146	2	1,1	3	–	114	148	151	2	144,1	18
110	132,6	155	2	1,1	3	1	119	157	161	2	–	21
	132,6	155	2	1,1	3	1	119	157	161	2	–	21
	132,6	155	2	1,1	3	–	119	157	161	2	153	21
	132,6	155	2	1,1	3	–	119	157	161	2	153	21
120	142,6	165	2	1,1	3	1	129	167	171	2	–	34
	142,6	165	2	1,1	3	1	129	167	171	2	–	34
	142,6	165	2	1,1	3	–	129	167	171	2	162,9	22
	142,6	165	2	1,1	3	–	129	167	171	2	162,9	22

1) For calculating the initial grease fill → page 101

2) Permissible axial displacement from the normal position of one bearing ring relative to the other.

3) For bearings equipped with a TNHA cage, contact the SKF application engineering service.

3.2 Double row cylindrical roller bearings d 25 – 105 mm

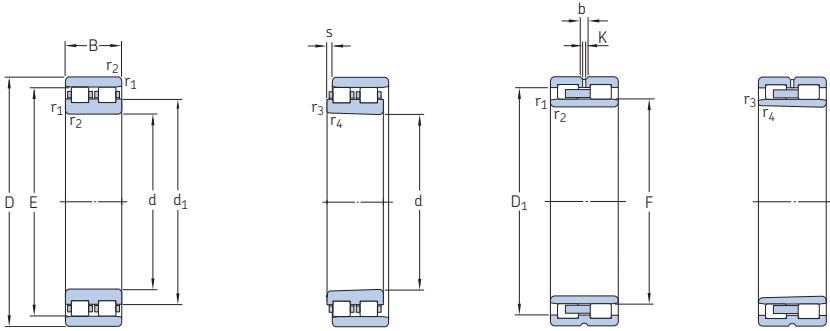

NN 30 TN(9)

NN 30 KTN(9)

NNU 49 B/W33

NNU 49 BK/W33

Principal dimensions			Basic load ratings		Fatigue load limit P_u	Attainable speeds		Mass	Designations Bearing with a tapered bore	cylindrical bore
d	D	B	dynamic C	static C_0		Grease lubrication	Oil-air lubrication			
mm			kN		kN	r/min	kg	–		
25	47	16	26	30	3,15	19 000	22 000	0,12	NN 3005 K/SP	NN 3005/SP
30	55	19	30,8	37,5	4	17 000	19 000	0,19	NN 3006 KTN/SP	NN 3006 TN/SP
35	62	20	39,1	50	5,4	14 000	16 000	0,25	NN 3007 K/SP	NN 3007/SP
40	68	21	42,9	56	6,4	13 000	15 000	0,3	NN 3008 KTN/SP	NN 3008 TN/SP
45	75	23	50,1	65,5	7,65	12 000	14 000	0,38	NN 3009 KTN/SP	NN 3009 TN/SP
50	80	23	52,8	73,5	8,5	11 000	13 000	0,42	NN 3010 KTN/SP	NN 3010 TN/SP
55	90	26	69,3	96,5	11,6	10 000	12 000	0,62	NN 3011 KTN/SP	NN 3011 TN/SP
60	95	26	73,7	106	12,7	9 500	11 000	0,66	NN 3012 KTN/SP	NN 3012 TN/SP
65	100	26	76,5	116	13,7	9 000	10 000	0,71	NN 3013 KTN/SP	NN 3013 TN/SP
70	110	30	96,8	150	17,3	8 000	9 000	1	NN 3014 KTN/SP	NN 3014 TN/SP
75	115	30	96,8	150	17,6	7 500	8 500	1,1	NN 3015 KTN/SP	NN 3015 TN/SP
80	125	34	119	186	22	7 000	8 000	1,5	NN 3016 KTN/SP	NN 3016 TN/SP
85	130	34	125	204	23,2	6 700	7 500	1,55	NN 3017 KTN9/SP	NN 3017 TN9/SP
90	140	37	138	216	26	6 300	7 000	1,95	NN 3018 KTN9/SP	NN 3018 TN9/SP
95	145	37	142	232	27,5	6 000	6 700	2,05	NN 3019 KTN9/SP	NN 3019 TN9/SP
100	140	40	128	255	29	5 600	6 300	1,9	NNU 4920 BK/SPW33	NNU 4920 B/SPW33
	150	37	151	250	29	5 600	6 300	2,1	NN 3020 KTN9/SP	NN 3020 TN9/SP
105	145	40	130	260	30	5 300	6 000	2	NNU 4921 BK/SPW33	NNU 4921 B/SPW33
	160	41	190	305	36	5 300	6 000	2,7	NN 3021 KTN9/SP	NN 3021 TN9/SP

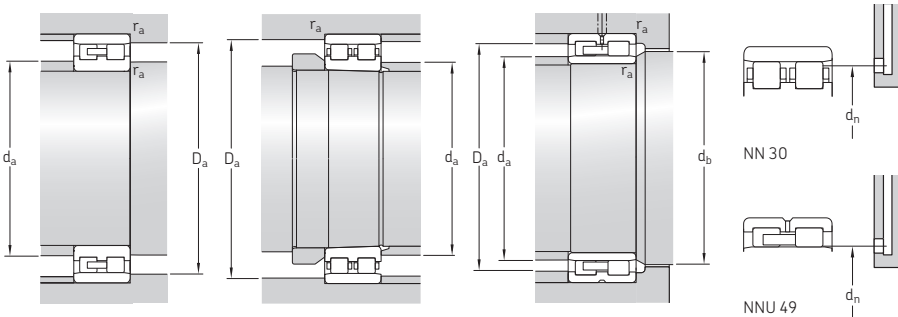

Dimensions						Abutment and fillet dimensions							Reference grease quantity ¹⁾			
d	d ₁ , D ₁	E, F	b	K	r _{1,2} min.	r _{3,4} min.	s ²⁾	d _a min.	d _a max.	d _b min.	D _a min.	D _a max.	r _a max.	d _n	G _{ref}	
mm								mm							cm ³	
25	33,7	41,3	-	-	0,6	0,3	1	29	-	-	42	43	0,6	40,5	0,9	
30	40,1	48,5	-	-	1	0,6	1,5	35	-	-	49	50	1	47,6	1	
35	45,8	55	-	-	1	0,6	1,5	40	-	-	56	57	1	54	1,9	
40	50,6	61	-	-	1	0,6	1,5	45	-	-	62	63	1	60	1,8	
45	56,3	67,5	-	-	1	0,6	1,5	50	-	-	69	70	1	66,4	2,4	
50	61,3	72,5	-	-	1	0,6	1,5	55	-	-	74	75	1	71,4	2,7	
55	68,2	81	-	-	1,1	0,6	1,5	61,5	-	-	82	83,5	1	79,8	3,6	
60	73,3	86,1	-	-	1,1	0,6	1,5	66,5	-	-	87	88,5	1	85	3,8	
65	78,2	91	-	-	1,1	0,6	1,5	71,5	-	-	92	93,5	1	89,7	4,1	
70	85,6	100	-	-	1,1	0,6	2	76,5	-	-	101	103,5	1	98,5	5,9	
75	90,6	105	-	-	1,1	0,6	2	81,5	-	-	106	108,5	1	103,5	6,3	
80	97	113	-	-	1,1	0,6	2	86,5	-	-	114	118,5	1	111,4	8,3	
85	102	118	-	-	1,1	0,6	2	91,5	-	-	119	123,5	1	116,5	8,4	
90	109,4	127	-	-	1,5	1	2	98	-	-	129	132	1,5	125,4	11	
95	114,4	132	-	-	1,5	1	2	103	-	-	134	137	1,5	130,3	12	
100	125,8	113	5,5	3	1,1	0,6	1,1	106	111	116	-	133,5	1	113,8	13	
	119,4	137	-	-	1,5	1	2	108	-	-	139	142	1,5	135,3	12	
105	130,8	118	5,5	3	1,1	0,6	1,1	111	116	121	-	138,5	1	119	15	
	125,2	146	-	-	2	1,1	2	115	-	-	148	150	2	144,1	17	

1) For calculating the initial grease fill → page 101

2) Permissible axial displacement from the normal position of one bearing ring relative to the other.

3.2 Double row cylindrical roller bearings d 110 – 240 mm

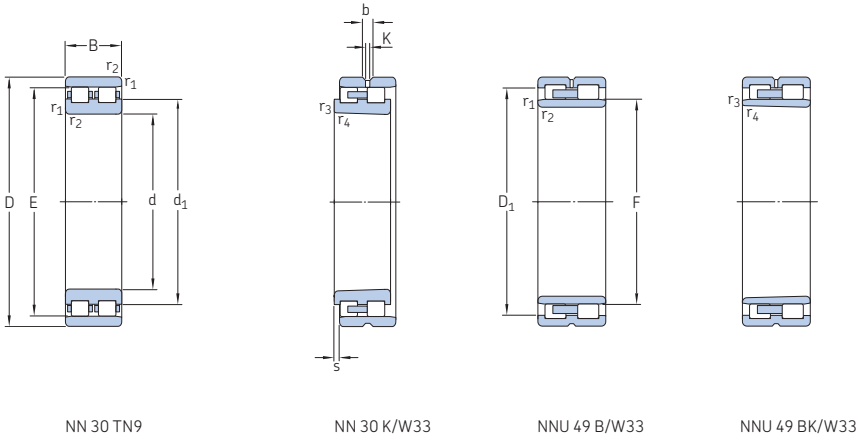

Principal dimensions	Basic load ratings		Fatigue load limit P_u	Attainable speeds		Mass	Designations Bearing with a tapered bore	cylindrical bore		
	dynamic C	static C_0		Grease lubrication	Oil-air lubrication					
d	D	B	kN	kN	r/min	kg	–	–		
mm										
110	150	40	132	270	30	5 300	6 000	2,05	NNU 4922 BK/SPW33	NNU 4922 B/SPW33
	170	45	220	360	41,5	5 000	5 600	3,4	NN 3022 KTN9/SP	NN 3022 TN9/SP
120	165	45	176	340	37,5	4 800	5 300	2,8	NNU 4924 BK/SPW33	NNU 4924 B/SPW33
	180	46	229	390	44	4 800	5 300	3,7	NN 3024 KTN9/SP	NN 3024 TN9/SP
130	180	50	187	390	41,5	4 300	4 800	3,85	NNU 4926 BK/SPW33	NNU 4926 B/SPW33
	200	52	292	500	55	4 300	4 800	5,55	NN 3026 KTN9/SP	NN 3026 TN9/SP
140	190	50	190	400	41,5	4 000	4 500	4,1	NNU 4928 BK/SPW33	NNU 4928 B/SPW33
	210	53	297	520	56	4 000	4 500	6	NN 3028 K/SPW33	–
150	210	60	330	655	71	3 800	4 300	6,25	NNU 4930 B/SPW33	NNU 4930 BK/SPW33
	225	56	330	570	62	3 800	4 300	7,3	NN 3030 K/SPW33	–
160	220	60	330	680	72	3 600	4 000	6,6	NNU 4932 BK/SPW33	NNU 4932 B/SPW33
	240	60	369	655	69,5	3 600	4 000	8,8	NN 3032 K/SPW33	–
170	230	60	336	695	73,5	3 400	3 800	6,95	NNU 4934 BK/SPW33	NNU 4934 B/SPW33
	260	67	457	815	83	3 200	3 600	12	NN 3034 K/SPW33	–
180	250	69	402	850	88	3 000	3 400	10,5	NNU 4936 BK/SPW33	NNU 4936 B/SPW33
	280	74	561	1 000	102	3 000	3 400	16	NN 3036 K/SPW33	–
190	260	69	402	880	90	2 800	3 200	11	NNU 4938 BK/SPW33	NNU 4938 B/SPW33
	290	75	594	1 080	108	2 800	3 200	17	NN 3038 K/SPW33	–
200	280	80	484	1 040	106	2 600	3 000	15	NNU 4940 BK/SPW33	NNU 4940 B/SPW33
	310	82	644	1 140	118	2 600	3 000	21	NN 3040 K/SPW33	–
220	300	80	512	1 140	114	2 400	2 800	16,5	NNU 4944 BK/SPW33	NNU 4944 B/SPW33
	340	90	809	1 460	143	2 400	2 800	27,5	NN 3044 K/SPW33	–
240	320	80	528	1 220	118	2 200	2 600	17,5	NNU 4948 BK/SPW33	NNU 4948 B/SPW33
	360	92	842	1 560	153	2 200	2 600	30,5	NN 3048 K/SPW33	–

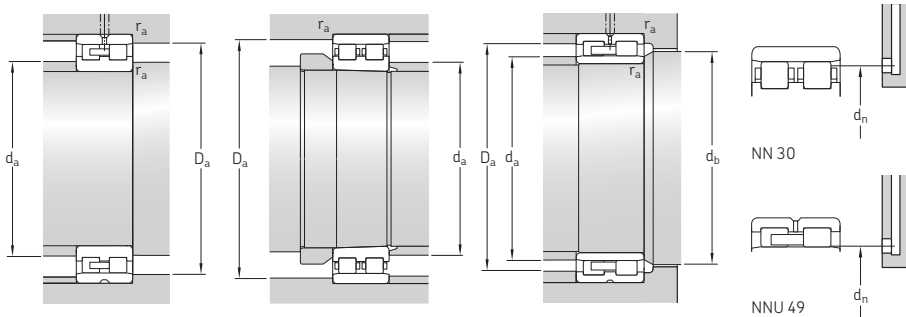

Dimensions						Abutment and fillet dimensions						Reference grease quantity ¹⁾				
d	d ₁ , D ₁	E, F	b	K	r _{1,2} min.	r _{3,4} min.	s ²⁾	d _a min.	d _a max.	d _b min.	D _a min.	D _a max.	r _a max.	d _n	G _{ref}	
mm																cm ³
110	135,8	123	5,5	3	1,1	0,6	1,1	116	121	126	–	143,5	1	124	17	
	132,6	155	–	–	2	1,1	3	120	–	–	157	160	2	153	20	
120	150,5	134,5	5,5	3	1,1	0,6	1,1	126	133	137	–	158,5	1	136,8	27	
	142,6	165	–	–	2	1,1	3	130	–	–	167	170	2	162,9	23	
130	162	146	5,5	3	1,5	1	2,2	137	144	149	–	172	1,5	147	31	
	156,4	182	–	–	2	1,1	3	140	–	–	183	190	2	179,6	34	
140	172	156	5,5	3	1,5	1	2,2	147	154	159	–	182	1,5	157	45	
	166,5	192	8,7	4,5	2	1,1	2,5	150	–	–	194	200	2	188	52	
150	190,9	168,5	5,5	3	2	1	2	160	166	172	–	200	2	169,9	57	
	179	206	8,7	4,5	2,1	1,1	2,5	161	–	–	208	214	2	201,7	63	
160	200,9	178,5	5,5	3	2	2	2	170	176	182	–	210	2	179,8	63	
	190	219	8,5	4,5	2,1	1,1	2,5	171	–	–	221	229	2	214,4	78	
170	210,9	188,5	5,5	3	2	2	2	180	186	192	–	220	2	189,8	72	
	204	236	8,9	4,5	2,1	1,1	2,5	181	–	–	238	249	2	230,8	105	
180	226,05	202	8,3	3	2	1	1,1	190	199	205	–	240	2	203,5	81	
	218,2	255	11,3	6	2,1	1,1	3	191	–	–	257	269	2	248,9	138	
190	236	212	8,3	3	2	1	1,1	200	209	215	–	250	2	213	85	
	228,2	265	11,3	6	2,1	1,1	3	201	–	–	267	279	2	258,9	144	
200	252,2	225	11,1	3	2,1	1,1	3,7	211	222	228	–	269	2	227	117	
	242	282	12,2	6	2,1	1,1	3	211	–	–	285	299	2	275,3	191	
220	272,2	245	11,1	3	2,1	1,1	3,7	231	242	249	–	289	2	247	150	
	265,2	310	15	7,5	3	1,1	2	233	–	–	313	327	2,5	302,4	260	
240	292,2	265,3	11,1	3	2,1	1,1	3,7	251	262	269	–	309	2	267	171	
	285,2	330	15,2	7,5	3	1,1	2	253	–	–	333	347	2,5	322,4	288	

1) For calculating the initial grease fill → page 101

2) Permissible axial displacement from the normal position of one bearing ring relative to the other.

3.2 Double row cylindrical roller bearings

d 260 – 670 mm

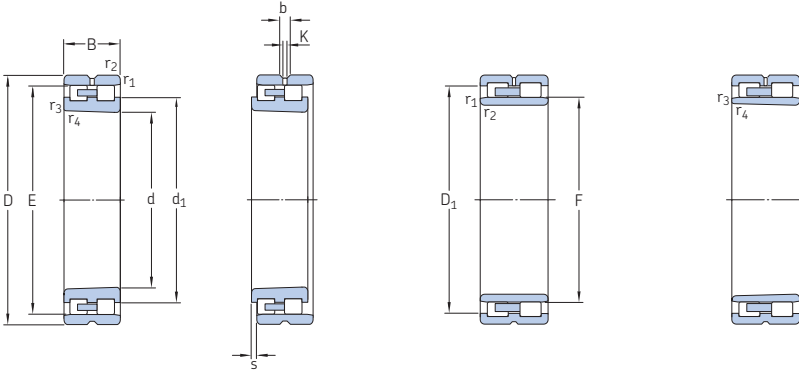

NN 30 K/W33

NNU 49 B/W33

NNU 49 BK/W33

Principal dimensions			Basic load ratings		Fatigue load limit	Attainable speeds		Mass	Designations	cylindrical bore
d	D	B	dynamic C	static C ₀	P _u	Grease lubrication	Oil-air lubrication	Bearing with a tapered bore		
mm			kN		kN	r/min		kg	–	
260	360	100	748	1 700	163	2 000	2 400	30,5	NNU 4952 BK/SPW33	NNU 4952 B/SPW33
	400	104	1 020	1 930	183	2 000	2 400	44	NN 3052 K/SPW33	–
280	380	100	765	1 800	170	1 900	2 200	32,5	NNU 4956 BK/SPW33	NNU 4956 B/SPW33
	420	106	1 080	2 080	196	1 900	2 200	47,5	NN 3056 K/SPW33	–
300	420	118	1 020	2 360	224	1 800	2 000	50	NNU 4960 BK/SPW33	NNU 4960 B/SPW33
	460	118	1 250	2 400	228	1 700	1 900	66,5	NN 3060 K/SPW33	–
320	440	118	1 060	2 500	232	1 700	1 900	50	NNU 4964 BK/SPW33	NNU 4964 B/SPW33
	480	121	1 320	2 600	240	1 600	1 800	71	NN 3064 K/SPW33	–
340	460	118	1 100	2 650	245	1 500	1 700	53	NNU 4968 BK/SPW33	NNU 4968 B/SPW33
	520	133	1 650	3 250	290	1 400	1 600	94,5	NN 3068 K/SPW33	–
360	480	118	1 120	2 800	250	1 500	1 700	55	NNU 4972 BK/SPW33	NNU 4972 B/SPW33
	540	134	1 720	3 450	310	1 300	1 500	102	NN 3072 K/SPW33	–
380	520	140	1 450	3 600	320	1 300	1 500	83,5	NNU 4976 BK/SPW33	NNU 4976 B/SPW33
	560	135	1 680	3 450	305	1 300	1 500	105	NN 3076 K/SPW33	–
400	540	140	1 470	3 800	335	1 300	1 500	87,5	NNU 4980 BK/SPW33	NNU 4980 B/SPW33
	600	148	2 160	4 500	380	1 200	1 400	135	NN 3080 K/SPW33	–
420	560	140	1 510	4 000	345	1 200	1 400	91	NNU 4984 BK/SPW33	NNU 4984 B/SPW33
	620	150	2 120	4 500	380	1 100	1 300	140	NN 3084 K/SPW33	–
460	620	160	2 090	5 500	465	1 000	1 200	130	NNU 4992 BK/SPW33	NNU 4992 B/SPW33
	680	163	2 600	5 500	440	1 000	1 200	190	NN 3092 K/SPW33	–
500	670	170	2 330	6 100	490	950	1 100	165	NNU 49/500 BK/SPW33X	NNU 49/500 B/SPW33X
600	800	200	3 580	10 200	800	800	900	280	NNU 49/600 BK/SPW33X	NNU 49/600 B/SPW33X
670	900	230	4 950	13 700	930	700	800	410	NNU 49/670 BK/SPW33X	NNU 49/670 B/SPW33X

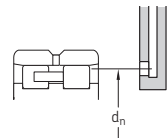
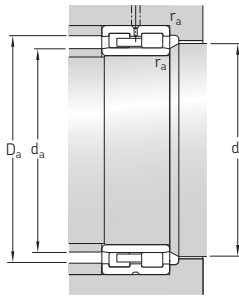
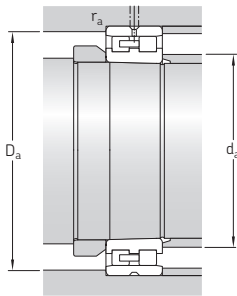

NN 30

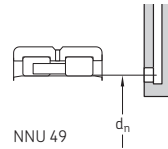

NNU 49

Dimensions						Abutment and fillet dimensions							Reference grease quantity ^{1) 3)}			
d	d ₁ , D ₁	E, F	b	K	r _{1,2} min.	s ²⁾	d _a min.	d _a max.	d _b min.	D _a min.	D _a max.	r _a max.	d _n ³⁾	G _{ref}	G _{ref}	
mm															cm ³	
260	325,6	292	13,9	3	2,1	1,1	4,5	271	288	296	–	349	2	294,5	366	
	312,8	364	15,3	7,5	4	1,5	5	275	–	–	367	384	3	355,2	392	
280	345,6	312	13,9	3	2,1	1,1	4,5	291	308	316	–	369	2	313,5	384	
	332,8	384	15,3	7,5	4	1,5	5	295	–	–	387	404	3	375,3	420	
300	379	339	16,7	3	3	1,1	5,5	313	335	343	–	407	2,5	362	420	
	359	418	16,7	9	4	2	8,9	315	–	–	421	445	3	–	–	
320	399	359	16,7	9	3	2	5,5	333	355	363	–	427	2,5	–	–	
	379	438	16,7	9	4	2	8,9	335	–	–	442	465	3	–	–	
340	419	379	16,7	9	3	1,5	5,5	353	375	383	–	447	2,5	–	–	
	408	473	16,7	9	5	3	10,9	358	–	–	477	502	4	–	–	
360	439	399	16,7	9	3	1,5	5,5	373	395	403	–	467	2,5	–	–	
	428	493	16,7	9	5	2,5	10,9	378	–	–	497	520	4	–	–	
380	470,8	426	16,7	9	4	2,5	5,5	395	421	431	–	505	3	–	–	
	448	513	16,7	9	5	2,5	11,9	398	–	–	517	542	4	–	–	
400	490,8	446	16,7	9	4	2,5	5,5	415	441	451	–	524	3	–	–	
	475	549	16,7	9	5	2,5	12,4	418	–	–	553	582	4	–	–	
420	510,5	466	16,7	9	4	2	5,5	435	461	471	–	544	3	–	–	
	495	569	16,7	9	5	2	12,4	438	–	–	574	602	4	–	–	
460	567	510	16,7	9	4	2	3,2	475	504	515	–	605	3	–	–	
	542	624	22,3	12	6	3	14,4	483	–	–	627	657	5	–	–	
500	611,6	554	22,3	12	5	3	3,5	548	548	559	–	652	4	–	–	
600	733,2	666	22,3	12	5	2,5	5,5	648	662	672	–	782	4	–	–	
670	821,2	738	22,3	12	6	3	6	693	732	744	–	877	5	–	–	

1) For calculating the initial grease fill → page 101

2) Permissible axial displacement from the normal position of one bearing ring relative to the other.

3) For bearings with D > 420 mm, contact the SKF application engineering service.



Super-precision bearing

Double direction angular contact thrust ball bearings

Designs and variants	302	Product table	
Basic design bearings, BTW series	303	4.1 Double direction angular contact thrust ball bearings	312
High-speed design bearings, BTM series	303		
Hybrid bearings	304		
Cages	304		
Markings on bearings	305		
Identification numbers	305		
Additional markings on BTM series bearings	305		
Bearing data	306		
(Boundary dimensions, tolerances)			
Preload	308		
Effect of interference on preload	308		
Axial stiffness	309		
Equivalent bearing loads	310		
Attainable speeds	310		
Mounting	310		
Designation system	311		
		More information	
		Bearing life and load ratings	33
		Requisite minimum load	34
		Chamfer dimension limits	47
		Materials	51
		Design considerations	57
		Lubrication	99
		Mounting and dismounting	123
		Bearing storage	125

SKF double direction angular contact thrust ball bearings are designed to locate spindle shafts axially in both directions. These bearings are intended for mounting in combination with cylindrical roller bearings in the NN 30 K or N 10 K series in the same housing bore (→ **fig. 1**). This bearing combination simplifies machining of the housing bore.

Double direction angular contact thrust ball bearings are manufactured with the same nominal bore size and outside diameter as corresponding cylindrical roller bearings. However, the outside diameter tolerance of the housing washers, combined with the housing bore diameter and geometric tolerances recommended for super-precision cylindrical roller bearings under light to normal load and rotating inner ring load (→ *Recommended shaft and housing fits*, **page 70**) will result in an appropriate radial clearance in the housing bore. This clearance is sufficient to prevent radial loads from acting on the thrust bearing provided that its outer ring is not axially clamped in the housing.

Designs and variants

SKF supplies two designs of double direction angular contact thrust ball bearings:

- the basic design (BTW series, → **fig. 2**) for maximum load carrying capacity and maximum system rigidity for shaft diameters from 35 to 200 mm
- the high-speed design (BTM series, → **fig. 3**) for maximum speed capability for shaft diameters from 60 to 180 mm

Both designs are available either with steel balls or ceramic balls (hybrid bearings).

BTM and BTW series bearings share the same bore and outside diameters. But BTM

Fig. 1

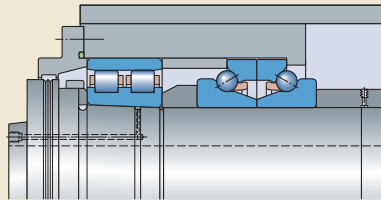
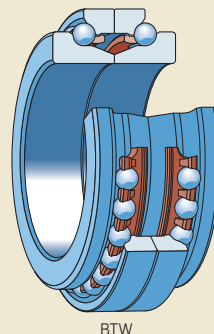

Fig. 2



series bearings have a 25% lower bearing height (→ **fig. 4**), which makes them particularly suitable for compact arrangements. They do not have the same load carrying capacity and axial stiffness as bearings in the BTW series, but can operate at higher speeds.

Basic design bearings, BTW series

Bearings in the BTW series (→ **fig. 2**) consist of two single row angular contact thrust ball bearings with a 60° contact angle, arranged back-to-back. This configuration, combined with the large number of balls, enables these bearings to accommodate high axial loads in both directions and provides a high degree of system rigidity. Bearings in the BTW series are separable. When the shaft washers are pressed together, preload within a predetermined range will result.

On request, bearings in the BTW series can be provided with an annular groove and three lubrication holes in the housing washer (designation suffix W33, → **table 1, page 304**). They can also be supplied with a larger bore diameter so that they can be mounted immediately adjacent to the large diameter side of a cylindrical roller bearing with a tapered bore (e.g. BTW 60 CATN9/SP).

High-speed design bearings, BTM series

Bearings in the BTM series (→ **fig. 3**) consist of two non-separable single row angular contact ball bearings arranged back-to-back. They are designed to accommodate axial loads in both directions. When the inner rings are pressed together, preload within a predetermined range will result.

These high-speed design bearings are available with two different contact angles:

- a 30° contact angle, designation suffix A
- a 40° contact angle, designation suffix B

Bearings with a 30° contact angle can accommodate higher speeds while bearings with a 40° contact angle are more suitable for applications that require a higher degree of axial rigidity.

According to the ISO definition, BTM series bearings are radial bearings because they have a 30° or 40° contact angle. However, since these bearings are only intended to accommodate axial loads, only their basic load rating in the axial direction is listed in the product tables (→ **page 312**).

Fig. 3

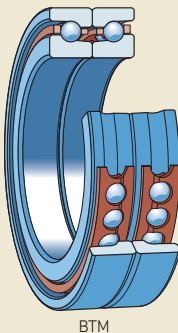

Fig. 4

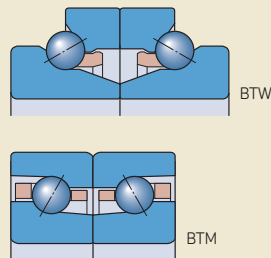
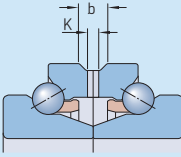

Table 1

Annular groove and lubrication hole dimensions for BTW .. W33 series bearings



Bores diameter	Dimensions	
d	b	K
mm	mm	
35	5,5	3
40	5,5	3
45	5,5	3
50	5,5	3
55	5,5	3
60	5,5	3
65	5,5	3
70	5,5	3
75	5,5	3
80	8,4	4,5
85	8,4	4,5
90	8,4	4,5
95	8,4	4,5
100	8,4	4,5
110	8,4	4,5
120	8,4	4,5
130	11,2	6
140	11,2	6
150	14	7,5
160	14	7,5
170	14	7,5
180	16,8	9
190	16,8	9
200	16,8	9

Hybrid bearings

Hybrid angular contact thrust ball bearings (designation suffix HC) have rings made of bearing steel and rolling elements made of bearing grade silicon nitride (ceramic). As ceramic balls are lighter and have a higher modulus of elasticity and lower coefficient of thermal expansion than steel balls, hybrid bearings can provide the following advantages:

- higher degree of rigidity
- higher speed capability
- reduced centrifugal and inertial forces within the bearing
- minimized stress at the outer ring rolling contacts at high speeds
- reduced frictional heat
- less energy consumption
- extended bearing and grease service life
- less prone to skid smearing damage and cage damage when subjected to frequent rapid starts and stops
- less sensitive to temperature differences within the bearing
- more accurate preload control

For additional information about silicon nitride, refer to *Materials for bearing rings and rolling elements* (→ page 51).

Cages

Bearings in the BTW series are fitted as standard with the following cages:

- $d \leq 130$ mm
two glass fibre reinforced PA66 cages, snap-type, ball centred, designation suffix TN9
- $d \geq 140$ mm
two machined brass cages, snap-type, ball centred, designation suffix M

Bearings in the BTM series are fitted as standard with the following cages:

- $d \leq 130$ mm
two glass fibre reinforced PA66 cages, window-type, ball centred, designation suffix TN9
- $d \geq 140$ mm
two machined brass cages, window-type, ball centred, designation suffix M

The cages enable the preloaded bearings to run reliably at high speeds and to withstand rapid starts and stops as well as alternating loads. They also provide good grease retention.

For information about the suitability of cages, refer to *Cage materials* (→ page 55).

Markings on bearings

Each super-precision double direction angular contact thrust ball bearing has various markings on the side faces of the washers/rings (→ fig. 5):

- 1 SKF trademark
- 2 Complete designation of the bearing
- 3 Country of manufacture
- 4 Date of manufacture, coded
- 5 Identification/serial number of the shaft washer / inner ring
- 6 Identification number on the housing washer (for BTW series only)

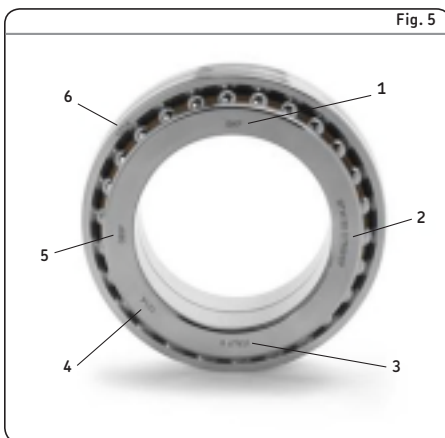

Identification numbers on BTW series bearings

Identification numbers on the washers indicate bearing components that must be kept together as supplied. To distinguish the two halves of BTW series bearing washers, the identification numbers are followed by the letters "A" or "B" (e.g. 121A in fig. 5).

Additional markings on BTM series bearings

A "V-shaped" marking on the outside surface of the outer rings indicates how the bearings should be mounted to obtain the proper preload in the set (→ fig. 6).

The deviation of the mean bore diameter from nominal in microns is marked on the inner ring side face.

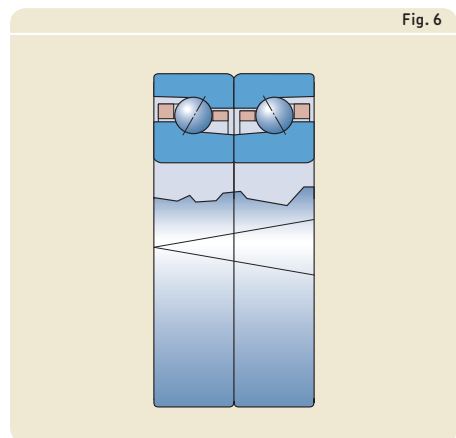

Bearing data

Boundary dimensions	<ul style="list-style-type: none"> • Bore and outside diameters in accordance with ISO 15, diameter series 0 for radial bearings • Remaining boundary dimensions not standardized, but common in the marketplace
Tolerances For additional information (→ page 47)	<p>BTW series bearings</p> <ul style="list-style-type: none"> • SP tolerance class (→ table 2) as standard • higher precision UP tolerance class (→ table 3) on request <p>BTM series bearings</p> <ul style="list-style-type: none"> • P4C tolerance class (→ table 4)

Table 2

SP class tolerances

Shaft washer and bearing height

d over	incl.	Δ_{dmp} high	low	Δ_{B1s} high	low	Δ_{T2s} high	low	$S_i^{1)}$ max.
mm		μm		μm		μm		μm
30	50	1	-11	0	-100	0	-200	3
50	80	2	-14	0	-100	0	-200	4
80	120	3	-18	0	-200	0	-400	4
120	180	3	-21	0	-250	0	-500	5
180	250	4	-26	0	-250	0	-500	5

Housing washer

D over	incl.	Δ_{Dmp} high	low	Δ_{C1s} high	low	S_e max.
mm		μm		μm		
50	80	-24	-33	0	-50	Values are identical to those for shaft washer of the same bearing.
80	120	-28	-38	0	-50	
120	150	-33	-44	0	-100	
150	180	-33	-46	0	-100	
180	250	-37	-52	0	-125	
250	315	-41	-59	0	-125	

Tolerance symbols and definitions → table 4, page 48

¹⁾ The quoted tolerances are approximate, as raceway run-out is measured in the direction of the ball load. When the bearing has been mounted, axial run-out is generally smaller than what is quoted in the table.

Table 3

UP class tolerances

Shaft washer and bearing height

d over	incl.	Δ_{dmp} high low		Δ_{B1s} high low		Δ_{T2s} high low		$S_j^{(1)}$ max.
mm		μm		μm		μm		μm
30	50	0	-8	0	-100	0	-200	1,5
50	80	0	-9	0	-100	0	-200	2
80	120	0	-10	0	-200	0	-400	2
120	180	0	-13	0	-250	0	-500	3
180	250	0	-15	0	-250	0	-500	3

Housing washer

D over	incl.	Δ_{Dmp} high low		Δ_{C1s} high low		S_e max.
mm		μm		μm		
50	80	-24	-33	0	-50	Values are identical to those for shaft washer of the same bearing.
80	120	-28	-38	0	-50	
120	150	-33	-44	0	-100	
150	180	-33	-46	0	-100	
180	250	-37	-52	0	-125	
250	315	-41	-59	0	-125	

Tolerance symbols and definitions → table 4, page 48

¹⁾ The quoted tolerances are approximate, as raceway run-out is measured in the direction of the ball load. When the bearing has been mounted, axial run-out is generally smaller than what is quoted in the table.

Table 4

P4C class tolerances

Inner ring

d over	incl.	Δ_{ds} high low		Δ_{B1s} high low		Δ_{T2s} high low		$S_j^{(1)}$ max.
mm		μm		μm		μm		μm
50	80	0	-7	0	-100	0	-200	3
80	120	0	-8	0	-200	0	-400	4
120	180	0	-10	0	-250	0	-500	4

Outer ring

D over	incl.	Δ_{Ds} high low		Δ_{C1s} high low		S_e max.
mm		μm		μm		
80	120	-28	-38	0	-100	Values are identical to those for inner ring of the same bearing.
120	150	-33	-44	0	-200	
150	180	-33	-46	0	-250	
180	250	-37	-52	0	-250	

Tolerance symbols and definitions → table 4, page 48

¹⁾ The quoted tolerances are approximate, as raceway run-out is measured in the direction of the ball load. When the bearing has been mounted, axial run-out is generally smaller than what is quoted in the table.



Preload

Double direction angular contact thrust ball bearings are manufactured so that they have a suitable operating preload when mounted.

Bearings in the BTM series are available with different preloads:

- light preload, designation suffix DBA
- heavy preload, designation suffix DBB

The preload is obtained during manufacturing by precisely adjusting the standout of the shaft washers / inner rings relative to their housing washers / outer rings. The preload values are listed in **table 5** and apply to new bearings prior to mounting. Bearing components and bearing sets must be kept together as supplied and mounted in the indicated order. For additional information, refer to *Markings on bearings* (→ **page 305**).

Effect of interference on preload

When double direction angular contact thrust ball bearings are mounted onto a shaft seat machined to the recommended $h4(\text{E})$ diameter tolerance, a transition fit, which can be either a loose or an interference fit, will result. A loose fit will not affect preload. An interference fit increases preload. For additional information, contact the SKF application engineering service.

Table 5

Axial preload for unmounted bearings

Bore diameter d	Axial preload				
	BTW	BTM .. A DBA	DBB	BTM .. B DBA	DBB
mm	N	N		N	
35	340	–	–	–	–
40	360	–	–	–	–
45	390	–	–	–	–
50	415	–	–	–	–
55	440	–	–	–	–
60	470	200	600	250	750
65	490	200	600	250	750
70	515	250	750	350	1 050
75	545	250	750	350	1 050
80	575	300	900	400	1 200
85	600	300	900	400	1 200
90	625	400	1 200	550	1 650
95	655	400	1 200	550	1 650
100	690	400	1 200	550	1 650
110	735	600	1 800	750	2 250
120	800	600	1 800	850	2 550
130	870	800	2 400	1 050	3 150
140	940	800	2 400	1 050	3 150
150	1 015	1 000	3 000	1 300	3 900
160	1 100	1 100	3 300	1 500	4 500
170	1 185	1 350	4 050	1 800	5 400
180	1 290	1 600	4 800	2 100	6 300
190	1 385	–	–	–	–
200	1 525	–	–	–	–

Axial stiffness

Axial stiffness depends on the elastic deformation (deflection) of the bearing under load and can be expressed as a ratio of load to deflection. However, since the relationship between deflection and load is not linear, only guideline values can be provided (→ **table 6**). These values apply to mounted bearings under static conditions and subjected to moderate loads. More accurate values for axial stiffness can be calculated using advanced computer methods. For additional information, contact the SKF application engineering service and refer to *Bearing stiffness* (→ **page 68**).

Table 6

Static axial stiffness

Bore diameter d	Static axial stiffness		BTM .. A/DBA		BTM .. A/DBB		BTM .. B/DBA		BTM .. B/DBB	
	with steel balls	with ceramic balls	with steel balls	with ceramic balls	with steel balls	with ceramic balls	with steel balls	with ceramic balls	with steel balls	with ceramic balls
mm	N/μm		N/μm		N/μm		N/μm		N/μm	
35	455	500	–	–	–	–	–	–	–	–
40	481	529	–	–	–	–	–	–	–	–
45	513	564	–	–	–	–	–	–	–	–
50	559	614	–	–	–	–	–	–	–	–
55	580	639	–	–	–	–	–	–	–	–
60	618	680	196	218	296	328	321	356	484	537
65	653	719	206	229	313	347	342	380	510	566
70	673	741	227	252	342	380	389	432	587	651
75	714	786	234	259	354	393	402	447	603	670
80	735	809	252	280	380	422	426	472	635	705
85	763	840	259	287	390	432	435	483	656	728
90	792	871	292	324	441	490	495	550	747	829
95	822	904	299	331	453	503	509	565	767	852
100	880	968	315	350	476	529	534	593	809	898
110	893	982	357	396	541	600	591	656	886	983
120	979	1077	377	419	571	634	649	720	985	1093
130	1032	1135	428	475	649	720	719	798	1082	1202
140	1089	1198	440	488	667	740	739	821	1113	1236
150	1125	1238	483	536	733	814	807	896	1219	1353
160	1220	1341	516	573	784	870	882	979	1331	1478
170	1225	1348	551	612	833	925	928	1030	1399	1553
180	1314	1445	597	663	902	1002	1000	1110	1504	1669
190	1361	1497	–	–	–	–	–	–	–	–
200	1395	1535	–	–	–	–	–	–	–	–

Equivalent bearing loads

Equivalent dynamic bearing load

For bearings that accommodate axial loads only:

$$P = F_a$$

Equivalent static bearing load

For bearings that accommodate axial loads only:

$$P_0 = F_a$$

Mounting

Bearing components and bearing sets must be kept together as supplied and mounted in the indicated order. For additional information, refer to *Markings on bearings* (→ page 305).

Attainable speeds

The attainable speeds listed in the product tables (→ page 312) are guideline values and are valid under certain conditions. For additional information, refer to *Attainable speeds* on page 44.

For bearings in the BTM series with a heavy preload (designation suffix DBB), the attainable speeds are 75% of the values for the same bearing with a light preload (designation suffix DBA).

Designation system

Examples: BTW 70 CTN9/SPW33
BTM 150 AM/HCP4CDBA

BTW	70	C	TN9	/		SP	W33		
BTM	150	A	M	/	HC	P4C		DB	A

Bearing series

BTW Basic design double direction angular contact thrust ball bearing
BTM High-speed design double direction angular contact thrust ball bearing

Bearing size

35 Bore diameter [mm]
to
200

Internal design

A 30° contact angle
B 40° contact angle
C 60° contact angle
A As a second letter after the contact angle information (for BTW series only): Bearing with a larger bore to be mounted on the large diameter side of a cylindrical roller bearing with a tapered bore.

Cage

M Two machined brass cages, snap-type (for BTW series), window-type (for BTM series), ball centred
TN9 Two glass fibre reinforced PA66 cages, snap-type (for BTW series), window-type (for BTM series), ball centred

Ball material

– Carbon chromium steel (no designation suffix)
HC Balls made of bearing grade silicon nitride Si₃N₄ (hybrid bearing)

Accuracy

P4C Dimensional accuracy approximately to ISO tolerance class 4 and running accuracy better than ISO tolerance class 4 for radial bearings (for BTM series bearings only).
SP Dimensional accuracy approximately to ISO tolerance class 5 and running accuracy better than ISO tolerance class 4 for thrust bearings (for BTW series bearings only).
UP Dimensional accuracy approximately to ISO tolerance class 4 and running accuracy better than ISO tolerance class 4 for thrust bearings (for BTW series bearings only).

Lubrication feature (for BTW series bearings only)

W33 Annular groove and three lubrication holes in the housing washer

Arrangement (for BTM series bearings only)

DB Two bearings arranged back-to-back

Preload (for BTM series bearings only)

A Light preload
B Heavy preload
G... Special preload, expressed in daN e.g. G240

4.1 Double direction angular contact thrust ball bearings

d 35 – 80 mm

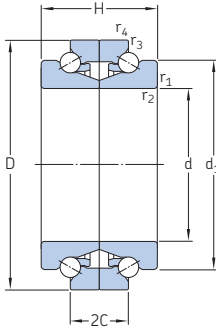

BTW

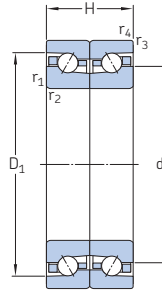

BTM

Principal dimensions			Basic load ratings		Fatigue load limit P_u	Attainable speeds ¹⁾		Mass kg	Designation
d	D	H	dynamic C	static C_0		Grease lubrication	Oil-air lubrication		
mm			kN		kN	r/min		kg	–
35	62	34	16,8	39	1,83	11 000	14 000	0,35	BTW 35 CTN9/SP
40	68	36	19,5	46,5	2,24	10 000	13 000	0,42	BTW 40 CTN9/SP
45	75	38	22,1	54	2,6	9 500	12 000	0,53	BTW 45 CTN9/SP
50	80	38	22,5	60	2,85	9 000	11 000	0,58	BTW 50 CTN9/SP
55	90	44	30,2	80	3,8	7 500	9 000	0,87	BTW 55 CTN9/SP
60	95	33	21,6	43	1,86	10 100	12 900	0,85	BTM 60 ATN9/P4CDB
	95	33	21,6	43	1,86	12 700	15 200	0,8	BTM 60 ATN9/HCP4CDB
	95	33	25	50	2,12	9 000	11 500	0,85	BTM 60 BTN9/P4CDB
	95	33	25	50	2,12	11 100	13 300	0,8	BTM 60 BTN9/HCP4CDB
	95	44	30,7	83	4	7 500	9 000	0,93	BTM 60 CTN9/SP
65	100	33	22	47,5	2	9 500	12 100	0,9	BTM 65 ATN9/P4CDB
	100	33	22	47,5	2	11 900	14 200	0,85	BTM 65 ATN9/HCP4CDB
	100	33	26	54	2,32	8 400	10 900	0,9	BTM 65 BTN9/P4CDB
	100	33	26	54	2,32	10 400	12 400	0,85	BTM 65 BTN9/HCP4CDB
	100	44	31,9	90	4,3	7 000	8 500	1	BTW 65 CTN9/SP
70	110	36	27,5	58,5	2,45	8 700	11 100	1,2	BTM 70 ATN9/P4CDB
	110	36	27,5	58,5	2,45	10 900	13 000	1,15	BTM 70 ATN9/HCP4CDB
	110	36	32	67	2,85	7 700	9 900	1,2	BTM 70 BTN9/P4CDB
	110	36	32	67	2,85	9 500	11 300	1,15	BTM 70 BTN9/HCP4CDB
	110	48	39	112	5,3	6 700	8 000	1,35	BTW 70 CTN9/SP
75	115	36	27,5	61	2,6	8 200	10 400	1,3	BTM 75 ATN9/P4CDB
	115	36	27,5	61	2,6	10 300	12 300	1,2	BTM 75 ATN9/HCP4CDB
	115	36	32,5	69,5	2,9	7 300	9 400	1,3	BTM 75 BTN9/P4CDB
	115	36	32,5	69,5	2,9	9 000	10 700	1,2	BTM 75 BTN9/HCP4CDB
	115	48	39,7	116	5,6	6 300	7 500	1,45	BTW 75 CTN9/SP
80	125	40,5	33,5	73,5	3,1	7 600	9 700	1,75	BTM 80 ATN9/P4CDB
	125	40,5	33,5	73,5	3,1	9 600	11 500	1,65	BTM 80 ATN9/HCP4CDB
	125	40,5	39	85	3,55	6 800	8 700	1,75	BTM 80 BTN9/P4CDB
	125	40,5	39	85	3,55	8 400	10 000	1,65	BTM 80 BTN9/HCP4CDB
	125	54	47,5	140	6,55	5 600	6 700	1,95	BTW 80 CTN9/SP

¹⁾ Speed values for BTM series bearings are applicable to those with a light preload (suffix DBA). For bearings with a heavy preload (suffix DBB), attainable speeds are about 75% of the quoted values.

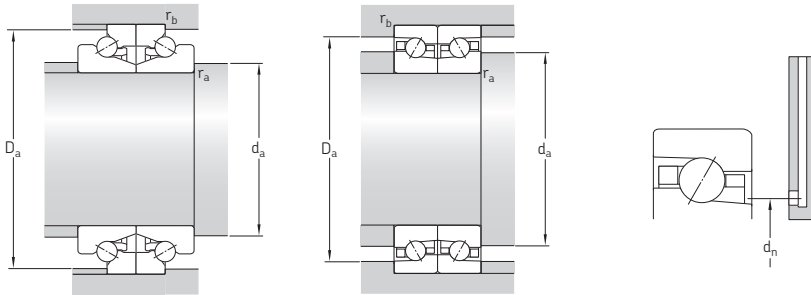

Dimensions					Abutment and fillet dimensions							Reference grease quantity ¹⁾
d	d ₁	2C	D ₁	r _{1,2} min.	r _{3,4} min.	d _a min.	D _a min.	D _a max.	r _a max.	r _b max.	d _n	G _{ref}
mm						mm						cm ³
35	50,8	17	50,2	1	0,3	45	57,3	58	1	0,3	–	1,9
40	56,4	18	55,9	1	0,3	50	63,4	64	1	0,3	–	2,5
45	62,5	19	61,9	1	0,3	56	69,9	71	1	0,3	–	3,1
50	67,5	19	66,9	1	0,3	61	74,9	76	1	0,3	–	3,3
55	75,2	22	74,4	1,1	0,6	68	84	85	1	0,6	–	4,8
60	75,9	–	81,5	1,1	0,6	66	–	91,8	1	0,6	74	7,8
	75,9	–	81,5	1,1	0,6	66	–	91,8	1	0,6	74	7,8
	75,9	–	81,5	1,1	0,6	66	–	91,8	1	0,6	74	7,8
	75,9	–	81,5	1,1	0,6	66	–	91,8	1	0,6	74	7,8
	80,2	22	79,4	1,1	0,6	73	89	90	1	0,6	–	5,2
65	80,9	–	86,5	1,1	0,6	71	–	96,8	1	0,6	79	8,4
	80,9	–	86,5	1,1	0,6	71	–	96,8	1	0,6	79	8,4
	80,9	–	86,5	1,1	0,6	71	–	96,8	1	0,6	79	8,4
	80,9	–	86,5	1,1	0,6	71	–	96,8	1	0,6	79	8,4
	85,2	22	84,4	1,1	0,6	78	94	95	1	0,6	–	5,6
70	88,55	–	94,9	1,1	0,6	76	–	106	1	0,6	86	11
	88,55	–	94,9	1,1	0,6	76	–	106	1	0,6	86	11
	88,55	–	94,9	1,1	0,6	76	–	106	1	0,6	86	11
	88,55	–	94,9	1,1	0,6	76	–	106	1	0,6	86	11
	93,5	24	92,5	1,1	0,6	85	103,4	105	1	0,6	–	7,4
75	93,55	–	99,9	1,1	0,6	81	–	111	1	0,6	91	11,8
	93,55	–	99,9	1,1	0,6	81	–	111	1	0,6	91	11,8
	93,55	–	99,9	1,1	0,6	81	–	111	1	0,6	91	11,8
	93,55	–	99,9	1,1	0,6	81	–	111	1	0,6	91	11,8
	98,5	24	97,5	1,1	0,6	90	108,4	110	1	0,6	–	7,8
80	100,8	–	107,8	1,1	0,6	86	–	121	1	0,6	98	16
	100,8	–	107,8	1,1	0,6	86	–	121	1	0,6	98	16
	100,8	–	107,8	1,1	0,6	86	–	121	1	0,6	98	16
	100,8	–	107,8	1,1	0,6	86	–	121	1	0,6	98	16
	106,2	27	105	1,1	0,6	97	117,3	119	1	0,6	–	11

¹⁾ For calculating the initial grease fill → page 101.

4.1 Double direction angular contact thrust ball bearings

d 85 – 120 mm

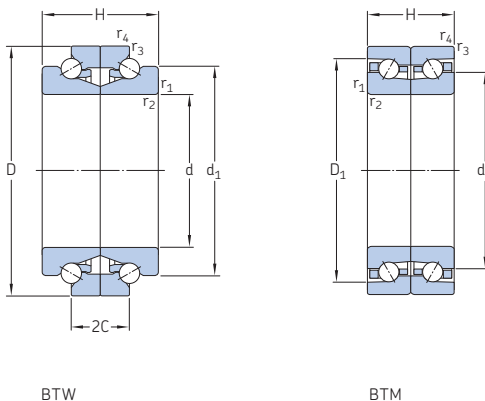

Principal dimensions			Basic load ratings		Fatigue load limit	Attainable speeds ¹⁾		Mass	Designation
d	D	H	dynamic C	static C ₀	P _u	Grease lubrication	Oil-air lubrication	kg	–
mm			kN		kN	r/min		kg	–
85	130	40,5	33,5	78	3,15	7 300	9 300	1,85	BTM 85 ATN9/P4CDB
	130	40,5	33,5	78	3,15	9 100	10 900	1,7	BTM 85 ATN9/HCP4CDB
	130	40,5	40	88	3,6	6 400	8 300	1,85	BTM 85 BTN9/P4CDB
	130	40,5	40	88	3,6	8 000	9 500	1,7	BTM 85 BTN9/HCP4CDB
	130	54	48,8	146	6,7	5 600	6 700	2,05	BTW 85 CTN9/SP
90	140	45	39	91,5	3,55	6 800	8 700	2,45	BTM 90 ATN9/P4CDB
	140	45	39	91,5	3,55	8 500	10 100	2,3	BTM 90 ATN9/HCP4CDB
	140	45	46,5	102	4	6 000	7 700	2,45	BTM 90 BTN9/P4CDB
	140	45	46,5	102	4	7 400	8 800	2,3	BTM 90 BTN9/HCP4CDB
	140	60	55,9	173	7,65	5 000	6 000	2,7	BTW 90 CTN9/SP
95	145	45	40	93	3,6	6 500	8 300	2,55	BTM 95 ATN9/P4CDB
	145	45	40	93	3,6	8 200	9 800	2,4	BTM 95 ATN9/HCP4CDB
	145	45	46,5	106	4,05	5 800	7 400	2,55	BTM 95 BTN9/P4CDB
	145	45	46,5	106	4,05	7 200	8 600	2,4	BTM 95 BTN9/HCP4CDB
	145	60	57,2	180	7,8	5 000	6 000	2,8	BTW 95 CTN9/SP
100	150	45	41,5	102	3,8	6 300	7 900	2,65	BTM 100 ATN9/P4CDB
	150	45	41,5	102	3,8	7 900	9 400	2,5	BTM 100 ATN9/HCP4CDB
	150	45	48	116	4,3	5 600	7 100	2,65	BTM 100 BTN9/P4CDB
	150	45	48	116	4,3	6 900	8 200	2,5	BTM 100 BTN9/HCP4CDB
	150	60	59,2	193	8,15	5 000	6 000	2,95	BTW 100 CTN9/SP
110	170	54	57	137	4,8	5 600	7 100	4,25	BTM 110 ATN9/P4CDB
	170	54	57	137	4,8	7 000	8 300	3,95	BTM 110 ATN9/HCP4CDB
	170	54	65,5	153	5,5	4 900	6 400	4,25	BTM 110 BTN9/P4CDB
	170	54	65,5	153	5,5	6 100	7 300	3,95	BTM 110 BTN9/HCP4CDB
	170	72	81,9	260	10,4	4 300	5 000	4,7	BTW 110 CTN9/SP
120	180	54	58,5	146	5	5 200	6 700	4,55	BTM 120 ATN9/P4CDB
	180	54	58,5	146	5	6 500	7 700	4,2	BTM 120 ATN9/HCP4CDB
	180	54	69,5	166	5,7	4 600	5 900	4,55	BTM 120 BTN9/P4CDB
	180	54	69,5	166	5,7	5 700	6 800	4,2	BTM 120 BTN9/HCP4CDB
	180	72	85,2	280	10,8	4 000	4 800	5,05	BTW 120 CTN9/SP

¹⁾ Speed values for BTM series bearings are applicable to those with a light preload (suffix DBA). For bearings with a heavy preload (suffix DBB), attainable speeds are about 75% of the quoted values.

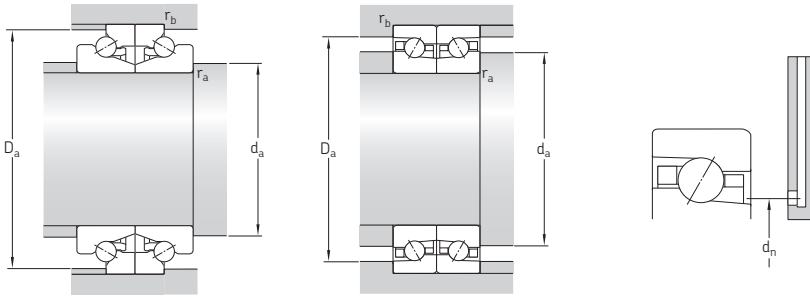

Dimensions					Abutment and fillet dimensions						Reference grease quantity ¹⁾	
d	d ₁	2C	D ₁	r _{1,2} min.	r _{3,4} min.	d _a min.	D _a min.	D _a max.	r _a max.	r _b max.	d _n	G _{ref}
mm												cm ³
85	105,8	–	112,8	1,1	0,6	91	–	126	1	0,6	103	16,8
	105,8	–	112,8	1,1	0,6	91	–	126	1	0,6	103	16,8
	105,8	–	112,8	1,1	0,6	91	–	126	1	0,6	103	16,8
	105,8	–	112,8	1,1	0,6	91	–	126	1	0,6	103	16,8
	112	27	110	1,1	0,6	102	122,3	124	1	0,6	–	11
90	113	–	120,6	1,5	1	97	–	135	1,5	1	110	22
	113	–	120,6	1,5	1	97	–	135	1,5	1	110	22
	113	–	120,6	1,5	1	97	–	135	1,5	1	110	22
	113	–	120,6	1,5	1	97	–	135	1,5	1	110	22
	119	30	117,5	1,5	0,6	109	130,9	132	1,5	0,6	–	14
95	118	–	125,6	1,5	1	102	–	140	1,5	1	115	22
	118	–	125,6	1,5	1	102	–	140	1,5	1	115	22
	118	–	125,6	1,5	1	102	–	140	1,5	1	115	22
	118	–	125,6	1,5	1	102	–	140	1,5	1	115	22
	124	30	122,5	1,5	0,6	114	135,9	137	1,5	0,6	–	15
100	123	–	130,6	1,5	1	107	–	145	1,5	1	120	22
	123	–	130,6	1,5	1	107	–	145	1,5	1	120	22
	123	–	130,6	1,5	1	107	–	145	1,5	1	120	22
	123	–	130,6	1,5	1	107	–	145	1,5	1	120	22
	129	30	127,5	1,5	0,6	119	140,9	142	1,5	0,6	–	16
110	137,9	–	147,1	2	1	119	–	165	2	1	134	38
	137,9	–	147,1	2	1	119	–	165	2	1	134	38
	137,9	–	147,1	2	1	119	–	165	2	1	134	38
	137,9	–	147,1	2	1	119	–	165	2	1	134	38
	145	36	143,1	2	1	132	159,8	161	2	1	–	27
120	147,7	–	157,1	2	1	129	–	175	2	1	144	40
	147,7	–	157,1	2	1	129	–	175	2	1	144	40
	147,7	–	157,1	2	1	129	–	175	2	1	144	40
	147,7	–	157,1	2	1	129	–	175	2	1	144	40
	155	36	153,1	2	1	142	169,8	171	2	1	–	28

¹⁾ For calculating the initial grease fill → page 101.

4.1 Double direction angular contact thrust ball bearings

d 130 – 200 mm

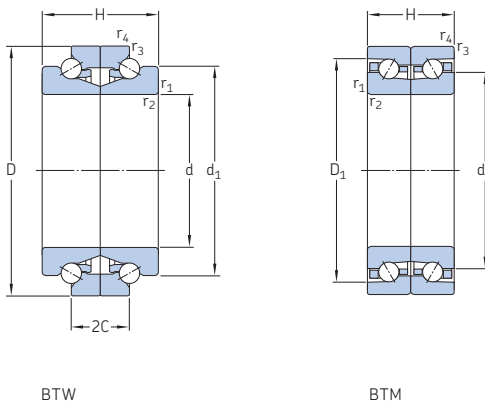

Principal dimensions			Basic load ratings		Fatigue load limit P_u	Attainable speeds ¹⁾		Mass kg	Designation
d	D	H	dynamic C	static C_0		Grease lubrication	Oil-air lubrication		
mm			kN		kN	r/min			-
130	200	63	73,5	186	6,1	4 700	6 000	6,9	BTM 130 ATN9/P4CDB
	200	63	73,5	186	6,1	5 900	7 000	6,45	BTM 130 ATN9/HCP4CDB
	200	63	85	208	6,8	4 200	5 400	6,9	BTM 130 BTN9/P4CDB
	200	63	85	208	6,8	5 100	6 100	6,45	BTM 130 BTN9/HCP4CDB
	200	84	106	360	13,2	3 600	4 300	7,6	BTW 130 CTN9/SP
140	210	63	73,5	190	6,1	4 400	5 700	7,85	BTM 140 AM/P4CDB
	210	63	73,5	190	6,1	5 600	6 700	7,4	BTM 140 AM/HCP4CDB
	210	63	86,5	216	6,95	3 900	5 100	7,85	BTM 140 BM/P4CDB
	210	63	86,5	216	6,95	4 900	5 800	7,4	BTM 140 BM/HCP4CDB
	210	84	106	375	13,2	3 200	3 800	8,6	BTW 140 CM/SP
150	225	67,5	86,5	228	7,1	4 100	5 300	9,6	BTM 150 AM/P4CDB
	225	67,5	86,5	228	7,1	5 200	6 200	9	BTM 150 AM/HCP4CDB
	225	67,5	104	260	8	3 700	4 800	9,6	BTM 150 BM/P4CDB
	225	67,5	104	260	8	4 500	5 300	9	BTM 150 BM/HCP4CDB
	225	90	127	440	15,3	3 000	3 600	10,5	BTW 150 CM/SP
160	240	72	98	260	7,8	3 900	5 000	12	BTM 160 AM/P4CDB
	240	72	98	260	7,8	4 900	5 800	11	BTM 160 AM/HCP4CDB
	240	72	114	290	8,8	3 400	4 500	12	BTM 160 BM/P4CDB
	240	72	114	290	8,8	4 300	5 100	11	BTM 160 BM/HCP4CDB
	240	96	140	510	16,6	2 800	3 400	13	BTW 160 CM/SP
170	260	81	118	315	9,15	3 600	4 700	16	BTM 170 AM/P4CDB
	260	81	118	315	9,15	4 500	5 300	15	BTM 170 AM/HCP4CDB
	260	81	140	360	10,4	3 200	4 100	16	BTM 170 BM/P4CDB
	260	81	140	360	10,4	3 900	4 600	15	BTM 170 BM/HCP4CDB
	260	108	174	610	19,6	2 400	3 000	17,5	BTW 170 CM/SP
180	280	90	140	365	10,4	3 400	4 400	21,5	BTM 180 AM/P4CDB
	280	90	140	365	10,4	4 200	5 000	20	BTM 180 AM/HCP4CDB
	280	90	163	425	11,8	3 000	3 800	21,5	BTM 180 BM/P4CDB
	280	90	163	425	11,8	3 600	4 300	20	BTM 180 BM/HCP4CDB
	280	120	199	710	22,4	2 000	2 600	23	BTW 180 CM/SP
190	290	120	203	735	22,8	2 000	2 600	24	BTW 190 CM/SP
200	310	132	238	865	25,5	1 900	2 400	31	BTW 200 CM/SP

¹⁾ Speed values for BTM series bearings are applicable to those with a light preload (suffix DBA). For bearings with a heavy preload (suffix DBB), attainable speeds are about 75% of the quoted values.

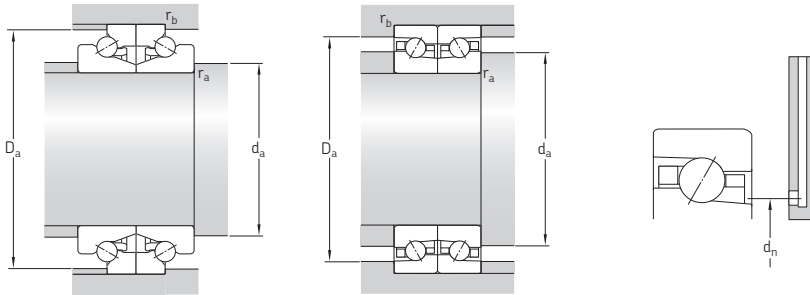

Dimensions					Abutment and fillet dimensions						Reference grease quantity ¹⁾	
d	d ₁	2C	D ₁	r _{1,2} min.	r _{3,4} min.	d _a min.	D _a min.	D _a max.	r _a max.	r _b max.	d _n	G _{ref}
mm												cm ³
130	162,6	–	173,3	2	1	139	–	195	2	1	158	58
	162,6	–	173,3	2	1	139	–	195	2	1	158	58
	162,6	–	173,3	2	1	139	–	195	2	1	158	58
	162,6	–	173,3	2	1	139	–	195	2	1	158	58
	171	42	168,6	2	1	156	187,5	190	2	1	–	40
140	172,6	–	183,3	2,1	1	151	–	205	2	1	168	62
	172,6	–	183,3	2,1	1	151	–	205	2	1	168	62
	172,6	–	183,3	2,1	1	151	–	205	2	1	168	62
	172,6	–	183,3	2,1	1	151	–	205	2	1	168	62
	181	42	178,6	2,1	1	166	197,7	200	2	1	–	45
150	184,9	–	196,4	2,1	1,1	161	–	219	2	1	180	80
	184,9	–	196,4	2,1	1,1	161	–	219	2	1	180	80
	184,9	–	196,4	2,1	1,1	161	–	219	2	1	180	80
	184,9	–	196,4	2,1	1,1	161	–	219	2	1	180	80
	194	45	191,2	2,1	1	178	212,4	213	2	1	–	56
160	196,8	–	209,2	2,1	1,1	171	–	234	2	1	192	94
	196,8	–	209,2	2,1	1,1	171	–	234	2	1	192	94
	196,8	–	209,2	2,1	1,1	171	–	234	2	1	192	94
	196,8	–	209,2	2,1	1,1	171	–	234	2	1	192	94
	207	48	203,7	2,1	1	190	226	227	2	1	–	67
170	211,3	–	225,6	2,1	1,1	181	–	254	2	1	205	126
	211,3	–	225,6	2,1	1,1	181	–	254	2	1	205	126
	211,3	–	225,6	2,1	1,1	181	–	254	2	1	205	126
	211,3	–	225,6	2,1	1,1	181	–	254	2	1	205	126
	223	54	219,3	2,1	1	204	244,9	246	2	1	–	90
180	226,5	–	241,7	2,1	1,1	191	–	274	2	1	220	160
	226,5	–	241,7	2,1	1,1	191	–	274	2	1	220	160
	226,5	–	241,7	2,1	1,1	191	–	274	2	1	220	160
	226,5	–	241,7	2,1	1,1	191	–	274	2	1	220	160
	239	60	234,8	2,1	1	214	262,6	264	2	1	–	117
190	249	60	244,8	2,1	1	224	272,6	274	2	1	–	122
200	264	66	259,9	2,1	1	236	291	292	2	1	–	157

¹⁾ For calculating the initial grease fill → page 101.

Super-precision bearing

SKF

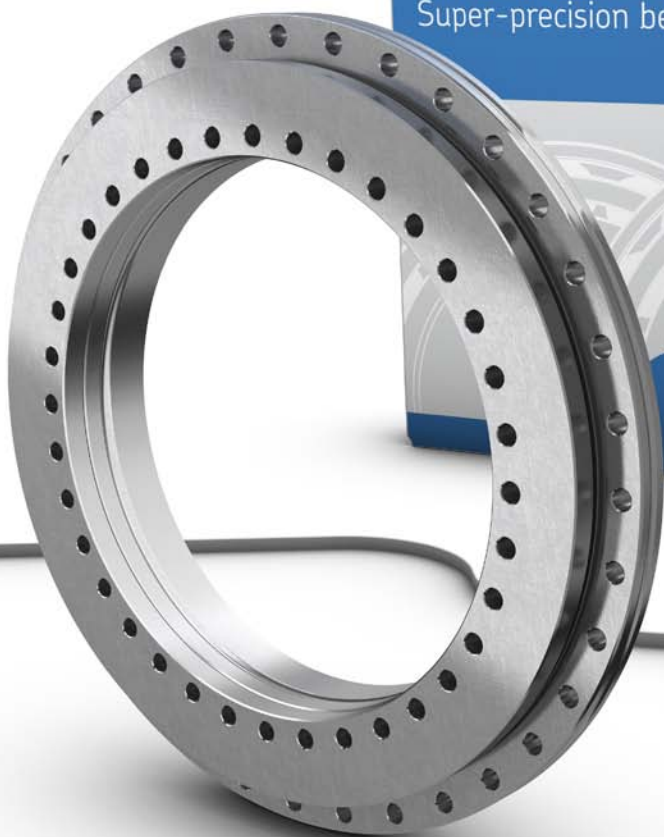

Axial-radial cylindrical roller bearings

Designs and variants	320	Product table	
Bearing data	321	5.1 Axial-radial cylindrical roller bearings	334
(Boundary dimensions, tolerances)			
Preload and stiffness	322		
Friction	322		
Lubrication	324		
Design considerations	324		
Load carrying capacity	327		
Equivalent bearing loads	327		
Permissible moment load	328		
Mounting	330		
Designation system	333		

More information

Bearing life and load ratings	33
Requisite minimum load	34
Chamfer dimension limits	47
Materials	51
Design considerations	57
Lubrication	99
Mounting and dismounting	123
Bearing storage	125

Super-precision axial-radial cylindrical roller bearings are commonly used to support rotary tables, indexing heads and multi-spindle heads on machining centres. SKF manufactures super-precision axial-radial cylindrical roller bearings for shaft diameters from 80 to 850 mm. Their internal design, together with close tolerance manufacturing processes, enables these bearings to attain radial run-out better than, and axial run-out close to, P4 tolerance class.

Designs and variants

Axial-radial cylindrical roller bearings can accommodate radial loads, axial loads in both directions and moment loads, whether acting singly, or simultaneously, in any combination.

These bearings consist of (→ **fig. 1**):

- Two roller and cage thrust assemblies and a full complement radial roller set.
- An inner ring which has an L-shaped cross section and two raceways. One raceway accommodates the roller and cage thrust assembly and the other accommodates the full complement radial roller set. The inner ring is drilled for attachment bolts.
- A loose flange which acts as a raceway to accommodate the second roller and cage thrust assembly. The flange is held in place to the inner ring with transport bolts that should not be removed until after the bearing has been mounted. The flange is drilled for attachment bolts.
- An outer ring which has three raceways to accommodate both roller and cage thrust assemblies and the full complement radial roller set.

The bearings are supplied standard without grease (no designation suffix) but can also be supplied greased (designation suffix G).

Bearings supplied without grease must be adequately lubricated with either grease or oil through the lubrication holes in the bearing rings. Bearings, greased at the factory, are filled with a grease that is suitable for most applications over the normal speed range for the bearing.

Fig. 1

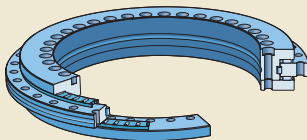

Bearing data

Boundary dimensions

Not standardized

Tolerances

For additional information
(→ page 47)

- manufactured to the tolerances listed in **table 1**
- improved radial and axial run-out (50% tighter) on request

Table 1

Tolerances for axial-radial cylindrical roller bearings

Inner ring

d over	incl.	Δ_{ds} high	low	V_{dp} max.	V_{dmp} max.	Δ_{Hs} high	low	Δ_{H1s} high	low	K_{ia} max.	S_i max.
mm		μm		μm	μm	μm		μm		μm	μm
50	80	0	-9	5	3,5	0	-175	25	-25	3	3
80	120	0	-10	6	4	0	-175	25	-25	3	3
120	150	0	-13	8	5	0	-175	30	-30	3	3
150	180	0	-13	8	5	0	-175	30	-30	4	4
180	250	0	-15	9	6	0	-200	30	-30	4	4
250	315	0	-18	11	8	0	-400	40	-40	6	6
315	400	0	-23	14	10	0	-400	50	-50	6	6
400	500	0	-27	17	12	0	-450	60	-60	6	6
500	630	0	-33	20	14	0	-500	75	-75	10	10
630	800	0	-40	24	16	0	-700	100	-100	10	10
800	1000	0	-50	30	20	0	-850	120	-120	12	12

Outer ring

D over	incl.	Δ_{Ds} high	low	V_{Dp} max.	V_{Dmp} max.	K_{ea} max.	S_e max.
mm		μm		μm	μm		
120	150	0	-11	7	5		
150	180	0	-13	8	5		
180	250	0	-15	8	6		
250	315	0	-18	10	7		
315	400	0	-20	11	8		
400	500	0	-23	14	9		
500	630	0	-28	17	11		
630	800	0	-35	20	13		
800	1000	0	-45	26	17		
1000	1250	0	-55	34	20		

Values are identical to those for inner ring of the same bearing.

Tolerance symbols and definitions → table 4, page 48

Preload and stiffness

Due to the large number of cylindrical rollers in each of the rows, with line contact between them and the raceways, there is a minimal amount of elastic deformation in the bearing under load from any direction.

To provide maximum stiffness the rollers are calibrated during assembly so that a preload is achieved in each row once mounting is complete. Appropriate preload extends bearing service life, improves rigidity and running accuracy, while reducing noise levels.

As a result of the closely controlled preload, stiffness in any direction can be considered constant.

In cases where a heavy axial load acts on an axial-radial cylindrical roller bearing, the loaded roller set can deflect and reduce the preload on the second thrust roller set. In severe cases, the second thrust roller set can become completely unloaded, which can cause the rollers to skid and damage the raceways or subject the cage to impermissible stresses. For additional information, contact the SKF application engineering service.

Preload for the thrust roller sets and stiffness values, together with the axial unloading force, are listed in **table 2**. They are valid for bearings mounted properly and attachment bolts tightened to the recommended torque values (→ **table 7, page 332**).

Friction

The frictional losses in axial-radial cylindrical roller bearings, as with other rolling bearings, depend on different factors. For general information, refer to *Friction* (→ **page 37**).

The values for the frictional moment listed in **table 3** were measured in functional tests and are average values. They should be used as guideline values only. The tests were conducted under the following operating conditions:

- lubrication: grease, kinematic viscosity 150 mm²/s at 40 °C (105 °F)
- rotational speed: 5 r/min
- ambient temperature: 30 to 40 °C (85 to 105 °F)
- attachment bolts tightened to the recommended torque values (→ **table 7, page 332**)

Table 2

Preload and stiffness

Bearing	Axial preload ¹⁾	Axial unloading force ¹⁾	Axial stiffness ²⁾	Radial stiffness ²⁾	Moment stiffness ²⁾
–	kN	kN	kN/μm	kN/μm	kNm/mrad
NRT 80 A	1,3	2,8	4,9	3,1	7
NRT 100 A	1,7	3,8	7,2	3,7	15
NRT 120 A	1,9	4,3	8,1	4,5	22
NRT 150 A	2,2	4,8	9	5,5	35
NRT 180 A	2,5	5,5	10,3	5,8	53
NRT 200 A	2,8	6,2	11,6	6,5	73
NRT 260 A	7,2	16	14,5	8,3	150
NRT 325 A	12	26	28,6	8,9	413
NRT 395 A	14	30	33,6	10,6	672
NRT 460 A	16	34	38,5	12,1	1036
NRT 580 A	25	55	43,5	18,6	1838
NRT 650 A	27	59	60	17,2	3209
NRT 850 A	47	103	77	22,4	7011

¹⁾ These values are averages.

²⁾ Stiffness values refer to the roller set.

Table 3

Frictional moment

Bearing	Frictional moment C_{RL}
–	Nm
NRT 80 A	3
NRT 100 A	3
NRT 120 A	6
NRT 150 A	12
NRT 180 A	13
NRT 200 A	14
NRT 260 A	25
NRT 325 A	45
NRT 395 A	55
NRT 460 A	70
NRT 580 A	140
NRT 650 A	200
NRT 850 A	300

Guideline values only

Lubrication

The choice of whether to use grease or oil should be based on the speed and operating temperature of the application. Axial-radial cylindrical roller bearings are typically lubricated by an oil bath or circulating oil system. Grease is normally reserved for lower speed and lower temperature applications.

Grease or oil can be introduced into the bearing via the lubrication holes in the bearing rings. Note that if the bearing is over-lubricated, excessive frictional heat increases bearing operating temperature.

The technical specifications of the standard grease in greased axial-radial cylindrical roller bearings (designation suffix G) are listed in **table 4**.

To achieve the lowest frictional moment and temperature, axial-radial cylindrical roller bearings need to be properly run-in. A typical running-in procedure consists of rotating the bearing for one hour at different speed steps, starting from an initial value of ~ 15% of the maximum operating speed and increasing by steps of 10% each time. During running-in, the bearing operating temperature should not exceed 70 °C (160 °F).

Table 4

Technical specifications of the standard grease in greased bearings (designation suffix G)

Properties	Grease specification
Thickener	Lithium complex soap
Base oil type	Mineral
NLGI consistency class	2
Temperature range [°C] [°F]	-30 to +140 -20 to +285
Kinematic viscosity [mm ² /s] at 40 °C (105 °F) at 100 °C (210 °F)	185 15

Design considerations

Recommended shaft and housing fits

Shaft and housing seats for super-precision axial-radial cylindrical roller bearings should be manufactured to the following tolerance classes:

- h5 (E) for the shaft (→ **table 5**)
- J6 (E) for the housing bore (→ **table 6**, **page 326**)

Accuracy of seats and abutments

If a super-precision axial-radial cylindrical roller bearing is to obtain a high degree of running accuracy and low operating temperature, its associated components must be manufactured to similar levels of precision.

Recommendations for the geometrical tolerances and surface roughness are provided in:

- **table 5** for the shaft
- **table 6, page 326** for the housing

The recommended shaft and housing diameter tolerances, relative to the bearing bore and outside diameter tolerances result in a transition fit, tending towards clearance. In some cases, however, an interference fit may result for either the bearing inner or outer ring. When this occurs, preload on the radial roller set will increase, as will contact stresses, friction and frictional heat.

To optimize operating conditions and running accuracy in applications where there is inner ring rotation, the fit between the shaft and inner ring should be a loose fit that is as close to zero as possible. A near-zero loose fit should be applied to the outer ring and housing when the outer ring rotates.

To help obtain a near-zero loose fit on a shaft, SKF supplies axial-radial cylindrical roller bearings with an inspection report. The report includes the measured deviation from nominal of the inner ring bore diameter. It also includes the measured deviation from nominal of the bearing height and measured running accuracy.

Table 5

Geometrical accuracy for bearing shaft seats

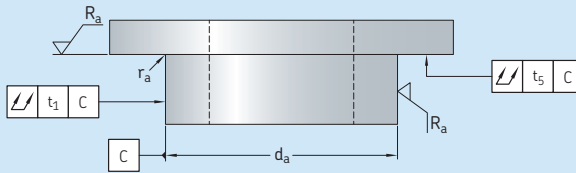

Shaft diameter		Tolerance			Total radial run-out	Total axial run-out	Surface roughness
d_a over	incl.	$h5^{\text{E}}$ high	low	r_a max.	t_1 max.	t_5 max.	R_a max.
mm		μm		mm	μm	μm	μm
50	80	0	-13	0,2	3	3	0,8
80	120	0	-15	0,2	4	4	0,8
120	150	0	-18	0,2	5	5	0,8
150	180	0	-18	0,2	5	5	0,8
180	250	0	-20	0,2	7	7	0,8
250	315	0	-23	0,5	8	8	0,8
315	400	0	-25	0,5	9	9	0,8
400	500	0	-27	0,9	10	10	0,8
500	630	0	-32	0,9	11	11	0,8
630	800	0	-36	1,3	13	13	0,8
800	1 000	0	-40	1,3	15	15	0,8

Surface roughness R_a in accordance with ISO 1302

Attachment bolt holes

Axial-radial cylindrical roller bearings require threaded holes for attachment bolts in the shaft and housing. Details about spacing and thread sizes are listed in the product table (\rightarrow page 334). At the position of retaining bolts and removal threads, no attachment bolt holes are required.

Bearing NRT 80 A should be fixed with 12 attachment bolts each in the inner and outer ring. For this bearing, the retaining bolts and removal threads are positioned between the attachment bolt holes, evenly spaced at 120° .

Geometrical accuracy for bearing housing seats

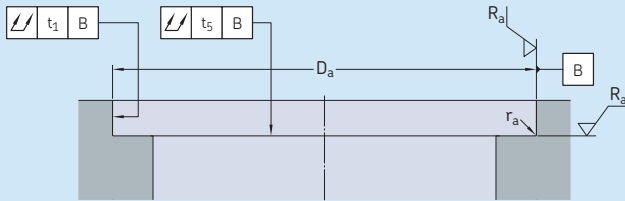

Housing diameter		Tolerance			Total radial run-out	Total axial run-out	Surface roughness
D_a over	incl.	J6(Ⓔ) high	low	r_a max.	t_1 max.	t_5 max.	R_a max.
mm		μm		mm	μm	μm	μm
120	150	18	-7	0,2	5	5	0,8
150	180	18	-7	0,5	5	5	0,8
180	250	22	-7	0,5	7	7	0,8
250	315	25	-7	0,5	8	8	0,8
315	400	29	-7	0,5	9	9	0,8
400	500	33	-7	0,5	10	10	0,8
500	630	34	-10	0,9	11	11	0,8
630	800	38	-12	0,9	13	13	0,8
800	1 000	44	-12	0,9	15	15	0,8
1 000	1 250	52	-14	1,3	18	18	0,8

Surface roughness R_a in accordance with ISO 1302

Load carrying capacity

Axial-radial cylindrical roller bearings can accommodate radial loads, axial loads in both directions and moment loads, whether acting singly, or simultaneously, in any combination. As the bearing is preloaded and normally used to support axial and radial loads acting offset from, or eccentrically to, the bearing axis, the evaluation of the equivalent bearing loads by manual methods can only be approximated. Equivalent bearing loads in the radial and axial directions should be calculated separately. From these, the life ratings can be calculated for each row of rollers. If a more accurate bearing load analysis and calculation for rated life are required, contact the SKF application engineering service.

Basic load ratings are listed in the product table (→ **page 334**).

Equivalent bearing loads

The equivalent dynamic bearing load can be calculated:

- for the radial roller set using $P = F_r$
- for the thrust roller set using $P = F_a + 4,4 M/d_1$

The equivalent static bearing load can be calculated:

- for the radial roller set using $P_0 = F_r$
- for the thrust roller set using $P_0 = F_a + 4,4 M/d_1$

where

P = equivalent dynamic bearing load [kN]

P_0 = equivalent static bearing load [kN]

d_1 = outside diameter of inner ring [mm]

(→ **product table, page 334**)

F_a = axial load [kN]

F_r = radial load [kN]

M = moment load [kNmm]

Permissible moment load

Axial-radial cylindrical roller bearings generally rotate slowly, perform slow slewing movements, or are subjected to load when stationary. Under these conditions, the maximum permissible moment load is limited by the static load limit and can be determined using

$$M_{\text{perm}} = 0,23 d_1 (C_{0a}/s_0 - F_a)$$

where

M_{perm} = permissible moment [kNmm]

C_{0a} = basic static load rating of thrust roller set [kN] (→ **product table, page 334**)

d_1 = outside diameter of inner ring [mm] (→ **product table**)

F_a = centrally acting axial load [kN]

s_0 = safety factor (→ *Permissible static loads, page 36*)
= 4

If frequent rotation or oscillation apply, rating life may limit the permissible moment load. In these cases, contact the SKF application engineering service.

Diagram 1 can be used for a quick check of the suitability of the selected bearing size under predominantly static loads.

Diagram 1

Permissible moment load – static limiting load

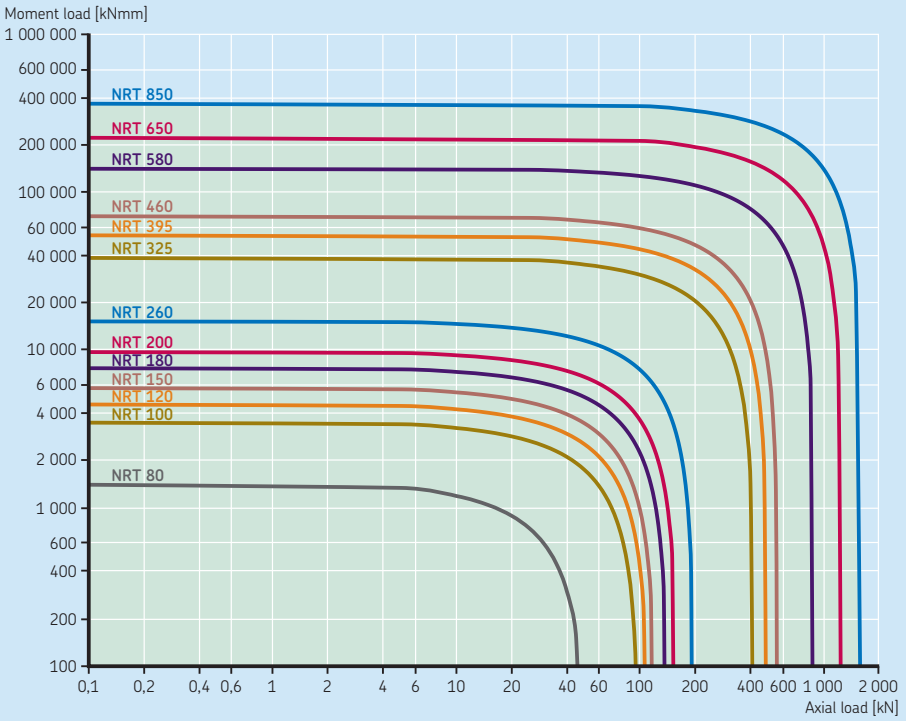

5

Mounting

Axial-radial cylindrical roller bearings are precision machine elements that can provide long service life, provided they are mounted and maintained properly. Proper mounting requires experience, accuracy, a clean work environment and the appropriate tools.

Mounting instructions

For general information about mounting bearings, refer to *Mounting and dismounting* (→ page 123).

When mounting axial-radial cylindrical roller bearings the inner ring can be unsupported (→ fig. 2) or supported (→ fig. 3). When a support ring is used, it should support the inner ring over its entire width. The support ring should be approximately twice the thickness of the flange.

CAUTION: To reduce the risk of damaging the bearing, do not apply any force through the rolling elements. Force should only be applied directly through the ring that is being mounted.

Mounting procedure

- 1 Coat all mating surfaces on the shaft and inner ring with a thin layer of light oil.
- 2 Loosen the retaining bolts (used to secure the bearing during transportation) 1/2 a turn.
- 3 Mount the bearing onto the shaft, loose flange first, aligning the attachment bolt holes in the bearing with the tapped holes in the shaft. To facilitate this process, an induction heater can be used and/or a guide stud can be inserted into one of the attachment bolt holes in the shaft. SKF does not recommend heating axial-radial cylindrical roller bearings above 80 °C (175 °F).
- 4 Once the bearing (and support ring where applicable) is in position against the shaft abutment and the assembly is at ambient temperature, insert the attachment bolts and tighten them "finger tight" while rotating the outer ring. This procedure helps to settle the rollers and centre the inner ring assembly.

- 5 With the inner ring centred, gradually tighten each attachment bolt in a criss-cross pattern in three stages (→ fig. 4), tightening the bolts to 35%, then 70% and then 100% of the recommended torque values listed in table 7 (→ page 332).
- 6 After the bearing is fitted, the retaining bolts must not be left loose. Either retighten them to the recommended torque values or remove them completely.
- 7 A similar procedure can be applied for fitting the outer ring. Coat all mating surfaces in the housing and on the outer ring with a thin layer of light oil.
- 8 Mount the bearing/shaft assembly into the housing (→ fig. 5).
- 9 Insert and tighten the attachment bolts "finger tight" while rotating the bearing/shaft assembly. Tighten each attachment bolt in a criss-cross pattern in three stages (→ fig. 6), as described in step 5.

Checking running accuracy and friction

Once mounting is complete, the running accuracy and friction need to be checked. In cases where friction is particularly high, there are three potential explanations:

- The mating parts are not machined according to specification.
- The attachment bolts are over-tightened.
- There is too much grease in the bearing.

To eliminate possible stresses that may have occurred during mounting, loosen all attachment bolts and retighten them in a criss-cross pattern using the three stage process described above.

Storage/Transport

Axial-radial cylindrical roller bearings should always be stored flat.

Fig. 2

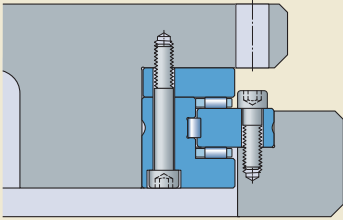

Fig. 3

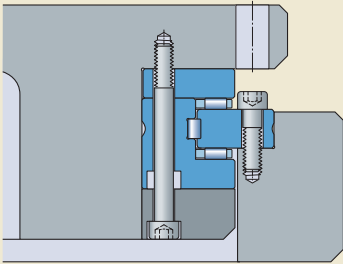

Fig. 4

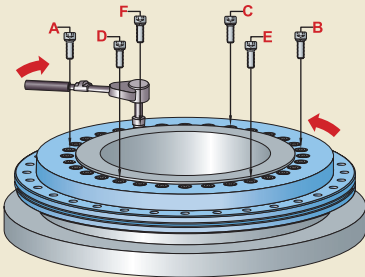

Fig. 5

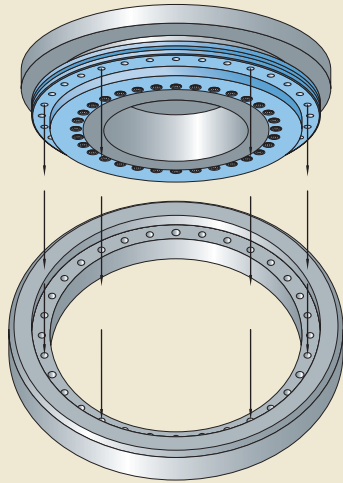
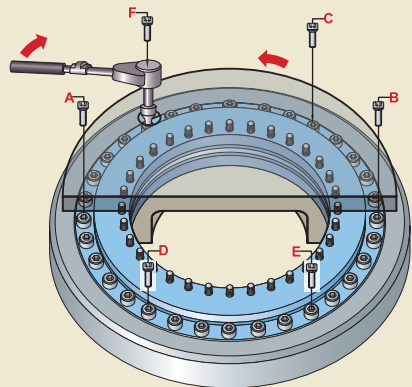

Fig. 6



Axial-radial cylindrical roller bearings

Table 7

Recommended bolt tightening torque

Bearing	Tightening torque	Bolt size quality 10,9
–	Nm	–
NRT 80 A	4,5 8,5	M4 M5
NRT 100 A	8,5	M5
NRT 120 A	14	M6
NRT 150 A	14	M6
NRT 180 A	14	M6
NRT 200 A	14	M6
NRT 260 A	34	M8
NRT 325 A	34	M8
NRT 395 A	34	M8
NRT 460 A	34	M8
NRT 580 A	68	M10
NRT 650 A	116	M12
NRT 850 A	284	M16

Do not use a higher torque value which could increase the bearing preload.

Designation system

Example: NRT 260 A/G

NRT	260	A	/	G
-----	-----	---	---	---

Bearing series

NRT Axial-radial cylindrical roller bearing

Bearing size

80 Bore diameter [mm]
to
850

Internal design

A Basic internal design
B Modified internal design

Other features

G Bearing greased at the factory

5.1 Axial-radial cylindrical roller bearings

d 80 – 850 mm

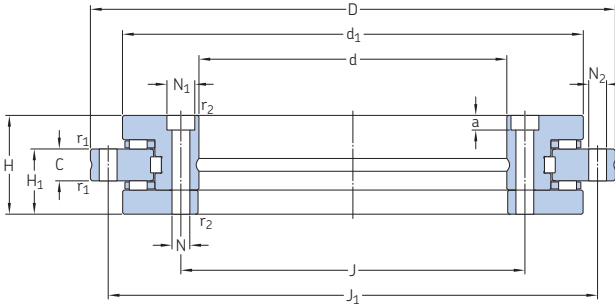

Principal dimensions					Basic load ratings					Attainable speeds		Mass	Suit-able rotary table	Designa-tion		
d ¹⁾	D	H	H ₁	C	d ₁	r ₁ min.	r ₂ min.	radial dynamic C	static C ₀	axial dynamic C	static C ₀	Grease lubri- cation	Oil lubri- cation	kg	mm	-
mm								kN				r/min				
80	146	35	23,35	12	130	0,3	0,3	55	102	37,5	200	350	700	2,4	200	NRT 80 A
100	185	38	25	12	160	0,6	0,3	58,3	116	68	390	280	560	4,1	260	NRT 100 A
120	210	40	26	12	184	0,6	0,3	64,4	140	72	440	230	460	5,3	315	NRT 120 A
150	240	40	26	12	214	0,6	0,3	67,1	160	75	480	210	420	6,2	350	NRT 150 A
180	280	43	29	15	244	0,6	0,3	89,7	236	80	560	190	380	7,7	400	NRT 180 A
200	300	45	30	15	274	0,6	0,3	93,5	270	85	630	170	340	9,7	500	NRT 200 A
260	385	55	36,5	18	345	0,6	0,6	108	355	95	780	130	260	18,5	630	NRT 260 A
325	450	60	40	20	415	0,6	0,6	134	450	153	1 660	110	220	25	700	NRT 325 A
395	525	65	42,5	20	486	1	1	147	530	166	1 960	90	180	33	800	NRT 395 A
460	600	70	46	22	560	1	1	201	765	180	2 240	80	160	45	1 000	NRT 460 A
580	750	90	60	30	700	1	1	229	965	285	3 550	60	120	89	1 250	NRT 580 A
650	870	122	78	34	800	1	1	413	1 600	365	5 000	55	110	170	1 450	NRT 650 A
850	1 095	124	80,5	37	1 018	1,5	1,5	473	2 120	415	6 400	40	80	253	1 800	NRT 850 A

¹⁾ Different shaft diameters can be supplied on request. Contact your local SKF representative.

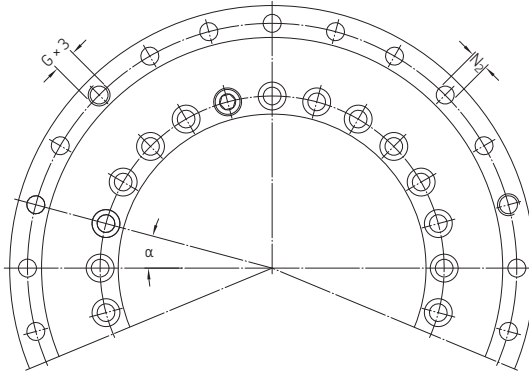

Attachment holes Inner ring				Outer ring				Pitch		Retaining bolts ¹⁾		
J	N	N ₁	a	Attachment holes nr.	J ₁	N ₂	Attachment holes nr.	Removal thread G	Removal thread nr.	nr. x α [°]	Size	nr.
mm				-	mm		-			-	-	
92	5,6	10 ²⁾	4	12	138	4,6	12	M5	3	12x30	M5	3
112	5,6	10	5,4	16	170	5,6	15	M5	3	18x20	M5	2
135	7	11	6,2	22	195	7	21	M8	3	24x15	M6	2
165	7	11	6,2	34	225	7	33	M8	3	36x10	M6	2
194	7	11	6,2	46	260	7	45	M8	3	48x7,5	M6	2
215	7	11	6,2	46	285	7	45	M8	3	48x7,5	M6	2
280	9,3	15	8,2	34	365	9,3	33	M12	3	36x10	M8	2
342	9,3	15 ²⁾	8,2	34	430	9,3	33	M12	3	36x10	M8	2
415	9,3	15	8,2	46	505	9,3	45	M12	3	48x7,5	M8	2
482	9,3	15	8,2	46	580	9,3	45	M12	3	48x7,5	M8	2
610	11,4	18	11	46	720	11,4	42	M12	6	48x7,5	M10	2
680	14	20	13	46	830	14	42	M12	6	48x7,5	M12	2
890	18	26	17	58	1055	18	54	M16	6	60x6	M16	2

¹⁾ Retaining bolts are screwed into the loose flange.

²⁾ Milled slots open towards bearing bore.

Super-precision bearing

SKF



Angular contact thrust ball bearings for screw drives

Designs and variants	338	Axial load carrying capacity	362
Single direction angular contact thrust ball bearings	340	Mounting	362
Double direction angular contact thrust ball bearings	341	Attainable speeds	363
Cartridge units with a flanged housing	342	Designation system	364
Customized solutions	342	Product tables	
Cages	344	6.1 Single direction angular contact thrust ball bearings	366
Sealing solutions	344	6.2 Double direction angular contact thrust ball bearings	368
Bearing arrangement design	346	6.3 Double direction angular contact thrust ball bearings for bolt mounting	370
Bearing arrangements	346	6.4 Cartridge units with a flanged housing	372
Bearings for the non-locating position	347		
Associated components	349		
Application examples	350		
Markings on bearings	352		
Bearing data	353		
(Boundary dimensions, tolerances)			
Bearing preload	355		
Axial stiffness	358		
Frictional moment	360		
Lifting force	360		
Load carrying capacity of bearing sets	361		
Equivalent bearing loads	361		
Equivalent dynamic bearing load	361		
Equivalent static bearing load	362		

More information

Bearing life and load ratings	33
Requisite minimum load	34
Chamfer dimension limits	47
Materials	51
Design considerations	57
Lubrication	99
Mounting and dismounting	123
Bearing storage	125
Precision lock nuts	375

Machine tools require screw drives that can position a work piece or machine component quickly, efficiently, and precisely. To meet these requirements, screw drives can be supported at both ends by SKF super-precision angular contact thrust ball bearings. The bearings provide a high degree of axial stiffness, high axial load carrying capacity, accommodate high speeds and rapid accelerations, and offer very high running accuracy.

Angular contact thrust ball bearings for screw drives are well suited for screw drive applications, but are also beneficial in other applications, where safe radial and axial support is required, together with extremely precise axial guidance of the shaft.

Designs and variants

The SKF assortment of super-precision angular contact thrust ball bearings for screw drives can accommodate virtually any requirement placed on support bearings for screw drives. SKF supplies three types of support bearings:

- single direction bearings
- double direction bearings
- cartridge units with a flanged housing

The main criteria used when selecting bearings to support screw drives are axial stiffness and load carrying capacity, running accuracy, speed, and frictional moment. Other factors to consider can be the moment stiffness of a bearing arrangement or the ability to cope with misalignment between the shaft and housing. Mounting and seal requirements also need to be considered. **Table 1** provides an overview of the criteria and to what extent the different bearing series fulfil the requirements.

Table 1

Selection criteria for angular contact thrust ball bearings for screw drives

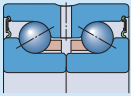
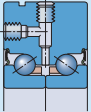
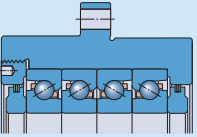
Bearing type	Single direction bearings	Double direction bearings	Double direction bearings for bolt mounting	Cartridge units
				
Bearing series	BSA, BSD	BEAS	BEAM	FBSA

Selection criteria

Axial stiffness	++	+	+	++
Axial load carrying capacity	++	++	++	++
Running accuracy	++	++	++	++
Speed capability	++	+	+	+
Frictional moment	++	+	+	++
Flexibility in arrangement	+	o	o	++
Easy mounting	o	+	++	++
Seals	non-contact seals (optional)	contact or non-contact seals	contact or non-contact seals	laminar rings

Symbols: ++ very good + good o suitable

Single direction angular contact thrust ball bearings

SKF supplies single direction angular contact thrust ball bearings (→ **fig. 1**) in the BSA and BSD series for shaft diameters from 12 to 75 mm. The bearings are non-separable and have a 62° contact angle. The transition radius between the raceway and shoulder on both rings is ground. This reduces edge stresses by approximately 30%, enabling these bearings to accommodate heavy axial loads and incidental overloading better than conventional designs.

Single direction bearings are designed to accommodate axial loads in one direction only and are therefore adjusted against a second bearing or mounted as sets. The bearings are universally matchable, as standard, and can be mounted in sets of up to four bearings for a variety of bearing arrangements, reaching the performance level of matched sets. A unique heat treatment helps to maintain a constant bearing preload over the entire service life of the bearings.

Matched bearing sets

Single direction bearings can be supplied as matched sets on request. However, because the standard bearings are universally matchable, SKF recommends reducing inventory by ordering single bearings only and arranging them in sets as required.

Fig. 1

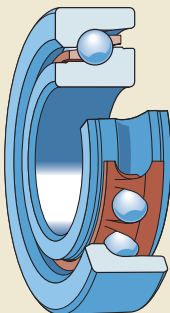

Double direction angular contact thrust ball bearings

Double direction angular contact thrust ball bearings were developed for applications where space is limited and easy mounting is required. SKF double direction bearings are greased and sealed as standard. These ready-to-mount bearings are available in two series:

- double direction bearings in the BEAS series (→ **fig. 2**), for shaft diameters from 8 to 30 mm
- double direction bearings for bolt mounting in the BEAM series (→ **fig. 3**), for shaft diameters from 12 to 60 mm

BEAS series

Bearings in the BEAS series correspond in design to two single direction bearings arranged back-to-back. They are non-separable and have a one-piece outer ring, a two-piece inner ring, and a 60° contact angle. The bearings accommodate radial loads, and axial loads in both directions. Preload (which is preset at the factory) is applied by clamping the inner ring halves on the screw drive shaft with, for example, a precision lock nut (→ *Precision lock nuts*, **page 375**).

BEAS bearings have an annular groove and lubrication holes in the outer ring as standard to relubricate the bearing easily and reliably when necessary.

BEAM series

Bearings in the BEAM series correspond in design to BEAS series bearings except that the outer ring is much thicker and equipped with through holes for attachment bolts. By bolting directly onto an associated component, the design and mounting process is simplified. To enable relubrication, if required, one side face and the bearing outside surface have M6 threaded holes for grease fittings. The holes are plugged on delivery with grub (set) screws. The side face with the threaded hole should be mounted opposite the machine wall. Bearings manufactured to larger tolerances (designation suffix PE) do not have a threaded hole on the outside surface of the bearing and can only be relubricated via the threaded hole in the side face.

BEAM bearings have an annular groove on their outside surface that can be used to dismount the bearing from its seat on the screw drive shaft.

Fig. 2

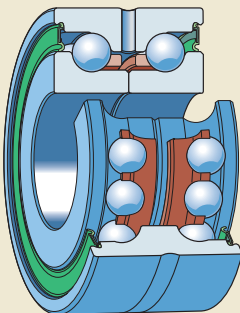
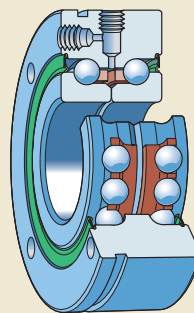

Fig. 3



Cartridge units with a flanged housing

Cartridge units in the FBSA series (→ **fig. 4**) have a flanged housing to enable quick and easy mounting. These ready-to-mount units are available for shaft diameters ranging from 20 to 60 mm and incorporate SKF single direction angular contact thrust ball bearings (→ **page 340**). Except for the ground surfaces, the units are surface-treated with a black-oxide finish.

The units are available with different bearing arrangements (→ **fig. 5**):

- two bearings arranged back-to-back, designation suffix DB
- two bearings arranged face-to-face, designation suffix DF
- two bearing pairs arranged tandem back-to-back, designation suffix QBC
- two bearing pairs arranged tandem face-to-face, designation suffix QFC

Units with two bearing pairs are also available with the flange at the end of the cartridge (designation suffix A). Other bearing arrangements are available on request.

Cartridge units should be bolted to the machine wall and located on the screw drive shaft with an SKF precision lock nut (→ **page 375**).

Customized solutions

The SKF assortment of support bearings covers a wide variety of application conditions. SKF can also provide customized solutions for specific applications. Advanced modelling and virtual testing services enable SKF engineers to assist in all stages of product development. For additional information, contact the SKF application engineering service.

Greased bearings

Open, single direction bearings can be supplied greased on request, with the standard grease used for sealed bearings (designation suffix GMM, → *Sealing solutions*, **page 344**).

Customer-specific greases or fill quantities can also be applied to meet the requirements of a specific application.

Fig. 4

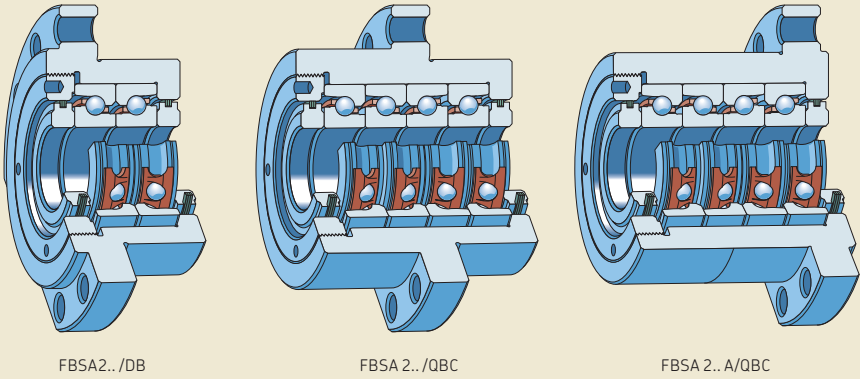
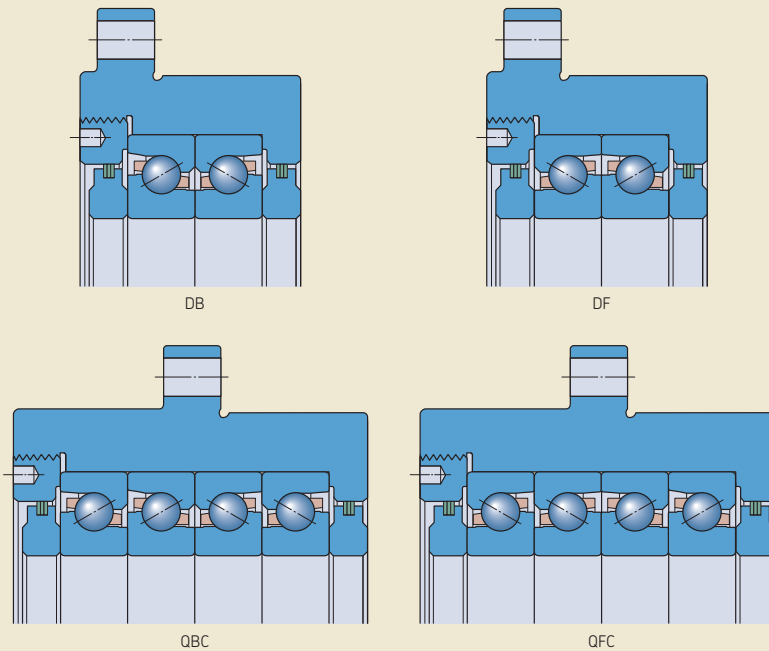

Fig. 5



Cages

Depending on their series, angular contact thrust ball bearings for screw drives are fitted as standard with one of the following cages:

- a glass fibre reinforced PA66 cage, window-type, ball centred, no designation suffix
- a glass fibre reinforced PA66 cage, snap-type, ball centred, no designation suffix

These robust cages are extremely light to minimize centrifugal forces and accommodate rapid accelerations and decelerations.

For additional information about the materials, refer to *Cage materials* (→ **page 55**).

Sealing solutions

Single direction angular contact thrust ball bearings can be supplied with an integral non-contact seal fitted on each side (designation suffix 2RZ, → **fig. 6**). The seals form an extremely narrow gap with the inner ring shoulder and therefore speed capability is not compromised.

Double direction angular contact thrust ball bearings are sealed as standard (→ **fig. 7**). They can be supplied with a contact seal (designation suffix 2RS) or a non-contact seal (designation suffix 2RZ) fitted on each side. Non-contact seals form an extremely narrow gap with the inner ring shoulder and therefore speed capability is not compromised.

The various seals are made of an oil- and wear-resistant NBR and are reinforced with sheet steel. The permissible operating temperature for seals made of NBR is -40 to $+100$ °C (-40 to $+210$ °F). Temperatures up to 120 °C (250 °F) can be tolerated for brief periods. For additional information about the materials, refer to *Seal materials* (→ **page 56**).

Cartridge units are protected on both sides with laminar rings (→ **fig. 8**) to prevent both the ingress of contaminants and the egress of grease. These seals do not limit the attainable speed for the single direction angular contact thrust ball bearings within the unit.

Sealed bearings are filled as standard with a high-quality, low-viscosity grease that has a lithium soap thickener and either a mixed ester/PAO base oil (for single direction bearings and cartridge units) or an ester base oil (for double direction bearings). The quantity of grease fills ~ 25 to 35% of the free space in the bearing. The temperature range for the greases are:

- -40 to $+120$ °C (-40 to $+250$ °F) for single direction bearings
- -55 to $+110$ °C (-65 to $+230$ °F) for double direction bearings

Under normal operating conditions, the service life of the initial fill will outlast the bearing. If double direction bearings have to accommodate heavy loads and run for long periods at high speeds, relubrication may be necessary. When relubricating, the grease should be applied slowly while the bearing is rotating at normal operating temperature. Excessive

pressure should be avoided as this could damage the seals.

Sealed bearings should not be washed or heated to temperatures above 80 °C (175 °F). If a sealed bearing is to be heated for mounting, an induction heater must be used and the bearing should be fitted immediately.

Fig. 6

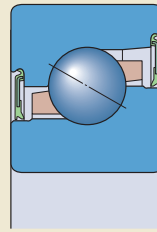

2RZ

Fig. 7

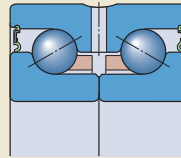

2RS

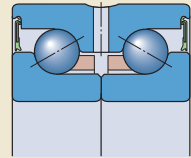

2RZ

Fig. 8

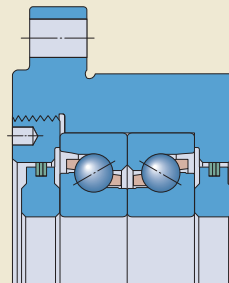

Bearing arrangement design

Single direction angular contact thrust ball bearings for screw drives enable flexible bearing arrangement designs. As standard, they are universally matchable for mounting as sets with up to four bearings per set.

Universally matchable bearings are specifically manufactured so that when mounted in random order, but immediately adjacent to each other, preload within a predetermined range and effective load sharing will result without the use of shims or similar devices. They have very tight tolerances for the bore and outside diameter as well as for radial run-out.

Bearing arrangements

Back-to-back arrangement

In a back-to-back arrangement (→ **fig. 9**), the load lines diverge along the bearing axis. Axial loads acting in both directions can be accommodated, but only by one bearing or bearing set in each direction.

Bearings mounted back-to-back provide a relatively rigid bearing arrangement. The wide span between bearing effective centres makes this arrangement particularly well suited to support moment loads.

Face-to-face arrangement

In a face-to-face arrangement (→ **fig. 10**), the load lines converge along the bearing axis. Axial loads acting in both directions can be accommodated, but only by one bearing or bearing set in each direction.

The shorter span between effective bearing centres makes face-to-face arrangements less suitable to support moment loads compared to bearings in a back-to-back arrangement.

Tandem arrangement

The use of a tandem arrangement provides increased axial and radial load carrying capacity compared to a single bearing. In a tandem arrangement (→ **fig. 11**), the load lines are parallel so that radial and axial loads are shared.

The bearing set can only accommodate axial loads acting in one direction. If axial loads act in both directions, or if combined loads are present, additional bearing(s) adjusted against the tandem arrangement must be added.

Examples

Universally matchable single direction bearings can be arranged in various ways depending on the stiffness and load requirements of the application. The possible arrangements are shown in **fig. 12** (→ **page 348**), including the applicable designation suffixes for matched sets.

If misalignment cannot be avoided between the bearing positions, face-to-face bearing arrangements are recommended. They are less sensitive to misalignment than back-to-back bearing arrangements.

Combinations of tandem arrangements with back-to-back or face-to-face arrangements

Fig. 9

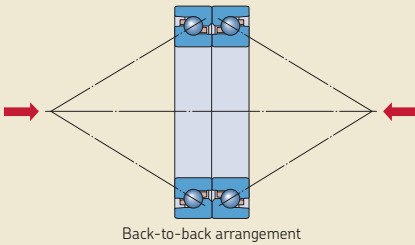

are usually selected to maximize the stiffness or load carrying capacity of a bearing set in a particular direction. This is the case, for example, when extended, preloaded, vertical or overhung screw drives must be supported.

Bearings for the non-locating position

If temperature differences between the screw drive and machine bed require a non-locating bearing in one position, needle roller bearings are suitable, among others. In this case, only the weight of the screw drive loads the bearing. Additional information about needle roller bearings is available at skf.com.

Fig. 10

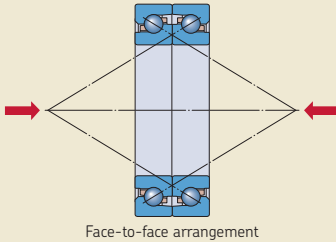
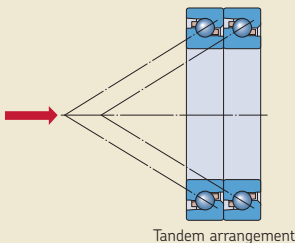
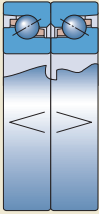

Fig. 11



Bearing sets with 2 bearings



Back-to-back arrangement
Designation suffix DB

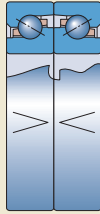

Face-to-face arrangement
Designation suffix DF

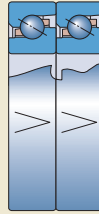

Tandem arrangement
Designation suffix DT

Bearing sets with 3 bearings

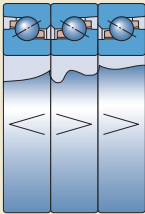

Back-to-back and tandem
arrangement
Designation suffix TBT

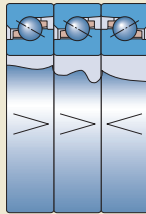

Face-to-face and tandem
arrangement
Designation suffix TFT

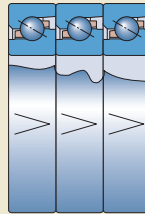

Tandem arrangement
Designation suffix TT

Bearing sets with 4 bearings

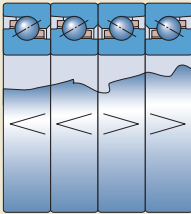

Tandem back-to-back
arrangement
Designation suffix QBC

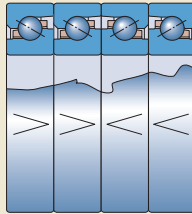

Tandem face-to-face
arrangement
Designation suffix QFC

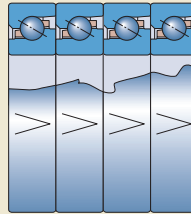

Tandem arrangement
Designation suffix QT

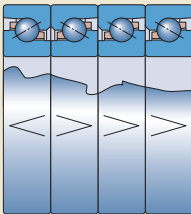

Back-to-back and tandem
arrangement
Designation suffix QBT

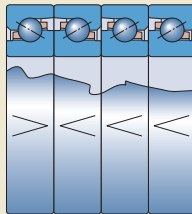

Face-to-face and tandem
arrangement
Designation suffix QFT

Associated components

Associated components should be produced very precisely so that super-precision angular contact thrust ball bearings can meet the demands for high running accuracy. All dimensional and form deviations must be kept as small as possible. The bearing seats on the shaft and in the housing should follow the recommended tolerances listed in **tables 2 to 4**.

Table 2

Geometrical accuracy of bearing shaft seats

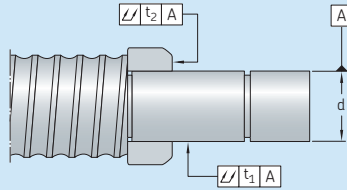

Shaft diameter		Tolerance		Total radial run-out	Total axial run-out
d over	incl.	h4 [Ⓔ] high	low	t ₁ max.	t ₂ max.
mm		μm		μm	μm
10	18	0	-5	2	2
18	30	0	-6	2,5	2,5
30	50	0	-7	2,5	2,5
50	80	0	-8	3	3

Table 3

Geometrical accuracy of bearing housing seats

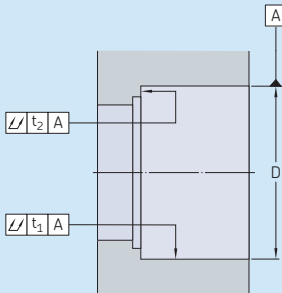

Housing diameter		Tolerance		Total radial run-out	Total axial run-out
D over	incl.	H5 [Ⓔ] high	low	t ₁ max.	t ₂ max.
mm		μm		μm	μm
-	50	11	0	2,5	4
50	80	13	0	3	5
80	120	15	0	4	6
120	150	18	0	5	8

Table 4

Geometrical accuracy of the housing bore and side faces for bearings for bolt mounting and cartridge units

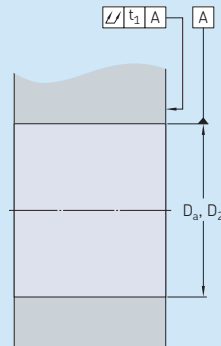

Housing bore diameter		Tolerance		Total axial run-out
D _a , D ₂ over	incl.	H6 [Ⓔ] high	low	t ₁ max.
mm		μm		μm
50	80	19	0	5
80	120	22	0	6
120	150	25	0	8

Application examples

Screw drives are typically supported at both ends with bearing sets in a back-to-back or face-to-face arrangement (→ fig. 13). With universally matchable single direction bearings, it is possible to adjust the arrangement to the requirements of a particular application. Sealed bearings (→ fig. 14) offer additional benefits. There are fewer components to install, the bearing is protected against contaminants, and no lubricant is required during mounting.

For short screw drives, an overhung support at one end is common (→ fig. 15). Back-to-back arrangements are best suited for overhung supports.

Double direction bearings (→ fig. 16) can further reduce the number of components. Bearings that are bolt mounted (→ fig. 17) do not require a housing and can be mounted easily.

For stretched screw drives, particularly stiff bearing arrangements can be designed if tandem arrangements, adjusted against each other, are used at both ends. Cartridge units with a flanged housing are particularly well suited for these screw drive designs (→ fig. 18).

Fig. 14

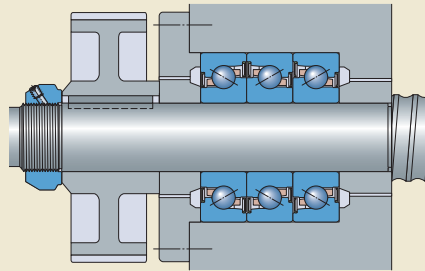

Fig. 13

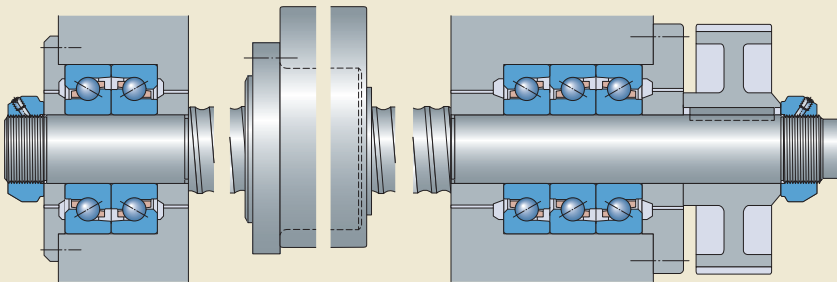

Fig. 15

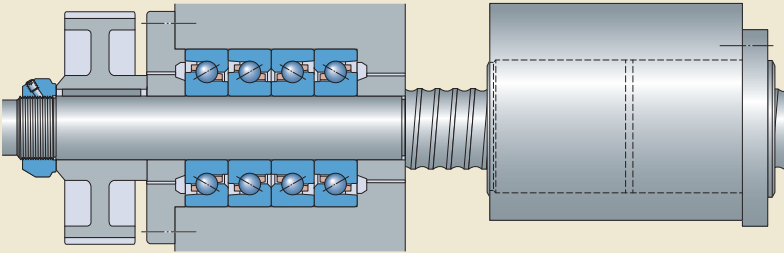

Fig. 16

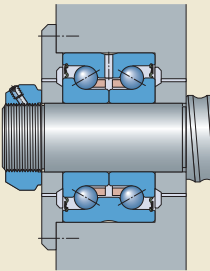

Fig. 17

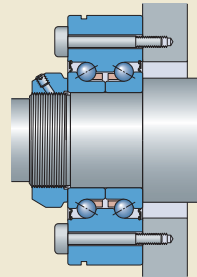
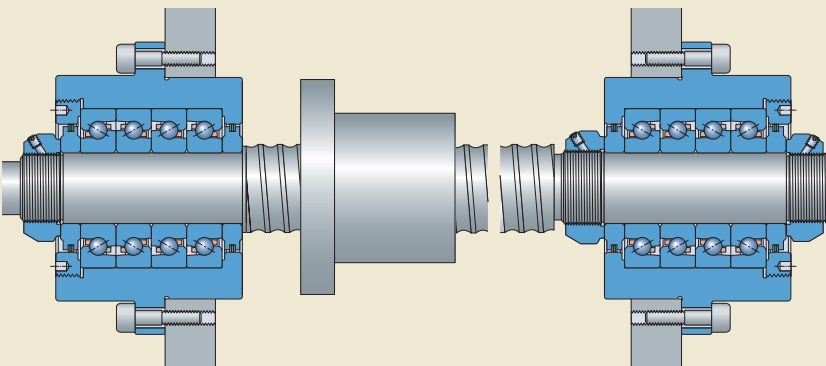

Fig. 18



Markings on bearings

Each super-precision angular contact thrust ball bearing and cartridge unit has various markings on the outside surfaces (→ fig. 19):

- 1 SKF trademark
- 2 Complete designation of the bearing/unit
- 3 Country of manufacture
- 4 Date of manufacture, coded
- 5 "MATCHABLE" label (single direction bearings only)

"V-shaped" marking

A "V-shaped" marking on the outside surface of the outer rings of universally matchable single direction bearings indicates how the bearing set should be mounted in relation to the axial load. The "V-shaped" marking points toward the side face of the inner ring that can support axial load. For sets of bearings, the large inner ring side face of the outer bearing should support axial load and should be mounted so that the "V-shaped" marking points in the direction opposite the axial load (→ fig. 20). In applications where there are axial loads in both directions supported by face-to-face or back-to-back arrangements, the inner ring side face of the outer bearing, to which the majority of the "V-shaped" markings point to, should support the heavier of the axial loads.

Fig. 20

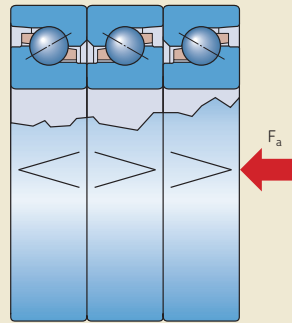
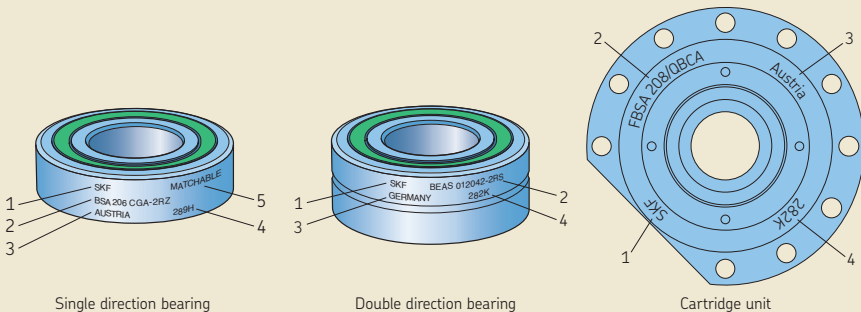

Fig. 19



Bearing data

	Single direction bearings	Double direction bearings	Cartridge units bearings
Boundary dimensions	ISO 15, only for BSA 2 and BSA 3 series that are in accordance with 02 and 03 ISO dimension series respectively BSD series bearings partly follow ISO dimension series	Not standardized	Not standardized
Tolerances For additional information (→ page 47)	P4 dimensional accuracy P2 running accuracy Values: ISO 492 (→ table 5, page 354) The values apply to individual bearings. For matched bearing sets, the axial run-out is usually within 2,5 µm if the bearing seats are machined precisely and the bearings are mounted properly.	P4 running accuracy Values: ISO 492 (→ table 5, page 354) Dimensional accuracy values: → table 5, page 354	Values: → table 6, page 354

Table 5

Tolerances of single and double direction bearings

Inner ring and bearing height

d over	incl.	Single direction bearings				S _{ia} max.	Double direction bearings				S _{ia} max.
		$\Delta_{D_{ds}}, \Delta_{D_{dmp}}$ high low		Δ_{T_s} high low			$\Delta_{D_{ds}}, \Delta_{D_{dmp}}$ high low		Δ_{B_s} high low		
mm		μm		μm		μm	μm		μm		μm
10	18	0	-4	0	-80	1,5	0	-5	0	-250	2
18	25	0	-4	0	-120	2,5	0	-5	0	-250	2
25	30	0	-4	0	-120	2,5	0	-5	0	-250	2,5
30	50	0	-5	0	-120	2,5	0	-5	0	-250	2,5
50	60	0	-5	0	-120	2,5	0	-8	0	-250	2,5
60	80	0	-5	0	-120	2,5	0	-8	0	-250	3

Outer ring

D over	incl.	Single direction bearings			S _{ea} max.	Double direction bearings				S _{ea} max.
		$\Delta_{D_{ds}}, \Delta_{D_{dmp}}$ high low		Δ_{C_s} high low		$\Delta_{D_{ds}}, \Delta_{D_{dmp}}$ high low		Δ_{C_s} high low		
mm		μm			μm	μm			μm	
30	50	0	-5	2,5	0	-10	0	-250	8	
50	80	0	-6	4	0	-10	0	-250	10	
80	110	0	-6	5	0	-10	0	-250	11	
110	120	0	-6	5	0	-15	0	-250	11	
120	150	0	-7	5	0	-15	0	-250	13	

Tolerance symbols and definitions → table 4, page 48

Table 6

Tolerances of cartridge units

d over	incl.	$\Delta_{D_{ds}}, \Delta_{D_{dmp}}$ high low		Δ_{D_2} high low		Δ_{T_s} high low		S _{ia} ¹⁾ max.
		μm		μm		mm		
18	30	0	-4	0	-13	0	-1,5	2,5
30	50	0	-5	0	-15	0	-1,5	2,5
50	60	0	-5	0	-18	0	-1,5	2,5

Tolerance symbols and definitions → table 4, page 48

¹⁾ Axial run-out of a single bearing. The tolerance for the rectangularity of the flange to the housing seat diameter D₂ is 5 to 10 μm depending on the size.

Bearing preload

Single direction bearings

An individual single direction angular contact thrust ball bearing cannot be preloaded until a second bearing provides location in the opposite direction.

SKF single direction bearings are universally matchable as standard and are manufactured pre-set to two different preload classes:

- class A, light preload
- class B, moderate preload

The amount of preload depends on various factors and applies to bearing sets in back-to-back or face-to-face arrangements. Preload values are not standardized and are listed in **table 7** (→ **page 356**). The values do not cover influences from fits or operating conditions.

Bearing sets with a non-standard preload can be supplied on request. These bearing sets are identified by the designation suffix G followed by a number. The number is the mean preload value of the set expressed in daN.

Bearing sets consisting of three or four bearings have a heavier preload than sets with two bearings. The preload for these bearing sets is obtained by multiplying the values listed in **table 7** by a factor listed in **table 8** (→ **page 356**).

Double direction bearings

Preload values for double direction angular contact thrust ball bearings are not standardized and are listed in **table 9** (→ **page 357**). The values do not cover influences from fits or operating conditions.

Bearings with a different preload can be supplied on request.

Cartridge units

Cartridge units contain single direction bearings with class A or B preload values as standard (→ **table 7, page 356**). Units containing bearings with a non-standard preload can be supplied on request. Bearing sets with a non-standard preload are identified by the designation suffix G followed by a number. The number is the mean preload value of the set expressed in daN.

Table 7

Axial preload, axial stiffness, frictional moment and maximum axial load of single direction bearings

Designation	Axial preload for preload class		Axial stiffness for preload class		Frictional moment for preload class		Maximum axial load
	A	B	A	B	A	B	
–	N		N/μm		Nm		kN
BSA 201	650	1 300	400	510	0,016	0,028	6,25
BSA 202	770	1 540	460	580	0,022	0,038	8,5
BSA 203	1 040	2 080	550	700	0,04	0,072	10,3
BSA 204	1 480	2 960	680	860	0,05	0,091	14,5
BSA 205	1 580	3 160	725	925	0,069	0,12	18
BSA 206	2 150	4 300	870	1 110	0,12	0,21	22,6
BSA 207	2 950	5 900	1 080	1 370	0,18	0,32	29,6
BSA 208	3 400	6 800	1 130	1 440	0,212	0,46	37,9
BSA 209	3 750	7 500	1 290	1 640	0,23	0,52	40,2
BSA 210	4 100	8 200	1 410	1 800	0,31	0,68	42,5
BSA 212	6 050	12 100	1 640	2 080	0,54	1,05	65
BSA 215	6 850	13 700	1 870	2 380	0,65	1,4	76
BSA 305	2 150	4 300	870	1 110	0,12	0,2	22,6
BSA 306	3 000	6 000	1 010	1 280	0,175	0,32	46
BSA 307	4 100	8 200	1 120	1 430	0,26	0,46	65
BSA 308	5 100	10 200	1 340	1 710	0,35	0,62	78,2
BSD 2047	1 480	2 960	680	860	0,05	0,091	14,5
BSD 2562	2 150	4 300	870	1 110	0,115	0,21	22,6
BSD 3062	2 150	4 300	870	1 110	0,125	0,215	22,6
BSD 3572	2 950	5 900	1 080	1 370	0,18	0,32	29,6
BSD 4072	2 950	5 900	1 080	1 370	0,18	0,32	29,6
BSD 4090	5 100	10 200	1 340	1 710	0,35	0,61	78,2
BSD 4575	2 900	5 800	1 180	1 500	0,25	0,41	40,2
BSD 45100	5 850	11 700	1 470	1 870	0,5	0,97	107,4
BSD 50100	6 200	12 400	1 550	1 970	0,52	0,97	107,4
BSD 55100	6 200	12 400	1 550	1 970	0,52	0,97	107,4
BSD 55120	7 300	14 600	1 800	2 300	0,72	1,26	130
BSD 60120	7 300	14 600	1 800	2 300	0,72	1,26	130

Table 8

Factors for calculating the preload and frictional moment of a bearing set

Number of bearings	Arrangement	Designation suffix	Factor
3	Back-to-back and tandem	TBT	1,35
	Face-to-face and tandem	TFT	1,35
4	Back-to-back and tandem	QBT	1,55
	Face-to-face and tandem	QFT	1,55
	Tandem back-to-back	QBC	2
	Tandem face-to-face	QFC	2

Table 9

Axial preload, stiffness, and frictional moment of double direction bearings

Designation	Axial preload	Stiffness		Frictional moment ¹⁾
		Axial	Moment	
–	N	N/μm	Nm/mrad	Nm
BEAS 008032	300	250	20	0,08
BEAS 012042	600	350	80	0,16
BEAS 015045	650	400	65	0,2
BEAS 017047	720	420	80	0,24
BEAS 020052	1 650	650	150	0,3
BEAS 025057	1 920	770	200	0,4
BEAS 030062	2 170	870	300	0,5
BEAM 012055	600	350	80	0,16
BEAM 017062	720	420	80	0,24
BEAM 020068	1 650	650	150	0,3
BEAM 025075	1 920	770	200	0,4
BEAM 030080	2 170	870	300	0,5
BEAM 030100	3 900	950	470	0,8
BEAM 035090	2 250	900	400	0,6
BEAM 040100	2 550	1 000	570	0,7
BEAM 040115	4 750	1 150	720	1,3
BEAM 050115	3 100	1 250	1 000	0,69
BEAM 050140	5 720	1 350	1 500	2,6
BEAM 060145	4 700	1 400	1 750	2

¹⁾ The guideline values apply to bearings with contact seals (designation suffix 2RS). For bearings with non-contact seals (designation suffix 2RZ), the frictional moment is 50% of the values listed above.

Axial stiffness

Single direction bearings

The axial stiffness values for single direction bearings are listed in **table 7** (→ **page 356**). They apply to unmounted bearing sets with two bearings arranged back-to-back or face-to-face.

Bearing sets consisting of three or four bearings provide a higher degree of axial stiffness than sets with two bearings. The axial stiffness for these bearing sets is obtained by multiplying the values listed in **table 7** by a factor listed in **table 10**. The lower value factor applies to bearings under light axial load ($P \leq 0,05 C$) and the larger value to bearings under heavy axial load ($P > 0,1 C$). To determine the equivalent dynamic bearing load P , refer to **page 361**.

Bearing sets with a heavier preload provide an even higher degree of stiffness. However, this should be avoided as heavier preload substantially increases friction and heat generated by the bearing. In cases where an extremely high degree of stiffness is required, the frictional behaviour as a function of increasing preload can be estimated using the simulation tool SKF Spindle Simulator. For additional information, contact the SKF application engineering service.

Double direction bearings

Values for axial and moment stiffness for double direction angular contact thrust ball bearings are listed in **table 9** (→ **page 357**)

and apply to the preload set at the factory. The values do not cover influences from fits or operating conditions.

Cartridge units

For cartridge units, axial stiffness is listed in **table 11**. The values correspond to those for the included single direction bearings, multiplied by the factors provided in **table 10**.

Table 10

Factors for calculating the axial stiffness of a bearing set

Number of bearings	Arrangement	Designation suffix	Factor
3	Back-to-back and tandem	TBT	1,45 to 1,65
	Face-to-face and tandem	TFT	1,45 to 1,65
4	Back-to-back and tandem	QBT	1,8 to 2,25
	Face-to-face and tandem	QFT	1,8 to 2,25
	Tandem back-to-back	QBC	2
	Tandem face-to-face	QFC	2

Table 11

Axial stiffness and frictional moment of cartridge units

Designation	Axial stiffness for preload class		Frictional moment for preload class	
	A	B	A	B
–	N/μm		Nm	
FBSA 204/DB	680	860	0,05	0,091
FBSA 204/DF	680	860	0,05	0,091
FBSA 204/QBC	1 360	1 720	0,1	0,182
FBSA 204/QFC	1 360	1 720	0,1	0,182
FBSA 205/DB	725	925	0,069	0,12
FBSA 205/DF	725	925	0,069	0,12
FBSA 205/QBC	1 450	1 850	0,138	0,24
FBSA 205/QFC	1 450	1 850	0,138	0,24
FBSA 206/DB	870	1 110	0,12	0,21
FBSA 206/DF	870	1 110	0,12	0,21
FBSA 206/QBC	1 740	2 220	0,24	0,42
FBSA 206/QFC	1 740	2 220	0,24	0,42
FBSA 206 A/QBC	1 740	2 220	0,24	0,42
FBSA 206 A/QFC	1 740	2 220	0,24	0,42
FBSA 207/DB	1 080	1 370	0,18	0,32
FBSA 207/DF	1 080	1 370	0,18	0,32
FBSA 207/QBC	2 160	2 740	0,36	0,64
FBSA 207/QFC	2 160	2 740	0,36	0,64
FBSA 208/DB	1 130	1 440	0,212	0,46
FBSA 208/DF	1 130	1 440	0,212	0,46
FBSA 208/QBC	2 260	2 880	0,424	0,92
FBSA 208/QFC	2 260	2 880	0,424	0,92
FBSA 208 A/QBC	2 260	2 880	0,424	0,92
FBSA 208 A/QFC	2 260	2 880	0,424	0,92
FBSA 209/DB	1 290	1 640	0,23	0,52
FBSA 209/DF	1 290	1 640	0,23	0,52
FBSA 209/QBC	2 580	3 280	0,46	1,04
FBSA 209/QFC	2 580	3 280	0,46	1,04
FBSA 210/DB	1 410	1 800	0,31	0,68
FBSA 210/DF	1 410	1 800	0,31	0,68
FBSA 210/QBC	2 820	3 600	0,62	1,36
FBSA 210/QFC	2 820	3 600	0,62	1,36
FBSA 210 A/QBC	2 820	3 600	0,62	1,36
FBSA 210 A/QFC	2 820	3 600	0,62	1,36
FBSA 212 A/QBC	3 280	4 160	1,08	2,1
FBSA 212 A/QFC	3 280	4 160	1,08	2,1

Frictional moment

All SKF angular contact thrust ball bearings for screw drives are designed for low friction operation. The frictional moment depends on the preload, rotational speed, seals and quantity of lubricant in the bearing set. The starting torque is typically double the frictional moment.

Single direction bearings

Guideline values for the frictional moment of single direction bearings are listed in **table 7** (→ **page 356**) and apply to unmounted bearing sets with two bearings arranged back-to-back or face-to-face that will operate at low speeds.

Bearing sets consisting of three or four bearings have a higher frictional moment than sets with two bearings. The frictional moment for these bearing sets is obtained by multiplying the values in **table 7** by a factor provided in **table 8** (→ **page 356**).

Double direction bearings

Guideline values for the frictional moment of double direction bearings are listed in **table 9** (→ **page 357**) and apply to unmounted bearings that will operate at low speeds.

Cartridge units

Guideline values for the frictional moment of cartridge units are listed in **table 11** (→ **page 359**) and apply to unmounted bearings that will operate at low speeds.

Lifting force

The external axial load on a preloaded bearing set or double direction bearing causing one ball set to become completely unloaded is called the lifting force (→ *Influence of an external load on preloaded bearing sets*, **page 91**). The lifting force for sets of single direction bearings arranged back-to-back or face-to-face and double direction bearings can be estimated using

$$K_{a1} = 2,83 F_0$$

where

K_{a1} = lifting force

F_0 = preload on bearings before external axial load is applied (→ **table 7, page 356** and **table 9, page 357**)

For additional information, contact the SKF application engineering service.

Load carrying capacity of bearing sets

The dynamic load rating C and the static load rating C_0 , as well as the fatigue load limit P_u listed in the product tables for single direction bearings apply to axial loads for individual bearings. For bearing sets, the relevant values can be obtained by applying the factors listed in **table 12** to the ratings listed for single bearings.

Equivalent bearing loads

Equivalent dynamic bearing load

If individual single direction bearings, bearing sets, or double direction bearings have to accommodate both axial and radial loads, the equivalent dynamic bearing load for each direction of axial load can be determined as follows:

$$F_a/F_r \leq 2,35 \rightarrow P = X F_r + Y F_a$$

$$F_a/F_r > 2,35 \rightarrow P = 0,97 F_r + F_a$$

For bearings that accommodate axial loads only:

$$P = F_a$$

Table 12

Load ratings, fatigue load limit, and calculation factors for bearing sets with single direction bearings

Number of bearings	Arrangement	Designation suffix	Graphic representation	Load direction	Load rating of bearing set		Fatigue load limit of bearing set	Calculation factors	
					dynamic	static		X	Y
2	Back-to-back	DB	<>	→	C	C_0	P_u	2,04	0,54
	Face-to-face	DF	><	→	C	C_0	P_u	2,04	0,54
	Tandem	DT	<<	→	1,63 C	$2 C_0$	$2 P_u$	–	–
3	Back-to-back and tandem	TBT	<>>	→	C	C_0	P_u	1,54	0,75
			<>>	←	1,63 C	$2 C_0$	$2 P_u$	2,5	0,33
	Face-to-face and tandem	TFT	>><	←	C	C_0	P_u	1,54	0,75
			>><	→	1,63 C	$2 C_0$	$2 P_u$	2,5	0,33
	Tandem	TT	<<<	→	2,16 C	$3 C_0$	$3 P_u$	–	–
4	Back-to-back and tandem	QBT	<<<>	←	C	C_0	P_u	1,26	0,87
			<<<>	→	2,16 C	$3 C_0$	$3 P_u$	2,71	0,25
	Face-to-face and tandem	QFT	>>><	←	C	C_0	P_u	1,26	0,87
			>>><	→	2,16 C	$3 C_0$	$3 P_u$	2,71	0,25
			<<>>	→	1,63 C	$2 C_0$	$2 P_u$	2,04	0,54
	Tandem back-to-back	QBC	<<>>	→	1,63 C	$2 C_0$	$2 P_u$	2,04	0,54
	Tandem face-to-face	QFC	>><<	→	1,63 C	$2 C_0$	$2 P_u$	2,04	0,54
Tandem	QT	<<<<	→	2,64 C	$4 C_0$	$4 P_u$	–	–	

where

P = equivalent dynamic load [kN]

F_r = radial load [kN]

F_a = axial load [kN]

X = radial load factor

– for single direction bearings:

→ **table 12, page 361**

– for double direction bearings: 1,9

Y = axial load factor

– for single direction bearings:

→ **table 12**

– for double direction bearings: 0,55

Preload is considered to be an axial load. For bearing sets in any arrangement, the equivalent dynamic bearing load must be calculated separately for each load direction.

Equivalent static bearing load

If individual single direction bearings, bearing sets, or double direction bearings have to accommodate both axial and radial loads, the equivalent static bearing load for each direction of axial load can be determined as follows:

$$P_0 = F_a + 4,35 F_r$$

where

P_0 = equivalent static load [kN]

F_r = radial load [kN]

F_a = axial load [kN]

Preload is considered to be an axial load. For bearing sets, in any arrangement, the equivalent static bearing load must be calculated separately for each load direction.

The equation for equivalent static bearing load applies to individual bearings and for bearings in a tandem arrangement if the load ratio F_a/F_r is not lower than 4. When F_a/F_r is between 4 and 2,5 the equation still provides useable approximation values.

Axial load carrying capacity

With increasing axial load, the contact conditions in the bearing change. The contact angle and especially the size of the contact ellipses increase, and there may be increased stress at the ring shoulder/raceway transitions. This stress is kept to a minimum for SKF super-precision bearings by appropriate measures, such as rounded and ground transition zones. Even so, the guideline values for the maximum axial load (→ **table 7, page 356**) should not be exceeded.

Mounting

Mounting instructions are either printed on the inside of the bearing box or included as a leaflet. For general information about mounting and dismounting super-precision bearings, refer to *Mounting and dismounting* (→ **page 123**).

Attainable speeds

The attainable speeds listed in the product tables are guideline values and are valid under certain conditions. For additional information, refer to *Attainable speeds* on **page 44**.

Single direction bearings

The values listed for oil lubrication apply to the oil-air lubrication method and should be reduced if other oil lubrication methods are used.

The values listed for grease lubrication are maximum values that can be attained with sealed bearings or open bearings with an appropriate fill of a suitable, high-quality, soft consistency grease. For additional information, contact the SKF application engineering service.

If bearing sets with two or more bearings are mounted immediately adjacent to each other, the attainable speeds listed in the product table (→ **page 366**) need to be reduced. Values for the maximum rotational speeds in these cases can be obtained by multiplying the guideline value listed in the product tables by a reduction factor (→ **table 13**) dependent on the preload and number of bearings in the arrangement.

Double direction bearings

The attainable speeds listed in the product tables (→ **pages 368 and 370**) for double direction bearings depend on the type of seal and are limited as follows:

- for bearings with contact seals (designation suffix 2RS) by the permissible sliding speed at the seal lip
- for bearings with non-contact seals (designation suffix 2RZ) by the speeds permitted for grease lubrication

Cartridge units

The attainable speeds listed in the product table (→ **page 372**) for cartridge units apply to mounted, grease lubricated units.

Table 13

Speed reduction factors for bearing sets

Number of bearings	Speed reduction factor for preload class	
	A	B
2	0,8	0,4
3	0,65	0,3
4	0,5	0,25

Designation system

Examples: Single direction bearing – BSA 205 CGB/GMM
 Matched set of single direction bearings – BSA 208 C/TFTA
 Double direction bearing – BEAM 030080-2RS/PE
 Cartridge unit – FBSA 206 A/QBCA

BSA 2	05	C	GB	/	
BSA 2	08	C		/	
BEAM	030080			-2RS	
FSBA 2	06	A			

Bearing series

BSA 2 Single direction bearing in the 02 ISO dimension series
BSA 3 Single direction bearing in the 03 ISO dimension series
BSD Single direction bearing
BEAS Double direction bearing
BEAM Double direction bearing for bolt mounting
FBSA 2 Cartridge unit with a flanged housing

Bearing size

For single direction bearings in accordance with an ISO dimension series

01 12 mm bore diameter
02 15 mm bore diameter
03 17 mm bore diameter
04 (x5) 20 mm bore diameter
 to
15 (x5) 75 mm bore diameter

For single direction bearings, not standardized

2047 20 mm bore diameter and 47 mm outside diameter
 to
60120 60 mm bore diameter and 120 mm outside diameter

For double direction bearings

008032 8 mm bore diameter and 32 mm outside diameter
 to
060145 60 mm bore diameter and 145 mm outside diameter

Design features

C Improved internal design (single direction bearings only)
A Different flange position (cartridge units only)

Single direction bearing – execution and preload

GA Universally matchable, light preload
GB Universally matchable, moderate preload
G... Universally matchable, special preload, expressed in daN e.g. G240

Sealing solutions

-2RS Contact seal on both sides, NBR
-2RZ Non-contact seal on both sides, NBR

GMM			
		TFT	A
	PE		
		QBC	A

Bearing set – preload

- A** Light preload
B Moderate preload
G... Special preload, expressed in daN e.g. G240

Bearing arrangement

- DB** Set of two bearings arranged back-to-back <>
DF Set of two bearings arranged face-to-face ><
DT Set of two bearings arranged in tandem <<
TBT Set of three bearings arranged back-to-back and tandem <>>
TFT Set of three bearings arranged face-to-face and tandem ><<
TT Set of three bearings arranged in tandem <<<
QBC Set of four bearings arranged tandem back-to-back <<>>
QFC Set of four bearings arranged tandem face-to-face >><<
QBT Set of four bearings arranged back-to-back and tandem <>><
QFT Set of four bearings arranged face-to-face and tandem ><<<
QT Set of four bearings arranged in tandem <<<<

Tolerance class

- Dimensional accuracy to ISO tolerance class 4, running accuracy to ISO tolerance class 2
PE Enlarged diameter tolerance and axial run-out to P5 tolerance class for radial bearing (BEAM/BEAS series only)

Grease fill

- GMM** Open single direction bearing filled with standard grease

6.1 Single direction angular contact thrust ball bearings d 12 – 75 mm

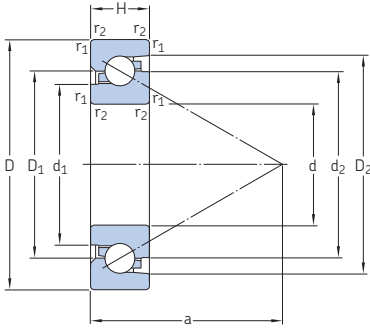

Principal dimensions			Basic load ratings		Fatigue load limit	Attainable speeds		Mass	Designation
d	D	H	dynamic C	static C ₀	P _u	Grease lubrication	Oil-air lubrication		
mm			kN		kN	r/min		kg	-
12	32	10	11,8	21,2	0,8	14 000	17 000	0,043	BSA 201 C
15	35	11	12,7	25,5	0,95	12 000	15 000	0,054	BSA 202 C
17	40	12	16,6	34,5	1,27	11 000	15 000	0,078	BSA 203 C
20	47	14	22	49	1,8	9 500	12 000	0,12	BSA 204 C
	47	15	22	49	1,8	9 500	12 000	0,13	BSD 2047 C
25	52	15	22,4	52	1,93	9 000	11 000	0,15	BSA 205 C
	62	15	28,5	71	2,65	8 000	9 500	0,24	BSD 2562 C
	62	17	28,5	71	2,65	8 000	9 500	0,27	BSA 305 C
30	62	15	28,5	71	2,65	8 000	9 500	0,22	BSD 3062 C
	62	16	28,5	71	2,65	8 000	9 500	0,23	BSA 206 C
	72	19	41,5	104	3,9	7 000	9 500	0,41	BSA 306 C
35	72	15	36,5	98	3,65	7 500	9 000	0,3	BSD 3572 C
	72	17	36,5	98	3,65	7 500	9 000	0,33	BSA 207 C
	80	21	57	146	5,4	6 700	9 500	0,56	BSA 307 C
40	72	15	36,5	98	3,65	7 500	9 000	0,26	BSD 4072 C
	80	18	42,5	112	4,15	6 300	7 500	0,43	BSA 208 C
	90	20	64	170	6,3	6 000	7 000	0,68	BSD 4090 C
	90	23	67	180	6,7	5 300	7 000	0,77	BSA 308 C
45	75	15	32,5	98	3,65	7 500	9 000	0,26	BSD 4575 C
	85	18	45	134	4,9	6 300	7 500	0,51	BSA 209 C
	100	20	65,5	183	6,7	5 600	6 700	0,77	BSD 45100 C
50	90	20	46,5	146	5,4	6 000	7 000	0,56	BSA 210 C
	100	20	67	193	7,2	5 600	6 700	0,71	BSD 50100 C
55	100	20	67	193	7,2	5 600	6 700	0,66	BSD 55100 C
	120	20	69,5	228	8,5	5 000	6 000	1,15	BSD 55120 C
60	110	22	69,5	216	8	5 000	6 000	0,95	BSA 212 C
	120	20	69,5	228	8,5	5 000	6 000	1,05	BSD 60120 C
75	130	25	72	245	9,15	4 300	5 000	1,45	BSA 215 C

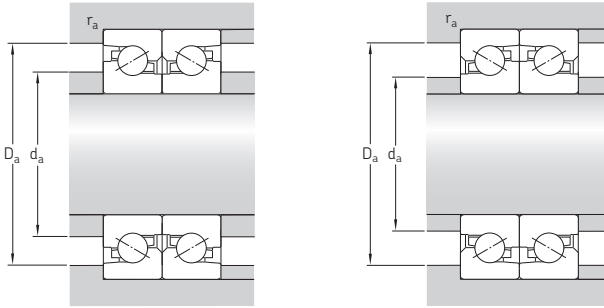

Dimensions							Abutment and fillet dimensions			Reference grease quantity ¹⁾
d	d ₁	d ₂	D ₁	D ₂	r _{1,2} min.	a	d _a min.	D _a max.	r _a max.	G _{ref}
mm							mm			cm ³
12	17,8	22	22,1	26,7	0,6	26	17	29	0,6	0,4
15	20,8	25	25,1	29,6	0,6	29	20	32	0,6	0,5
17	24,1	29	29,1	34,4	0,6	33	23	37	0,6	0,5
20	29,4	34,5	29,1	40,7	1	40	24	42	1	1,2
	29,4	34,5	34,6	40,7	1	40	27	42,5	1	1,4
25	33,4	38,5	38,6	44,7	1	44	32	47,5	1	1,5
	39,9	46	46,1	53	1	51	34	57	1	2
	39,9	46	46,1	53	1	52	34	57	1	2,4
30	39,9	46	46,1	53	1	51	38	57	1	2
	39,9	46	46,1	53	1	51	37	57	1	2,2
	43,9	51	51,1	59,5	1	57	40	65,5	1	3,5
35	48,6	55	55,1	62,7	1,1	59	44	64,8	1	2,5
	48,6	55	55,1	62,7	1,1	60	44	66	1	3
	50,1	58,5	58,6	68,6	1	66	47	72,5	1	4,2
40	48,6	55	55,1	62,7	1,1	59	47,5	65	1	2,5
	50,3	58	58,1	66,5	1,1	64	48	74	1	3,7
	57,5	66,5	66,6	77,3	1,5	73	53	81	1,5	5,2
	57,5	66,5	66,6	77,3	1,5	74	53	81	1,5	6,4
45	54,3	60	60,1	66,9	1,1	64	53	69	1	2,7
	59,4	67	67,1	75,5	1,1	73	53	79,5	1	4,5
	61,7	71,5	71,6	82,3	1,5	77	59	90	1,5	5,9
50	64,4	72	72,1	80,5	1,1	78	59	84	1	5,2
	66,9	77	77,1	87,8	1,5	82	65	90,5	1,5	6,5
55	66,9	77	77,1	87,8	1,5	82	67	91	1,5	6,5
	80,9	91	91,1	101,8	1,5	96	69	110	1,5	7,5
60	76,9	87	87,1	97,8	1,1	93	71	102	1,5	8,5
	80,9	91	91,1	101,8	1,5	96	73	111	1,5	7,5
75	91,2	100	100,1	110,8	1,5	107	85	122	1,5	11

¹⁾ For calculating the initial grease fill → page 101

6.2 Double direction angular contact thrust ball bearings

d 8 – 30 mm

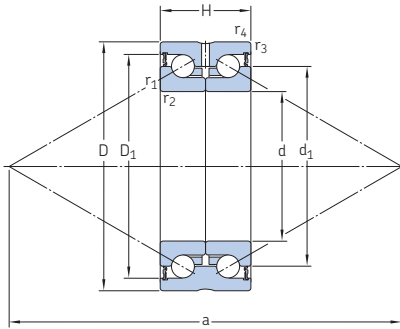

2RS

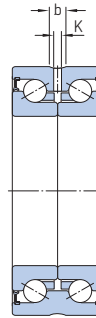

2RZ

Principal dimensions			Basic load ratings		Fatigue load limit	Attainable speed	Mass	Designation
d	D	H	dynamic C	static C ₀				
mm			kN		kN	r/min	kg	–
8	32	20	12,5	16,3	0,6	5 300	0,09	BEAS 008032-2RS
	32	20	12,5	16,3	0,6	8 800	0,09	BEAS 008032-2RZ
12	42	25	16,8	24,5	0,915	4 000	0,2	BEAS 012042-2RS
	42	25	16,8	24,5	0,915	6 700	0,2	BEAS 012042-2RZ
15	45	25	18	28	1,04	3 900	0,21	BEAS 015045-2RS
	45	25	18	28	1,04	6 500	0,21	BEAS 015045-2RZ
17	47	25	18	31	1,16	3 800	0,22	BEAS 017047-2RS
	47	25	19	31	1,16	6 300	0,22	BEAS 017047-2RZ
20	52	28	26	46,5	1,73	3 400	0,31	BEAS 020052-2RS
	52	28	26	46,5	1,73	6 000	0,31	BEAS 020052-2RZ
	52	28	26	46,5	1,73	6 000	0,31	BEAS 020052-2RZ/PE
25	57	28	27,6	55	2,04	3 400	0,34	BEAS 025057-2RS
	57	28	27,6	55	2,04	5 600	0,34	BEAS 025057-2RZ
30	62	28	29	64	2,36	3 200	0,39	BEAS 030062-2RS
	62	28	29	64	2,36	5 300	0,39	BEAS 030062-2RZ

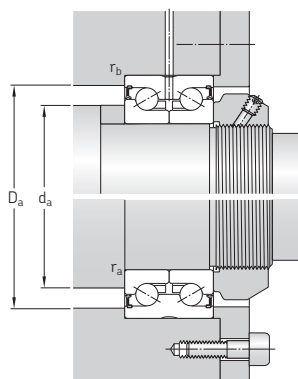

Dimensions

Abutment and fillet dimensions

d	d ₁	D ₁	b	K	r _{1,2} min.	r _{3,4} min.	a	d _a min.	D _a max.	r _a max.	r _b max.
mm								mm			
8	19	26,5	3,1	1,2	0,3	0,6	43	12	26	0,3	0,6
	19	26,5	3,1	1,2	0,3	0,6	43	12	26	0,3	0,6
12	25	33,5	3,1	2,5	0,3	0,6	56	16	35	0,3	0,6
	25	33,5	3,1	2,5	0,3	0,6	56	16	35	0,3	0,6
15	28	36	3,1	2,5	0,3	0,6	61	20	35	0,3	0,6
	28	36	3,1	2,5	0,3	0,6	61	20	35	0,3	0,6
17	30	38	3,1	2,5	0,3	0,6	65	23	40	0,3	0,6
	30	38	3,1	2,5	0,3	0,6	65	23	40	0,3	0,6
20	34,5	44	3,1	3	0,3	0,6	74	26	45	0,3	0,6
	34,5	44	3,1	3	0,3	0,6	74	26	45	0,3	0,6
	34,5	44	3,1	3	0,3	0,6	74	26	45	0,3	0,6
25	40,5	49	3,1	3	0,3	0,6	84	32	50	0,3	0,6
	40,5	49	3,1	3	0,3	0,6	84	32	50	0,3	0,6
30	45,5	54	3,1	3	0,3	0,6	93	40	54	0,3	0,6
	45,5	54	3,1	3	0,3	0,6	93	40	54	0,3	0,6

6.2

6.3 Double direction angular contact thrust ball bearings for bolt mounting d 12 – 60 mm

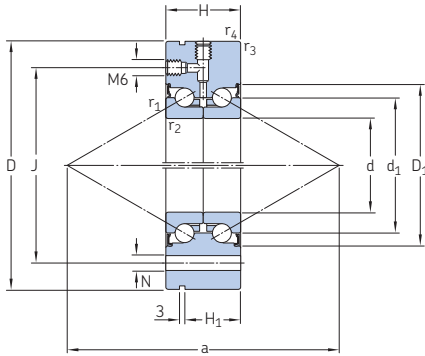

d = 60 mm

PE

Principal dimensions			Basic load ratings		Fatigue load limit	Attainable speed	Mass	Designation
d	D	H	dynamic C	static C ₀	P _u	r/min	kg	–
mm			kN		kN			
12	55	25	16,8	24,5	0,915	4 000	0,37	BEAM 012055-2RS
	55	25	16,8	24,5	0,915	6 700	0,37	BEAM 012055-2RZ
17	62	25	19	31	1,16	3 800	0,45	BEAM 017062-2RS
	62	25	19	31	1,16	3 800	0,45	BEAM 017062-2RS/PE
	62	25	19	31	1,16	6 300	0,45	BEAM 017062-2RZ
	62	25	19	31	1,16	6 300	0,45	BEAM 017062-2RZ/PE
20	68	28	26	46,5	1,73	3 400	0,61	BEAM 020068-2RS
	68	28	26	46,5	1,73	3 400	0,61	BEAM 020068-2RS/PE
	68	28	26	46,5	1,73	6 000	0,61	BEAM 020068-2RZ
	68	28	26	46,5	1,73	6 000	0,61	BEAM 020068-2RZ/PE
25	75	28	27,6	55	2,04	3 400	0,72	BEAM 025075-2RS
	75	28	27,6	55	2,04	3 400	0,72	BEAM 025075-2RS/PE
	75	28	27,6	55	2,04	5 600	0,72	BEAM 025075-2RZ
	75	28	27,6	55	2,04	5 600	0,72	BEAM 025075-2RZ/PE
30	80	28	29,1	64	2,36	2 600	0,78	BEAM 030080-2RS
	80	28	29,1	64	2,36	2 600	0,78	BEAM 030080-2RS/PE
	80	28	29,1	64	2,36	4 500	0,78	BEAM 030080-2RZ
	100	38	60	108	4	2 600	1,65	BEAM 030100-2RS
	100	38	60	108	4	4 300	1,65	BEAM 030100-2RZ
35	90	34	41	88	3,25	2 400	1,15	BEAM 035090-2RS
	90	34	41	88	3,25	4 000	1,15	BEAM 035090-2RZ
40	100	34	43,6	102	3,75	2 200	1,45	BEAM 040100-2RS
	100	34	43,6	102	3,75	3 800	1,45	BEAM 040100-2RZ
	115	46	71,5	150	5,5	1 800	2,2	BEAM 040115-2RS
	115	46	71,5	150	5,5	3 000	2,2	BEAM 040115-2RZ
50	115	34	46,8	127	4,65	2 000	1,85	BEAM 050115-2RS
	115	34	46,8	127	4,65	3 600	1,85	BEAM 050115-2RZ
	140	54	114	250	9,3	1 700	4,7	BEAM 050140-2RS
	140	54	114	250	9,3	2 800	4,7	BEAM 050140-2RZ
60	145	45	85	216	8	1 600	4,3	BEAM 060145-2RS
	145	45	85	216	8	2 600	4,3	BEAM 060145-2RZ

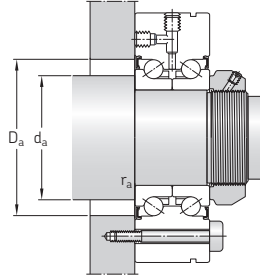
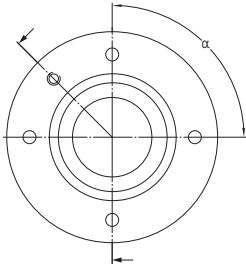

Dimensions							Abutment and fillet dimensions			Holes for attachment bolts in accordance with DIN 912			
d	d ₁	D ₁	H ₁	r _{1,2} min.	r _{3,4} min.	a	d _a min.	D _a max.	r _a max.	Size	Dimensions J	N	Pitch nr. x α [°]
mm	mm	mm	mm	mm	mm	mm	mm	mm	mm	–	mm	–	–
12	25	33,5	17	0,3	0,6	56	16	33	0,6	M6	42	6,8	3x120
	25	33,5	17	0,3	0,6	56	16	33	0,6	M6	42	6,8	3x120
17	30	38	17	0,3	0,6	65	23	38	0,6	M6	48	6,8	3x120
	30	38	17	0,3	0,6	65	23	38	0,6	M6	48	6,8	3x120
	30	38	17	0,3	0,6	65	23	38	0,6	M6	48	6,8	3x120
	30	38	17	0,3	0,6	65	23	38	0,6	M6	48	6,8	3x120
20	34,5	44	19	0,3	0,6	74	25	44	0,6	M6	53	6,8	4x90
	34,5	44	19	0,3	0,6	74	25	44	0,6	M6	53	6,8	4x90
	34,5	44	19	0,3	0,6	74	25	44	0,6	M6	53	6,8	4x90
	34,5	44	19	0,3	0,6	74	25	44	0,6	M6	53	6,8	4x90
25	40,5	49	19	0,3	0,6	84	32	49	0,6	M6	58	6,8	4x90
	40,5	49	19	0,3	0,6	84	32	49	0,6	M6	58	6,8	4x90
	40,5	49	19	0,3	0,6	84	32	49	0,6	M6	58	6,8	4x90
	40,5	49	19	0,3	0,6	84	32	49	0,6	M6	58	6,8	4x90
30	45,5	54	19	0,3	0,6	93	40	54	0,6	M6	63	6,8	6x60
	45,5	54	19	0,3	0,6	93	40	54	0,6	M6	63	6,8	6x60
	45,5	54	19	0,3	0,6	93	40	54	0,6	M6	63	6,8	6x60
	51	65	30	0,3	0,6	106	47	65	0,6	M8	80	8,8	8x45
	51	65	30	0,3	0,6	106	47	65	0,6	M8	80	8,8	8x45
35	52	63	25	0,3	0,6	107	45	63	0,6	M8	75	8,8	4x90
	52	63	25	0,3	0,6	107	45	63	0,6	M8	75	8,8	4x90
40	58	68	25	0,3	0,6	117	50	68	0,6	M8	80	8,8	4x90
	58	68	25	0,3	0,6	117	50	68	0,6	M8	80	8,8	4x90
	65	80	36	0,6	0,6	134	56	80	0,6	M8	94	8,8	12x30
	65	80	36	0,6	0,6	134	56	80	0,6	M8	94	8,8	12x30
50	72	82	25	0,3	0,6	141	63	82	0,6	M8	94	8,8	6x60
	72	82	25	0,3	0,6	141	63	82	0,6	M8	94	8,8	6x60
	80	98	45	0,6	0,6	166	63	98	0,6	M10	113	11	12x30
	80	98	45	0,6	0,6	166	63	98	0,6	M10	113	11	12x30
60	85	100	35	0,6	0,6	168	82	100	0,6	M8	120	8,8	8x45
	85	100	35	0,6	0,6	168	82	100	0,6	M8	120	8,8	8x45

6.4 Cartridge units with a flanged housing d 20 – 60 mm

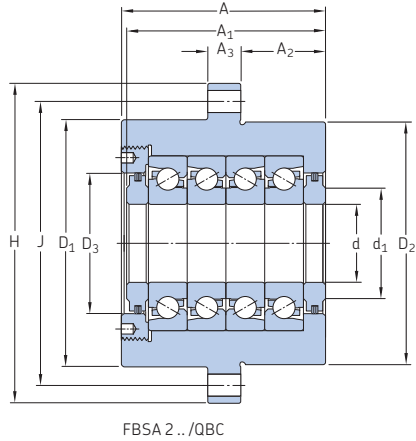
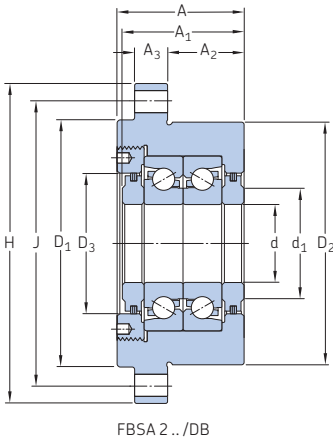

Principal dimensions			Basic load ratings		Fatigue load limit	Attainable speeds Preload class		Mass	Designation
d	H	A	dynamic C	static C ₀	P _u	A	B		
mm			kN		kN	r/min		kg	–
20	90	47	22	49	1,8	7 600	3 800	1,1	FBSA 204/DB
	90	47	22	49	1,8	7 600	3 800	1,1	FBSA 204/DF
	90	77	35,9	98	3,6	4 750	2 375	1,7	FBSA 204/QBC
	90	77	35,9	98	3,6	4 750	2 375	1,7	FBSA 204/QFC
25	120	52	22,4	52	1,93	7 200	3 600	2,3	FBSA 205/DB
	120	52	22,4	52	1,93	7 200	3 600	2,3	FBSA 205/DF
	120	82	36,5	104	3,86	4 500	2 250	3,5	FBSA 205/QBC
	120	82	36,5	104	3,86	4 500	2 250	3,5	FBSA 205/QFC
30	120	52	28,5	71	2,65	6 400	3 200	2,5	FBSA 206/DB
	120	52	28,5	71	2,65	6 400	3 200	2,5	FBSA 206/DF
	120	84	46,5	142	5,3	4 000	2 000	3,5	FBSA 206/QBC
	120	84	46,5	142	5,3	4 000	2 000	3,5	FBSA 206/QFC
	120	86	46,5	142	5,3	4 000	2 000	3,7	FBSA 206 A/QBC
	120	86	46,5	142	5,3	4 000	2 000	3,7	FBSA 206 A/QFC
35	130	52	36,5	98	3,65	5 600	2 800	3,2	FBSA 207/DB
	130	52	36,5	98	3,65	5 600	2 800	3,2	FBSA 207/DF
	130	86	59,5	196	7,3	3 500	1 750	4,6	FBSA 207/QBC
	130	86	59,5	196	7,3	3 500	1 750	4,6	FBSA 207/QFC
40	165	66	42,5	112	4,15	5 040	2 520	6,1	FBSA 208/DB
	165	66	42,5	112	4,15	5 040	2 520	6,1	FBSA 208/DF
	165	106	69,3	224	8,3	3 150	1 575	9,7	FBSA 208/QBC
	165	106	69,3	224	8,3	3 150	1 575	9,7	FBSA 208/QFC
	165	106	69,3	224	8,3	3 150	1 575	10	FBSA 208 A/QBC
	165	106	69,3	224	8,3	3 150	1 575	10	FBSA 208 A/QFC
45	165	66	45	134	4,9	5 040	2 520	5,9	FBSA 209/DB
	165	66	45	134	4,9	5 040	2 520	5,9	FBSA 209/DF
	165	106	73,4	268	9,8	3 150	1 575	9,4	FBSA 209/QBC
	165	106	73,4	268	9,8	3 150	1 575	9,4	FBSA 209/QFC
50	165	66	46,5	146	5,4	4 800	2 400	5,7	FBSA 210/DB
	165	66	46,5	146	5,4	4 800	2 400	5,7	FBSA 210/DF
	165	106	75,8	292	10,8	3 000	1 500	9,1	FBSA 210/QBC
	165	106	75,8	292	10,8	3 000	1 500	9,1	FBSA 210/QFC
	165	106	75,8	292	10,8	3 000	1 500	9,3	FBSA 210 A/QBC
	165	106	75,8	292	10,8	3 000	1 500	9,3	FBSA 210 A/QFC
60	185	114	113	432	16	2 500	1 250	12,5	FBSA 212 A/QBC
	185	114	113	432	16	2 500	1 250	12,5	FBSA 212 A/QFC

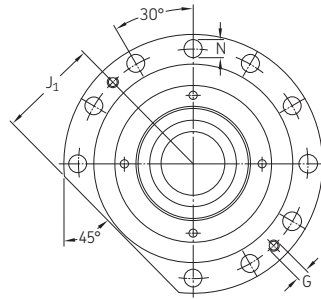
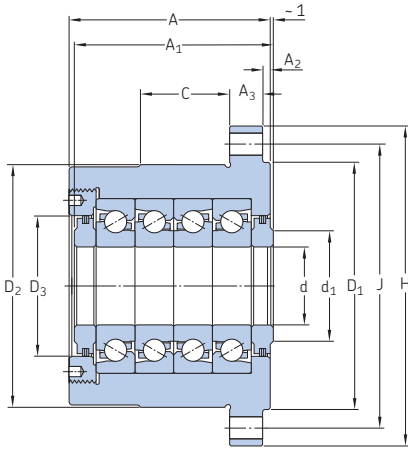

FBSA 2.. A/QBC

Dimensions

Holes for attachment bolts

d	A ₁	A ₂	A ₃	C	d ₁	D ₁	D ₂	D ₃	J	J ₁	N	G
mm									mm			
20	44,26	32	13	–	26	64	60	36	76	32	6,6	–
	43,24	32	13	–	26	64	60	36	76	32	6,6	–
	74,26	32	13	–	26	64	60	36	76	32	6,6	–
	72,74	32	13	–	26	64	60	36	76	32	6,6	–
25	50,26	32	15	–	34	88	80	36	102	44	9,2	–
	49,24	32	15	–	34	88	80	36	102	44	9,2	–
	80,26	32	15	–	34	88	80	40	102	44	9,2	–
	78,74	32	15	–	34	88	80	40	102	44	9,2	–
30	50,26	32	15	–	41	88	80	50	102	44	9,2	–
	49,24	32	15	–	41	88	80	50	102	44	9,2	–
	82,26	32	15	–	41	88	80	50	102	44	9,2	–
	80,74	32	15	–	41	88	80	50	102	44	9,2	–
	86,26	3,5	15	35	41	88	88	50	102	45	9,2	M8x1,25
	86,26	3,5	15	35	41	88	88	50	102	45	9,2	M8x1,25
35	50,26	32	15	–	46	98	90	60	113	49	9,2	–
	49,24	32	15	–	46	98	90	60	113	49	9,2	–
	84,26	32	15	–	46	98	90	60	113	49	9,2	–
	82,74	32	15	–	46	98	90	60	113	49	9,2	–
40	64,26	43,5	17	–	55	128	124	66	146	64	11,4	–
	63,24	43,5	17	–	55	128	124	66	146	64	11,4	–
	104,26	43,5	17	–	55	128	124	66	146	64	11,4	–
	102,74	43,5	17	–	55	128	124	66	146	64	11,4	–
	106,26	4	24	35	55	128	128	66	146	65,5	11,4	M10x1,5
	106,26	4	24	35	55	128	128	66	146	65,5	11,4	M10x1,5
45	64,26	43,5	17	–	66	128	124	76	146	64	11,4	–
	63,24	43,5	17	–	66	128	124	76	146	64	11,4	–
	104,26	43,5	17	–	66	128	124	76	146	64	11,4	–
	102,74	43,5	17	–	66	128	124	76	146	64	11,4	–
50	64,26	43,5	17	–	66	128	124	76	146	64	11,4	–
	63,24	43,5	17	–	66	128	124	76	146	64	11,4	–
	104,26	43,5	17	–	66	128	124	76	146	64	11,4	–
	102,74	43,5	17	–	66	128	124	76	146	64	11,4	–
	106,26	4	24	35	66	128	128	76	146	65,5	11,4	M10x1,5
	106,26	4	24	35	66	128	128	76	146	65,5	11,4	M10x1,5
60	114,26	20,5	25	40	80	145	145	92	165	74,5	11,4	M10x1,5
	114,26	20,5	25	40	80	145	145	92	165	74,5	11,4	M10x1,5



Precision lock nuts

Designs	376
Precision lock nuts with locking pins . . .	376
Precision lock nuts with axial locking screws	377
Product data	378
(Dimension standards, tolerances, mating shaft threads, materials, loosening torque)	
Installation and removal	379
KMT and KMTA precision lock nuts	380
KMD precision lock nuts	381
Designation system	382

Product tables

7.1 KMT precision lock nuts with locking pins	384
7.2 KMTA precision lock nuts with locking pins	386
7.3 KMD precision lock nuts with axial locking screws	388

More information

Design considerations	57
SKF maintenance products	→ skf.com/mapro

Industrial lock nuts with lock washers are not considered to be suitable for super-precision bearing applications because of the relatively wide manufacturing tolerances of the thread and abutment surfaces. As a result, SKF has developed a full line of precision lock nuts that are manufactured within very tight tolerances. These simple to mount devices, which locate bearings and other components accurately and efficiently on a shaft, meet the requirements of machine tool applications, both technically and economically.

Designs

All SKF precision lock nuts use friction between the mating thread flanks of the spindle shaft and lock nut to hold them in place. To apply this friction, SKF manufactures two different precision lock nut designs: those with locking pins and those with axial locking screws.

Precision lock nuts with locking pins

KMT and KMTA series precision lock nuts (→ **fig. 1**) have three locking pins, equally spaced around their circumference, with their axes parallel to the loaded thread flank (→ **fig. 2**). When tightened, the locking pins preload the threads, which provides sufficient friction to prevent the nut from loosening under normal operating conditions (→ *Loosening torque*, **page 378**).

KMT and KMTA lock nuts are intended for applications where high precision, simple assembly and reliable locking are required. The three equally-spaced locking pins enable these lock nuts to be accurately positioned at right angles to the shaft. However, they can also be adjusted to compensate for slight angular deviations of adjacent components (→ *Installation and removal*, **page 379**).

KMT and KMTA lock nuts should not be used on shafts or adapter sleeves with keyways or key slots. Damage to the locking pins can result if they align with a keyway or slot.

Both lock nut series are available standard with a thread up to 200 mm (size 40). KMT lock nuts with a thread ranging from 220 to 420 mm (sizes 44 to 84) can be supplied on request. For additional information, contact the SKF application engineering service.

KMTA lock nuts have a cylindrical outside surface and, for some sizes, a different thread pitch than KMT lock nuts. They are intended primarily for applications where space is limited and the cylindrical outside surface can be used as an element of a gap-type seal.

Fig. 1

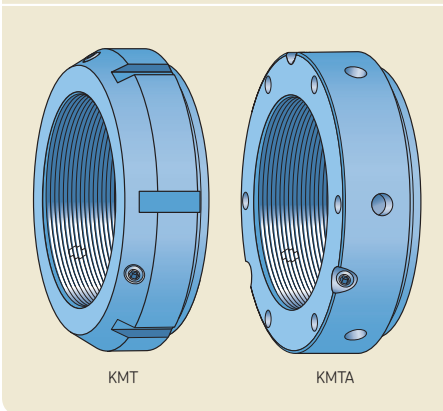
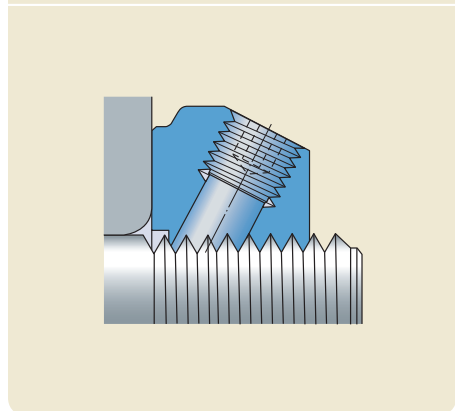

Fig. 2



Precision lock nuts with axial locking screws

Precision lock nuts in the KMD series (→ **fig. 3**) are preloaded with axial locking screws. After the front part of the lock nut is tightened against the bearing, the axial locking screws on the rear part are tightened (→ **fig. 4**). This preloads the threads and generates sufficient friction to prevent the nut from loosening under normal operating conditions (→ *Loosening torque*, **page 378**).

Installing and removing KMD lock nuts is simple and the axial location effective and reliable. It is possible to make micro adjustments of the axial position using the locking screws (→ *Installation and removal*, **page 379**).

Fig. 3

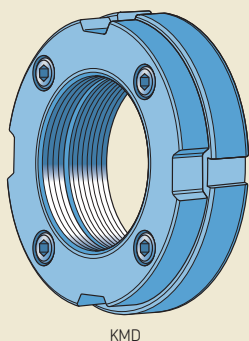
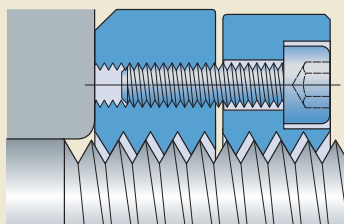

Fig. 4



Product data

	KMT and KMTA series	KMD series
Dimension standards	ISO 965-3	ISO 965-3 Locking screws: DIN 912-12.9
Tolerances	Metric thread, 5H: ISO 965-3 Maximum axial run-out locating face / thread (for thread up to and including size 40): 0,005 mm	Metric thread, 5H: ISO 965-3 Maximum axial run-out locating face / thread: 0,005 mm
Mating shaft threads	Metric thread, 6g: ISO 965-3	
Materials	Steel	Steel For sizes 11 and 12: sintered steel (designation suffix P)
Loosening torque	<p>KMT, KMTA and KMD lock nuts are held in place on a shaft by friction. The amount of friction can vary, depending on the amount of torque applied to the grub (set) screws or axial locking screws during installation, the surface finish of the shaft thread, the amount of lubricant on the thread, etc.</p> <p>Experience shows that the locking mechanism of KMT, KMTA and KMD lock nuts is more than adequate for typical machine tool applications, provided the lock nuts are properly installed and there is only a limited amount of lubricant on the thread.</p> <p>For additional information, contact the SKF application engineering service.</p>	

Installation and removal

KMT and KMD precision lock nuts have slots around their circumference to accommodate a hook or impact spanner (→ **figs. 5 and 6**). The designations of the appropriate spanners are listed in the product tables for KMT nuts (→ **page 384**) and KMD nuts (→ **page 388**). For additional information about SKF spanners, visit skf.com/mapro. In addition to the slots, KMT lock nuts with a thread ≤ 75 mm (size ≤ 15) have two opposed flats to accommodate a spanner.

KMTA precision lock nuts have holes around their circumference and in one side face (→ **fig. 7**). They can be tightened with a pin wrench, a pin-type face spanner or a tommy bar. Appropriate spanners in accordance with DIN 1810 are listed in the product tables.

All SKF precision lock nuts are designed for frequent installation and removal (provided they are not damaged).

Fig. 5

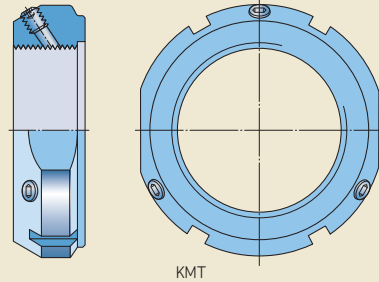

KMT

Fig. 6

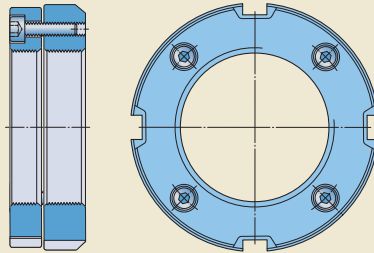

KMD

Fig. 7

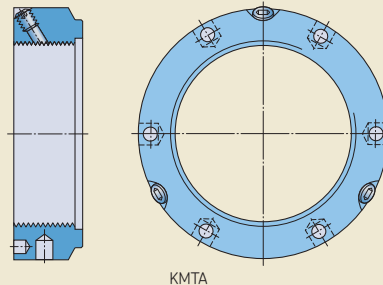

KMTA

KMT and KMTA precision lock nuts

Locking

KMT and KMTA lock nuts should be locked in two phases:

- 1 Tighten the grub (set) screws carefully until the locking pins engage the shaft thread.
- 2 Tighten the grub screws alternately with a torque wrench until the recommended torque value is achieved (→ **product tables, pages 384 and 386**).

Adjustment

KMT and KMTA lock nuts are adjustable. The three equally-spaced locking pins enable these lock nuts to be accurately positioned at right angles to the shaft. However, they can also be adjusted to compensate for slight angular deviations of adjacent components. Adjustments can be made using the following procedure (→ **fig. 8**):

- 1 Loosen the grub screw(s) at the position showing the greatest deviation.
- 2 Tighten the remaining screw(s) equally.
- 3 Retighten the screw(s) that were loosened.
- 4 Check that the alignment of the nut, relative to the shaft, is now as required.

- 5 Repeat the procedure if the result is not adequate.

Removal

When removing KMT and KMTA lock nuts, the locking pins can still engage the shaft thread even after the grub screws have been loosened. Using a rubber hammer, tap the nut lightly in the vicinity of the pins to loosen them.

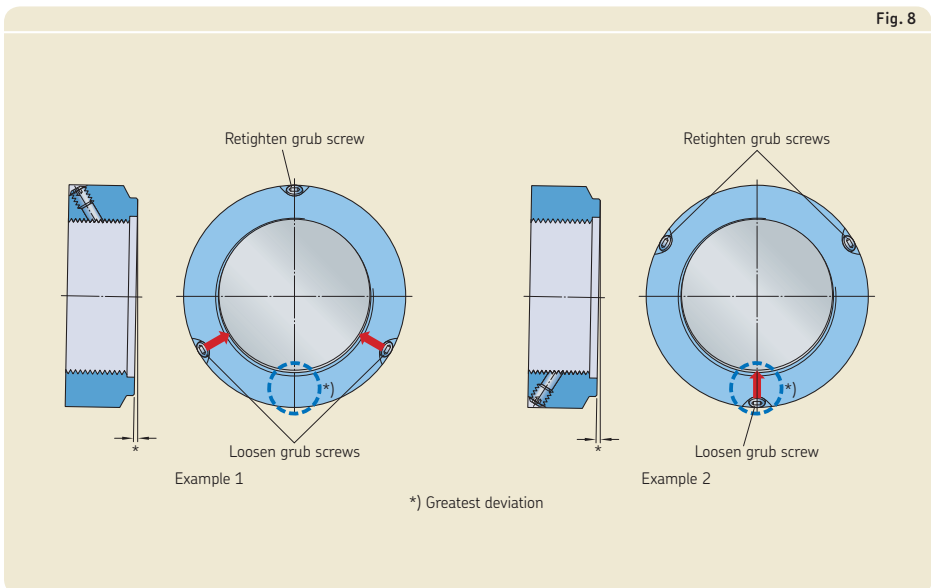

KMD precision lock nuts

KMD lock nuts are supplied with a protector between the front and rear part of the lock nut. The axial locking screws are “finger tight” to keep the protector in place. To install the lock nut (→ **fig. 9**):

- 1 Loosen the locking screws (1) half a turn. Do not remove them.
- 2 Remove the protector (2) between the two parts of the lock nut.
- 3 Hold the front and rear parts together and screw the lock nut onto the shaft. When the rear part grabs onto the shaft thread, a gap occurs between the two parts of approximately:
 - 0,6 mm for KMD 4 lock nuts
 - 1,0 mm for KMD 5 to KMD 15 lock nuts
 - 1,2 mm for KMD 16 to KMD 21 lock nuts

The remaining steps depend on whether adjustment to an exact position on the shaft is required.

When precise positioning is not required

- 4 Screw the lock nut to its final position on the shaft thread, engaging the spanner in the slots on the front part of the nut.
- 5 Tighten the locking screws alternately in a criss-cross pattern until the recommended torque value is obtained (→ **product table, page 388**). Screw sizes are listed in the product tables.

When precise positioning is required

- 4 Screw the lock nut to an approximate position on the shaft thread, engaging the spanner in the slots on the front part of the nut.
- 5 Tighten the locking screws alternately in a criss-cross pattern to half the recommended torque value (→ **product table**). Screw sizes are listed in the product tables.
- 6 Adjust the nut to its final position on the shaft (placing the spanner in the slots on the front part of the nut).
- 7 Tighten the locking screws alternately in a criss-cross pattern to the full recommended torque.

Fig. 9

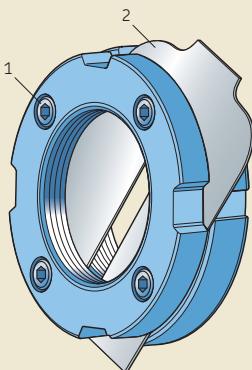

Designation system

Examples: KMTA 24
KMD 12 P

KMTA	24	
KMD	12	P

Series

- KMT** Precision lock nut with locking pins
- KMTA** Precision lock nut with locking pins and with cylindrical outside surface (some with different thread pitch to KMT nuts)
- KMD** Two-part precision lock nut with axial locking screws

Nut size

- 0** 10 mm thread diameter
- 1** 12 mm thread diameter
- 2** 15 mm thread diameter
- 3** 17 mm thread diameter
- 4** (x5) 20 mm thread diameter
- to
- 84** (x5) 420 mm thread diameter

Material

- Steel
- P** Sintered steel (For KMD 11 and KMD 12 lock nuts only)

7.1 KMT precision lock nuts with locking pins M 10x0,75 – M 200x3

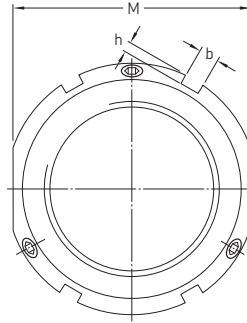
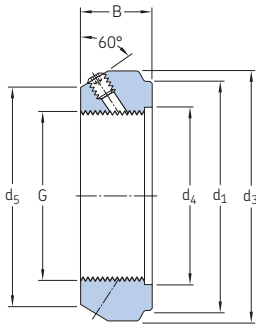

Dimensions										Axial load carrying capacity static	Mass	Designations		Grub (set) screw	
G	d ₁	d ₃	d ₄	d ₅	B	b	h	M	Lock nut			Appropriate spanner	Size	Recommended tightening torque	
mm										kN	kg	-		-	Nm
M 10x0,75	23	28	11	21	14	4	2	24	35	0,045	KMT 0	HN 2-3	M 5	4,5	
M 12x1	25	30	13	23	14	4	2	27	40	0,05	KMT 1	HN 4	M 5	4,5	
M 15x1	28	33	16	26	16	4	2	30	60	0,075	KMT 2	HN 4	M 5	4,5	
M 17x1	33	37	18	29	18	5	2	34	80	0,1	KMT 3	HN 5-6	M 6	8	
M 20x1	35	40	21	32	18	5	2	36	90	0,11	KMT 4	HN 5-6	M 6	8	
M 25x1,5	39	44	26	36	20	5	2	41	130	0,13	KMT 5	HN 5-6	M 6	8	
M 30x1,5	44	49	32	41	20	5	2	46	160	0,16	KMT 6	HN 7	M 6	8	
M 35x1,5	49	54	38	46	22	5	2	50	190	0,19	KMT 7	HN 7	M 6	8	
M 40x1,5	59	65	42	54	22	6	2,5	60	210	0,3	KMT 8	HN 8-9	M 8	18	
M 45x1,5	64	70	48	60	22	6	2,5	65	240	0,33	KMT 9	HN 10-11	M 8	18	
M 50x1,5	68	75	52	64	25	7	3	70	300	0,4	KMT 10	HN 10-11	M 8	18	
M 55x2	78	85	58	74	25	7	3	80	340	0,54	KMT 11	HN 12-13	M 8	18	
M 60x2	82	90	62	78	26	8	3,5	85	380	0,61	KMT 12	HN 12-13	M 8	18	
M 65x2	87	95	68	83	28	8	3,5	90	460	0,71	KMT 13	HN 15	M 8	18	
M 70x2	92	100	72	88	28	8	3,5	95	490	0,75	KMT 14	HN 15	M 8	18	
M 75x2	97	105	77	93	28	8	3,5	100	520	0,8	KMT 15	HN 16	M 8	18	
M 80x2	100	110	83	98	32	8	3,5	-	620	0,9	KMT 16	HN 17	M 8	18	
M 85x2	110	120	88	107	32	10	4	-	650	1,15	KMT 17	HN 18-20	M 10	35	
M 90x2	115	125	93	112	32	10	4	-	680	1,2	KMT 18	HN 18-20	M 10	35	
M 95x2	120	130	98	117	32	10	4	-	710	1,25	KMT 19	HN 18-20	M 10	35	
M 100x2	125	135	103	122	32	10	4	-	740	1,3	KMT 20	HN 21-22	M 10	35	

Dimensions								Axial load carrying capacity static	Mass	Designations		Grub (set) screw	
G	d ₁	d ₃	d ₄	d ₅	B	b	h			Lock nut	Appropriate spanner	Size	Recommended tightening torque
mm								kN	kg	–	–	Nm	
M 110x2	134	145	112	132	32	10	4	800	1,45	KMT 22	HN 21-22	M 10	35
M 120x2	144	155	122	142	32	10	4	860	1,6	KMT 24	HN 21-22	M 10	35
M 130x2	154	165	132	152	32	12	5	920	1,7	KMT 26	TMFN 23-30	M 10	35
M 140x2	164	175	142	162	32	14	5	980	1,8	KMT 28	TMFN 23-30	M 10	35
M 150x2	174	185	152	172	32	14	5	1 040	1,95	KMT 30	TMFN 23-30	M 10	35
M 160x3	184	195	162	182	32	14	5	1 100	2,1	KMT 32	TMFN 23-30	M 10	35
M 170x3	192	205	172	192	32	14	5	1 160	2,2	KMT 34	TMFN 30-40	M 10	35
M 180x3	204	215	182	202	32	16	5	1 220	2,3	KMT 36	TMFN 30-40	M 10	35
M 190x3	214	225	192	212	32	16	5	1 280	2,4	KMT 38	TMFN 30-40	M 10	35
M 200x3	224	235	202	222	32	18	5	1 340	2,5	KMT 40	TMFN 30-40	M 10	35

7.2 KMTA precision lock nuts with locking pins M 25x1,5 – M 200x3

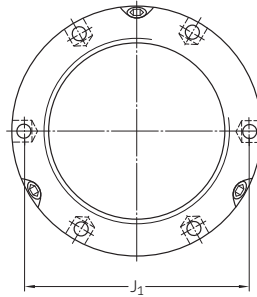
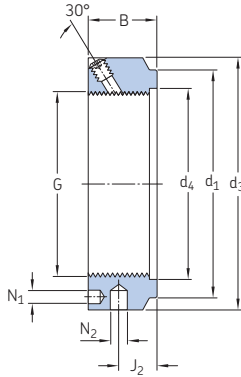

Dimensions										Axial load carrying capacity static	Mass	Designations		Grub (set) screw		
G	d ₁	d ₃	d ₄	B	J ₁	J ₂	N ₁	N ₂	Lock nut			Appropriate spanner	Size	Recommended tightening torque		
mm										kN	kg	-		-		Nm
M 25x1,5	35	42	26	20	32,5	11	4,3	4	130	0,13	KMTA 5	B 40-42	M 6	8		
M 30x1,5	40	48	32	20	40,5	11	4,3	5	160	0,16	KMTA 6	B 45-50	M 6	8		
M 35x1,5	47	53	38	20	45,5	11	4,3	5	190	0,19	KMTA 7	B 52-55	M 6	8		
M 40x1,5	52	58	42	22	50,5	12	4,3	5	210	0,23	KMTA 8	B 58-62	M 6	8		
M 45x1,5	58	68	48	22	58	12	4,3	6	240	0,33	KMTA 9	B 68-75	M 6	8		
M 50x1,5	63	70	52	24	61,5	13	4,3	6	300	0,34	KMTA 10	B 68-75	M 6	8		
M 55x1,5	70	75	58	24	66,5	13	4,3	6	340	0,37	KMTA 11	B 68-75	M 6	8		
M 60x1,5	75	84	62	24	74,5	13	5,3	6	380	0,49	KMTA 12	B 80-90	M 8	18		
M 65x1,5	80	88	68	25	78,5	13	5,3	6	460	0,52	KMTA 13	B 80-90	M 8	18		
M 70x1,5	86	95	72	26	85	14	5,3	8	490	0,62	KMTA 14	B 95-100	M 8	18		
M 75x1,5	91	100	77	26	88	13	6,4	8	520	0,66	KMTA 15	B 95-100	M 8	18		
M 80x2	97	110	83	30	95	16	6,4	8	620	1	KMTA 16	B 110-115	M 8	18		
M 85x2	102	115	88	32	100	17	6,4	8	650	1,15	KMTA 17	B 110-115	M 10	35		
M 90x2	110	120	93	32	108	17	6,4	8	680	1,2	KMTA 18	B 120-130	M 10	35		
M 95x2	114	125	98	32	113	17	6,4	8	710	1,25	KMTA 19	B 120-130	M 10	35		
M 100x2	120	130	103	32	118	17	6,4	8	740	1,3	KMTA 20	B 120-130	M 10	35		
M 110x2	132	140	112	32	128	17	6,4	8	800	1,45	KMTA 22	B 135-145	M 10	35		
M 120x2	142	155	122	32	140	17	6,4	8	860	1,85	KMTA 24	B 155-165	M 10	35		
M 130x3	156	165	132	32	153	17	6,4	8	920	2	KMTA 26	B 155-165	M 10	35		
M 140x3	166	180	142	32	165	17	6,4	10	980	2,45	KMTA 28	B 180-195	M 10	35		
M 150x3	180	190	152	32	175	17	6,4	10	1 040	2,6	KMTA 30	B 180-195	M 10	35		

Dimensions										Axial load carrying capacity static	Mass	Designations		Grub (set) screw	
G	d ₁	d ₃	d ₄	B	J ₁	J ₂	N ₁	N ₂	Lock nut			Appropriate spanner	Size	Recommended tightening torque	
mm									kN	kg	–	–	Nm		
M 160x3	190	205	162	32	185	17	8,4	10	1 100	3,15	KMTA 32	B 205-220	M 10	35	
M 170x3	205	215	172	32	195	17	8,4	10	1 160	3,3	KMTA 34	B 205-220	M 10	35	
M 180x3	215	230	182	32	210	17	8,4	10	1 220	3,9	KMTA 36	B 230-245	M 10	35	
M 190x3	225	240	192	32	224	17	8,4	10	1 280	4,1	KMTA 38	B 230-245	M 10	35	
M 200x3	237	245	202	32	229	17	8,4	10	1 340	3,85	KMTA 40	B 230-245	M 10	35	

7.3 KMD precision lock nuts with axial locking screws M 20x1 – M 105x2

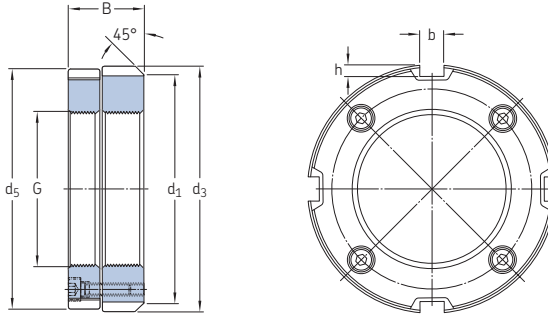

Dimensions							Axial load carrying capacity static	Mass	Designations Lock nut	Appropriate spanner	Locking screws	
G	d ₁	d ₃	d ₅	B	b	h					Size	Recommended tightening torque
mm							kN	kg	-	-	Nm	
M 20x1	38	40	39	18	5	2	70	0,11	KMD 4	HN 5-6	M 4	4,2
M 25x1,5	43	45	44	20	5	2	95	0,14	KMD 5	HN 5-6	M 4	4,2
M 30x1,5	48	50	49	20	5	2	105	0,2	KMD 6	HN 5-6	M 4	4,2
M 35x1,5	53	58	57	22	6	2,5	120	0,24	KMD 7	HN 8-9	M 4	4,2
M 40x1,5	58	63	62	22	6	2,5	130	0,27	KMD 8	HN 8-9	M 4	4,2
M 45x1,5	66,5	71,5	70,5	22	7	3	150	0,36	KMD 9	HN 10-11	M 4	4,2
M 50x1,5	70	75	74	25	7	3	200	0,41	KMD 10	HN 10-11	M 4	4,2
M 55x2	75	80	79	25	7	3	160	0,46	KMD 11 P	HN 12-13	M 4	4,2
M 60x2	80	85	84	26	7	3	175	0,5	KMD 12 P	HN 12-13	M 4	4,2
M 65x2	85	90	89	28	8	3,5	295	0,63	KMD 13	HN 14	M 5	8,4
M 70x2	90	95	94	28	8	3,5	320	0,67	KMD 14	HN 14	M 5	8,4
M 75x2	95	100	99	28	8	3,5	340	0,72	KMD 15	HN 15	M 5	8,4
M 80x2	105	110	109	32	8	3,5	445	1,05	KMD 16	HN 17	M 6	14,2
M 85x2	110	115	114	32	10	4	470	1,2	KMD 17	HN 17	M 6	14,2
M 90x2	115	120	119	32	10	4	500	1,2	KMD 18	HN 18-20	M 6	14,2
M 95x2	120	125	124	32	10	4	525	1,25	KMD 19	HN 18-20	M 6	14,2
M 100x2	125	130	129	32	10	4	555	1,3	KMD 20	HN 18-20	M 6	14,2
M 105x2	130	135	134	32	10	4	580	1,35	KMD 21	HN 18-20	M 6	14,2



SKF GB 3008

Gauges

GRA 30 ring gauges	393
Measuring options	393
Tapered seat dimensions	393
8.1 Product table	394
DMB taper gauges	396
Measuring	396
Accuracy	396
8.2 Product table	398
GB 30 and GB 10 internal clearance gauges	400
Gauging	401
Accuracy	401
8.3 Product table	402
GB 49 internal clearance gauges	404
Gauging	405
Accuracy	405
8.4 Product table	406

Gauges

Conventional measuring methods and instruments are not always suitable for checking tapered seats or measuring the inside or outside envelope diameter of the roller set of a cylindrical roller bearing in precision applications. Therefore, SKF has developed an assortment of gauges specially designed to take the accurate measurements necessary when mounting cylindrical roller bearings with a tapered bore. These gauges are also useful for other than precision applications.

Ring gauges in the GRA 30 series and DMB taper gauges (→ **page 396**) can be used to check the most common tapered seats. A GRA ring gauge can only be used to check a tapered seat for a particular bearing size. DMB taper gauges, however, can be used for a range of diameters, as well as for tapers other than 1:12.

To precisely adjust the radial internal clearance or preload when mounting a cylindrical roller bearing with a tapered bore, it is necessary to accurately measure the inside or outside envelope diameter of the roller set(s). SKF internal clearance gauges in the GB 30 and GB 10 series (→ **page 400**), and in the GB 49 series (→ **page 404**) enable simple and accurate measuring.

For information about other SKF measuring devices, contact the SKF application engineering service.

GRA 30 ring gauges

SKF ring gauges in the GRA 30 series (→ **fig. 1**) are typically used to check tapered shaft seats for cylindrical roller bearings in the NN 30 K series. Shaft seats for bearings in the NNU 49 BK and the N 10 K series can also be checked with a GRA 30 series gauge.

GRA 30 ring gauges are available for tapered seats with $d \leq 200$ mm. For seats with $d > 200$ mm, SKF recommends using a taper gauge (→ *DMB taper gauges*, **page 396**). Ring gauges for $d > 200$ mm would be difficult to handle because of their weight.

Measuring options

GRA 30 ring gauges are used primarily to determine the position of the tapered seat relative to a reference surface on the shaft. The reference face of a GRA 30 ring gauge is on the side of its large bore diameter. The reference surface on the shaft may be either in front of, or behind the gauging face of the ring gauge. GRA 30 ring gauges can also be used to check whether the centreline of the tapered seat is at right angles to a reference surface on the shaft. This is achieved by measuring the distance between the reference face on the ring gauge and the reference surface on the shaft at several positions around the circumference.

Taper form errors can be detected using blue dye.

Tapered seat dimensions

SKF recommends using the tapered seat dimensions for bearings in the NN 30 K series listed in the product tables (→ **page 294**). If other dimensions or bearing series are used, the reference length B_c should always be longer than B_b , the width of the intermediate spacer ring (→ **product table, page 394**). This is necessary because the bearing will be driven up further on the seat than the ring gauge, depending on the bearing internal clearance or preload that should be achieved. Therefore, always make the reference length longer than the width of the intermediate ring at least by a value corresponding to the difference $B_c - B_b$ (→ **product table**).

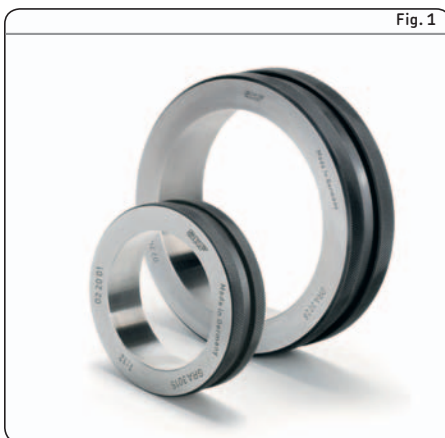
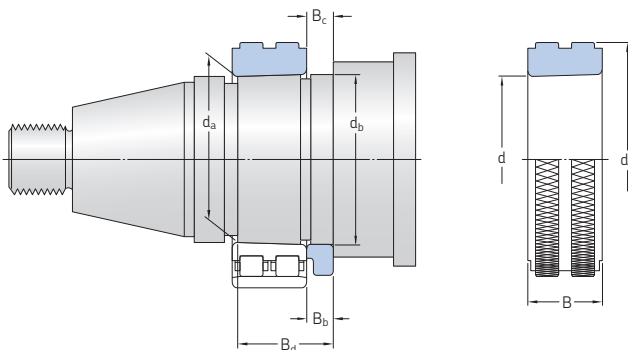

Fig. 1

8.1 GRA 30 ring gauges d 25 – 200 mm



Bearing Designation	Bearing seat Dimensions					B _d	Ring gauge Dimensions			Mass	Designation
	d _a	d _b	B _b	B _c Nom- inal	Toler- ance		d	d ₁	B		
–	mm						mm			kg	–
NN 3005 K	25,1	27	4	4,2	±0,1	19	25	46	16	0,13	GRA 3005
NN 3006 KTN	30,1	32	6	6,2	±0,1	24	30	52	19	0,18	GRA 3006
NN 3007 K	35,1	37	6	6,2	±0,1	25	35	57	20	0,21	GRA 3007
NN 3008 KTN	40,1	42	8	8,2	±0,1	28	40	62	21	0,26	GRA 3008
NN 3009 KTN	45,1	47	8	8,2	±0,1	30	45	67	23	0,31	GRA 3009
NN 3010 KTN	50,1	52	8	8,2	±0,1	30	50	72	23	0,34	GRA 3010
NN 3011 KTN	55,15	57	8	8,3	±0,12	32,5	55	77	26	0,42	GRA 3011
NN 3012 KTN	60,15	62	10	10,3	±0,12	34,5	60	82	26	0,45	GRA 3012
NN 3013 KTN	65,15	67	10	10,3	±0,12	34,5	65	88	26	0,51	GRA 3013
NN 3014 KTN	70,15	73	10	10,3	±0,12	38,5	70	95	30	0,69	GRA 3014
NN 3015 KTN	75,15	78	10	10,3	±0,12	38,5	75	100	30	0,73	GRA 3015
NN 3016 KTN	80,15	83	12	12,3	±0,12	44,5	80	105	34	0,88	GRA 3016
NN 3017 KTN9	85,2	88	12	12,4	±0,15	44	85	112	34	1	GRA 3017
NN 3018 KTN9	90,2	93	12	12,4	±0,15	47	90	120	37	1,3	GRA 3018
NN 3019 KTN9	95,2	98	12	12,4	±0,15	47	95	128	37	1,55	GRA 3019
NN 3020 KTN9	100,2	103	12	12,4	±0,15	47	100	135	37	1,7	GRA 3020
NN 3021 KTN9	105,2	109	12	12,4	±0,15	51	105	142	41	2,1	GRA 3021
NN 3022 KTN9	110,25	114	12	12,5	±0,15	54,5	110	150	45	2,6	GRA 3022
NN 3024 KTN9	120,25	124	15	15,5	±0,15	58,5	120	162	46	3,05	GRA 3024
NN 3026 KTN9	130,25	135	15	15,5	±0,15	64,5	130	175	52	3,95	GRA 3026

Bearing Designation	Bearing seat Dimensions					B _d	Ring gauge Dimensions			Mass	Designation
	d _a	d _b	B _b	B _c Nom- inal	Toler- ance		d	d ₁	B		
–	mm						mm			kg	–
NN 3028 K	140,3	145	15	15,6	±0,15	65	140	188	53	4,75	GRA 3028
NN 3030 K	150,3	155	15	15,6	±0,15	68	150	200	56	5,6	GRA 3030
NN 3032 K	160,3	165	15	15,6	±0,15	72	160	215	60	6,8	GRA 3032
NN 3034 K	170,3	176	15	15,6	±0,15	79	170	230	67	8,8	GRA 3034
NN 3036 K	180,35	187	20	20,7	±0,15	90,5	180	245	74	11,5	GRA 3036
NN 3038 K	190,35	197	20	20,7	±0,18	91,5	190	260	75	13	GRA 3038
NN 3040 K	200,35	207	20	20,7	±0,18	98,5	200	270	82	15	GRA 3040

DMB taper gauges

SKF taper gauges in the DMB series enable a quick and accurate check of the diameter and the angle of external tapers. They are suitable for final checks as well as for intermediate checks during machining. DMB taper gauges are available for tapered seats from $d = 40$ to 360 mm.

DMB taper gauges (→ **fig. 2**) consist of:

- two saddles (**a**), firmly joined together at a fixed distance
- a gauge pin (**b**), positioned in each of the saddles
- two adjustable radial stops (**c** and **d**), in each saddle at 90° intervals from the gauge pin
- an axial stop (**e**) to locate the gauge axially on the taper

The gauge pins and the radial stops can be set to measure any taper angle between 0° and 6° and any diameter within the range of the gauge. Markings on the scales show the settings for 1:12 and 1:30 tapers.

As standard, DMB taper gauges are supplied together with two dial indicators. Tailored reference tapers can be supplied on request.

Measuring

Set the radial stops and straight edges of the gauge pins to the desired diameter and taper angle, using the scales. Then, adjust the axial stop on the taper to be measured. Put the gauge on a reference taper and set the dials to zero. The gauge is now ready to take measurements.

To take a measurement, put the DMB taper gauge on the taper to be measured, making sure that it is up against the axial stop. Then take a reading. The readings on the dials are the diameter deviations. A difference in the readings between the two dials indicates a deviation in the taper angle.

While measuring, the gauge should be inclined at about 10° from the horizontal plane (→ **fig. 3**). In this position, the gauge is located on the taper by the radial and axial stops.

Accuracy

The measuring accuracy of DMB taper gauges is within $1 \mu\text{m}$ for $d < 280$ mm and within $1,5 \mu\text{m}$ for $d \geq 280$ mm.

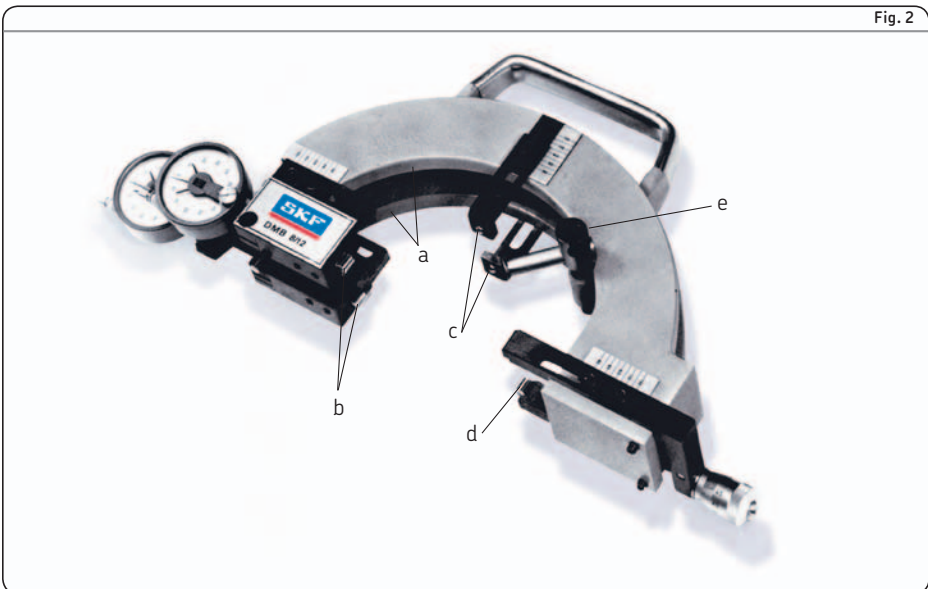
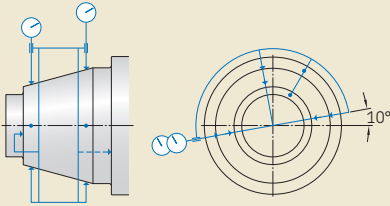
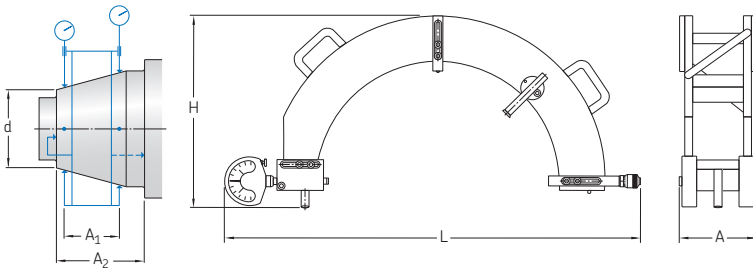

Fig. 3



8.2 DMB taper gauges

d 40 – 360 mm



Taper Diameter		Taper gauge Dimensions					Mass	Designation
d from	to	A	A ₁	A ₂	H	L		
mm		mm					kg	-
40	55	36	18	28	140	320	2,5	DMB 4/5,5
50	85	38	20	30	160	350	2,5	DMB 5/8,5
80	120	48	30	40	190	380	3	DMB 8/12
120	160	58	40	50	190	425	3,5	DMB 12/16
160	200	74	50	64	190	465	4,5	DMB 16/20
200	240	84	60	74	215	505	5,5	DMB 20/24
240	280	99	75	89	240	540	7	DMB 24/28
280	320	114	90	104	265	590	8,5	DMB 28/30
320	360	114	90	104	290	640	10	DMB 32/36

GB 30 and GB 10 internal clearance gauges

SKF internal clearance gauges in the GB 30 and GB 10 series are designed for use with double row cylindrical roller bearings ranging from NN 3006 K to NN 3068 K (GB 30 gauges) and for use with single row cylindrical roller bearings ranging from N 1010 K to NN 1020 K (GB 10 gauges). In general, gauges in the GB 30 series can also be used for single row bearings in the N 10 K series. GB 30 and GB 10 internal clearance gauges are able to accurately measure the outside envelope diameter of the roller set when the rollers are in contact with the inner ring raceway.

Depending on their size, GB 30 and GB 10 internal clearance gauges consist of either a two piece or a slotted gauge body that holds two diametrically opposed ground gauging zones (→ **fig. 4**). The gauge body can be expanded by means of an adjustment screw. This enables the gauge to be pushed over the

inner ring with roller and cage assembly, without damaging the rollers or the gauging zones. The gauging zone that is connected to one half of the gauge body transmits the diameter measured by both gauging zones to a dial indicator.



Gauging

The typical gauging procedure:

- 1** Set a bore gauge to the raceway diameter of the mounted outer ring and zero the dial indicator.
- 2** Place the bore gauge in the centre of the gauging zone of the GB 30 or GB 10 gauge. Adjust the GB 30 or GB 10 gauge until the bore gauge indicates zero minus the correction value listed in the GB 30 or GB 10 user instructions.
- 3** Further adjust the GB 30 or GB 10 gauge by increasing the gauge dimension by the value of the desired preload or reduce it by the desired clearance. Zero the dial indicator on the GB 30 or GB 10.
- 4** Place the bearing inner ring and roller set assembly onto the tapered shaft seat. Place the GB 30 or GB 10 gauge over the rollers and drive the inner ring up on the tapered seat until the dial indicator on the GB 30 or GB 10 reads zero.

For additional information, refer to *Mounting* on **page 280**.

Accuracy

The accuracy of GB 30 and GB 10 gauges is within 1 µm for sizes ≤ 20 (GB 3006 to GB 3020 and GB 1010 to GB 1020) and within 2 µm for sizes ≥ 21 (GB 3021 to GB 3068).

8.3 GB 30 and GB 10 internal clearance gauges for cylindrical roller bearings NN 3006 KTN – NN 3068 K N 1010 K – N 1020 K

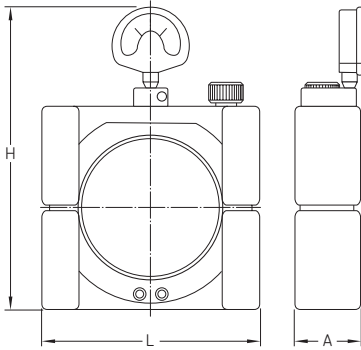

GB 3006 ... GB 3020
 GB 1010 ... GB 1020

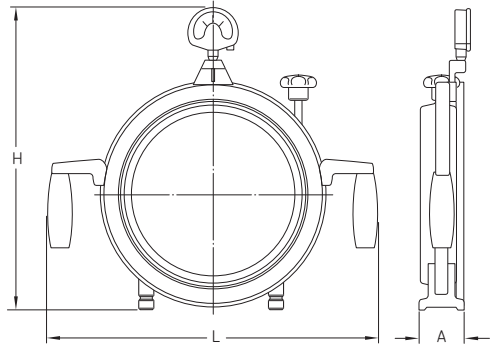

GB 3021 ... GB 3068

Bearing Designation	Internal clearance gauge Dimensions			Mass	Designation
	L	H	A		
–	mm			kg	–
NN 3006 KTN	107	175	36	2	GB 3006
NN 3007 K	112	180	37	2	GB 3007
NN 3008 KTN	117	185	39	2	GB 3008
NN 3009 KTN	129	197	40	2,5	GB 3009
NN 3010 KTN	134	202	40	2,5	GB 3010
N 1010 K	134	207	33	2	GB 1010
NN 3011 KTN	144	212	43	3,5	GB 3011
N 1011 K	144	217	35	2,3	GB 1011
NN 3012 KTN	152	222	44	4	GB 3012
N 1012 K	152	225	36	2,7	GB 1012
NN 3013 KTN	157	225	44	4	GB 3013
N 1013 K	157	230	36	3	GB 1013
NN 3014 KTN	164	232	48	5	GB 3014
N 1014 K	164	237	38	3,2	GB 1014
NN 3015 KTN	168	236	48	5	GB 3015
N 1015 K	168	241	38	3,4	GB 1015
NN 3016 KTN	176	244	52	6	GB 3016
N 1016 K	176	249	40	4	GB 1016
NN 3017 KTN9	185	253	53	6,5	GB 3017
N 1017 K	185	258	41	4,5	GB 1017
NN 3018 KTN9	198	266	56	8	GB 3018
N 1018 K	198	271	43	5,5	GB 1018
NN 3019 KTN9	203	271	56	9	GB 3019
N 1019 K	203	276	43	5,8	GB 1019
NN 3020 KTN9	212	280	56	9	GB 3020
N 1020 K	212	285	43	6,5	GB 1020

Bearing Designation	Internal clearance gauge Dimensions			Mass	Designation
	L	H	A		
–	mm			kg	–
NN 3021 KTN9	322	350	46	10,5	GB 3021
NN 3022 KTN9	332	362	46	11	GB 3022
NN 3024 KTN9	342	376	48	12	GB 3024
NN 3026 KTN9	364	396	54	13	GB 3026
NN 3028 K	378	410	54	14,5	GB 3028
NN 3030 K	391	426	58	15	GB 3030
NN 3032 K	414	446	60	16	GB 3032
NN 3034 K	430	464	62	17	GB 3034
NN 3036 K	454	490	70	17,5	GB 3036
NN 3038 K	468	504	70	18	GB 3038
NN 3040 K	488	520	74	19	GB 3040
NN 3044 K	575	514	85	26	GB 3044
NN 3048 K	605	534	87	28	GB 3048
NN 3052 K	654	580	104	41	GB 3052
NN 3056 K	680	607	106	45	GB 3056
NN 3064 K	725	640	122	60	GB 3064
NN 3068 K	738	665	122	64	GB 3068

GB 49 internal clearance gauges

SKF internal clearance gauges in the GB 49 series are designed for use with double row cylindrical roller bearings ranging from NNU 4920 BK to NNU 4960 BK. GB 49 series internal clearance gauges are able to accurately measure the internal envelope diameter of the roller set when the rollers are in contact with the outer ring raceway.

Depending on their size, GB 49 internal clearance gauges are available in two different designs (→ fig. 5). They have a slotted gauge body, so that both gauging ring halves can be brought to bear on the roller set with the appropriate pressure, as a result of the inherent resilience of the material. The outside cylindrical surface of the gauging ring has two diametrically opposed ground gauging zones. The gauge body can be compressed by means of an adjustment screw. This enables the gauge to be positioned inside the roller set

without damaging the rollers or the gauging zones.

Fig. 5

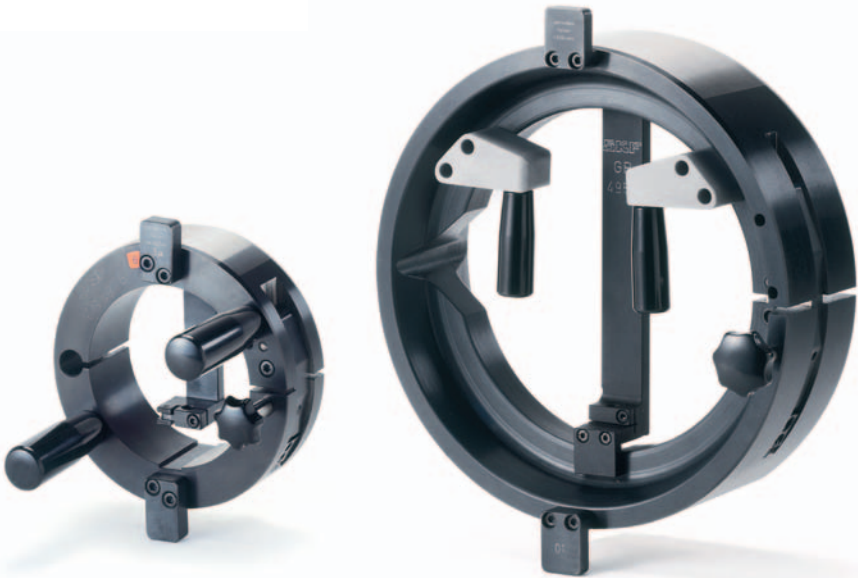

GB 4920 ... GB 4938

GB 4940 ... GB 4960

Gauging

The typical gauging procedure:

- 1 Insert the GB 49 gauge in the outer ring and roller assembly and loosen the adjustment screw until the two gauging ring halves are in contact with the roller set.
- 2 Set the dial indicator on the GB 49 gauge to zero.
- 3 Compress GB 49 using adjustment screw and remove from outer ring assembly.
- 4 Reset GB 49 so that dial indicator reads zero again using adjustment screw.
- 5 Set a stirrup gauge to GB 49 gauge diameter setting the stirrup gauge dial indicator to zero.
- 6 Drive the inner ring up onto its tapered seat monitoring the diameter expansion with the stirrup gauge until the dial indicator reads zero plus the desired preload or zero minus the desired clearance.

For additional information, refer to *Mounting* on **page 280**.

Accuracy

The accuracy of GB 49 gauges is within 1 μm for sizes ≤ 38 (GB 4920 to GB 4938) and within 2 μm for sizes ≥ 40 (GB 4940 to GB 4960).

8.4 GB 49 internal clearance gauges for cylindrical roller bearings NNU 4920 BK/SPW33 – NNU 4960 BK/SPW33

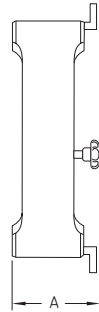
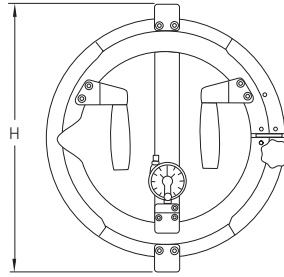
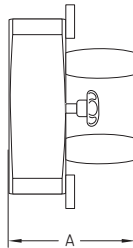
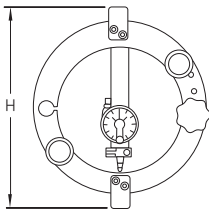

GB 4920 ... GB 4938

GB 4940 ... GB 4960

Bearing Designation	Internal clearance gauge Dimensions		Mass	Designation
	A	H		
–	mm		kg	–
NNU 4920 BK/SPW33	128	138	2,5	GB 4920
NNU 4921 BK/SPW33	128	143	3	GB 4921
NNU 4922 BK/SPW33	128	148	3	GB 4922
NNU 4924 BK/SPW33	133	162	3,5	GB 4924
NNU 4926 BK/SPW33	138	176	4	GB 4926
NNU 4928 BK/SPW33	138	186	4,5	GB 4928
NNU 4930 BK/SPW33	148	204	6	GB 4930
NNU 4932 BK/SPW33	148	212	6,5	GB 4932
NNU 4934 BK/SPW33	148	224	8	GB 4934
NNU 4936 BK/SPW33	157	237	9,5	GB 4936
NNU 4938 BK/SPW33	157	248	10,5	GB 4938
NNU 4940 BK/SPW33	105	263	12	GB 4940
NNU 4944 BK/SPW33	105	283	13	GB 4944
NNU 4948 BK/SPW33	105	303	14	GB 4948
NNU 4952 BK/SPW33	120	340	15	GB 4952
NNU 4956 BK/SPW33	120	360	17	GB 4956
NNU 4960 BK/SPW33	135	387	19	GB 4960

Indexes

Text index.....	409
Product index.....	420

Text index

A

A

- angular contact ball bearings 197
 - axial-radial cylindrical roller bearings 333
 - double direction angular contact thrust ball bearings 303, 311
 - thrust bearings for screw drives 342, 364–365
- AC** 130, 196
- ACB** 196
- accuracy
- of bearings 24–25
 - of seats and abutments 75–77, 325–326
 - of seats and abutments (for screw drives) 349
 - tolerance symbol definitions 48–49
- ACD** 196
- ACE** 196
- acrylonitrile-butadiene rubber (NBR) 56
- adapter sleeves 376
- adjusting
- angular contact ball bearings 166–172, 192
 - cylindrical roller bearings 278–279, 280–283, 392
 - precision lock nuts 380–381
- ageing 55–56, 101, 114, 125
- air flow
- effect on relubrication interval 109
 - in an external sealing arrangement 96
 - in an oil-air lubrication system 121
- aluminium thickeners 110
- ambient temperature
- considerations when selecting a grease 99
 - effect on bearing speed capability 39
- angular contact ball bearings 127–261
- adjustment during mounting 166–172, 192
 - applications 58–64, 131–132
 - assortment 128–129
 - axial displacement 31, 69, 91, 166
 - bearing arrangements 141–144
 - cages 134–135
 - contact angles 130–131
 - designation system 196–197
 - designs and variants 21, 128–141
 - dimension series 27, 129, 130
 - dimension standards 146
 - direct oil-air lubrication variants 120, 136–140
 - dismounting 124
 - equivalent bearing loads 190–191
 - fits 71–74
 - fitting and clamping bearing rings 183–189
 - high-capacity bearings 129, 131
 - high-speed design bearings 129, 132
 - hybrid bearings 133, 141, 167, 198–261
 - initial grease fill 101–102, 105
 - lifting forces 91–92
 - load carrying capacity 30, 189
 - location 183–189
 - lubrication (grease) 99–112, 136, 192
 - lubrication (oil) 113–122, 136–140, 192
 - markings 145, 194
 - matched sets 141–144
 - mounted with spacer rings 166–172, 192–193
 - mounting 123, 136, 145, 194
 - oil nozzle positions 118, 199–261
 - ordering possibilities 141
 - preload 50, 69, 90–93, 151–172
 - product table 198–261
 - reference grease quantities 102, 199–261
 - relubrication intervals 106–109
 - reuse 124
 - sealed bearings 136, 192
 - speeds 28–29, 38–40, 42, 192–193
 - spring-loaded 64, 90, 93, 165, 190
 - stiffness 67–69, 173–182
 - temperature limits 136
 - temperature rise as a function of speed 38
 - tolerance classes and tolerances 24, 146–150
 - universally matchable bearings 141–144, 194
 - with NitroMax steel rings 52–53, 141
- angular contact thrust ball bearings
- cartridge units (for screw drives) 342–343, 372–373
 - designs and variants 21–22
 - double direction bearings 301–317
 - double direction bearings (for screw drives) 341, 368–371
 - single direction bearings (for screw drives) 340, 366–367
- angularity 76
- anhydrous hydrofluorides 56
- annular grooves
- in angular contact ball bearings 120, 136–140
 - in cylindrical roller bearings 266
 - in double direction angular contact thrust ball bearings 303–304
 - in shafts 96–97
 - in thrust bearings for screw drives 341
- applications
- for angular contact ball bearings 58–64, 131–132
 - for axial-radial cylindrical roller bearings 320
 - for cylindrical roller bearings 57–59, 62
 - for double direction angular contact thrust ball bearings 57, 59
 - for thrust bearings for screw drives 350–351
 - machine tools 57–64
- associated components 20
- accuracy of seats and abutments 75–77, 325–326
 - accuracy of seats and abutments (for screw drives) 349
 - provisions for mounting and dismounting 88–89
- attachment bolts
- for axial-radial cylindrical roller bearings 330–332, 335
 - for thrust bearings for screw drives 371, 373
- attainable speeds 28, 44
- with grease lubrication 42–43, 45
 - with oil lubrication 40–41, 45
- axial clamping forces 184, 186–188
- axial displacement
- considerations when selecting a bearing 31
 - considerations when selecting a fit 70, 72
 - in angular contact ball bearings 31, 69, 91, 166

Note: Designation prefixes and suffixes are shown in **bold**.

Indexes

- in cylindrical roller bearings 31, 264, 269, 280
- axial drive-up 278–279, 280, 284
- axial fitting forces 184, 186–188
- axial location 78–87
 - with precision lock nuts 78, 375–389
 - with stepped sleeves 79, 80–87
- axial locking screws 377, 378, 381
- axial preload
 - in angular contact ball bearings 151–172
 - in axial-radial cylindrical roller bearings 322–323
 - in double direction angular contact thrust ball bearings 308
 - in thrust bearings for screw drives 355–357, 358
- axial stiffness
 - of angular contact ball bearings 173–182
 - of axial-radial cylindrical roller bearings 322–323
 - of cylindrical roller bearings 275–276
 - of double direction angular contact thrust ball bearings 309
 - of thrust bearings for screw drives 339, 356–359
 - of typical spindle bearing systems 67
- axial-radial cylindrical roller bearings 319–335
 - applications 320
 - associated components 324–326, 330
 - attachment bolts 330–332, 335
 - bearing damage 322
 - cages 320
 - designation system 333
 - designs and variants 22, 320
 - dimension standards 321
 - equivalent bearing loads 327
 - fits 324–326
 - friction 322–323, 330
 - load carrying capacity 30, 322, 327, 328–329
 - lubrication 320, 324
 - mounting 330–332
 - preload 322–323, 324
 - product table 334–335
 - retaining bolts 330, 335
 - running-in 324
 - stiffness 322–323
 - storage 330
 - temperature limits 324
 - tightening torques 332
 - tolerance classes and tolerances 24, 321
 - transport 330
 - unloading forces 322–323

B

- B**
 - angular contact ball bearings 196–197
 - axial-radial cylindrical roller bearings 333
 - cylindrical roller bearings 286
 - double direction angular contact thrust ball bearings 303, 311
 - thrust bearings for screw drives 365
- back-to-back arrangements
 - with angular contact ball bearings 142–144
 - with double direction angular contact thrust ball bearings 303
 - with thrust bearings for screw drives 341, 342–343, 346–348
- ball screw support bearings → thrust bearings for screw drives
- barium thickeners 110
- base oil viscosity → viscosity
- basic dynamic load rating 33
- basic rating life 34
- basic static load rating 36
- bearing damage
 - contamination 124
 - creep 70
 - false brinelling 100
 - fracture 52
 - skid smearing 133, 268, 304, 322
- bearing systems 57
- black-oxide 342
- blue dye 393

- boat gyrostabilizers 131
- bolt mounting
 - with cartridge units (for screw drives) 342–343, 372–373
 - with double direction bearings (for screw drives) 341, 370–371
- bolts
 - attachment bolts 330–332, 335, 371, 373
 - retaining bolts 330, 335
- bore gauges 282, 401
- boring machines 131
- brass
 - cages in angular contact ball bearings 134–135
 - cages in cylindrical roller bearings 265, 267
 - cages in double direction angular contact thrust ball bearings 304–305
 - material properties 55

C

- C**
 - angular contact ball bearings 130, 196–197
 - double direction angular contact thrust ball bearings 311
 - thrust bearings for screw drives 364
- C2** 273, 286
- C3** 273, 286
- cages
 - function 23
 - in angular contact ball bearings 134–135
 - in axial-radial cylindrical roller bearings 320
 - in cylindrical roller bearings 264, 267, 268, 280
 - in double direction angular contact thrust ball bearings 304–305
 - in thrust bearings for screw drives 344
 - materials 51, 55
- calcium thickeners
 - compatibility 110
 - considerations when selecting a grease 99–100
- car wheels → racing car wheels
- carbon fibre reinforced cages 55
 - in angular contact ball bearings 134–135
 - in cylindrical roller bearings 264, 267
- cartridge units 342–343, 372–373
 - applications 350–351
 - compared to other bearings for screw drives 339
 - designation system 364–365
 - designs and variants 22, 342–343
 - dimension standards 353
 - frictional moment 359–360
 - location 342
 - preload 355
 - product table 372–373
 - sealing solutions 344–345
 - speeds 344, 363
 - stiffness 358–359
 - surface treatment 342
 - temperature limits 344–345
 - tolerance classes and tolerances 353–354
- CB** 196
- CD** 196
- CE** 196
- centrifugal forces
 - in angular contact ball bearings 132, 162, 166, 167
 - in hybrid bearings 34, 37
- ceramics 54
- chamfer dimensions 46–47
 - maximum chamfer dimension limits 47, 50
 - tolerance symbol definitions 48
- churning 111, 113
- circulating oil 113, 114, 121
- clay 110
- clearance
 - in housing seats 30, 74, 302
 - internal clearance 50–51
- CN** 273, 286

Note: Designation prefixes and suffixes are shown in **bold**.

CNC lathe spindles 57–58
 coefficient of thermal expansion
 effect on preload 162
 of NitroMax steel 53
 of silicon nitride versus steel 54
 collars → spacer sleeves
 collectors 96–97
 consistency grades → NLGI consistency grades
 contact angles
 effect on lifting force 91–92
 effect on load carrying capacity 30
 effect on speed capability 30
 effect on stiffness 26, 68–69
 in angular contact ball bearings 130–131
 in double direction angular contact thrust ball bearings 303
 in thrust bearings for screw drives 340–341
 contact seals
 in external sealing arrangements 98
 in thrust bearings for screw drives 32, 344–345
 contamination
 bearing damage 124
 effect on relubrication interval 109
 ISO oil contamination levels 122
 protection prior to / during mounting 123, 125
 protection with grease 99
 protection with oil 114, 116
 protection with seals 32, 95–98
 coolants 23, 51, 122
 cooling 39, 99, 113, 116
 corrosion resistance
 of NitroMax steel 52–53
 protection prior to mounting 125
 protection with grease 100–101
 cotton fabric reinforced cages 55
 in angular contact ball bearings 134–135
 creep 70
 cross-sectional height
 considerations when selecting a bearing 27
 effect on speed capability 38
 cutting fluids 96, 106, 122
 cyclic operation 35, 106
 cylindrical roller bearings 263–299
 adjustment during mounting 278–279, 280–283, 392
 applications 57–59, 62
 axial displacement 31, 264, 269, 280
 axial drive-up 278–279, 280, 284
 cages 264, 267, 268, 280
 design considerations 278–280
 designation system 286
 designs and variants 21, 264–268
 dimension standards 269
 dismounting 124
 double row bearings 265–267, 294–299
 equivalent bearing loads 277
 finish-grinding allowances 267
 fits 71–72, 74
 flanges 264
 gauges for checking tapered seats 391–407
 hybrid bearings 268, 288–293
 identification numbers 273, 280
 in combination with double direction bearings 302–303
 initial grease fill 101, 103, 105
 internal clearance 273–274, 275, 278–279
 load carrying capacity 30
 lubrication features 266, 268
 markings 273, 280
 mounted with spacer rings 78, 282–285
 mounting 278–279, 280–285, 401, 405
 oil nozzle positions 119, 266, 289–299
 preload 50–51, 94, 275, 278
 product tables 288–299
 reference grease quantities 103, 289–299
 relubrication 106–109, 266
 reuse 124
 single row bearings 264, 288–293
 speeds 28, 40, 42, 264, 268, 277

stiffness 275–276
 temperature rise as a function of speed 38
 tolerance classes and tolerances 24, 269–272
 with a pre-ground raceway 267
 with a tapered bore 264–265, 272

D

D 196–197

DB

angular contact ball bearings 144, 197
 double direction angular contact thrust ball bearings 311
 thrust bearings for screw drives 342–343, 348, 365

DBA 308, 310, 311

DBB 308, 310, 311

deflection 66, 68

density 37, 54

designation systems

 for angular contact ball bearings 196–197
 for axial-radial cylindrical roller bearings 333
 for cylindrical roller bearings 286
 for double direction angular contact thrust ball bearings 311
 for precision lock nuts 382
 for thrust bearings for screw drives 364–365

DF

angular contact ball bearings 144, 197
 thrust bearings for screw drives 342–343, 348, 365

dial indicators

 on internal clearance gauges 282–284, 400–401

 on taper gauges 396

 diameter series → ISO diameter series

 dielectric strength 54

 dimension series → ISO dimension series

 dimension standards 46

 dimensional accuracy

 of bearings 24–25

 of seats and abutments 71–74, 325–326

 of seats and abutments (for screw drives) 349

 tolerance symbol definitions 48–49

 dimensional stability → heat stabilization

 direct oil-air lubrication 120

 bearing variants and dimensions 136–140

dismounting 123–124

 angular contact ball bearings 124

 cylindrical roller bearings 124

 design considerations 88–89

 thrust bearings for screw drives 341

dismounting fluids 87

distance rings 278

distance sleeves 86

double direction angular contact thrust ball bearings 301–317

 applications 57, 59

 basic design bearings 302–303, 312–317

 cages 304–305

 contact angles 303

 designation system 311

 designs and variants 21–22, 302–305

 dimension standards 306

 equivalent bearing loads 310

 fits 71–72, 74, 308

 high-speed design bearings 302–303, 312–317

 hybrid bearings 304, 312–317

 identification/serial numbers 305

 in combination with cylindrical roller bearings 302–303

 initial grease fill 101, 104–105

 lifting forces 94

 load carrying capacity 30

 lubrication (oil) 116–117, 119

 lubrication features 303–304

 markings 305

 mounting 123, 305, 310

 oil nozzle positions 119, 313–317

 preload 50, 94, 308

 product tables 312–317

Note: Designation prefixes and suffixes are shown in **bold**.

Indexes

radial clearance in the housing 30, 74, 302
reference grease quantities 104, 313–317
relubrication intervals 106–109
speeds 38, 41, 43, 310
stiffness 67, 309
temperature rise as a function of speed 38
tolerance classes and tolerances 24, 306–307
double direction angular contact thrust ball bearings (for screw drives) 341, 368–371
compared to other bearings for screw drives 339
designation system 364–365
dimension standards 353
for bolt mounting 341, 370–371
frictional moment 357, 360
preload 355, 357
product tables 368–371
sealed bearings 344–345
speeds 344, 363
stiffness 357–358
temperature limits 344–345
tolerance classes and tolerances 353–354
double direction bearings 301–317
for screw drives 341, 368–371
double row cylindrical roller bearings 265, 294–299
applications 57
axial displacement 264, 269, 280
axial drive-up 278–279
cages 267
compared to single row cylindrical roller bearings 264
designs and variants 21, 265–267
dimension standards 269
equivalent bearing loads 277
finish-grinding allowances 267
gauges for checking tapered seats 391–407
hybrid bearings 268
initial grease fill 101, 103, 105
internal clearance 273–274, 275, 278
mounting 280–285, 401, 405
oil nozzle positions 119, 266, 295–299
preload 275, 278
product tables 294–299
reference grease quantities 103
speeds 264, 268, 277
stiffness 275–276
tolerance classes and tolerances 24, 269–272
drainage
for oil-air lubrication 117
in a multi-stage labyrinth sealing arrangement 96–97
drilling heads 60, 131, 132, 166
drive-up → axial drive-up
DT
angular contact ball bearings 144, 197
thrust bearings for screw drives 348, 365
dust
effect on relubrication interval 109
protection prior to / during mounting 123
dynamometers 131

E

E 196
eccentric loads 327
elastic deformation 66, 68
elasto-hydrodynamic lubrication (EHL) 100
electrical resistivity 54
electro-spindles
oil cleanliness requirements 122
with angular contact ball bearings 62–64, 132
with cylindrical roller bearings 62, 264
ellipse truncation 36
end plates 183–189
envelope diameters 280, 392, 400, 404
envelope requirement → ISO envelope requirement
environmental considerations

for fluoro rubber (FKM) 56
for oil mist lubrication 115
for oil-air lubrication 116
EP additives
compatibility 55, 100
considerations for grease lubrication 99–100
considerations for oil lubrication 121
equivalent bearing loads
dynamic 33
static 36
ester oils
compatibility 109
in sealed bearings 104
esters 56
ethers 56
external seals 95–98
extreme pressure additives → EP additives

F

F 130, 196–197
face-to-face arrangements
with angular contact ball bearings 142–144
with thrust bearings for screw drives 342–343, 346–348
false brinelling 100
fatigue strength 52–53, 141
FB 196
FE 196
filtering 114, 117
finish-grinding allowances
for inner rings of cylindrical roller bearings 267
for spacer rings for angular contact ball bearings 166–172
fits
axial location 78–79
effect of surface roughness 75
effect on preload and internal clearance 50–51, 90, 94
effect on stiffness 68
for housings 72–74, 326
for shafts 71, 73–74, 325
radial location 70
FKM → fluoro rubber (FKM)
flanged housings 342–343, 372–373
fluoro rubber (FKM)
material properties 56
seals for angular contact ball bearings 136
fracture 52
friction 37
effect of preload and internal clearance 37
effect on speed capability 38–39
generated by seals 96, 98
with grease lubrication 37, 100, 111
with hybrid bearings 37
with oil lubrication 113–115
frictional losses 53, 99, 113
frictional moment
in axial-radial cylindrical roller bearings 322–323
in thrust bearings for screw drives 357, 360
with grease lubrication 111

G

G
angular contact ball bearings 142, 196
axial-radial cylindrical roller bearings 320, 324, 333
G...
angular contact ball bearings 151, 197
double direction angular contact thrust ball bearings 311
thrust bearings for screw drives 355, 364–365
GA
angular contact ball bearings 196
thrust bearings for screw drives 364
gauge blocks 282–283

Note: Designation prefixes and suffixes are shown in **bold**.

gauges 391–407
 bore gauges 282
 for mounting cylindrical roller bearings 280–283
 internal clearance gauges 280–283, 400–407
 ring gauges 393–395
 taper gauges 396–399

GB
 angular contact ball bearings 196
 thrust bearings for screw drives 364

GC 196

GD 196

geometrical accuracy
 of seats and abutments 75–77, 325–326
 of seats and abutments (for screw drives) 349

glass fibre reinforced cages
 in angular contact ball bearings 134–135
 in cylindrical roller bearings 264, 267, 268
 material properties 55

GMM 342, 365

grease fills
 effect on friction 37
 in sealed angular contact ball bearings 136
 in sealed thrust bearings for screw drives 344
 initial grease fill 101–105

grease lubrication 99–112
 attainable speeds 42–43
 compared with oil lubrication (speed capability) 45
 initial grease fill 101–105
 relubrication 106–109
 running-in 111–112
 service life 106

greases
 in sealed bearings 104
 selection criteria 99–100
 SKF greases 99
 storage 122
 thickener compatibility 110

grinding allowances → finish-grinding allowances

grinding machines 64, 93, 131, 132

grub (set) screws
 in double direction angular contact thrust ball bearings 341
 in precision lock nuts 378, 380, 384–388
 in thrust bearings for screw drives 341

H

H 120, 137–139, 197

H1 120, 137–139, 197

hammers 380

hardness

of bearing steel 51, 54

of NitroMax steel 53

of silicon nitride 54

HC

angular contact ball bearings 133, 197

double direction angular contact thrust ball bearings 304, 311

HCS 268, 286

heat stabilization 51, 53

heat treatment

of carbon chromium steel 51

of NitroMax steel 52–53

heating bearings → hot mounting

hollow shafts

fits 71

with cylindrical roller bearings 279

with stepped sleeves 81, 84

hot mounting 123–124

angular contact ball bearings 194

sealed bearings 136, 345

housing covers 79

in a multi-stage labyrinth sealing arrangement 96–97

humidity 125

hybrid bearings

angular contact ball bearings 133, 141, 167, 198–261

basic static load rating 36

cylindrical roller bearings 268, 288–293

double direction angular contact thrust ball bearings 304, 312–317

effect on relubrication interval 106–108

frictional behaviour 37

material properties 54

rating life 34

speeds 38, 40–43

with NitroMax steel rings 52–53, 141

hydraulic nuts 86

hydrocarbons 56

I

identification numbers

on cylindrical roller bearings 273, 280

on double direction angular contact thrust ball bearings 305

immersion 106

impact toughness 52–53

indexing heads 320

induction heaters 123

for heating sealed bearings 136, 345

for mounting axial-radial cylindrical roller bearings 330

initial grease fills 101–105

injectors 116–117

installation 123–124

of precision lock nuts 379–381

of stepped sleeves 86–87, 123–124

integral seals

design considerations 98

in angular contact ball bearings 136

in thrust bearings for screw drives 344–345

types and designs 32

interference fits 71

axial location 78–79

effect on preload and internal clearance 50–51

for angular contact ball bearings 74

for cylindrical roller bearings 31, 74

for stepped sleeves 80–81, 84

radial location 70

internal clearance 50–51

effect on friction 37

in cylindrical roller bearings 273–274, 275, 278–279

internal clearance gauges 280–283, 400–407

internal grinding machines 64, 132, 165

ISO

diameter series 27, 46

dimension series 46

envelope requirement 71–72

general plans 46

oil contamination levels 122

tolerance classes 24, 73

tolerance grades 77

tolerance standards 46–47

IT tolerance grades 77

K

K 264–265, 286

ketones 55, 56

key slots 376

keyways 376

kinematic lubricant starvation 52, 264

kinematic viscosity → viscosity

L

L 120, 137–140, 197

L1 120, 139, 197

Note: Designation prefixes and suffixes are shown in **bold**.

Indexes

- labyrinth seals
 - in a multi-stage sealing arrangement 96–97
 - integral to stepped sleeves 80, 84
 - laminar rings 339, 344–345
 - lathes 57–58, 131, 166
 - life 33–35
 - lifting forces
 - for angular contact ball bearings 91–92
 - for double direction angular contact thrust ball bearings 94
 - for thrust bearings for screw drives 94, 360
 - linear springs → springs
 - lithium thickeners
 - compatibility 110
 - considerations when selecting a grease 99–100
 - in sealed bearings 104
 - live centres 59, 131
 - loads
 - considerations when selecting a bearing 30
 - effect on relubrication interval 109
 - load ratings 33–36
 - requisite minimum loads 34
 - locating/non-locating bearing systems 31
 - location
 - axial 78–87
 - radial 70–77
 - with precision lock nuts 376–377
 - with stepped sleeves 79, 80–87
 - lock nuts → precision lock nuts
 - lock washers 376
 - locking pins 376
 - loose fits 71
 - effect on stiffness 31, 68
 - for non-locating bearings 31
 - radial location 70
 - loosening torques 378
 - lubricants
 - greases 99–101, 104, 110
 - oils 121
 - storage 122
 - lubricating oils → oils
 - lubrication
 - grease 99–112
 - oil 113–122
 - lubrication holes
 - in angular contact ball bearings 120, 136–140
 - in axial-radial cylindrical roller bearings 324
 - in cylindrical roller bearings 266
 - in double direction angular contact thrust ball bearings 304
 - in thrust bearings for screw drives 341
 - lubrication intervals 117
- M**
- M**
 - angular contact ball bearings 197
 - double direction angular contact thrust ball bearings 304–305, 311
 - MA** 134, 196
 - machine tool spindles → spindles
 - machine tools
 - applications 57–64, 131–132
 - considerations when selecting a bearing 23–32
 - machining centres
 - with angular contact ball bearings 62–63, 131–132, 141, 166
 - with axial-radial cylindrical roller bearings 320
 - with cylindrical roller bearings 62
 - markings
 - on angular contact ball bearings 145, 194
 - on cylindrical roller bearings 273, 280
 - on double direction angular contact thrust ball bearings 305
 - on thrust bearings for screw drives 352
 - matched sets
 - of angular contact ball bearings 141–144
 - of thrust bearings for screw drives 340, 346–348
 - materials 51–56
 - for bearings 51–54
 - for cages 55
 - for precision lock nuts 378
 - for seals 56
 - measuring systems 131
 - medical equipment 131
 - metal cutting machines 57–63, 132
 - metal-to-metal contact 113
 - microturbines 131
 - milling machines 59, 62–63, 131–132, 141, 166
 - mineral acids 56
 - mineral oils 56, 99
 - compatibility 109
 - minimum load 34
 - minimum quantity lubrication (MQL)
 - with oil-air lubrication 116
 - with SKF Mircrodosage system 121
 - misalignment 75
 - in thrust bearings for screw drives 346
 - miscibility 109–110
 - modulus of elasticity 54
 - moisture
 - effect on lubricant properties 122
 - effect on relubrication interval 109
 - protection prior to / during mounting 123
 - protection with grease 99
 - protection with seals 95
 - moment loads
 - on angular contact ball bearings 142, 167
 - on axial-radial cylindrical roller bearings 327, 328–329
 - on thrust bearings for screw drives 346
 - moment stiffness 323
 - motorized spindles → electro-spindles
 - mounting 123–124
 - angular contact ball bearings 136, 145, 194
 - axial-radial cylindrical roller bearings 330–332
 - cylindrical roller bearings 280–285
 - design considerations 88–89
 - double direction angular contact thrust ball bearings 305, 310
 - precision lock nuts 379–381
 - stepped sleeves 86–87
 - thrust bearings for screw drives 339, 345, 352, 362
 - mounting fluids 87
 - multi-spindle heads 320

N

- NBR → acrylonitrile-butadiene rubber (NBR)
- needle roller bearings 347
- NitroMax steel 52–53
 - in hybrid angular contact ball bearings 141
- NLGI consistency grades 99
- non-contact seals
 - in angular contact ball bearings 32, 136
 - in external sealing arrangements 96–97
 - in thrust bearings for screw drives 32, 344–345

O

- oil bath 114
 - attainable speeds 44
 - oil change intervals 121
- oil distribution grooves 89
- oil drop 115
- oil flow rates 113–114
- oil injection method
 - dimensions for ducts, grooves and holes 88–89
 - equipment and pressure media 87
 - for cylindrical roller bearings 285
 - for stepped sleeves 80, 86–87

Note: Designation prefixes and suffixes are shown in **bold**.

oil jet 115
 attainable speeds 44
 lubricating oils 121

oil lubrication 113–122
 compared with grease lubrication (speed capability) 45
 contamination levels 122
 effect on temperature and frictional losses 113
 lubricating oils 121

oil mist 115
 attainable speeds 44
 lubricating oils 121

oil nozzles 116–117
 for angular contact ball bearings 118, 199–261
 for cylindrical roller bearings 119, 266, 289–299
 for double direction angular contact thrust ball bearings 119, 313–317

oil supply ducts 89

oil-air 116–121
 attainable speeds 40–41, 44
 direct oil-air lubrication 120, 136–140
 effect on bearing temperature and frictional losses 113
 lubricating oils 121

oils 121
 oil-spot → oil-air

open bearings
 initial grease fill 101–105
 shelf life 125

open flames 56

operating temperatures 37
 as a function of oil quantity 113
 as a function of speed 38
 during running-in 112, 124
 effect on preload and internal clearance 37
 effect on relubrication interval 109
 of cage materials 55
 of seal materials 56

O-rings
 in stepped sleeves 81, 83
 on angular contact ball bearings 120, 136–140

oscillations
 considerations when selecting a grease 99
 with axial-radial cylindrical roller bearings 328

osculation 26, 131, 132

overhung shafts 346–347, 350–351

ozone 56

P

P 378, 382
P2 197
P4 197
P4A 197
P4C 311
 PA66 → polyamide 66 (PA66)
PA9A 197
 PAO 104
 Parallel Kinematic Machines (PKM) 131
PBC 197
PBT 197
 PCB drilling machines 132
PE 341, 365
 PEEK → polyetheretherketone (PEEK)
 permissible speeds 39
PFC 197
PFT 197
PG 197
PHA 264, 267, 268, 286
 phenolic resin
 cages in angular contact ball bearings 134–135
 material properties 55
 pin wrenches 379
 polishing machines 131
 polyamide 66 (PA66)
 cages in cylindrical roller bearings 264, 267
 material properties 55
 polyetheretherketone (PEEK)
 cages in angular contact ball bearings 134–135
 material properties 55
 polyglycol 109
 polymers
 cages in angular contact ball bearings 134–135
 cages in cylindrical roller bearings 264, 267, 268, 280
 material properties 55–56
 polyphenylether 109
 polyurea 110
 precision
 of bearings 24–25
 of seats and abutments 75–77, 325–326
 of seats and abutments (for screw drives) 349
 precision lock nuts 78, 375–389
 adjustment during mounting 380–381
 compared with stepped sleeves 79
 designation system 382
 designs 376–377
 dimension standards 378
 installation 379–381
 loosening torques 378
 lubrication 378
 materials 378
 preload 376–377
 product tables 384–389
 removal 379–380
 spanners 379, 384–388
 thread standards 378
 tolerances 378
 with axial locking screws 377, 388–389
 with locking pins 376, 384–387

pre-ground raceways 267

preload 90–94
 effect on friction 37
 effect on relubrication interval 108
 effect on speed capability 64
 in angular contact ball bearings 50, 69, 90–93, 151–172
 in axial-radial cylindrical roller bearings 322–323, 324
 in cylindrical roller bearings 50–51, 94, 275, 278
 in double direction angular contact thrust ball bearings 50, 94, 308
 in precision lock nuts 376–377
 in thrust bearings for screw drives 50, 94, 341, 355–357, 358

preservatives 125

printing machines 131

protectors 381

PT 197
 PTFE 109
 pumping effects 96

Q

QBC
 angular contact ball bearings 144, 197
 thrust bearings for screw drives 342–343, 348, 365

QBT
 angular contact ball bearings 144, 197
 thrust bearings for screw drives 348, 365

QFC
 angular contact ball bearings 144, 197
 thrust bearings for screw drives 342–343, 348, 365

QFT
 angular contact ball bearings 144, 197
 thrust bearings for screw drives 348, 365

QT
 angular contact ball bearings 144, 197
 thrust bearings for screw drives 348, 365

Note: Designation prefixes and suffixes are shown in **bold**.

R

racing car wheels 131
radial clearance 30, 74, 288
radial internal clearance 50–51
 in cylindrical roller bearings 273–274, 275, 278–279
radial location 70–77
radial stiffness 68–69
 of axial-radial cylindrical roller bearings 322–323
 of cylindrical roller bearings 275–276
 of typical spindle bearing systems 67
reconditioning 125
reference grease quantities 101
 for angular contact ball bearings 102, 199–261
 for cylindrical roller bearings 103, 289–299
 for double direction angular contact thrust ball bearings 104, 313–317
 for thrust bearings for screw drives 104, 367
reliability 34–35
 effect on relubrication interval 109
relubrication
 effect on frictional moment 37
 intervals and adjustments 106–109
 of sealed bearings 32, 101
relubrication-free 101
removal
 of precision lock nuts 380
 of stepped sleeves 80–81, 87
retaining bolts 330, 335
reusing bearings 124
rigidity 66–69
 considerations when selecting a bearing 26, 27
ring gauges 393–395
robotics 131
roller and cage thrust assemblies 320
rotary tables 320, 324
rotating outer ring loads 71–72
RS 344–345, 363, 364
running accuracy
 of bearings 24–25
 of seats and abutments 75–76, 325–326
 of seats and abutments (for screw drives) 349
 tolerance symbol definitions 49
running-in 111–112
 effect of grease fill on friction 37, 101, 124
 of axial-radial cylindrical roller bearings 324
run-out → running accuracy
rust protection 100–101, 125
RZ 344–345, 363, 364

S

S 136, 196
safety factors → static safety factors
screw drive bearings → thrust bearings for screw drives
screw drives 338, 350–351
sealed bearings
 angular contact ball bearings 136, 192
 grease specifications 104
 shelf life 125
 thrust bearings for screw drives 344–345
 washing 136, 345
sealing solutions 32, 95–98
 materials 56
seats
 accuracy 75–77, 324–326
 accuracy (for screw drives) 349
 fits 70–74, 324–326
 fits (for screw drives) 349
selection criteria 20–32
semiconductor industry 61, 131
serial numbers
 on angular contact ball bearings 145
 on double direction angular contact thrust ball bearings 305
service life
 of bearings with NitroMax steel rings 52
 of grease 99, 106
 of hybrid bearings 34, 37, 52
set screws → grub (set) screws
sets
 of angular contact ball bearings 141–144
 of thrust bearings for screw drives 340, 346–348
shaft orientation
 considerations for oil-air lubrication 117
 considerations when selecting a grease 99–100
 effect on relubrication interval 109
shaft systems 20
shelf life 125
shock loads
 considerations for life calculations 35
 considerations when selecting a grease 98–99
 permissible static loads 36
 suitability of preloading with springs 93
silicon nitride (Si₃N₄)
 in hybrid angular contact ball bearings 133
 in hybrid cylindrical roller bearings 268
 in hybrid double direction angular contact thrust ball bearings 304
 material properties 54
silicon wafer chips 61
silicone-methyl 109
silicone-phenyl 109
single direction angular contact thrust ball bearings (for screw drives) 340, 366–367
 applications 350–351
 bearing arrangements 346–348
 compared to other bearings for screw drives 339
 designation system 364–365
 designs and variants 22, 340
 dimension standards 353
 frictional moment 356, 360
 in cartridge units 342–343, 372–373
 load carrying capacity 356, 361
 preload 355–356
 product table 366–367
 reference grease quantities 104, 367
 sealed bearings 344–345
 sets 340, 346–348
 speeds 344, 363
 stiffness 356, 358
 temperature limits 344–345
 tolerance classes and tolerances 24, 353–354
single direction bearings 340, 366–367
 in cartridge units 342–343, 372–373
single row cylindrical roller bearings 264, 288–293
 axial displacement 264, 269, 280
 axial drive-up 278–279
 basic design bearings 264
 cages 264, 267
 compared to double row cylindrical roller bearings 264
 designs and variants 264
 dimension standards 269
 equivalent bearing loads 277
 gauges for checking tapered seats 391–407
 high-speed design bearings 264
 hybrid bearings 268
 initial grease fill 101, 103, 105
 internal clearance 273–274, 275, 278–279
 lubrication features 268
 mounting 278–279, 401
 preload 275, 278
 product tables 288–293
 speeds 264, 268, 277
 stiffness 275–276
 tolerance classes and tolerances 24, 269–272
sintered steel 378, 382
SKF LubeSelect 100
SKF Microdosage system 121
SKF Spindle Service Centres 125, 166

Note: Designation prefixes and suffixes are shown in **bold**.

SKF Spindle Simulator 33, 358
 skidding 90–91, 322
 benefits of hybrid bearings 133, 268, 304
 sleeves
 spacer sleeves 78
 stepped sleeves 79, 80–87
 smearing 133, 268, 304
 soaps 110
 sodium thickeners 110
SP
 cylindrical roller bearings 273, 286
 double direction angular contact thrust ball bearings 311
 spacer rings
 effect on running-in of bearings 111
 for angular contact ball bearings 166–172, 192–193
 for cylindrical roller bearings 78, 282–285
 for oil-air lubrication 116
 spacer sleeves 78
 spacers → spacer rings
 spanners 379, 384–388
SPC2 273, 286
 speed factor 33
 speeds 38–45
 attainable speeds 44
 considerations when selecting a bearing 28
 for typical spindle bearing systems 45
 permissible speeds 39
 with grease lubrication 42–45
 with oil lubrication 40–41, 44–45
 Spindle Service Centres → SKF Spindle Service Centres
 Spindle Simulator → SKF Spindle Simulator
 spindles
 applications 57–64
 service 125, 166
 splash guards 96–97
 spring curves 91
 springs 64, 90, 93, 165
 stainless steels → NitroMax steel
 standalone bearings 141
 start-up
 benefits of hybrid bearings 133, 268, 304
 benefits of preload 90
 considerations when selecting a grease 100
 effect of grease fill 37
 when running in 111–112, 124
 static loads 36
 static safety factors 36
 steels 51–54
 stepped sleeves 79, 80–87
 designs 80, 84
 dimensions 81–83
 fits 80, 84
 installation 86–87, 123–124
 load carrying capacity 84–85
 material 84
 removal 87
 with O-ring 80, 81, 83
 without O-ring 80, 81–82
 stiffness 66–69
 of angular contact ball bearings 173–182
 of axial-radial cylindrical roller bearings 322–323
 of cylindrical roller bearings 275–276
 of double direction angular contact thrust ball bearings 309
 of thrust bearings for screw drives 339, 356–359
 stirrup gauges 405
 storage
 of bearings 125, 330
 of lubricants 122
 super-precision bearings
 selection criteria 20–32
 types and designs 21–22
 surface roughness 75, 77, 325–326
 surface treatments 342
 synthetic oils
 compatibility 109
 considerations when selecting a grease 99

effect on cage materials 55
 system rigidity → rigidity

T

tandem arrangements
 with angular contact ball bearings 142–144
 with thrust bearings for screw drives 346–348
 taper gauges 396–399
 tapered bores 264–265, 272
 tapered seats
 checking the accuracy with a ring gauge 393
 checking the accuracy with a taper gauge 396–397
TBT
 angular contact ball bearings 144, 197
 thrust bearings for screw drives 348, 365
 telescopes 131
 temperatures
 ambient 39
 operating 37
 test running 124
TFT
 angular contact ball bearings 144, 197
 thrust bearings for screw drives 348, 365
 thermal contraction 31
 thermal expansion 31
 effect on preload and internal clearance 50–51, 93
 of silicon nitride versus steel 54
 thickeners 110
 thin-walled rings 75, 81, 123
 threaded holes
 in double direction angular contact thrust ball bearings 355
 in housings 88
 in shafts 89
 thrust bearings
 axial-radial cylindrical roller bearings 319–335
 cartridge units (for screw drives) 342–343, 372–373
 double direction bearings 301–317
 double direction bearings (for screw drives) 341, 368–371
 single direction bearings (for screw drives) 340, 366–367
 thrust bearings for screw drives 337–373
 applications 350–351
 associated components 349
 bearing arrangements 346–348
 cages 344
 cartridge units 342–343, 372–373
 contact angles 340, 341
 designation system 364–365
 designs and variants 22, 338–345
 dimension standards 353
 dismounting 341
 double direction bearings 341, 368–372
 equivalent bearing loads 361–362
 frictional moment 339, 346–360
 initial grease fill 101, 104–105
 lifting forces 94, 360
 load carrying capacity 30, 339, 346, 361
 lubrication 99, 106, 342, 344
 markings 352
 matched sets 340, 346–348
 misalignment 346
 moment stiffness 357
 mounting 123, 339, 345, 352, 362
 non-locating bearings 347
 preload 50, 94, 355–357, 358
 reference grease quantities 104, 367
 relubrication 106–109, 341, 344
 sealed bearings 339, 344–345
 selection criteria 339
 single direction bearings 340, 366–367
 speeds 41, 43, 339, 344, 363
 stiffness 339, 356–359
 temperature limits 344–345
 tolerance classes and tolerances 24, 353–354

Note: Designation prefixes and suffixes are shown in **bold**.

Indexes

universally matchable bearings 340, 346–348, 352
washing 345
tightening torques
for locating angular contact ball bearings 183–189
for precision lock nuts 384–388
TN 264, 267, 286
TN9
cylindrical roller bearings 264, 267, 286
double direction angular contact thrust ball bearings 304–305, 311
TNHA
angular contact ball bearings 134, 196
cylindrical roller bearings 264, 267, 268, 286
tolerance classes
for bearings 24–25
for seats 71–74, 325–326
for seats (for screw drives) 349
tolerance grades → IT tolerance grades
tolerances 47
symbols and definitions 48–50
tommy bars 379
torque wrenches 380
toughness → impact toughness
transition fits 71
trial mounting 282–285
troubleshooting 124
TT
angular contact ball bearings 144, 197
thrust bearings for screw drives 348, 365
turbochargers 131

U

unit conversion table 10
universally matchable bearings
angular contact ball bearings 141–144, 194
thrust bearings for screw drives 340, 346–348, 352
unloading forces 322–323
UP
cylindrical roller bearings 286
double direction angular contact thrust ball bearings 311

V

V 141, 196
vertical shaft arrangements
applications 61, 131–132
effect on relubrication interval 109
with grease lubrication 99
with oil-air lubrication 117
with thrust bearings for screw drives 346–347
vibrations
considerations when selecting a grease 99–100
troubleshooting 124
viscosity
considerations when selecting a grease 99–100
of grease in sealed bearings 104
of lubricating oils 121
of mounting and dismantling fluids 87
VR521 286
V-shaped markings
on angular contact ball bearings 145
on double direction angular contact thrust ball bearings 305
on thrust bearings for screw drives 352
VU001 267, 286

W

W33

cylindrical roller bearings 266, 286
double direction angular contact thrust ball bearings 311
W33X 286
washing
bearings before regreasing 109
sealed bearings 32, 136, 345
water
considerations when selecting a grease 99–100
effect on lubricant shelf life 122
resistance of NBR 56
wash-out 100
wear
resistance of hybrid bearings 34
resistance of NitroMax steel 52
width series 46
woodworking machines 132

Note: Designation prefixes and suffixes are shown in **bold**.

Product index

Designation	Product	Product tables	
		No.	Page ¹⁾
70..	Angular contact ball bearings	2.1	198
70../..H	Angular contact ball bearings for direct oil-air lubrication	2.1	198
70../..H1	Angular contact ball bearings for direct oil-air lubrication	2.1	198
70../..L	Angular contact ball bearings for direct oil-air lubrication	2.1	198
70../..L1	Angular contact ball bearings for direct oil-air lubrication	2.1	198
70../HC	Hybrid angular contact ball bearings	2.1	198
70../HC..H	Hybrid angular contact ball bearings for direct oil-air lubrication	2.1	198
70../HC..H1	Hybrid angular contact ball bearings for direct oil-air lubrication	2.1	198
70../HC..L	Hybrid angular contact ball bearings for direct oil-air lubrication	2.1	198
70../HC..L1	Hybrid angular contact ball bearings for direct oil-air lubrication	2.1	198
718..	Angular contact ball bearings	2.1	198
718../HC	Hybrid angular contact ball bearings	2.1	198
719..	Angular contact ball bearings	2.1	198
719../..H	Angular contact ball bearings for direct oil-air lubrication	2.1	198
719../..H1	Angular contact ball bearings for direct oil-air lubrication	2.1	198
719../..L	Angular contact ball bearings for direct oil-air lubrication	2.1	198
719../HC	Hybrid angular contact ball bearings	2.1	198
719../HC..H	Hybrid angular contact ball bearings for direct oil-air lubrication	2.1	198
719../HC..H1	Hybrid angular contact ball bearings for direct oil-air lubrication	2.1	198
719../HC..L	Hybrid angular contact ball bearings for direct oil-air lubrication	2.1	198
72..	Angular contact ball bearings	2.1	198
72../HC	Hybrid angular contact ball bearings	2.1	198
BEAM ..	Double direction angular contact thrust ball bearings for bolt mounting	6.3	370
BEAS ..	Double direction angular contact thrust ball bearings	6.2	368
BSA 2..	Single direction angular contact thrust ball bearings	6.1	366
BSA 3..	Single direction angular contact thrust ball bearings	6.1	366
BSD ..	Single direction angular contact thrust ball bearings	6.1	366
BTM ..	Double direction angular contact thrust ball bearings	4.1	312
BTM ../HC	Hybrid double direction angular contact thrust ball bearings	4.1	312
BTW ..	Double direction angular contact thrust ball bearings	4.1	312
DMB ..	Taper gauges	8.2	398
FBSA 2..	Cartridge units with a flanged housing	6.4	372
GB 10..	Internal clearance gauges for cylindrical roller bearings	8.3	402
GB 30..	Internal clearance gauges for cylindrical roller bearings	8.3	402
GB 49..	Internal clearance gauges for cylindrical roller bearings	8.4	406
GRA 30..	Ring gauges	8.1	394
KMD ..	Precision lock nuts with axial locking screws	7.3	388
KMT ..	Precision lock nuts with locking pins	7.1	384
KMTA ..	Precision lock nuts with locking pins	7.2	386
N 10..	Single row cylindrical roller bearings	3.1	288
N 10../HC5	Hybrid single row cylindrical roller bearings	3.1	288
NN 30..	Double row cylindrical roller bearings	3.2	294
NN 30../..W33(X)	Double row cylindrical roller bearings with relubrication features	3.2	294
NNU 49..	Double row cylindrical roller bearings	3.2	294
NNU 49../..W33(X)	Double row cylindrical roller bearings with relubrication features	3.2	294
NRT ..	Axial-radial cylindrical roller bearings	5.1	334

¹⁾ Starting page of the product table

Designation	Product	Product tables	
		No.	Page ¹⁾
S70..	Sealed angular contact ball bearings	2.1	198
S70../HC	Sealed hybrid angular contact ball bearings	2.1	198
S719..	Sealed angular contact ball bearings	2.1	198
S719../HC	Sealed hybrid angular contact ball bearings	2.1	198
S72..	Sealed angular contact ball bearings	2.1	198
S72../HC	Sealed hybrid angular contact ball bearings	2.1	198

¹⁾ Starting page of the product table

