



## **PULEGGE TRAPEZOIDALI PER BUSSOLA CONICA**

V-Belt pulleys for taper bushes  
Keilriemenscheiben für spannbuchsen  
Poulies trapézoïdales à moyeu amovible  
Poleas trapezoidales para casquillos conicos

# Pulegge trapezoidali per bussola conica / V-Belt pulleys for taper bushes Keilriemenscheiben für spannbuchsen / Poulies trapézoïdales à moyeu amovible Poleas trapezoidales para casquillos cónicos

Le pulegge per cinghie trapezoidali presentate dalla S.A.T.I. nel presente catalogo sono tutte costruite secondo le tabelle ISO 4183 e DIN 2211-3.

V-belt pulleys proposed by S.A.T.I. in this catalogue are all manufactured according to ISO 4183 and DIN 2211-3 norms.

Die Keilriemenscheiben, die von S.A.T.I. in diesem Katalog dargestellt sind, sind alle nach ISO 4183 und DIN 2211-3 hergestellt worden.

Les poulies trapézoïdales présentées par la S.A.T.I. sur ce catalogue sont toutes fabriquées suivant les normes ISO 4183 et DIN 2211-3.

Las poleas para correas trapezoidales presentadas por la S.A.T.I. en el presente catálogo están todas construidas según las tablas ISO 4183 y DIN 2211-3.

Il materiale impiegato nella costruzione delle medesime è in ghisa EN-GJL-200 UNI EN 1561 e, successivamente alle lavorazioni meccaniche, subiscono un trattamento superficiale di FOSFATAZIONE.

The material used for the construction of these pulleys is cast iron EN-GJL-200 UNI EN 1561 and after the machining all pulleys are being PHOSPHATED.

Das fuer die Produktion verwendete Material ist Grauguss EN-GJL-200 UNI EN 1561 und nach der Bearbeitung werden alle Keilriemenscheiben PHOSPHATIERT.

Le materiel utilisé pour la fabrication des poulies est la fonte EN-GJL-200 UNI EN 1561 et après l'usinage elles sont toutes exposées à un traitement de PHOSPHATATION.

El material empleado en la construcción de las mismas es el hierro fundido EN-GJL-200 UNI EN 1561 y después de las elaboraciones mecánicas están sometidas a un tratamiento superficial de FOSFATACIÓN.

Tutte le pulegge sono equilibrate STATICAMENTE ed idonee ad un funzionamento fino alla velocità periferica di 35 m/s.

All pulleys are STATICALLY balanced and suitable for peripheral speed up to 35 m/s.

Alle Keilriemenscheiben sind STATISCH ausgewuchtet und fuer eine peripherische Betriebsgeschwindigkeit bis 35 m/s.

Toutes les poulies sont équilibrées STATIQUEMENT et propres à tourner à une vitesse périphérique jusqu'à 35 m/s.

Todas las poleas están equilibradas ESTÁTICAMENTE y son adecuadas para un funcionamiento de una velocidad de hasta 35 m/s.

La gamma proposta nel seguente catalogo, comprende: PULEGGE TRAPEZOIDALI, per bussola conica, serie ZT..... AT..... BT..... CT..... PULEGGE TRAPEZOIDALI monoblocco (con mozzo pieno) serie ZM..... AM..... BM..... CM..... PULEGGE TRAPEZOIDALI per calettatore.

The range proposed in this catalogue is the following: V-BELT PULLEYS for taper bush, series ZT..... AT..... BT..... CT..... V-BELT PULLEYS with solid hub, series ZM..... AM..... BM..... CM..... V-BELT PULLEYS for locking devices.

Die in diesem Katalog angegebene Palette ist die folgende: KEILRIEMENSCHLEIBEN fuer Spannbuchse, Serie ZT..... AT..... BT..... CT..... KEILRIEMENSCHLEIBEN ungebohrt, Serie ZM..... AM..... BM..... CM..... KEILRIEMENSCHLEIBEN fuer Spannsätze.

La gamme proposée dans ce catalogue est la suivante: POULIES TRAPEZOIDALES pour moyeu amovible, série ZT..... AT..... BT..... CT..... POULIES TRAPEZOIDALES à moyeu plein, série ZM..... AM..... BM..... CM..... POULIES TRAPEZOIDALES pour moyeu de serrage.

La gama propuesta en el siguiente catálogo comprende: POLEAS TRAPEZOIDALES para casquillos cónicos, serie ZT..... AT..... BT..... CT..... POLEAS TRAPEZOIDALES con cubo pieno, serie ZM..... AM..... BM..... CM..... POLEAS TRAPEZOIDALES para casquillos de fijación.

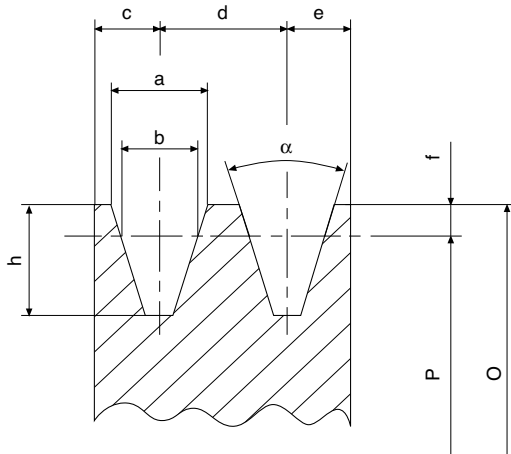

**Calcolo della velocità periferica  $V_p$  in m/s**  
**Calculation of peripheral speed  $V_p$  in m/s**  
**Berechnung der Umfangsgeschwindigkeit  $V_p$  in m/s**  
**Calcul de la vitesse périphérique  $V_p$  m/s**  
**Cálculo de la velocidad periférica  $V_p$  en m/s**

$$V_p = \frac{\pi \cdot P \cdot \text{rpm}}{60 \cdot 1000} \approx \frac{P \cdot \text{rpm}}{19100} \quad V_p \leq 35 \text{ m/s}$$

P = Diametro primitivo in mm  
Pitch diameter in mm  
Teildurchmesser in mm  
Diamètre primitif en mm  
Diámetro primitivo en mm

rpm = Giri al minuto  
Revolutions per minute  
Umdrehungen pro Minute  
Tours par minute  
Revoluciones por minuto

## Dimensioni puleggia

## Pulley dimintions

## Keilriemenscheibeabmessungen

## Dimensions poulie

## Dimensiones polea

	a	b	c	d	e	f	h	34°	38°
SPZ	9,7	8,5	8,0	12,0	8,0	2,0	11,0	P ≤ 80	P > 80
SPA	12,7	11,0	10,0	15,0	10,0	2,8	13,8	P ≤ 118	P > 118
SPB	16,3	14,0	12,5	19,0	12,5	3,5	17,5	P ≤ 190	P > 190
SPC	22,0	19,0	17,0	25,5	17,0	4,8	23,8	P ≤ 315	P > 315

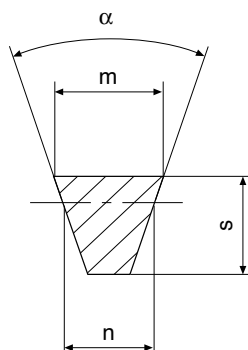

## Dimensioni cinghia / Belt dimintions / Riemenabmessungen Dimensions courroie / Dimensiones correa

	m	s	n
SPZ	9,7	8	8,5
SPA	12,7	10	11,0
SPB	16,3	13	14,0
SPC	22,0	18	19,0

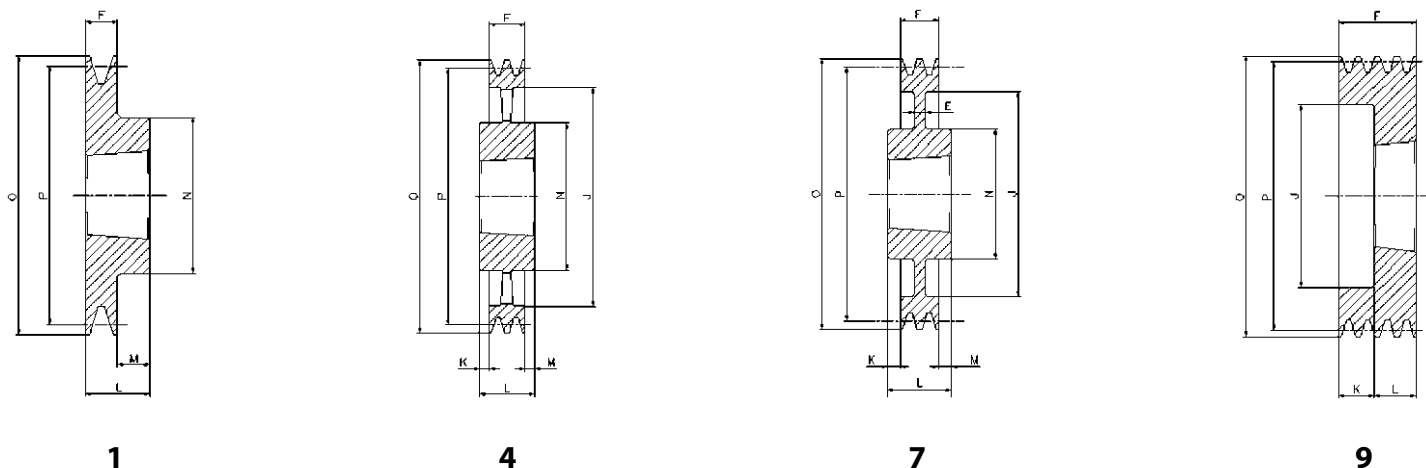

# SPZ/1

Cod. interno Internal code Innerer Code Code interne Código interno	Tipo Type Typ Type Tipo	Gole Grooves Rillen Gorges Canales	P	O	Forma Form Forme Forme Forma	Bussola Bush Buchse Moyeu Casquillo	Ø MAX	E	F	J	K	L	M	N
ZT00501	SPZ 50-01	1	<b>50</b>	54	9	1008	25	-	37	26	12,0	25	-	-
ZT00561	SPZ 56-01	1	<b>56</b>	60	9	1008	25	-	37	32	12,0	25	-	-
ZT00601	SPZ 60-01	1	<b>60</b>	64	1	1008	25	-	22	-	-	22	-	-
ZT00631	SPZ 63-01	1	<b>63</b>	67	1	1108	28	-	16	-	-	22	6,0	56
ZT00671	SPZ 67-01	1	<b>67</b>	71	1	1108	28	-	16	-	-	22	6,0	60
ZT00711	SPZ 71-01	1	<b>71</b>	75	1	1108	28	-	16	-	-	22	6,0	60
ZT00751	SPZ 75-01	1	<b>75</b>	79	1	1108	28	-	16	-	-	22	6,0	60
ZT00801	SPZ 80-01	1	<b>80</b>	84	1	1210	32	-	16	-	-	25	9,0	75
ZT00851	SPZ 85-01	1	<b>85</b>	89	1	1210	32	-	16	-	-	25	9,0	80
ZT00901	SPZ 90-01	1	<b>90</b>	94	1	1210	32	-	16	-	-	25	9,0	80
ZT00951	SPZ 95-01	1	<b>95</b>	99	1	1210	32	-	16	-	-	25	9,0	85
ZT01001	SPZ100-01	1	<b>100</b>	104	1	1210	32	-	16	-	-	25	9,0	85
ZT01061	SPZ106-01	1	<b>106</b>	110	1	1610	42	-	16	-	-	25	9,0	92
ZT01121	SPZ112-01	1	<b>112</b>	116	1	1610	42	-	16	-	-	25	9,0	92
ZT01181	SPZ118-01	1	<b>118</b>	122	1	1610	42	-	16	-	-	25	9,0	92
ZT01251	SPZ125-01	1	<b>125</b>	129	1	1610	42	-	16	-	-	25	9,0	92
ZT01321	SPZ132-01	1	<b>132</b>	136	1	1610	42	-	16	-	-	25	9,0	92
ZT01401	SPZ140-01	1	<b>140</b>	144	1	1610	42	-	16	-	-	25	9,0	92
ZT01501	SPZ150-01	1	<b>150</b>	154	1	1610	42	-	16	-	-	25	9,0	92
ZT01601	SPZ160-01	1	<b>160</b>	164	1	1610	42	-	16	-	-	25	9,0	92
ZT01701	SPZ170-01	1	<b>170</b>	174	1	1610	42	-	16	-	-	25	9,0	92
ZT01801	SPZ180-01	1	<b>180</b>	184	7	1610	42	6	16	152	-	25	9,0	92
ZT01901	SPZ190-01	1	<b>190</b>	194	7	1610	42	12	16	162	-	25	9,0	92
ZT02001	SPZ200-01	1	<b>200</b>	204	7	2012	50	10	16	171	-	32	16,0	112
ZT02241	SPZ224-01	1	<b>224</b>	228	7	2012	50	15	16	195	-	32	16,0	112
ZT02501	SPZ250-01	1	<b>250</b>	254	4	2012	50	-	16	221	8,0	32	8,0	112
ZT02801	SPZ280-01	1	<b>280</b>	284	4	2012	50	-	16	251	8,0	32	8,0	112
ZT03151	SPZ315-01	1	<b>315</b>	319	4	2012	50	-	16	286	8,0	32	8,0	112
ZT03551	SPZ355-01	1	<b>355</b>	359	4	2012	50	-	16	326	8,0	32	8,0	112
ZT04001	SPZ400-01	1	<b>400</b>	404	4	2012	50	-	16	371	8,0	32	8,0	112
ZT04501	SPZ450-01	1	<b>450</b>	454	4	2517	60	-	16	421	14,5	45	14,5	124

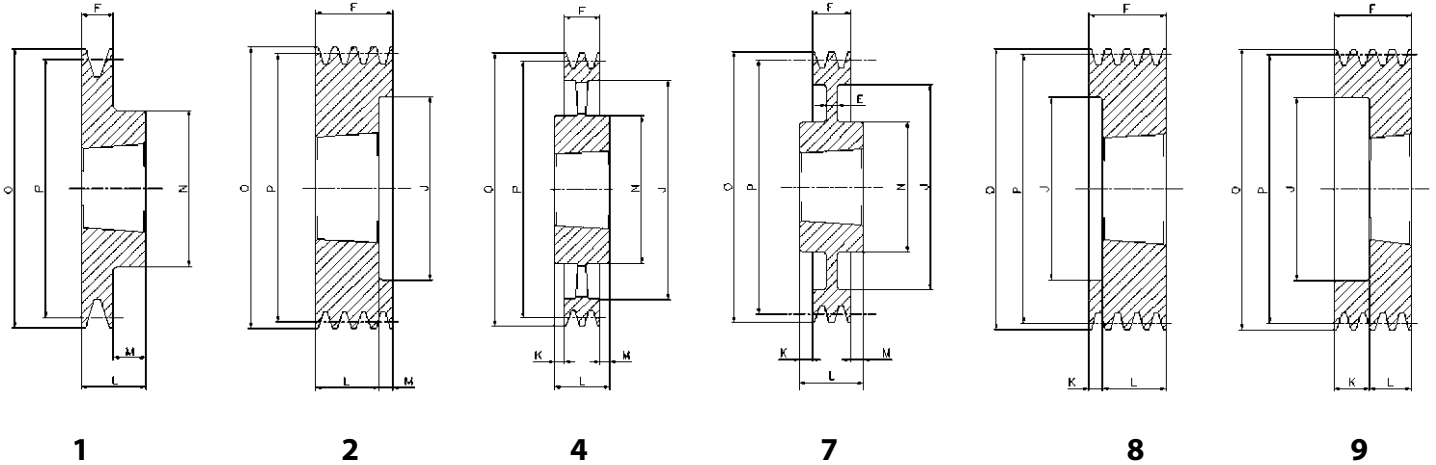

# SPZ/2

Cod. interno Internal code Innerer Code Code interne Código interno	Tipo Type Typ Type Tipo	Gole Grooves Rillen Gorges Canales	P	O	Forma Form Forme Forme Forma	Bussola Bush Buchse Moyeu Casquillo	Ø MAX	E	F	J	K	L	M	N
ZT00502	SPZ 50-02	2	<b>50</b>	54	9	1008	25	-	50	26	25,0	25	-	-
ZT00562	SPZ 56-02	2	<b>56</b>	60	9	1008	25	-	49	32	27,0	22	-	-
ZT00602	SPZ 60-02	2	<b>60</b>	64	9	1108	28	-	49	36	27,0	22	-	-
ZT00632	SPZ 63-02	2	<b>63</b>	67	8	1108	28	-	28	40	6,0	22	-	-
ZT00672	SPZ 67-02	2	<b>67</b>	71	8	1108	28	-	28	42	6,0	22	-	-
ZT00712	SPZ 71-02	2	<b>71</b>	75	8	1108	28	-	28	42	6,0	22	-	-
ZT00752	SPZ 75-02	2	<b>75</b>	79	8	1210	32	-	28	51	3,0	25	-	-
ZT00802	SPZ 80-02	2	<b>80</b>	84	8	1210	32	-	28	51	3,0	25	-	-
ZT00852	SPZ 85-02	2	<b>85</b>	89	8	1610	42	-	28	60	3,0	25	-	-
ZT00902	SPZ 90-02	2	<b>90</b>	94	8	1610	42	-	28	61	3,0	25	-	-
ZT00952	SPZ 95-02	2	<b>95</b>	99	8	1610	42	-	28	66	3,0	25	-	-
ZT01002	SPZ100-02	2	<b>100</b>	104	8	1610	42	-	28	71	3,0	25	-	-
ZT01062	SPZ106-02	2	<b>106</b>	110	8	1610	42	-	28	76	3,0	25	-	-
ZT01122	SPZ112-02	2	<b>112</b>	116	8	1610	42	-	28	83	3,0	25	-	-
ZT01182	SPZ118-02	2	<b>118</b>	122	8	1610	42	-	28	90	3,0	25	-	-
ZT01252	SPZ125-02	2	<b>125</b>	129	8	1610	42	-	28	96	3,0	25	-	-
ZT01322	SPZ132-02	2	<b>132</b>	136	8	1610	42	-	28	103	3,0	25	-	-
ZT01402	SPZ140-02	2	<b>140</b>	144	8	1610	42	-	28	111	3,0	25	-	-
ZT01502	SPZ150-02	2	<b>150</b>	154	1	2012	50	-	28	-	-	32	4,0	112
ZT01602	SPZ160-02	2	<b>160</b>	164	1	2012	50	-	28	-	-	32	4,0	112
ZT01702	SPZ170-02	2	<b>170</b>	174	1	2012	50	-	28	-	-	32	4,0	112
ZT01802	SPZ180-02	2	<b>180</b>	184	7	2012	50	6	28	152	-	32	4,0	112
ZT01902	SPZ190-02	2	<b>190</b>	194	7	2012	50	12	28	162	-	32	4,0	112
ZT02002	SPZ200-02	2	<b>200</b>	204	7	2012	50	6	28	171	-	32	4,0	112
ZT02242	SPZ224-02	2	<b>224</b>	228	4	2012	50	15	28	195	-	32	4,0	112
ZT02502	SPZ250-02	2	<b>250</b>	254	4	2012	50	-	28	221	2,0	32	2,0	112
ZT02802	SPZ280-02	2	<b>280</b>	284	4	2012	50	-	28	251	2,0	32	2,0	112
ZT03152	SPZ315-02	2	<b>315</b>	319	4	2012	50	-	28	286	2,0	32	2,0	112
ZT03552	SPZ355-02	2	<b>355</b>	359	4	2012	50	-	28	326	2,0	32	2,0	112
ZT04002	SPZ400-02	2	<b>400</b>	404	4	2517	60	-	28	371	8,5	45	8,5	124
ZT04502	SPZ450-02	2	<b>450</b>	454	4	2517	60	-	28	421	8,5	45	8,5	124

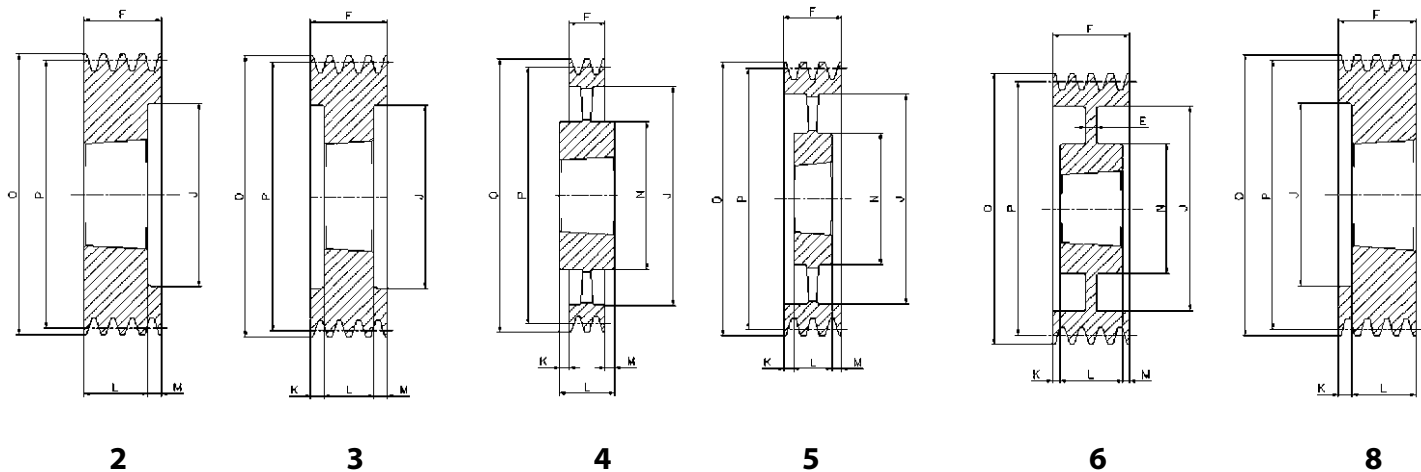

# SPZ/3

Cod. interno Internal code Innerer Code Code interne Código interno	Tipo Type Typ Type Tipo	Gole Grooves Rillen Gorges Canales	P	O	Forma Form Forme Forme Forma	Bussola Bush Buchse Moyeu Casquillo	∅ MAX	E	F	J	K	L	M	N
ZT00633	SPZ63-03	3	<b>63</b>	67	8	1108	28	-	40	40	-	22	-	-
ZT00673	SPZ67-03	3	<b>67</b>	71	8	1108	28	-	40	42	18,0	22	-	-
ZT00713	SPZ71-03	3	<b>71</b>	75	8	1108	28	-	40	42	18,0	22	-	-
ZT00753	SPZ75-03	3	<b>75</b>	79	8	1210	32	-	40	51	15,0	25	-	-
ZT00803	SPZ80-03	3	<b>80</b>	84	8	1210	32	-	40	51	15,0	25	-	-
ZT00853	SPZ85-03	3	<b>85</b>	89	8	1610	42	-	40	60	15,0	25	-	-
ZT00903	SPZ90-03	3	<b>90</b>	94	8	1610	42	-	40	61	15,0	25	-	-
ZT00953	SPZ95-03	3	<b>95</b>	99	8	1610	42	-	40	66	15,0	25	-	-
ZT01003	SPZ100-03	3	<b>100</b>	104	8	1610	42	-	40	71	15,0	25	-	-
ZT01063	SPZ106-03	3	<b>106</b>	110	8	1610	42	-	40	76	15,0	25	-	-
ZT01123	SPZ112-03	3	<b>112</b>	116	8	2012	50	-	40	83	8,0	32	-	-
ZT01183	SPZ118-03	3	<b>118</b>	122	8	2012	50	-	40	90	8,0	32	-	-
ZT01253	SPZ125-03	3	<b>125</b>	129	2	2012	50	-	40	96	-	32	8,0	-
ZT01323	SPZ132-03	3	<b>132</b>	136	2	2012	50	-	40	103	-	32	8,0	-
ZT01403	SPZ140-03	3	<b>140</b>	144	2	2012	50	-	40	111	-	32	8,0	-
ZT01503	SPZ150-03	3	<b>150</b>	154	2	2012	50	-	40	121	-	32	8,0	-
ZT01603	SPZ160-03	3	<b>160</b>	164	2	2012	50	-	40	131	-	32	8,0	-
ZT01703	SPZ170-03	3	<b>170</b>	174	3	2012	50	-	40	141	4,0	32	4,0	-
ZT01803	SPZ180-03	3	<b>180</b>	184	6	2012	50	7	40	151	-	32	8,0	106
ZT01903	SPZ190-03	3	<b>190</b>	194	6	2012	50	10	40	161	4,0	32	4,0	112
ZT02003	SPZ200-03	3	<b>200</b>	204	6	2012	50	10	40	171	4,0	32	4,0	112
ZT02243	SPZ224-03	3	<b>224</b>	228	6	2012	50	12	40	195	4,0	32	4,0	112
ZT02503	SPZ250-03	3	<b>250</b>	254	5	2012	50	-	40	221	4,0	32	4,0	112
ZT02803	SPZ280-03	3	<b>280</b>	284	4	2517	60	-	40	251	2,5	45	2,5	124
ZT03153	SPZ315-03	3	<b>315</b>	319	4	2517	60	-	40	286	2,5	45	2,5	124
ZT03553	SPZ355-03	3	<b>355</b>	359	4	2517	60	-	40	326	2,5	45	2,5	124
ZT04003	SPZ400-03	3	<b>400</b>	404	4	2517	60	-	40	371	2,5	45	2,5	124
ZT04503	SPZ450-03	3	<b>450</b>	454	4	2517	60	-	40	421	2,5	45	2,5	124
ZT05003	SPZ500-03	3	<b>500</b>	504	4	2517	60	-	40	471	2,5	45	2,5	124
ZT06303	SPZ630-03	3	<b>630</b>	634	4	3020	75	-	40	601	5,5	51	5,5	150
ZT08003	SPZ800-03	3	<b>800</b>	804	4	3020	75	-	40	771	5,5	51	5,5	146

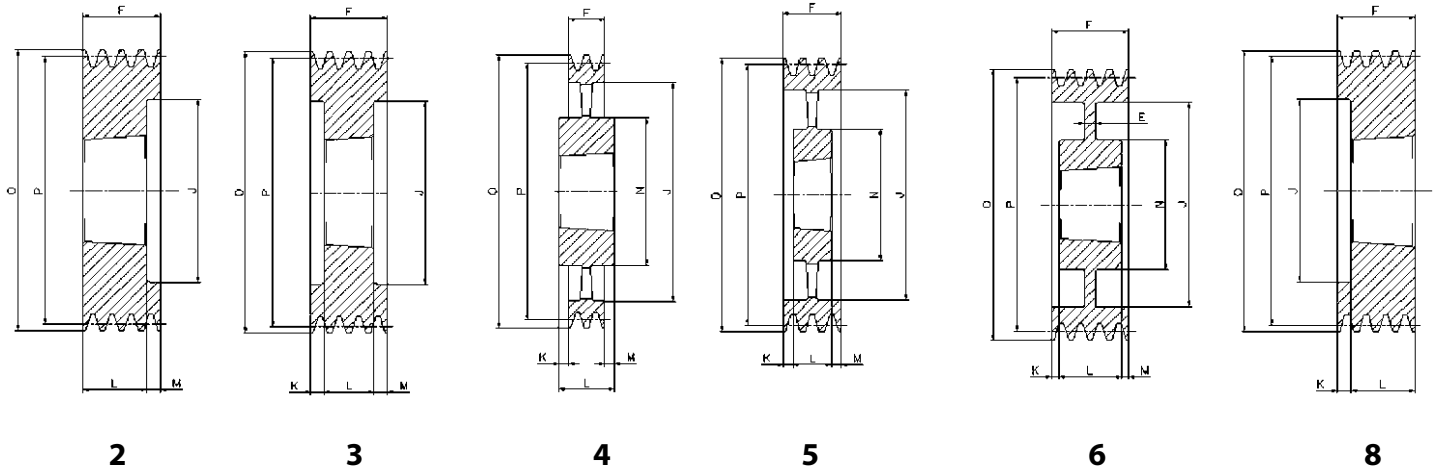

# SPZ/4

Cod. interno Internal code Innerer Code Code interne Código interno	Tipo Type Typ Type Tipo	Gole Grooves Rillen Gorges Canales	P	O	Forma Form Forme Forme Forma	Bussola Buchse Moyeu Casquillo	∅ MAX	E	F	J	K	L	M	N
ZT00804	SPZ 80-04	4	<b>80</b>	84	8	1210	32	-	52	51	27,0	25	-	-
ZT00854	SPZ 85-04	4	<b>85</b>	89	8	1610	42	-	52	60	27,0	25	-	-
ZT00904	SPZ 90-04	4	<b>90</b>	94	8	1610	42	-	52	61	27,0	25	-	-
ZT00954	SPZ 95-04	4	<b>95</b>	99	8	1610	42	-	52	66	27,0	25	-	-
ZT01004	SPZ100-04	4	<b>100</b>	104	8	1610	42	-	52	71	27,0	25	-	-
ZT01064	SPZ106-04	4	<b>106</b>	110	8	1610	42	-	52	76	27,0	25	-	-
ZT01124	SPZ112-04	4	<b>112</b>	116	8	2012	50	-	52	83	20,0	32	-	-
ZT01184	SPZ118-04	4	<b>118</b>	122	8	2012	50	-	52	90	20,0	32	-	-
ZT01254	SPZ125-04	4	<b>125</b>	129	2	2012	50	-	52	96	-	32	20,0	-
ZT01324	SPZ132-04	4	<b>132</b>	136	2	2012	50	-	52	103	-	32	20,0	-
ZT01404	SPZ140-04	4	<b>140</b>	144	2	2012	50	-	52	111	-	32	20,0	-
ZT01504	SPZ150-04	4	<b>150</b>	154	2	2517	60	-	52	121	-	45	7,0	-
ZT01604	SPZ160-04	4	<b>160</b>	164	2	2517	60	-	52	131	-	45	7,0	-
ZT01704	SPZ170-04	4	<b>170</b>	174	2	2517	60	-	52	141	-	45	7,0	-
ZT01804	SPZ180-04	4	<b>180</b>	184	2	2517	60	-	52	151	-	45	7,0	-
ZT01904	SPZ190-04	4	<b>190</b>	194	3	2517	60	-	52	161	3,5	45	3,5	-
ZT02004	SPZ200-04	4	<b>200</b>	204	6	2517	60	8	52	171	3,5	45	3,5	124
ZT02244	SPZ224-04	4	<b>224</b>	228	6	2517	60	14	52	195	3,5	45	3,5	124
ZT02504	SPZ250-04	4	<b>250</b>	254	6	2517	60	12	52	221	3,5	45	3,5	124
ZT02804	SPZ280-04	4	<b>280</b>	284	6	2517	60	14	52	251	3,5	45	3,5	124
ZT03154	SPZ315-04	4	<b>315</b>	319	5	2517	60	-	52	286	3,5	45	3,5	124
ZT03554	SPZ355-04	4	<b>355</b>	359	5	2517	60	-	52	326	3,5	45	3,5	124
ZT04004	SPZ400-04	4	<b>400</b>	404	5	2517	60	-	52	371	3,5	45	3,5	124
ZT04504	SPZ450-04	4	<b>450</b>	454	5	3020	75	-	52	421	0,5	51	0,5	146
ZT05004	SPZ500-04	4	<b>500</b>	504	5	3020	75	-	52	471	0,5	51	0,5	146
ZT06304	SPZ630-04	4	<b>630</b>	634	4	3030	75	-	52	601	12,0	76	12,0	146
ZT08004	SPZ800-04	4	<b>800</b>	804	4	3030	75	-	52	771	12,0	76	12,0	146

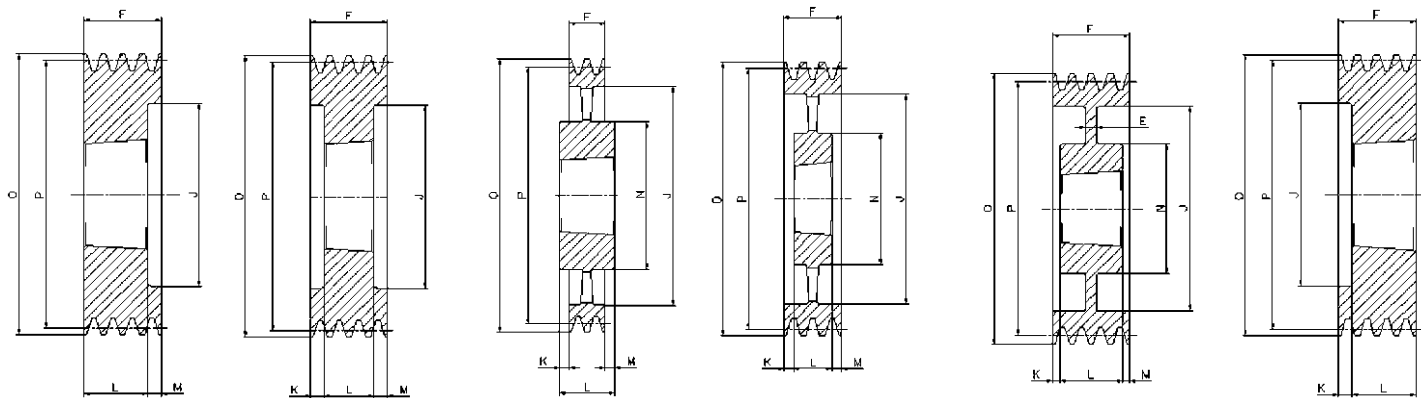

2

3

4

5

6

8

# SPZ/5

Cod. interno Internal code Inner Code Code interne Código interno	Tipo Type Typ Type Tipo	Gole Grooves Rillen Gorges Canales	P	O	Forma Form Forme Forme Forma	Bussola Bush Buchse Moyeu Casquillo	∅ MAX	E	F	J	K	L	M	N
ZT00855	SPZ 85-05	5	85	89	8	1610	42	-	64	60	39,0	25	-	-
ZT00905	SPZ 90-05	5	90	94	8	1610	42	-	64	61	39,0	25	-	-
ZT00955	SPZ 95-05	5	95	99	8	1610	42	-	64	66	39,0	25	-	-
ZT01005	SPZ100-05	5	100	104	8	2012	50	-	64	71	32,0	32	-	-
ZT01065	SPZ106-05	5	106	110	8	2012	50	-	64	76	32,0	32	-	-
ZT01125	SPZ112-05	5	112	116	8	2012	50	-	64	83	32,0	32	-	-
ZT01185	SPZ118-05	5	118	122	8	2012	50	-	64	90	32,0	32	-	-
ZT01255	SPZ125-05	5	125	129	8	2012	50	-	64	96	32,0	32	-	-
ZT01325	SPZ132-05	5	132	136	8	2517	60	-	64	103	19,0	45	19,0	-
ZT01405	SPZ140-05	5	140	144	2	2517	60	-	64	111	-	45	19,0	-
ZT01505	SPZ150-05	5	150	154	2	2517	60	-	64	121	-	45	19,0	-
ZT01605	SPZ160-05	5	160	164	2	2517	60	-	64	131	-	45	19,0	-
ZT01705	SPZ170-05	5	170	174	2	2517	60	-	64	141	-	45	19,0	-
ZT01805	SPZ180-05	5	180	184	2	2517	60	-	64	151	-	45	19,0	-
ZT01905	SPZ190-05	5	190	194	3	2517	60	-	64	161	9,5	45	9,5	-
ZT02005	SPZ200-05	5	200	204	3	2517	60	-	64	171	9,5	45	9,5	-
ZT02245	SPZ224-05	5	224	228	6	2517	60	20	64	195	9,5	45	9,5	124
ZT02505	SPZ250-05	5	250	254	6	2517	60	16	64	221	9,5	45	9,5	124
ZT02805	SPZ280-05	5	280	284	6	2517	60	15	64	251	9,5	45	9,5	124
ZT03155	SPZ315-05	5	315	319	5	2517	60	-	64	286	9,5	45	9,5	124
ZT03555	SPZ355-05	5	355	359	5	2517	60	-	64	326	9,5	45	9,5	124
ZT04005	SPZ400-05	5	400	404	5	3020	75	-	64	371	6,5	51	6,5	146
ZT04505	SPZ450-05	5	450	454	5	3020	75	-	64	421	6,5	51	6,5	146
ZT05005	SPZ500-05	5	500	504	4	3030	75	-	64	471	6,0	76	6,0	146
ZT06305	SPZ630-05	5	630	634	4	3030	75	-	64	601	6,0	76	6,0	146
ZT08005	SPZ800-05	5	800	804	4	3535	90	-	64	771	12,5	89	12,5	178

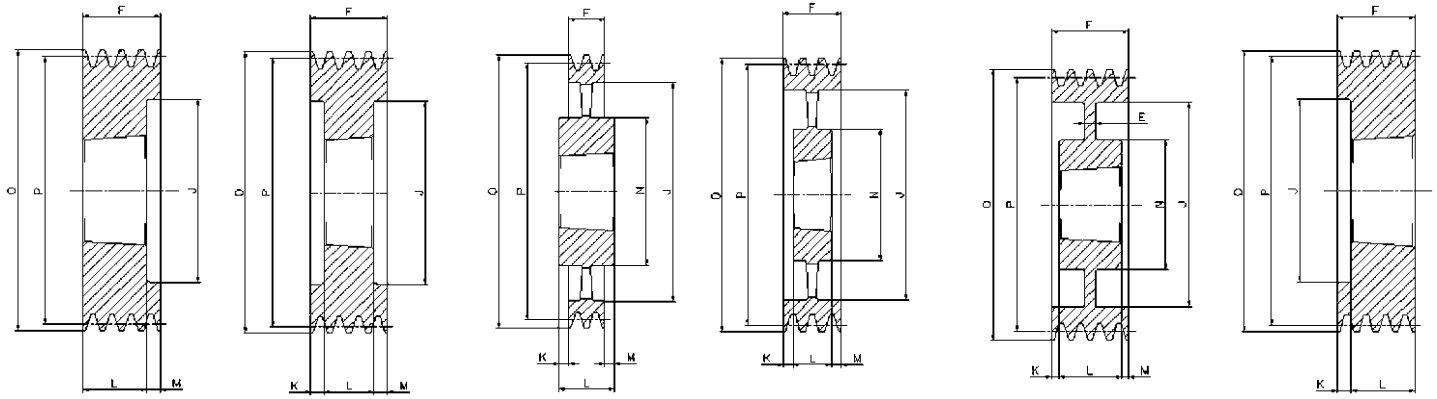

2

3

4

5

6

8

# SPZ/6

Cod. interno Internal code Innerer Code Code interne Código interno	Tipo Type Typ Type Tipo	Gole Grooves Rillen Gorges Canales	P	O	Forma Form Forme Forme Forma	Bussola Bush Buchse Moyeu Casquillo	∅ MAX	E	F	J	K	L	M	N
ZT00906	SPZ 90-06	6	90	94	8	1610	42	-	76	61	51,0	25	-	-
ZT00956	SPZ 95-06	6	95	99	8	1610	42	-	76	66	51,0	25	-	-
ZT01006	SPZ100-06	6	100	104	8	2012	50	-	76	71	44,0	32	-	-
ZT01066	SPZ106-06	6	106	110	8	2012	50	-	76	76	44,0	32	-	-
ZT01126	SPZ112-06	6	112	116	8	2012	50	-	76	83	44,0	32	-	-
ZT01186	SPZ118-06	6	118	122	8	2517	60	-	76	90	31,0	45	-	-
ZT01256	SPZ125-06	6	125	129	8	2517	60	-	76	96	31,0	45	-	-
ZT01326	SPZ132-06	6	132	136	8	2517	60	-	76	103	31,0	45	-	-
ZT01406	SPZ140-06	6	140	144	2	2517	60	-	76	111	-	45	31,0	-
ZT01506	SPZ150-06	6	150	154	2	2517	60	-	76	121	-	45	31,0	-
ZT01606	SPZ160-06	6	160	164	2	2517	60	-	76	131	-	45	31,0	-
ZT01706	SPZ170-06	6	170	174	2	2517	60	-	76	141	-	45	31,0	-
ZT01806	SPZ180-06	6	180	184	3	2517	60	-	76	151	15,5	45	15,5	-
ZT01906	SPZ190-06	6	190	194	3	2517	60	-	76	161	15,5	45	15,5	124
ZT02006	SPZ200-06	6	200	204	3	2517	60	-	76	171	15,5	45	15,5	124
ZT02246	SPZ224-06	6	224	228	6	2517	60	26	76	195	15,5	45	15,5	124
ZT02506	SPZ250-06	6	250	254	6	2517	60	26	76	221	15,5	45	15,5	124
ZT02806	SPZ280-06	6	280	284	6	2517	60	15	76	251	15,5	45	15,5	124
ZT03156	SPZ315-06	6	315	319	6	2517	60	15	76	286	15,5	45	15,5	124
ZT03556	SPZ355-06	6	355	359	5	2517	60	-	76	326	15,5	45	15,5	124
ZT04006	SPZ400-06	6	400	404	5	3030	75	-	76	371	-	76	-	146
ZT04506	SPZ450-06	6	450	454	5	3030	75	-	76	421	-	76	-	146
ZT05006	SPZ500-06	6	500	504	5	3030	75	-	76	471	-	76	-	146
ZT06306	SPZ630-06	6	630	634	4	3535	90	-	76	601	6,5	89	6,5	175
ZT08006	SPZ800-06	6	800	804	4	3535	90	-	76	771	6,5	89	6,5	178



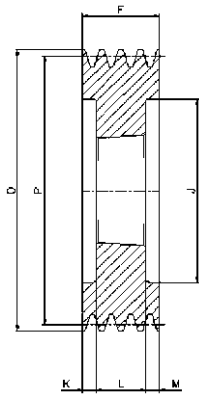

3

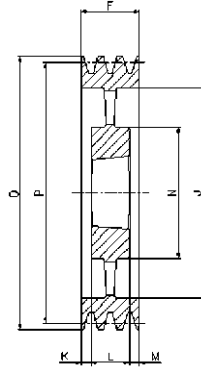

5

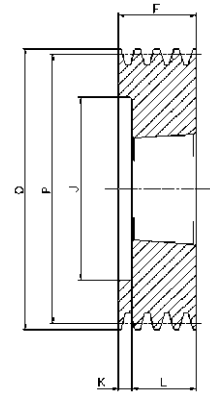

8

# SPZ/8

Cod. interno Internal code Innerer Code Code interne Código interno	Tipo Type Typ Type Tipo	Gole Grooves Rillen Gorges Canales	P	O	Forma Form Forme Forme Forma	Bussola Bush Buchse Moyeu Casquillo	∅ MAX	E	F	J	K	L	M	N
ZT01408	SPZ140-08	8	<b>140</b>	144	3	2517	60	-	100	111	27,5	45	27,5	-
ZT01508	SPZ150-08	8	<b>150</b>	154	3	2517	60	-	100	121	27,5	45	27,5	-
ZT01608	SPZ160-08	8	<b>160</b>	164	3	2517	60	-	100	131	27,5	45	27,5	-
ZT01808	SPZ180-08	8	<b>180</b>	184	3	2517	60	-	100	151	27,5	45	27,5	-
ZT02008	SPZ200-08	8	<b>200</b>	204	3	3020	75	-	100	171	24,5	51	24,5	-
ZT02248	SPZ224-08	8	<b>224</b>	228	3	3020	75	-	100	195	24,5	51	24,5	-
ZT02508	SPZ250-08	8	<b>250</b>	254	6	3020	75	20	100	221	24,5	51	24,5	146
ZT02808	SPZ280-08	8	<b>280</b>	284	6	3020	75	20	100	251	24,5	51	24,5	146
ZT03558	SPZ355-08	8	<b>355</b>	359	5	3030	75	-	100	326	12,5	76	12,5	146
ZT04008	SPZ400-08	8	<b>400</b>	404	5	3030	75	-	100	371	12,5	76	12,5	146
ZT04508	SPZ450-08	8	<b>450</b>	454	5	3535	90	-	100	421	5,5	89	5,5	175

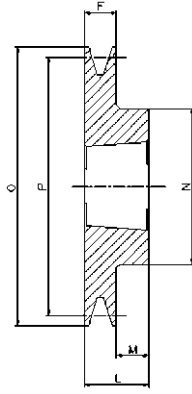

1

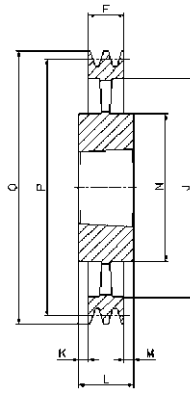

4

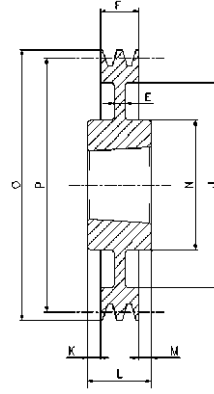

7

# SPA/1

Cod. interno Internal code Innerer Code Code interne Código interno	Tipo Type Typ Type Tipo	Gole Grooves Rillen Gorges Canales	P	O	Forma Form Forme Forme Forma	Bussola Bush Buchse Moyeu Casquillo	Ø MAX	E	F	J	K	L	M	N
AT00631	SPA 63-01	1	<b>63</b>	68,5	1	1008	25	-	20	-	-	22	2	56
AT00671	SPA 67-01	1	<b>67</b>	72,5	1	1108	28	-	20	-	-	22	2	56
AT00711	SPA 71-01	1	<b>71</b>	76,5	1	1108	28	-	20	-	-	22	2	60
AT00751	SPA 75-01	1	<b>75</b>	80,5	1	1108	28	-	20	-	-	22	2	56
AT00801	SPA 80-01	1	<b>80</b>	85,5	1	1210	32	-	20	-	-	25	5	75
AT00851	SPA 85-01	1	<b>85</b>	90,5	1	1210	32	-	20	-	-	25	5	80
AT00901	SPA 90-01	1	<b>90</b>	95,5	1	1210	32	-	20	-	-	25	5	80
AT00951	SPA 95-01	1	<b>95</b>	100,5	1	1210	32	-	20	-	-	25	5	85
AT01001	SPA100-01	1	<b>100</b>	105,5	1	1610	42	-	20	-	-	25	5	85
AT01061	SPA106-01	1	<b>106</b>	111,5	1	1610	42	-	20	-	-	25	5	92
AT01121	SPA112-01	1	<b>112</b>	117,5	1	1610	42	-	20	-	-	25	5	92
AT01181	SPA118-01	1	<b>118</b>	123,5	1	1610	42	-	20	-	-	25	5	92
AT01251	SPA125-01	1	<b>125</b>	130,5	1	1610	42	-	20	-	-	25	5	92
AT01321	SPA132-01	1	<b>132</b>	137,5	1	1610	42	-	20	-	-	25	5	92
AT01401	SPA140-01	1	<b>140</b>	145,5	1	1610	42	-	20	-	-	25	5	92
AT01501	SPA150-01	1	<b>150</b>	155,5	1	1610	42	-	20	-	-	25	5	92
AT01601	SPA160-01	1	<b>160</b>	165,5	1	1610	42	-	20	-	-	25	5	92
AT01701	SPA170-01	1	<b>170</b>	175,5	1	1610	42	-	20	-	-	25	5	92
AT01801	SPA180-01	1	<b>180</b>	185,5	7	1610	42	6	20	145	-	25	5	92
AT01901	SPA190-01	1	<b>190</b>	195,5	7	1610	42	6	20	156	-	25	5	92
AT02001	SPA200-01	1	<b>200</b>	205,5	7	2012	50	6	20	165	-	32	12	108
AT02121	SPA212-01	1	<b>212</b>	217,5	7	2012	50	10	20	177	-	32	12	110
AT02241	SPA224-01	1	<b>224</b>	229,5	7	2012	50	10	20	189	-	32	12	112
AT02361	SPA236-01	1	<b>236</b>	241,5	7	2012	50	10	20	202	-	32	12	112
AT02501	SPA250-01	1	<b>250</b>	255,5	7	2012	50	10	20	215	6	32	6	112
AT02801	SPA280-01	1	<b>280</b>	285,5	7	2012	50	10	20	245	-	32	12	112
AT03001	SPA300-01	1	<b>300</b>	305,5	7	2012	50	12	20	265	-	32	12	112
AT03151	SPA315-01	1	<b>315</b>	320,5	7	2012	50	12	20	280	-	32	12	112
AT03551	SPA355-01	1	<b>355</b>	360,5	4	2012	50	-	20	320	-	32	12	112
AT04001	SPA400-01	1	<b>400</b>	405,5	4	2012	50	-	20	365	-	32	12	112
AT04501	SPA450-01	1	<b>450</b>	455,5	4	2012	50	-	20	415	-	32	12	112
AT05001	SPA500-01	1	<b>500</b>	505,5	4	2517	60	-	20	465	-	45	25	124
AT06301	SPA630-01	1	<b>630</b>	635,5	4	2517	60	-	20	595	-	45	25	124

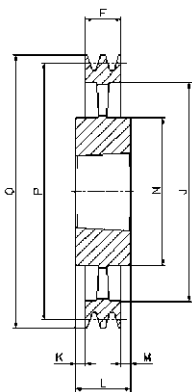

4

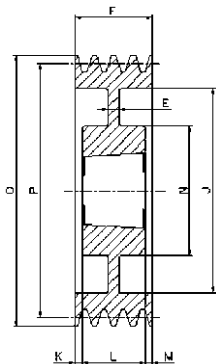

6

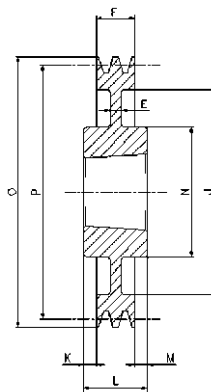

7

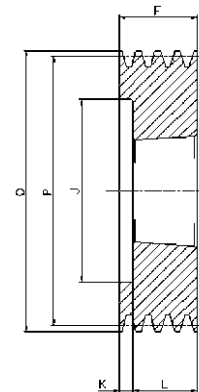

8

# SPA/2

Cod. interno Internal code Innerer Code Code interne Còdigo interno	Tipo Type Typ Type Tipo	Gole Grooves Rillen Gorges Canales	P	O	Forma Form Forme Forme Forma	Bussola Bush Buchse Moyeu Casquillo	Ø MAX	E	F	J	K	L	M	N
AT00632	SPA 63-02	2	63	68,5	8	1008	28	-	35	32,5	13,0	22	-	-
AT00672	SPA 67-02	2	67	72,5	8	1108	28	-	35	37,0	13,0	22	-	-
AT00712	SPA 71-02	2	71	76,5	8	1108	28	-	35	40,0	13,0	22	-	-
AT00752	SPA 75-02	2	75	80,5	8	1108	28	-	35	44,0	13,0	22	-	-
AT00802	SPA 80-02	2	80	85,5	8	1210	32	-	35	50,0	10,0	25	-	-
AT00852	SPA 85-02	2	85	90,5	8	1210	32	-	35	55,0	10,0	25	-	-
AT00902	SPA 90-02	2	90	95,5	8	1610	42	-	35	59,0	10,0	25	-	-
AT00952	SPA 95-02	2	95	100,5	8	1610	42	-	35	63,0	10,0	25	-	-
AT01002	SPA100-02	2	100	105,5	8	1610	42	-	35	66,0	10,0	25	-	-
AT01062	SPA106-02	2	106	111,5	8	1610	42	-	35	72,0	10,0	25	-	-
AT01122	SPA112-02	2	112	117,5	8	1610	42	-	35	78,0	10,0	25	-	-
AT01182	SPA118-02	2	118	123,5	8	1610	42	-	35	84,0	10,0	25	-	-
AT01252	SPA125-02	2	125	130,5	8	1610	42	-	35	91,0	10,0	25	-	-
AT01322	SPA132-02	2	132	137,5	8	2012	50	-	35	98,0	3,0	32	-	-
AT01402	SPA140-02	2	140	145,5	8	2012	50	-	35	106,0	3,0	32	-	-
AT01502	SPA150-02	2	150	155,5	8	2012	50	-	35	116,0	3,0	32	-	-
AT01602	SPA160-02	2	160	165,5	8	2012	50	-	35	125,0	3,0	32	-	-
AT01702	SPA170-02	2	170	175,5	8	2012	50	-	35	135,0	3,0	32	-	-
AT01802	SPA180-02	2	180	185,5	6	2012	50	10	35	146,0	1,5	32	1,5	108
AT01902	SPA190-02	2	190	195,5	6	2012	50	10	35	156,0	1,5	32	1,5	108
AT02002	SPA200-02	2	200	205,5	7	2517	60	10	35	165,0	5,0	45	5,0	123
AT02122	SPA212-02	2	212	217,5	7	2517	60	18	35	177,0	5,0	45	5,0	123
AT02242	SPA224-02	2	224	229,5	7	2517	60	18	35	189,0	-	45	10,0	124
AT02362	SPA236-02	2	236	241,5	7	2517	60	12	35	202,0	-	45	10,0	124
AT02502	SPA250-02	2	250	255,5	7	2517	60	12	35	215,0	5,0	45	5,0	124
AT02802	SPA280-02	2	280	285,5	7	2517	60	12	35	245,0	-	45	10,0	124
AT03002	SPA300-02	2	300	305,5	7	2517	60	12	35	265,0	-	45	10,0	124
AT03152	SPA315-02	2	315	320,5	7	2517	60	12	35	280,0	-	45	10,0	124
AT03552	SPA355-02	2	355	360,5	4	2517	60	-	35	320,0	-	45	10,0	124
AT04002	SPA400-02	2	400	405,5	4	2517	60	-	35	365,0	-	45	10,0	124
AT04502	SPA450-02	2	450	455,5	4	2517	60	-	35	465,0	-	45	10,0	124
AT05002	SPA500-02	2	500	505,5	4	2517	60	-	35	525,0	-	45	10,0	125
AT06302	SPA630-02	2	630	635,5	4	3020	75	-	35	595,0	8,0	51	18,0	159

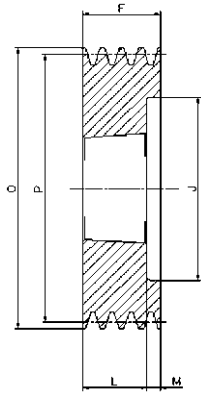

2

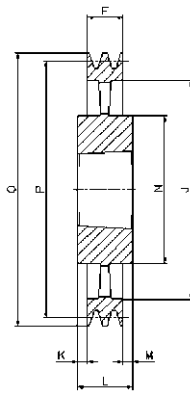

4

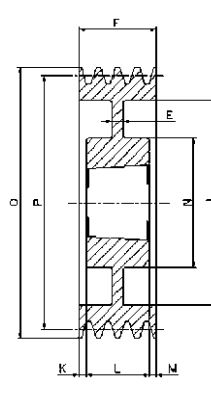

6

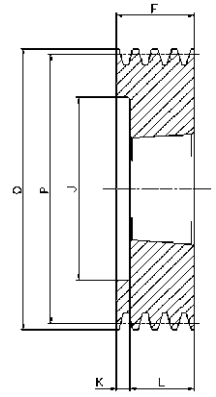

8

# SPA/3

Cod. interno Internal code Inner Code Code interne Código interno	Tipo Type Typ Type Tipo	Gole Grooves Rillen Gorges Canales	P	O	Forma Form Forme Forme Forma	Bussola Bush Buchse Moyeu Casquillo	∅ MAX	E	F	J	K	L	M	N
AT00713	SPA 71-03	3	71	76,5	8	1108	28	-	50	40	28,0	22	-	-
AT00753	SPA 75-03	3	75	80,5	8	1108	28	-	50	44	28,0	22	-	-
AT00803	SPA 80-03	3	80	85,5	8	1210	32	-	50	50	25,0	25	-	-
AT00853	SPA 85-03	3	85	90,5	8	1210	32	-	50	55	25,0	25	-	-
AT00903	SPA 90-03	3	90	95,5	8	1610	42	-	50	59	25,0	25	-	-
AT00953	SPA 95-03	3	95	100,5	8	1610	42	-	50	63	25,0	25	-	-
AT01003	SPA100-03	3	100	105,5	2	1610	42	-	50	66	-	25	25,0	-
AT01063	SPA106-03	3	106	111,5	2	1610	42	-	50	72	-	25	25,0	-
AT01123	SPA112-03	3	112	117,5	8	2012	50	-	50	78	18,0	32	-	-
AT01183	SPA118-03	3	118	123,5	2	2012	50	-	50	84	-	32	18,0	-
AT01253	SPA125-03	3	125	130,5	2	2012	50	-	50	91	-	32	18,0	-
AT01323	SPA132-03	3	132	137,5	2	2012	50	-	50	98	-	32	18,0	-
AT01403	SPA140-03	3	140	145,5	8	2517	60	-	50	106	5,0	45	-	-
AT01503	SPA150-03	3	150	155,5	8	2517	60	-	50	116	5,0	45	-	-
AT01603	SPA160-03	3	160	165,5	8	2517	60	-	50	125	5,0	45	-	-
AT01703	SPA170-03	3	170	175,5	8	2517	60	-	50	135	5,0	45	-	-
AT01803	SPA180-03	3	180	185,5	8	2517	60	-	50	146	5,0	45	-	-
AT01903	SPA190-03	3	190	195,5	8	2517	60	-	50	156	5,0	45	-	-
AT02003	SPA200-03	3	200	205,5	6	2517	60	20	50	165	2,5	45	2,5	123
AT02123	SPA212-03	3	212	217,5	6	2517	60	20	50	177	2,5	45	2,5	123
AT02243	SPA224-03	3	224	229,5	6	2517	60	20	50	189	2,5	45	2,5	124
AT02363	SPA236-03	3	236	241,5	6	2517	60	20	50	202	2,5	45	2,5	124
AT02503	SPA250-03	3	250	255,5	6	2517	60	20	50	215	2,5	45	2,5	124
AT02803	SPA280-03	3	280	285,5	6	2517	60	20	50	245	2,5	45	2,5	124
AT03003	SPA300-03	3	300	305,5	4	3020	75	-	50	265	0,5	51	0,5	146
AT03153	SPA315-03	3	315	320,5	4	3020	75	-	50	280	0,5	51	0,5	159
AT03553	SPA355-03	3	355	360,5	4	3020	75	-	50	320	0,5	51	0,5	159
AT04003	SPA400-03	3	400	405,5	4	3020	75	-	50	365	-	51	1,0	159
AT04503	SPA450-03	3	450	455,5	4	3020	75	-	50	415	-	51	1,0	159
AT05003	SPA500-03	3	500	505,5	4	3020	75	-	50	465	-	51	1,0	159
AT05603	SPA560-03	3	560	565,5	4	3020	75	-	50	525	-	51	1,0	150
AT06303	SPA630-03	3	630	635,5	4	3020	75	-	50	595	-	51	1,0	150
AT08003	SPA800-03	3	800	805,5	4	3535	90	-	50	765	19,5	89	19,5	175
AT10003	SPA1000-03	3	1000	1005,5	4	3535	90	-	50	965	19,5	89	19,5	175

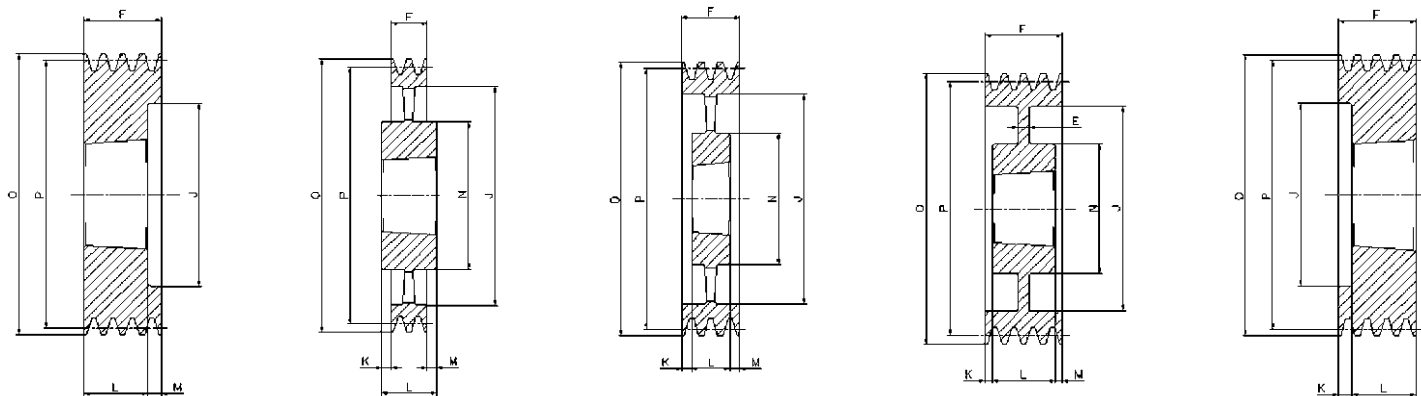

2

4

5

6

8

# SPA/4

Cod. interno Internal code Code interne Código interno	Tipo Type Typ Type Tipo	Gole Grooves Rillen Gorges Canales	P	O	Forma Form Forme Forme Forma	Bussola Bush Buchse Moyeu Casquillo	∅ MAX	E	F	J	K	L	M	N
AT00804	SPA 80-04	4	<b>80</b>	85,5	8	1215	28	-	65	49	27	38	-	-
AT00904	SPA 90-04	4	<b>90</b>	95,5	8	1615	42	-	65	59	27,0	38	-	-
AT00954	SPA 95-04	4	<b>95</b>	100,5	8	1615	42	-	65	63	27,0	38	-	-
AT01004	SPA100-04	4	<b>100</b>	105,5	2	1615	42	-	65	66	-	38	27,0	-
AT01064	SPA106-04	4	<b>106</b>	111,5	8	2012	50	-	65	72	33,0	32	-	-
AT01124	SPA112-04	4	<b>112</b>	117,5	8	2012	50	-	65	78	33,0	32	-	-
AT01184	SPA118-04	4	<b>118</b>	123,5	2	2012	50	-	65	84	-	32	33,0	-
AT01254	SPA125-04	4	<b>125</b>	130,5	2	2012	50	-	65	91	-	32	33,0	-
AT01324	SPA132-04	4	<b>132</b>	137,5	2	2517	60	-	65	98	-	45	20,0	-
AT01404	SPA140-04	4	<b>140</b>	145,5	2	2517	60	-	65	106	-	45	20,0	-
AT01504	SPA150-04	4	<b>150</b>	155,5	2	2517	60	-	65	116	-	45	20,0	-
AT01604	SPA160-04	4	<b>160</b>	165,5	2	2517	60	-	65	125	-	45	20,0	-
AT01704	SPA170-04	4	<b>170</b>	175,5	2	2517	60	-	65	135	-	45	20,0	-
AT01804	SPA180-04	4	<b>180</b>	185,5	2	2517	60	-	65	146	-	45	20,0	-
AT01904	SPA190-04	4	<b>190</b>	195,5	2	2517	60	-	65	156	-	45	20,0	-
AT02004	SPA200-04	4	<b>200</b>	205,5	2	3020	75	-	65	165	-	51	14,0	-
AT02124	SPA212-04	4	<b>212</b>	217,5	2	3020	75	-	65	177	-	51	14,0	-
AT02244	SPA224-04	4	<b>224</b>	229,5	2	3020	75	-	65	189	-	51	14,0	-
AT02364	SPA236-04	4	<b>236</b>	241,5	6	3020	75	25	65	202	-	51	14,0	-
AT02504	SPA250-04	4	<b>250</b>	255,5	6	3020	75	20	65	215	7,0	51	7,0	159
AT02804	SPA280-04	4	<b>280</b>	285,5	6	3020	75	25	65	245	7,0	51	7,0	159
AT03004	SPA300-04	4	<b>300</b>	305,5	6	3020	75	25	65	265	7,0	51	7,0	159
AT03154	SPA315-04	4	<b>315</b>	320,5	6	3020	75	25	65	280	7,0	51	7,0	159
AT03554	SPA355-04	4	<b>355</b>	360,5	5	3020	75	-	65	320	7,0	51	7,0	159
AT04004	SPA400-04	4	<b>400</b>	405,5	5	3020	75	-	65	365	7,0	51	7,0	159
AT04504	SPA450-04	4	<b>450</b>	455,5	5	3020	75	-	65	415	7,0	51	7,0	159
AT05004	SPA500-04	4	<b>500</b>	505,5	5	3020	75	-	65	465	7,0	51	7,0	159
AT05604	SPA560-04	4	<b>560</b>	565,5	4	3535	90	-	65	525	12,0	89	12,0	175
AT06304	SPA630-04	4	<b>630</b>	635,5	4	3535	90	-	65	595	12,0	89	12,0	175
AT08004	SPA800-04	4	<b>800</b>	805,5	4	3535	90	-	65	765	12,0	89	12,0	175
AT10004	SPA1000-04	4	<b>1000</b>	1005,5	4	4040	100	-	65	965	18,5	102	18,5	210

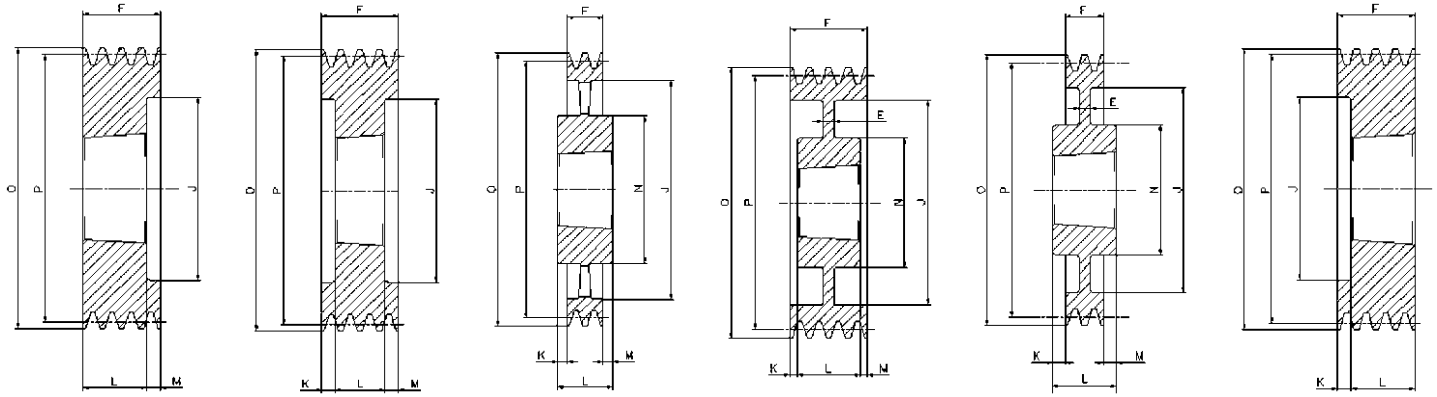

2

3

4

6

7

8

# SPA/5

Cod. interno Internal code Inner Code Code interne Código interno	Tipo Type Typ Type Tipo	Gole Grooves Rillen Gorges Canales	P	O	Forma Form Forme Forme Forma	Bussola Bush Buchse Moyeu Casquillo	Ø MAX	E	F	J	K	L	M	N
AT01005	SPA100-05	5	100	105,5	2	1615	42	-	80	66	-	38	42,0	-
AT01065	SPA106-05	5	106	111,5	8	2012	50	-	80	72	48,0	32	-	-
AT01125	SPA112-05	5	112	117,5	8	2012	50	-	80	78	48,0	32	-	-
AT01185	SPA118-05	5	118	123,5	2	2012	50	-	80	84	-	32	48,0	-
AT01255	SPA125-05	5	125	130,5	3	2012	50	-	80	91	24,0	32	24,0	-
AT01325	SPA132-05	5	132	137,5	3	2517	60	-	80	98	17,5	45	17,5	-
AT01405	SPA140-05	5	140	145,5	3	2517	60	-	80	106	17,5	45	17,5	-
AT01505	SPA150-05	5	150	155,5	3	2517	60	-	80	116	17,5	45	17,5	-
AT01605	SPA160-05	5	160	165,5	3	2517	60	-	80	125	17,5	45	17,5	-
AT01705	SPA170-05	5	170	175,5	3	2517	60	-	80	135	17,5	45	17,5	-
AT01805	SPA180-05	5	180	185,5	3	3020	75	-	80	146	-	51	29,0	-
AT01905	SPA190-05	5	190	195,5	2	3020	75	-	80	156	14,5	51	14,5	-
AT02005	SPA200-05	5	200	205,5	3	3020	75	-	80	165	14,5	51	14,5	-
AT02125	SPA212-05	5	212	217,5	2	3020	75	-	80	177	-	51	29,0	-
AT02245	SPA224-05	5	224	229,5	2	3020	75	-	80	189	-	51	29,0	-
AT02365	SPA236-05	5	236	241,5	2	3020	75	-	80	202	-	51	29,0	-
AT02505	SPA250-05	5	250	255,5	6	3020	75	20	80	215	14,5	51	14,5	159
AT02805	SPA280-05	5	280	285,5	7	3535	90	25	80	245	4,5	89	4,5	175
AT03005	SPA300-05	5	300	305,5	7	3535	90	25	80	265	4,5	89	4,5	175
AT03155	SPA315-05	5	315	320,5	7	3535	90	25	80	280	4,5	89	4,5	175
AT03555	SPA355-05	5	355	360,5	4	3535	90	-	80	320	4,5	89	4,5	175
AT04005	SPA400-05	5	400	405,5	4	3535	90	-	80	365	4,5	89	4,5	175
AT04505	SPA450-05	5	450	455,5	4	3535	90	-	80	415	4,5	89	4,5	175
AT05005	SPA500-05	5	500	505,5	4	3535	90	-	80	465	4,5	89	4,5	175
AT05605	SPA560-05	5	560	565,5	4	3535	90	-	80	525	4,5	89	4,5	175
AT06305	SPA630-05	5	630	635,5	4	3535	90	-	80	595	4,5	89	4,5	175
AT08005	SPA800-05	5	800	805,5	4	4040	100	-	80	765	11,0	102	11,0	210
AT10005	SPA1000-05	5	1000	1005,5	4	4545	110	-	80	965	17,0	114	17,0	242

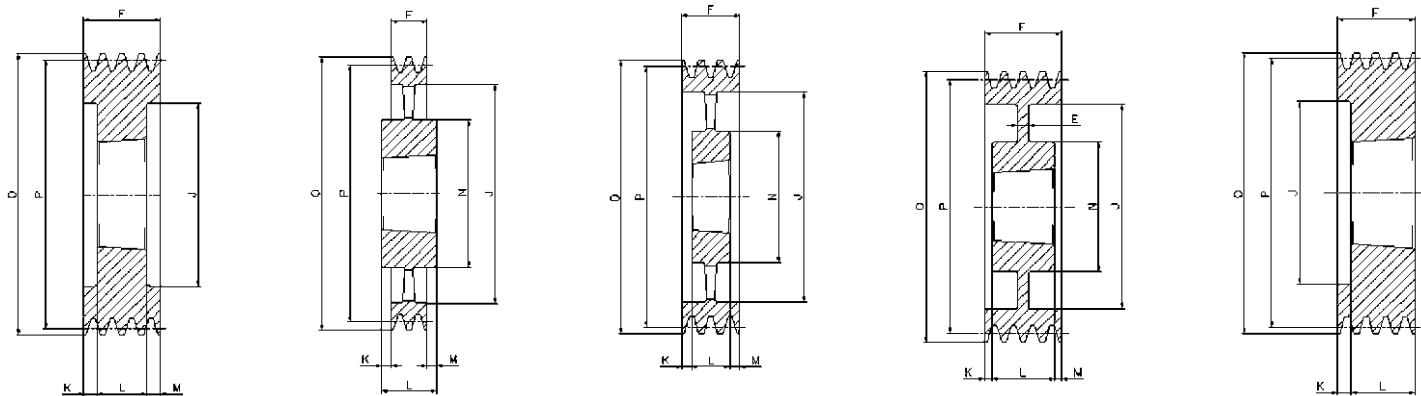

3

4

5

6

8

# SPA/6

Cod. interno Internal code Inner Code Code interne Código interno	Tipo Type Typ Type Tipo	Gole Grooves Rillen Gorges Canales	P	O	Forma Form Forme Forme Forma	Bussola Bush Buchse Moyeu Casquillo	∅ MAX	E	F	J	K	L	M	N
AT01006	SPA100-06	6	100	105,5	3	1610	42	-	95	66	30,0	25	40,0	-
AT01066	SPA106-06	6	106	111,5	8	2012	50	-	95	72	63,0	32	-	-
AT01126	SPA112-06	6	112	117,5	8	2012	50	-	95	78	63,0	32	-	-
AT01186	SPA118-06	6	118	123,5	8	2012	50	-	95	84	63,0	32	-	-
AT01256	SPA125-06	6	125	130,5	3	2012	50	-	95	91	31,5	32	31,5	-
AT01326	SPA132-06	6	132	137,5	3	2517	60	-	95	98	25,0	45	25,0	-
AT01406	SPA140-06	6	140	145,5	3	2517	60	-	95	106	25,0	45	25,0	-
AT01506	SPA150-06	6	150	155,5	3	2517	60	-	95	116	25,0	45	25,0	-
AT01606	SPA160-06	6	160	165,5	3	2517	60	-	95	125	25,0	45	25,0	-
AT01806	SPA180-06	6	180	185,5	3	3020	75	-	95	146	22,0	51	22,0	-
AT02006	SPA200-06	6	200	205,5	3	3020	75	-	95	165	22,0	51	22,0	-
AT02126	SPA212-06	6	212	217,5	3	3020	75	-	95	176	22,0	51	22,0	-
AT02246	SPA224-06	6	224	229,5	3	3020	75	-	95	189	22,0	51	22,0	-
AT02366	SPA236-06	6	236	241,5	3	3020	75	-	95	202	22,0	51	22,0	-
AT02506	SPA250-06	6	250	255,5	6	3020	75	20	95	215	22,0	51	22,0	155
AT02806	SPA280-06	6	280	285,5	6	3535	90	25	95	245	3,0	89	3,0	175
AT03006	SPA300-06	6	300	305,5	6	3535	90	25	95	265	3,0	89	3,0	175
AT03156	SPA315-06	6	315	320,5	6	3535	90	25	95	280	3,0	89	3,0	175
AT03556	SPA355-06	6	355	360,5	5	3535	90	-	95	320	3,0	89	3,0	175
AT04006	SPA400-06	6	400	405,5	5	3535	90	-	95	365	3,0	89	3,0	175
AT04506	SPA450-06	6	450	455,5	5	3535	90	-	95	415	3,0	89	3,0	175
AT05006	SPA500-06	6	500	505,5	5	3535	90	-	95	465	3,0	89	3,0	175
AT05606	SPA560-06	6	560	565,5	5	3535	90	-	95	525	3,0	89	3,0	175
AT06306	SPA630-06	6	630	635,5	4	4040	100	-	95	595	3,5	102	3,5	210
AT08006	SPA800-06	6	800	805,5	4	4040	100	-	95	765	3,5	102	3,5	210
AT10006	SPA1000-06	6	1000	1005,5	4	4545	110	-	95	965	9,5	114	9,5	242

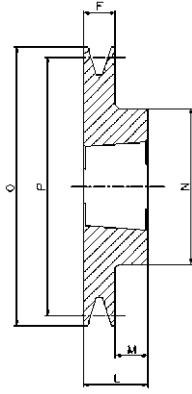

1

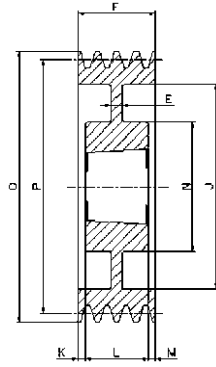

6

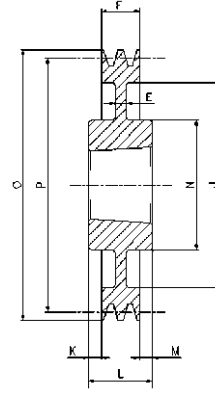

7

# SPB/1

Cod. interno Internal code Innerer Code Code interne Código interno	Tipo Type Typ Type Tipo	Gole Grooves Rillen Gorges Canales	P	O	Forma Form Forme Forme Forma	Bussola Bush Buchse Moyeu Casquillo	Ø MAX	E	F	J	K	L	M	N
BT01001	SPB100-01	1	100	107	1	1610	42	-	25	-	-	25	-	-
BT01061	SPB106-1	1	106	113	1	1610	42	-	25	-	-	25	-	-
BT01121	SPB112-01	1	112	119	1	1610	42	-	25	-	-	25	-	-
BT01181	SPB118-01	1	118	125	1	1610	42	-	25	-	-	25	-	-
BT01251	SPB125-01	1	125	132	1	1610	42	-	25	-	-	25	-	-
BT01321	SPB132-01	1	132	139	1	1610	42	-	25	-	-	25	-	-
BT01401	SPB140-01	1	140	147	1	1610	42	-	25	-	-	25	-	-
BT01501	SPB150-01	1	150	157	1	1610	42	-	25	-	-	25	-	-
BT01601	SPB160-01	1	160	167	1	1610	42	-	25	-	-	25	-	-
BT01701	SPB170-01	1	170	177	1	1610	42	-	25	-	-	25	-	-
BT01801	SPB180-01	1	180	187	6	1610	42	15	25	132	-	25	-	90
BT01901	SPB190-01	1	190	197	7	2012	50	15	25	147	3,5	32	3,5	104
BT02001	SPB200-01	1	200	207	7	2012	50	15	25	157	3,5	32	3,5	104
BT02121	SPB212-01	1	212	219	7	2012	50	15	25	169	3,5	32	3,5	104
BT02241	SPB224-01	1	224	231	7	2012	50	15	25	181	3,5	32	3,5	104
BT02361	SPB236-01	1	236	243	7	2012	50	15	25	193	3,5	32	3,5	104
BT02501	SPB250-01	1	250	257	7	2012	50	20	25	207	3,5	32	3,5	104
BT02801	SPB280-01	1	280	287	7	2012	50	20	25	237	3,5	32	3,5	104
BT03001	SPB300-01	1	300	307	7	2012	50	20	25	258	3,5	32	3,5	104
BT03151	SPB315-01	1	315	322	7	2012	50	20	25	272	3,5	32	3,5	104



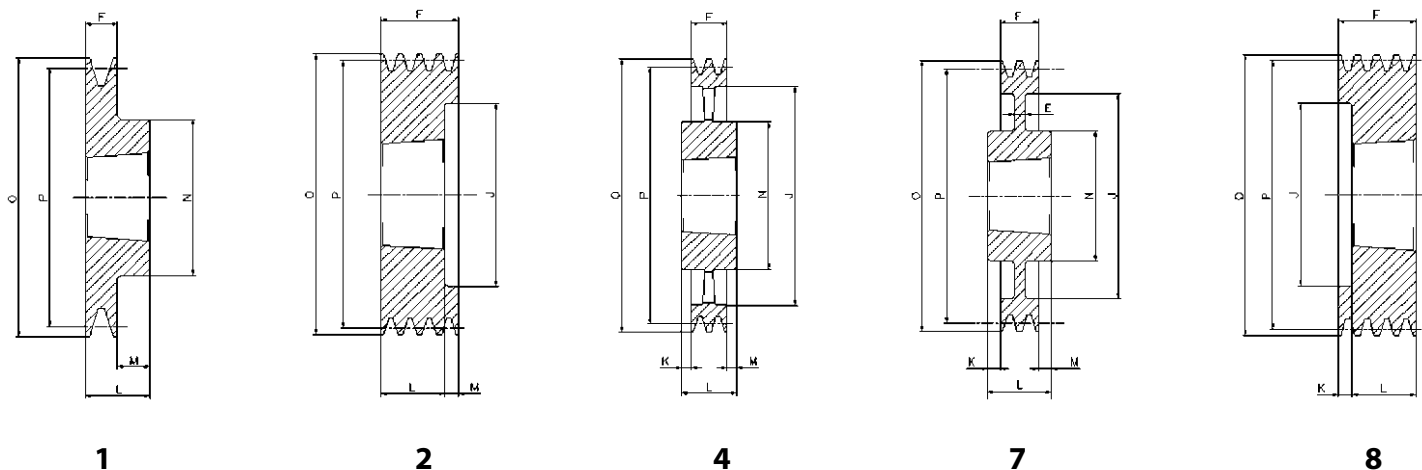

# SPB/2

Cod. interno Internal code Innerer Code Code interne Código interno	Tipo Type Typ Type Tipo	Gole Grooves Rillen Gorges Canales	P	O	Forma Form Forme Forme Forma	Bussola Bush Buchse Moyeu Casquillo	Ø MAX	E	F	J	K	L	M	N
BT01002	SPB100-02	2	<b>100</b>	107	8	1610	42	-	44	62	19,0	25	-	-
BT01062	SPB106-02	2	<b>106</b>	113	8	1610	42	-	44	67	19,0	25	-	-
BT01122	SPB112-02	2	<b>112</b>	119	8	1610	42	-	44	72	19,0	25	-	-
BT01182	SPB118-02	2	<b>118</b>	125	2	1610	42	-	44	78	-	25	19,0	-
BT01252	SPB125-02	2	<b>125</b>	132	2	2012	50	-	44	82	-	32	12,0	-
BT01322	SPB132-02	2	<b>132</b>	139	2	2012	50	-	44	89	-	32	12,0	-
BT01402	SPB140-02	2	<b>140</b>	147	2	2012	50	-	44	97	-	32	12,0	-
BT01502	SPB150-02	2	<b>150</b>	157	2	2012	50	-	44	107	-	32	12,0	-
BT01602	SPB160-02	2	<b>160</b>	167	2	2012	50	-	44	117	-	32	12,0	-
BT01702	SPB170-02	2	<b>170</b>	177	2	2012	50	-	44	127	-	32	12,0	-
BT01802	SPB180-02	2	<b>180</b>	187	1	2517	60	-	44	-	-	45	1,0	120
BT01902	SPB190-02	2	<b>190</b>	197	1	2517	60	-	44	-	-	45	1,0	120
BT02002	SPB200-02	2	<b>200</b>	207	1	2517	60	-	44	-	-	45	1,0	117
BT02122	SPB212-02	2	<b>212</b>	219	7	2517	60	20	44	169	-	45	1,0	117
BT02242	SPB224-02	2	<b>224</b>	231	7	2517	60	15	44	181	-	45	1,0	117
BT02362	SPB236-02	2	<b>236</b>	243	7	2517	60	15	44	193	-	45	1,0	117
BT02502	SPB250-02	2	<b>250</b>	257	7	2517	60	20	44	207	-	45	1,0	125
BT02802	SPB280-02	2	<b>280</b>	287	7	2517	60	20	44	237	-	45	1,0	125
BT03002	SPB300-02	2	<b>300</b>	307	7	2517	60	20	44	257	-	45	1,0	125
BT03152	SPB315-02	2	<b>315</b>	322	7	2517	60	20	44	272	-	45	1,0	125
BT03352	SPB335-02	2	<b>335</b>	342	7	2517	60	20	44	292	-	45	1,0	125
BT03552	SPB355-02	2	<b>355</b>	362	7	3020	75	15	44	312	3,5	51	3,5	144
BT04002	SPB400-02	2	<b>400</b>	407	4	3020	75	-	44	357	3,5	51	3,5	150
BT04502	SPB450-02	2	<b>450</b>	457	4	3020	75	-	44	407	3,5	51	3,5	150
BT05002	SPB500-02	2	<b>500</b>	507	4	3020	75	-	44	457	3,5	51	3,5	150
BT05602	SPB560-02	2	<b>560</b>	567	4	3030	75	-	44	517	4,0	76	28,0	150
BT06302	SPB630-02	2	<b>630</b>	637	4	3030	75	-	44	587	16,0	76	16,0	150

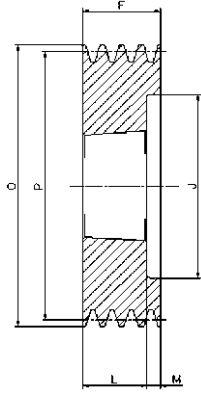

2

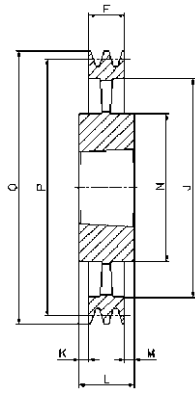

4

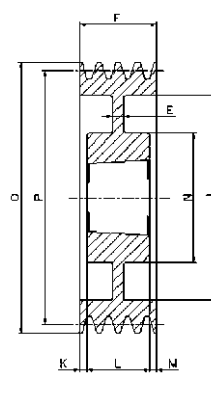

6

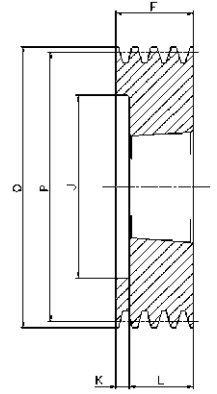

8

# SPB/3

Cod. interno Internal code Innerer Code Code interne Código interno	Tipo Type Typ Type Tipo	Gole Grooves Rillen Gorges Canales	P	O	Forma Form Forme Forme Forma	Bussola Bush Buchse Moyeu Casquillo	Ø MAX	E	F	J	K	L	M	N
BT01003	SPB100-03	3	100	107	8	1610	42	-	63	62	38,0	25	-	-
BT01063	SPB106-03	3	106	113	8	1610	42	-	63	67	38,0	25	-	-
BT01123	SPB112-03	3	112	119	8	1610	42	-	63	72	38,0	25	-	-
BT01183	SPB118-03	3	118	125	2	1610	42	-	63	78	-	25	38,0	-
BT01253	SPB125-03	3	125	132	2	2012	50	-	63	82	-	32	31,0	-
BT01323	SPB132-03	3	132	139	2	2012	50	-	63	89	-	32	31,0	-
BT01403	SPB140-03	3	140	147	2	2012	50	-	63	97	-	32	31,0	-
BT01503	SPB150-03	3	150	157	2	2517	60	-	63	107	-	45	18,0	-
BT01603	SPB160-03	3	160	167	2	2517	60	-	63	117	-	45	18,0	-
BT01703	SPB170-03	3	170	177	2	2517	60	-	63	127	-	45	18,0	-
BT01803	SPB180-03	3	180	187	2	2517	60	-	63	137	-	45	18,0	-
BT01903	SPB190-03	3	190	197	2	2517	60	-	63	147	-	45	18,0	-
BT02003	SPB200-03	3	200	207	2	2517	60	-	63	157	-	45	18,0	-
BT02123	SPB212-03	3	212	219	6	2517	60	15	63	169	-	45	18,0	117
BT02243	SPB224-03	3	224	231	6	2517	60	15	63	181	-	45	18,0	117
BT02363	SPB236-03	3	236	243	6	2517	60	15	63	193	-	45	18,0	117
BT02503	SPB250-03	3	250	257	6	3020	75	20	63	207	-	51	12,0	144
BT02803	SPB280-03	3	280	287	6	3020	75	20	63	237	6,0	51	6,0	144
BT03003	SPB300-03	3	300	307	6	3020	75	20	63	257	6,0	51	6,0	144
BT03153	SPB315-03	3	315	322	6	3020	75	20	63	272	6,0	51	6,0	144
BT03353	SPB335-03	3	335	342	6	3020	75	20	63	292	6,0	51	6,0	144
BT03553	SPB355-03	3	355	362	6	3020	75	15	63	312	6,0	51	6,0	144
BT04003	SPB400-03	3	400	407	4	3535	90	-	63	357	13,0	89	13,0	175
BT04503	SPB450-03	3	450	457	4	3535	90	-	63	407	-	89	26,0	175
BT05003	SPB500-03	3	500	507	4	3535	90	-	63	457	-	89	26,0	175
BT05603	SPB560-03	3	560	567	4	3535	90	-	63	517	-	89	26,0	175
BT06303	SPB630-03	3	630	637	4	3535	90	-	63	587	-	89	26,0	175
BT07103	SPB710-03	3	710	717	4	3535	90	-	63	664	13,0	89	13,0	175
BT08003	SPB800-03	3	800	807	4	3535	90	-	63	754	13,0	89	13,0	175
BT09003	SPB900-03	3	900	907	4	3535	90	-	63	854	13,0	89	13,0	175
BT10003	SPB1000-03	3	1000	1007	4	4040	100	-	63	954	19,5	102	19,5	210
BT12503	SPB1250-03	3	1250	1257	4	4040	100	-	63	1204	19,5	102	19,5	210

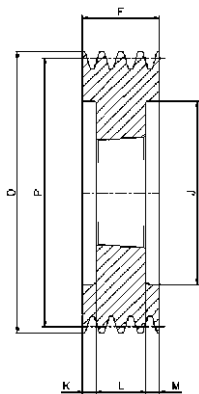

3

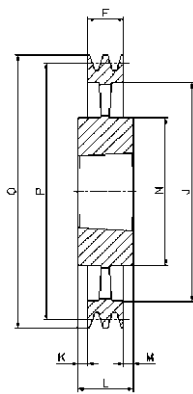

4

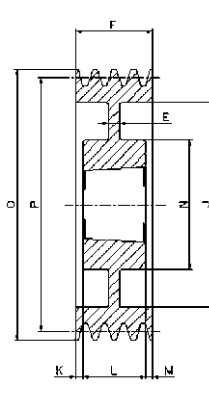

6

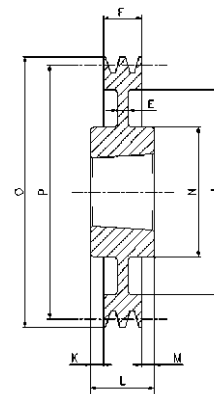

7

# SPB/4

Cod. interno Internal code Innerer Code Code interne Código interno	Tipo Type Typ Type Tipo	Gole Grooves Rillen Gorges Canales	P	O	Forma Form Forme Forme Forma	Bussola Bush Buchse Moyeu Casquillo	Ø MAX	E	F	J	K	L	M	N
BT01004	SPB100-04	4	100	117	8	1615	42	-	82	60	44,0	38	-	-
BT01124	SPB112-04	4	112	119	8	2012	42	-	82	72	50,0	32	-	-
BT01254	SPB125-04	4	125	132	3	2012	50	-	82	82	25,0	32	25,0	-
BT01324	SPB132-04	4	132	139	3	2012	50	-	82	89	25,0	32	25,0	-
BT01404	SPB140-04	4	140	147	3	2517	60	-	82	100	18,5	45	18,5	-
BT01504	SPB150-04	4	150	157	3	2517	60	-	82	107	18,5	45	18,5	-
BT01604	SPB160-04	4	160	167	3	2517	60	-	82	117	18,5	45	18,5	-
BT01704	SPB170-04	4	170	177	3	2517	60	-	82	127	18,5	45	18,5	-
BT01804	SPB180-04	4	180	187	3	2517	60	-	82	137	18,5	45	18,5	-
BT01904	SPB190-04	4	190	197	3	2517	60	-	82	147	18,5	45	18,5	-
BT02004	SPB200-04	4	200	207	3	3020	75	-	82	157	15,5	51	15,5	-
BT02124	SPB212-04	4	212	219	3	3020	75	-	82	169	15,5	51	15,5	-
BT02244	SPB224-04	4	224	231	3	3020	75	-	82	181	15,5	51	15,5	-
BT02364	SPB236-04	4	236	243	3	3020	75	-	82	193	15,5	51	15,5	-
BT02504	SPB250-04	4	250	257	6	3020	75	25	82	207	15,5	51	15,5	144
BT02804	SPB280-04	4	280	287	6	3020	75	25	82	237	15,5	51	15,5	144
BT03004	SPB300-04	4	300	307	7	3535	90	25	82	257	-	89	7,0	175
BT03154	SPB315-04	4	315	322	7	3535	90	25	82	272	3,5	89	3,5	175
BT03354	SPB335-04	4	335	342	7	3535	90	25	82	292	3,5	89	3,5	175
BT03554	SPB355-04	4	355	362	7	3535	90	25	82	312	3,5	89	3,5	175
BT04004	SPB400-04	4	400	407	4	3535	90	-	82	357	3,5	89	3,5	175
BT04504	SPB450-04	4	450	457	4	3535	90	-	82	407	-	89	7,0	175
BT05004	SPB500-04	4	500	507	4	3535	90	-	82	457	-	89	7,0	175
BT05604	SPB560-04	4	560	567	4	3535	90	-	82	517	-	89	7,0	175
BT06304	SPB630-04	4	630	637	4	3535	90	-	82	587	-	89	7,0	175
BT07104	SPB710-04	4	710	717	4	3535	90	-	82	664	3,5	89	3,5	175
BT08004	SPB800-04	4	800	807	4	4040	100	-	82	754	10,0	102	10,0	210
BT09004	SPB900-04	4	900	907	4	4040	100	-	82	854	10,0	102	10,0	210
BT10004	SPB1000-04	4	1000	1007	4	4040	100	-	82	954	10,0	102	16,0	210
BT12504	SPB1250-04	4	1250	1257	4	4545	110	-	82	1204	16,0	114	16,0	210

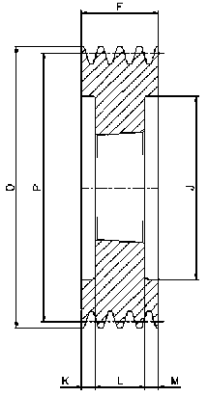

3

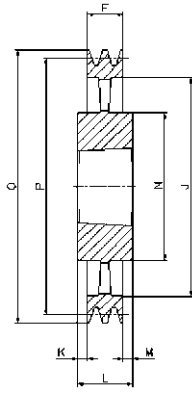

4

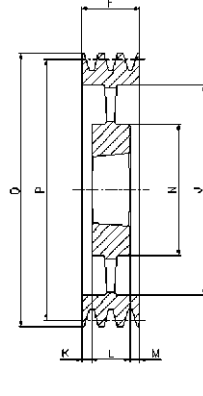

5

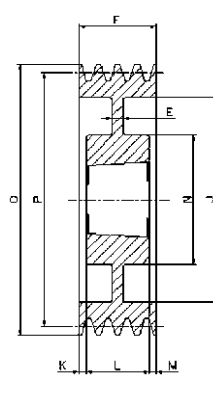

6

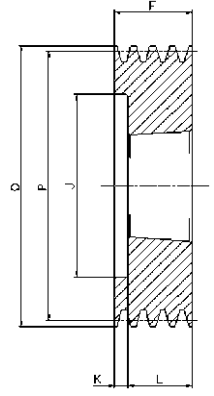

8

# SPB/5

Cod. interno Internal code Code interne Código interno	Tipo Type Typ Type Tipo	Gole Grooves Rillen Gorges Canales	P	O	Forma Form Forme Forme Forma	Bussola Bush Buchse Moyeu Casquillo	∅ MAX	E	F	J	K	L	M	N
BT01255	SPB125-05	5	125	132	8	2012	50	-	101	87	69,0	32	-	-
BT01325	SPB132-05	5	132	139	8	2517	60	-	101	94	56,0	45	-	-
BT01405	SPB140-05	5	140	147	3	2517	60	-	101	97	28,0	45	28,0	-
BT01505	SPB150-05	5	150	157	3	2517	60	-	101	107	28,0	45	28,0	-
BT01605	SPB160-05	5	160	167	3	2517	60	-	101	117	28,0	45	28,0	-
BT01705	SPB170-05	5	170	177	3	3020	75	-	101	127	25,0	51	25,0	-
BT01805	SPB180-05	5	180	187	3	3020	75	-	101	137	25,0	51	25,0	-
BT01905	SPB190-05	5	190	197	3	3020	75	-	101	147	25,0	51	25,0	-
BT02005	SPB200-05	5	200	207	3	3020	75	-	101	157	25,0	51	25,0	-
BT02125	SPB212-05	5	212	219	3	3020	75	-	101	169	25,0	51	25,0	-
BT02245	SPB224-05	5	224	231	3	3020	75	-	101	181	25,0	51	25,0	-
BT02365	SPB236-05	5	236	243	3	3535	90	-	101	193	6,0	89	6,0	-
BT02505	SPB250-05	5	250	257	3	3535	90	-	101	207	6,0	89	6,0	-
BT02805	SPB280-05	5	280	287	6	3535	90	25	101	237	6,0	89	6,0	175
BT03005	SPB300-05	5	300	307	6	3535	90	25	101	257	6,0	89	6,0	175
BT03155	SPB315-05	5	315	322	6	3535	90	25	101	272	6,0	89	6,0	175
BT03355	SPB335-05	5	335	342	6	3535	90	25	101	292	6,0	89	6,0	175
BT03555	SPB355-05	5	355	362	6	3535	90	17	101	312	6,0	89	6,0	175
BT04005	SPB400-05	5	400	407	5	3535	90	-	101	357	6,0	89	6,0	175
BT04505	SPB450-05	5	450	457	5	3535	90	-	101	407	-	89	12,0	175
BT05005	SPB500-05	5	500	507	5	3535	90	-	101	457	-	89	12,0	175
BT05605	SPB560-05	5	560	567	4	4040	100	-	101	517	-	102	1,0	210
BT06305	SPB630-05	5	630	637	4	4040	100	-	101	587	-	102	1,0	210
BT07105	SPB710-05	5	710	717	4	4040	100	-	101	664	-	102	1,0	210
BT08005	SPB800-05	5	800	807	4	4040	100	-	101	754	-	102	1,0	210
BT09005	SPB900-05	5	900	907	4	4040	100	-	101	854	-	102	1,0	210
BT10005	SPB1000-05	5	1000	1007	4	4545	110	-	101	954	6,5	114	6,5	242
BT12505	SPB1250-05	5	1250	1257	4	4545	110	-	101	1204	6,5	114	6,5	242

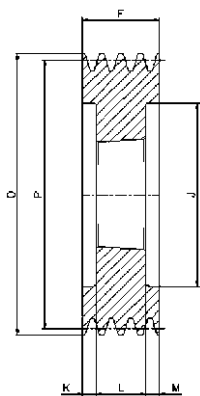

3

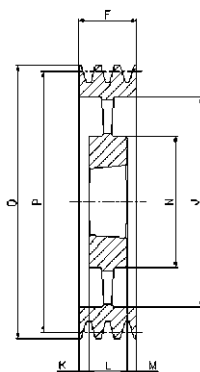

5

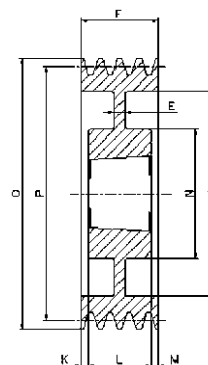

6

# SPB/6

Cod. interno Internal code Inner Code Code interne Código interno	Tipo Type Typ Type Tipo	Gole Grooves Rillen Gorges Canales	P	O	Forma Form Forme Forme Forma	Bussola Buchse Moyeu Casquillo	∅ MAX	E	F	J	K	L	M	N
BT01406	SPB140-06	6	140	147	3	2517	60	-	120	100	37,5	45	37,5	-
BT01506	SPB150-06	6	150	157	3	2517	60	-	120	107	37,5	45	37,5	-
BT01606	SPB160-06	6	160	167	3	3020	75	-	120	117	34,5	51	34,5	-
BT01706	SPB170-06	6	170	177	3	3020	75	-	120	127	34,5	51	34,5	-
BT01806	SPB180-06	6	180	187	3	3020	75	-	120	137	34,5	51	34,5	-
BT01906	SPB190-06	6	190	197	3	3020	75	-	120	147	34,5	51	34,5	-
BT02006	SPB200-06	6	200	207	3	3020	75	-	120	157	34,5	51	34,5	-
BT02126	SPB212-06	6	212	219	3	3535	90	-	120	169	15,5	89	15,5	-
BT02246	SPB224-06	6	224	231	3	3535	90	-	120	181	15,5	89	15,5	-
BT02366	SPB236-06	6	236	243	3	3535	90	-	120	193	15,5	89	15,5	-
BT02506	SPB250-06	6	250	257	3	3535	90	-	120	207	15,5	89	15,5	-
BT02806	SPB280-06	6	280	287	6	3535	90	25	120	237	15,5	89	15,5	175
BT03006	SPB300-06	6	300	307	6	3535	90	25	120	257	15,5	89	15,5	175
BT03156	SPB315-06	6	315	322	6	3535	90	25	120	272	15,5	89	15,5	175
BT03356	SPB335-06	6	335	342	6	3535	90	25	120	292	15,5	89	15,5	175
BT03556	SPB355-06	6	355	362	6	3535	90	25	120	312	15,5	89	15,5	175
BT04006	SPB400-06	6	400	407	5	3535	90	-	120	357	15,5	89	15,5	175
BT04506	SPB450-06	6	450	457	5	4040	100	-	120	407	-	102	18,0	210
BT05006	SPB500-06	6	500	507	5	4040	100	-	120	457	-	102	18,0	210
BT05606	SPB560-06	6	560	567	5	4040	100	-	120	517	-	102	18,0	210
BT06306	SPB630-06	6	630	637	5	4040	100	-	120	587	-	102	18,0	210
BT07106	SPB710-06	6	710	717	5	4040	100	-	120	664	9,0	102	9,0	210
BT08006	SPB800-06	6	800	807	5	4545	110	-	120	754	3,0	114	3,0	242
BT09006	SPB900-06	6	900	907	5	4545	110	-	120	854	3,0	114	3,0	242
BT10006	SPB1000-06	6	1000	1007	5	4545	110	-	120	954	3,0	114	3,0	242
BT12506	SPB1250-06	6	1250	1257	5	4545	110	-	120	1204	3,0	114	3,0	242

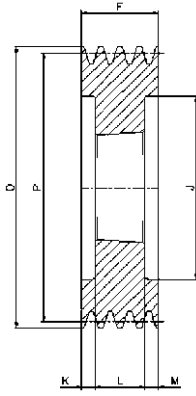

3

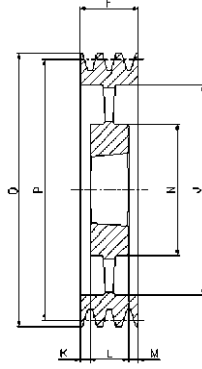

5

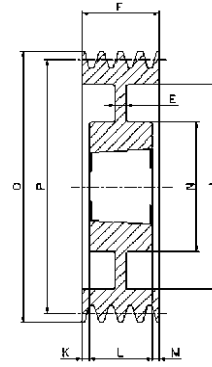

6

# SPB/8

Cod. interno Internal code Innerer Code Code interne Código interno	Tipo Type Typ Type Tipo	Gole Grooves Rillen Gorges Canales	P	O	Forma Form Forme Forme Forma	Bussola Bush Buchse Moyeu Casquillo	Ø MAX	E	F	J	K	L	M	N
BT01408	SPB140-08	8	140	147	3	2517	60	-	158	97	56,5	45	56,5	-
BT01608	SPB160-08	8	160	167	3	3020	75	-	158	117	53,5	51	53,5	-
BT01708	SPB170-08	8	170	177	3	3030	75	-	158	127	41,0	76	41,0	-
BT01808	SPB180-08	8	180	187	3	3030	75	-	158	137	41,0	76	41,0	-
BT01908	SPB190-08	8	190	197	3	3030	75	-	158	147	41,0	76	41,0	-
BT02008	SPB200-08	8	200	207	3	3535	90	-	158	157	34,5	89	34,5	-
BT02128	SPB212-08	8	212	219	3	3535	90	-	158	169	34,5	89	34,5	-
BT02248	SPB224-08	8	224	231	3	3535	90	-	158	181	34,5	89	34,5	-
BT02368	SPB236-08	8	236	243	3	3535	90	-	158	193	34,5	89	34,5	-
BT02508	SPB250-08	8	250	257	3	3535	90	-	158	207	34,5	89	34,5	-
BT02808	SPB280-08	8	280	287	6	3535	90	25	158	237	34,5	89	34,5	175
BT03008	SPB300-08	8	300	307	6	3535	90	25	158	257	34,5	89	34,5	175
BT03158	SPB315-08	8	315	322	6	3535	90	25	158	272	34,5	89	34,5	175
BT03358	SPB335-08	8	335	342	6	3535	90	25	158	292	34,5	89	34,5	175
BT03558	SPB355-08	8	355	362	6	3535	90	25	158	312	34,5	89	34,5	175
BT04008	SPB400-08	8	400	407	6	4040	100	30	158	357	28,0	102	28,0	210
BT04508	SPB450-08	8	450	457	5	4040	100	-	158	407	28,0	102	28,0	210
BT05008	SPB500-08	8	500	507	5	4040	100	-	158	457	28,0	102	28,0	210
BT05608	SPB560-08	8	560	567	5	4545	110	-	158	517	22,0	114	22,0	242
BT06308	SPB630-08	8	630	637	5	4545	110	-	158	587	22,0	114	22,0	242
BT07108	SPB710-08	8	710	717	5	4545	110	-	158	664	22,0	114	22,0	242
BT08008	SPB800-08	8	800	807	5	4545	110	-	158	754	22,0	114	22,0	242
BT09008	SPB900-08	8	900	907	5	4545	110	-	158	854	22,0	114	22,0	242
BT10008	SPB1000-08	8	1000	1007	5	5050	125	-	158	954	15,5	127	15,5	267
BT12508	SPB1250-08	8	1250	1257	5	5050	125	-	158	1204	15,5	127	15,5	267

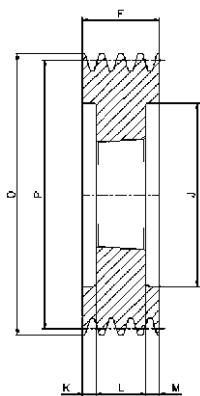

3

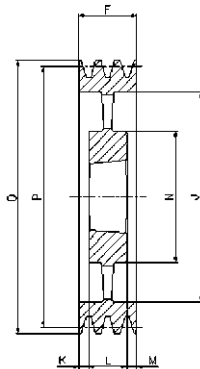

5

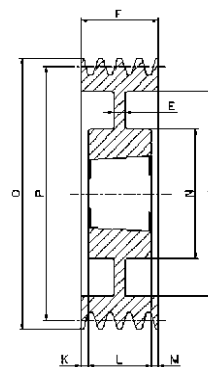

6

# SPB/10

Cod. interno Internal code Innerer Code Code interne Código interno	Tipo Type Typ Type Tipo	Gole Grooves Rillen Gorges Canales	P	O	Forma Form Forme Forme Forma	Bussola Bush Buchse Moyeu Casquillo	∅ MAX	E	F	J	K	L	M	N
BT0224X	SPB224-10	10	<b>224</b>	231	3	3535	90	-	196	181	53,5	89	53,5	-
BT0236X	SPB236-10	10	<b>236</b>	243	3	3535	90	-	196	193	53,5	89	53,5	-
BT0250X	SPB250-10	10	<b>250</b>	257	3	3535	90	-	196	207	53,5	89	53,5	-
BT0280X	SPB280-10	10	<b>280</b>	287	6	3535	90	30	196	237	53,5	89	53,5	175
BT0315X	SPB315-10	10	<b>315</b>	322	6	3535	90	30	196	272	53,5	89	53,5	175
BT0335X	SPB335-10	10	<b>335</b>	342	6	4040	100	30	196	292	47,0	102	47,0	210
BT0355X	SPB355-10	10	<b>355</b>	362	6	4040	100	30	196	312	47,0	102	47,0	210
BT0400X	SPB400-10	10	<b>400</b>	407	6	4040	100	30	196	357	47,0	102	47,0	210
BT0450X	SPB450-10	10	<b>450</b>	457	5	4545	110	-	196	407	41,0	114	41,0	242
BT0500X	SPB500-10	10	<b>500</b>	507	5	4545	110	-	196	457	41,0	114	41,0	242
BT0560X	SPB560-10	10	<b>560</b>	567	5	4545	110	-	196	517	41,0	114	41,0	242
BT0630X	SPB630-10	10	<b>630</b>	637	5	4545	110	-	196	587	41,0	114	41,0	242
BT0710X	SPB710-10	10	<b>710</b>	717	5	4545	110	-	196	664	41,0	114	41,0	242
BT0800X	SPB800-10	10	<b>800</b>	807	5	4545	110	-	196	754	41,0	114	41,0	242
BT0900X	SPB900-10	10	<b>900</b>	907	5	5050	125	-	196	854	34,5	127	34,5	267
BT1000X	SPB1000-10	10	<b>1000</b>	1007	5	5050	125	-	196	954	34,5	127	34,5	267

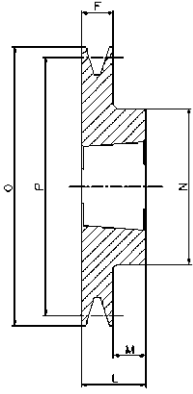

1

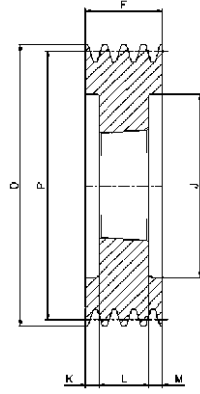

3

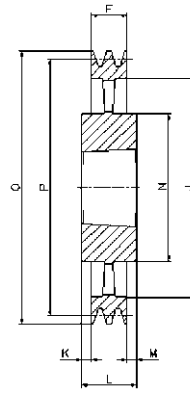

4

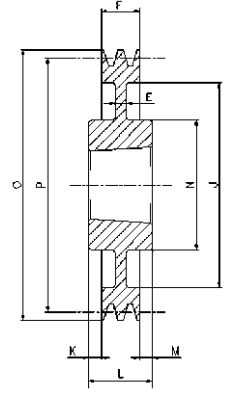

7

# SPC/3

Cod. interno Internal code Innerer Code Code interne Código interno	Tipo Type Typ Type Tipo	Gole Grooves Rillen Gorges Canales	P	O	Forma Form Forme Forme Forma	Bussola Bush Buchse Moyeu Casquillo	∅ MAX	E	F	J	K	L	M	N
CT02003	SPC200-03	3	<b>200</b>	209,6	3	2517	60	-	85	144	20,0	45	20,0	-
CT02123	SPC212-03	3	<b>212</b>	221,6	3	3020	75	-	85	156	17,0	51	17,0	-
CT02243	SPC224-03	3	<b>224</b>	233,6	3	3020	75	-	85	168	17,0	51	17,0	-
CT02363	SPC236-03	3	<b>236</b>	245,6	3	3020	75	-	85	180	17,0	51	17,0	-
CT02503	SPC250-03	3	<b>250</b>	259,6	3	3020	75	-	85	194	17,0	51	17,0	-
CT02653	SPC265-03	3	<b>265</b>	274,6	1	3535	90	-	85	209	-	89	4,0	175
CT02803	SPC280-03	3	<b>280</b>	289,6	1	3535	90	-	85	224	-	89	4,0	175
CT03003	SPC300-03	3	<b>300</b>	309,6	7	3535	90	20	85	244	2,0	89	2,0	175
CT03153	SPC315-03	3	<b>315</b>	324,6	7	3535	90	20	85	259	2,0	89	2,0	175
CT03353	SPC335-03	3	<b>335</b>	344,6	7	3535	90	20	85	279	2,0	89	2,0	175
CT03553	SPC355-03	3	<b>355</b>	364,6	7	3535	90	20	85	299	2,0	89	2,0	175
CT03753	SPC375-03	3	<b>375</b>	384,6	7	3535	90	25	85	319	2,0	89	2,0	175
CT04003	SPC400-03	3	<b>400</b>	409,6	7	3535	90	17	85	344	2,0	89	2,0	175
CT04253	SPC425-03	3	<b>425</b>	434,6	7	3535	90	17	85	369	2,0	89	2,0	175
CT04503	SPC450-03	3	<b>450</b>	459,6	4	3535	90	-	85	394	2,0	89	2,0	175
CT04753	SPC475-03	3	<b>475</b>	484,6	4	3535	90	-	85	419	2,0	89	2,0	175
CT05003	SPC500-03	3	<b>500</b>	509,6	4	3535	90	-	85	444	2,0	89	2,0	175
CT05303	SPC530-03	3	<b>530</b>	539,6	4	3535	90	-	85	474	2,0	89	2,0	175
CT05603	SPC560-03	3	<b>560</b>	569,6	4	3535	90	-	85	504	2,0	89	2,0	175
CT06303	SPC630-03	3	<b>630</b>	639,6	4	4040	100	-	85	574	8,5	102	8,5	210
CT07103	SPC710-03	3	<b>710</b>	719,6	4	4545	110	-	85	652	14,5	114	14,5	242
CT08003	SPC800-03	3	<b>800</b>	809,6	4	4545	110	-	85	737	14,5	114	14,5	242
CT10003	SPC1000-03	3	<b>1000</b>	1009,6	4	5050	125	-	85	937	21,0	127	21,0	267
CT12503	SPC1250-03	3	<b>1250</b>	1259,6	4	5050	125	-	85	1187	21,0	127	21,0	267



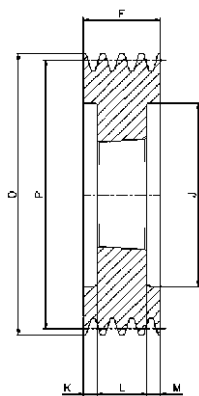

3

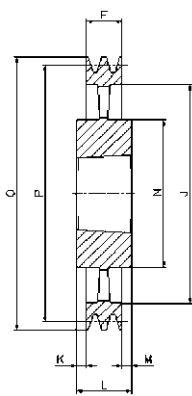

4

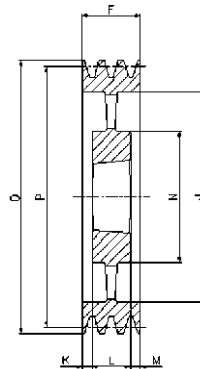

5

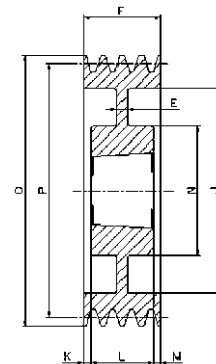

6

# SPC/4

Cod. interno Internal code Innerer Code Code interne Código interno	Tipo Type Typ Type Tipo	Gole Grooves Rillen Gorges Canales	P	O	Forma Form Forme Forme Forma	Bussola Bush Buchse Moyeu Casquillo	∅ MAX	E	F	J	K	L	M	N
CT02004	SPC200-04	4	<b>200</b>	209,6	3	3020	75	-	111	144	30,0	51	30,0	-
CT02124	SPC212-04	4	<b>212</b>	221,6	3	3020	75	-	111	156	30,0	51	30,0	-
CT02244	SPC224-04	4	<b>224</b>	233,6	3	3535	90	-	111	168	11,0	89	11,0	-
CT02364	SPC236-04	4	<b>236</b>	245,6	3	3535	90	-	111	180	11,0	89	11,0	-
CT02504	SPC250-04	4	<b>250</b>	259,6	3	3535	90	-	111	194	11,0	89	11,0	-
CT02654	SPC265-04	4	<b>265</b>	274,6	3	3535	90	-	111	209	11,0	89	11,0	-
CT02804	SPC280-04	4	<b>280</b>	289,6	6	3535	90	18	111	224	11,0	89	11,0	175
CT03004	SPC300-04	4	<b>300</b>	309,6	6	3535	90	20	111	244	11,0	89	11,0	175
CT03154	SPC315-04	4	<b>315</b>	324,6	6	3535	90	20	111	259	11,0	89	11,0	175
CT03354	SPC335-04	4	<b>335</b>	344,6	6	3535	90	20	111	279	11,0	89	11,0	175
CT03554	SPC355-04	4	<b>355</b>	364,6	6	3535	90	20	111	299	11,0	89	11,0	175
CT03754	SPC375-04	4	<b>375</b>	384,6	6	3535	90	25	111	319	11,0	89	11,0	175
CT04004	SPC400-04	4	<b>400</b>	409,6	6	3535	90	18	111	344	11,0	89	11,0	175
CT04254	SPC425-04	4	<b>425</b>	434,6	6	3535	90	18	111	369	11,0	89	11,0	175
CT04504	SPC450-04	4	<b>450</b>	459,6	5	3535	90	-	111	394	11,0	89	11,0	175
CT04754	SPC475-04	4	<b>475</b>	484,6	5	3535	90	-	111	419	11,0	89	11,0	175
CT05004	SPC500-04	4	<b>500</b>	509,6	5	3535	90	-	111	444	11,0	89	11,0	175
CT05304	SPC530-04	4	<b>530</b>	539,6	5	4040	100	-	111	474	4,5	102	4,5	210
CT05604	SPC560-04	4	<b>560</b>	569,6	5	4040	100	-	111	504	4,5	102	4,5	210
CT06304	SPC630-04	4	<b>630</b>	639,6	4	4545	110	-	111	574	1,5	114	1,5	242
CT07104	SPC710-04	4	<b>710</b>	719,6	4	5050	125	-	111	654	8,0	127	8,0	267
CT08004	SPC800-04	4	<b>800</b>	809,6	4	5050	125	-	111	737	8,0	127	8,0	267
CT10004	SPC1000-04	4	<b>1000</b>	1009,6	4	5050	125	-	111	937	8,0	127	8,0	267
CT12504	SPC1250-04	4	<b>1250</b>	1259,6	4	5050	125	-	111	1187	8,0	127	8,0	267

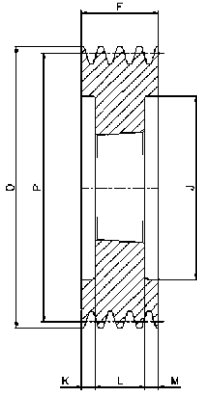

3

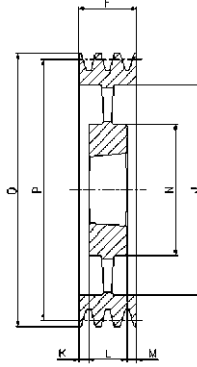

5

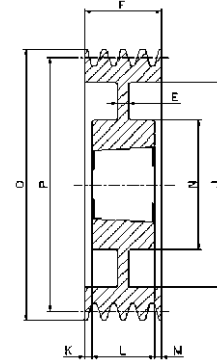

6

# SPC/5

Cod. interno Internal code Innerer Code Code interne Código interno	Tipo Type Typ Type Tipo	Gole Grooves Rillen Gorges Canales	P	O	Forma Form Forme Forme Forma	Bussola Bush Buchse Moyeu Casquillo	∅ MAX	E	F	J	K	L	M	N
CT02005	SPC200-05	5	<b>200</b>	209,6	3	3535	90	-	136	144	23,5	89	23,5	-
CT02125	SPC212-05	5	<b>212</b>	221,6	3	3535	90	-	136	156	23,5	89	23,5	-
CT02245	SPC224-05	5	<b>224</b>	233,6	3	3535	90	-	136	168	23,5	89	23,5	-
CT02365	SPC236-05	5	<b>236</b>	245,6	3	3535	90	-	136	180	23,5	89	23,5	-
CT02505	SPC250-05	5	<b>250</b>	259,6	3	3535	90	-	136	194	23,5	89	23,5	-
CT02655	SPC265-05	5	<b>265</b>	274,6	3	3535	90	-	136	209	23,5	89	23,5	-
CT02805	SPC280-05	5	<b>280</b>	289,6	3	3535	90	-	136	224	23,5	89	23,5	-
CT03005	SPC300-05	5	<b>300</b>	309,6	6	3535	90	20	136	244	23,5	89	23,5	175
CT03155	SPC315-05	5	<b>315</b>	324,6	6	3535	90	20	136	259	23,5	89	23,5	175
CT03355	SPC335-05	5	<b>335</b>	344,6	6	3535	90	20	136	279	23,5	89	23,5	175
CT03555	SPC355-05	5	<b>355</b>	364,6	6	3535	90	20	136	299	23,5	89	23,5	175
CT03755	SPC375-05	5	<b>375</b>	384,6	6	3535	90	25	136	319	23,5	89	23,5	175
CT04005	SPC400-05	5	<b>400</b>	409,6	6	3535	90	15	136	344	23,5	89	23,5	175
CT04255	SPC425-05	5	<b>425</b>	434,6	6	3535	90	20	136	369	23,5	89	23,5	175
CT04505	SPC450-05	5	<b>450</b>	459,6	5	4040	100	-	136	394	17,0	102	17,0	210
CT04755	SPC475-05	5	<b>475</b>	484,6	5	4040	100	-	136	419	17,0	102	17,0	210
CT05005	SPC500-05	5	<b>500</b>	509,6	5	4040	100	-	136	444	17,0	102	17,0	210
CT05305	SPC530-05	5	<b>530</b>	539,6	5	4545	110	-	136	474	11,0	114	11,0	240
CT05605	SPC560-05	5	<b>560</b>	569,6	5	4545	110	-	136	504	11,0	114	11,0	242
CT06305	SPC630-05	5	<b>630</b>	639,6	5	5050	125	-	136	574	4,5	127	4,5	267
CT07105	SPC710-05	5	<b>710</b>	719,6	5	5050	125	-	136	654	4,5	127	4,5	267
CT08005	SPC800-05	5	<b>800</b>	809,6	5	5050	125	-	136	737	4,5	127	4,5	267
CT10005	SPC1000-05	5	<b>1000</b>	1009,6	5	5050	125	-	136	937	4,5	127	4,5	267
CT12505	SPC1250-05	5	<b>1250</b>	1259,6	5	5050	125	-	136	1187	4,5	127	4,5	267

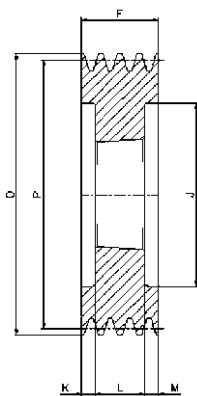

3

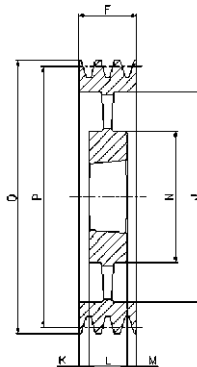

5

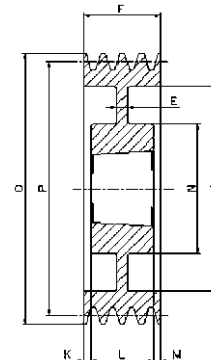

6

# SPC/6

Cod. interno Internal code Innerer Code Code interne Código interno	Tipo Type Typ Type Tipo	Gole Grooves Rillen Gorges Canales	P	O	Forma Form Forme Forme Forma	Bussola Bush Buchse Moyeu Casquillo	∅ MAX	E	F	J	K	L	M	N
CT02006	SPC200-06	6	<b>200</b>	209,6	3	3535	90	-	162	144	36,5	89	36,5	-
CT02126	SPC212-06	6	<b>212</b>	221,6	3	3535	90	-	162	156	36,5	89	36,5	-
CT02246	SPC224-06	6	<b>224</b>	233,6	3	3535	90	-	162	168	36,5	89	36,5	-
CT02366	SPC236-06	6	<b>236</b>	245,6	3	3535	90	-	162	180	36,5	89	36,5	-
CT02506	SPC250-06	6	<b>250</b>	259,6	3	3535	90	-	162	194	36,5	89	36,5	-
CT02656	SPC265-06	6	<b>265</b>	274,6	3	3535	90	-	162	209	36,5	89	36,5	-
CT02806	SPC280-06	6	<b>280</b>	289,6	6	3535	90	20	162	224	36,5	89	36,5	175
CT03006	SPC300-06	6	<b>300</b>	309,6	6	3535	90	20	162	244	36,5	89	36,5	175
CT03156	SPC315-06	6	<b>315</b>	324,6	6	3535	90	20	162	259	36,5	89	36,5	175
CT03356	SPC335-06	6	<b>335</b>	344,6	6	3535	90	20	162	279	36,5	89	36,5	175
CT03556	SPC355-06	6	<b>355</b>	364,6	6	3535	90	20	162	299	36,5	89	36,5	175
CT03756	SPC375-06	6	<b>375</b>	384,6	6	4040	100	30	162	319	30,0	102	30,0	210
CT04006	SPC400-06	6	<b>400</b>	409,6	6	4040	100	30	162	344	30,0	102	30,0	210
CT04256	SPC425-06	6	<b>425</b>	434,6	6	4040	100	30	162	369	30,0	102	24,0	210
CT04506	SPC450-06	6	<b>450</b>	459,6	6	4545	110	30	162	394	24,0	114	24,0	242
CT04756	SPC475-06	6	<b>475</b>	484,6	6	4545	110	30	162	419	24,0	114	24,0	242
CT05006	SPC500-06	6	<b>500</b>	509,6	5	4545	110	-	162	444	24,0	114	24,0	242
CT05306	SPC530-06	6	<b>530</b>	539,6	5	5050	125	-	162	474	17,5	114	17,5	265
CT05606	SPC560-06	6	<b>560</b>	569,6	5	5050	125	-	162	504	17,5	127	17,5	267
CT06306	SPC630-06	6	<b>630</b>	639,6	5	5050	125	-	162	574	17,5	127	17,5	267
CT07106	SPC710-06	6	<b>710</b>	719,6	5	5050	125	-	162	654	17,5	127	17,5	267
CT08006	SPC800-06	6	<b>800</b>	809,6	5	5050	125	-	162	737	17,5	127	17,5	267
CT10006	SPC1000-06	6	<b>1000</b>	1009,6	5	5050	125	-	162	937	17,5	127	17,5	267
CT12506	SPC1250-06	6	<b>1250</b>	1259,6	5	5050	125	-	162	1187	17,5	127	17,5	267

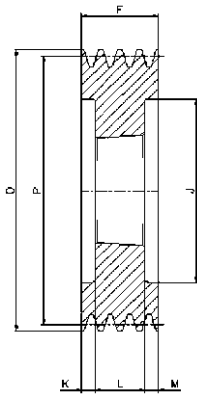

3

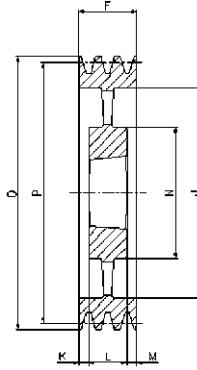

5

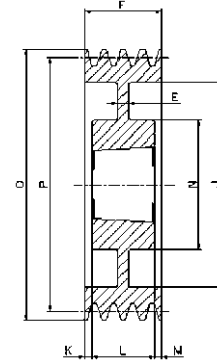

6

# SPC/8

Cod. interno Internal code Innerer Code Code interne Código interno	Tipo Type Typ Type Tipo	Gole Grooves Rillen Gorges Canales	P	O	Forma Form Forme Forme Forma	Bussola Bush Buchse Moyeu Casquillo	Ø MAX	E	F	J	K	L	M	N
CT02008	SPC200-08	8	<b>200</b>	209,6	3	3535	90	-	213	144	62,0	89	62,0	-
CT02128	SPC212-08	8	<b>212</b>	221,6	3	3535	90	-	213	156	62,0	89	62,0	-
CT02248	SPC224-08	8	<b>224</b>	233,6	3	3535	90	-	213	168	62,0	89	62,0	-
CT02368	SPC236-08	8	<b>236</b>	245,6	3	3535	90	-	213	180	62,0	89	62,0	-
CT02508	SPC250-08	8	<b>250</b>	259,6	3	3535	90	-	213	194	62,0	89	62,0	-
CT02658	SPC265-08	8	<b>265</b>	274,6	3	3535	90	-	213	209	62,0	89	62,0	-
CT02808	SPC280-08	8	<b>280</b>	289,6	3	3535	90	-	213	224	62,0	89	62,0	-
CT03008	SPC300-08	8	<b>300</b>	309,6	3	4040	100	-	213	244	55,5	102	55,5	-
CT03158	SPC315-08	8	<b>315</b>	324,6	3	4040	100	-	213	259	55,5	102	55,5	-
CT03358	SPC335-08	8	<b>335</b>	344,6	6	4040	100	50	213	279	55,5	102	55,5	210
CT03558	SPC355-08	8	<b>355</b>	364,6	6	4040	100	40	213	299	55,5	102	55,5	210
CT03758	SPC375-08	8	<b>375</b>	384,6	6	4545	110	30	213	319	49,5	114	49,5	242
CT04008	SPC400-08	8	<b>400</b>	409,6	6	4545	110	30	213	344	49,5	114	49,5	242
CT04258	SPC425-08	8	<b>425</b>	434,6	6	4545	110	30	213	369	49,5	114	49,5	240
CT04508	SPC450-08	8	<b>450</b>	459,6	6	5050	125	30	213	394	43,0	127	43,0	267
CT04758	SPC475-08	8	<b>475</b>	484,6	6	5050	125	30	213	419	43,0	127	43,0	267
CT04998	SPC500-08	8	<b>500</b>	509,6	6	5050	125	30	213	444	43,0	127	43,0	267
CT05308	SPC530-08	8	<b>530</b>	539,6	6	5050	125	30	213	474	43,0	127	43,0	267
CT05608	SPC560-08	8	<b>560</b>	569,6	5	5050	125	-	213	504	43,0	127	43,0	267
CT06308	SPC630-08	8	<b>630</b>	639,6	5	5050	125	-	213	574	43,0	127	43,0	267
CT07108	SPC710-08	8	<b>710</b>	719,6	5	5050	125	-	213	654	43,0	127	43,0	267
CT08008	SPC800-08	8	<b>800</b>	809,6	5	5050	125	-	213	737	43,0	127	43,0	267
CT09998	SPC1000-08	8	<b>1000</b>	1009,6	5	5050	125	-	213	937	43,0	127	43,0	267
CT12508	SPC1250-08	8	<b>1250</b>	1259,6	5	5050	125	-	213	1187	43,0	127	43,0	267

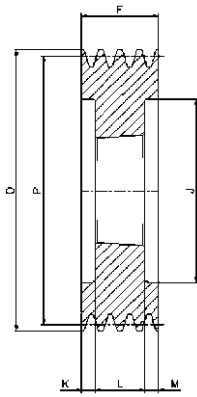

3

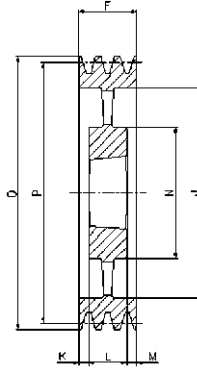

5

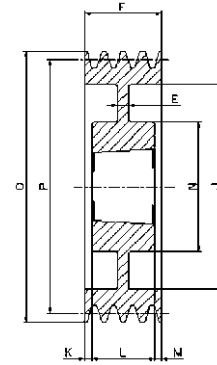

6

# SPC/10

Cod. interno Internal code Innerer Code Code interne Código interno	Tipo Type Typ Type Tipo	Gole Grooves Rillen Gorges Canales	P	O	Forma Form Forme Forme Forma	Bussola Bush Buchse Moyeu Casquillo	∅ MAX	E	F	J	K	L	M	N
CT0250X	SPC250-10	10	<b>250</b>	259,6	3	4040	100	-	264	194	81,0	102	81,0	-
CT0280X	SPC280-10	10	<b>280</b>	289,6	3	4040	100	-	264	224	81,0	102	81,0	-
CT0300X	SPC300-10	10	<b>300</b>	309,6	3	4545	110	-	264	244	75,0	114	75,0	-
CT0315X	SPC315-10	10	<b>315</b>	324,6	3	4545	110	-	264	259	75,0	114	75,0	-
CT0355X	SPC355-10	10	<b>355</b>	364,6	3	4545	110	-	264	299	75,0	114	75,0	-
CT0375X	SPC375-10	10	<b>375</b>	384,6	3	4545	110	-	264	316	75,0	114	75,0	-
CT0400X	SPC400-10	10	<b>400</b>	409,6	6	5050	125	70	264	344	68,5	127	68,5	267
CT0450X	SPC450-10	10	<b>450</b>	459,6	6	5050	125	40	264	394	68,5	127	68,5	267
CT0500X	SPC500-10	10	<b>500</b>	509,6	6	5050	125	40	264	444	68,5	127	68,5	267
CT0560X	SPC560-10	10	<b>560</b>	569,6	5	5050	125	-	264	504	68,5	127	68,5	267
CT0630X	SPC630-10	10	<b>630</b>	639,6	5	5050	125	-	264	574	68,5	127	68,5	267
CT0710X	SPC710-10	10	<b>710</b>	719,6	5	5050	125	-	264	654	68,5	127	68,5	267
CT0800X	SPC800-10	10	<b>800</b>	809,6	5	5050	125	-	264	737	68,5	127	68,5	267
CT1000X	SPC1000-10	10	<b>1000</b>	1009,6	5	5050	125	-	264	937	68,5	127	68,5	267
CT1250X	SPC1250-10	10	<b>1250</b>	1259,6	5	5050	125	-	264	1187	68,5	127	68,5	267



## **PULEGGE TRAPEZOIDALI MONOBLOCCO**

V-Belt pulleys with solid hub  
Keilriemenscheiben ungebohrt  
Poulies trapézoidales moyeu plein  
Poleas trapezoidales con cubo macizo

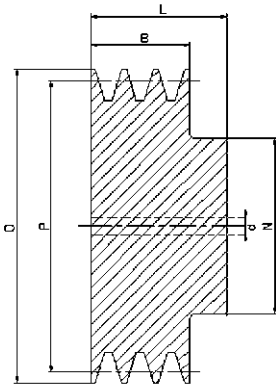

**1**

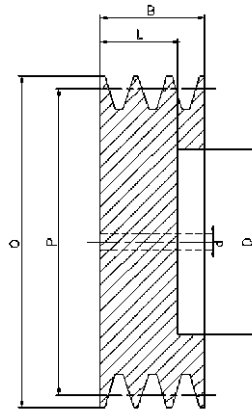

**2**

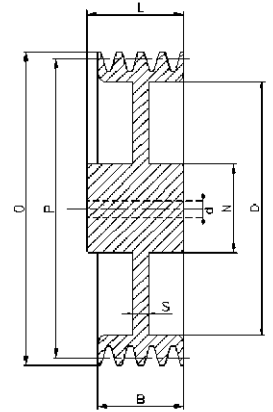

**3**

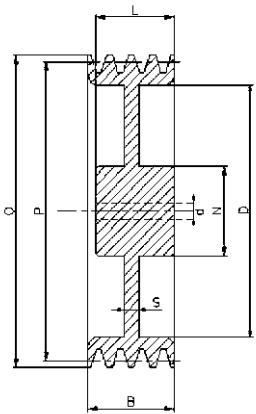

**4**

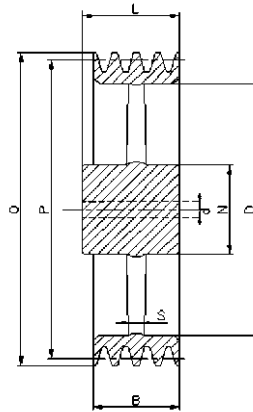

**5**

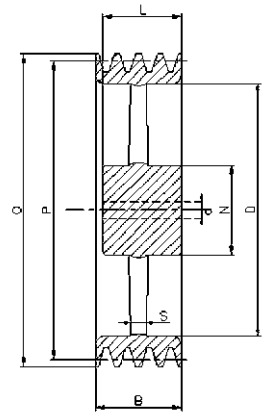

**6**

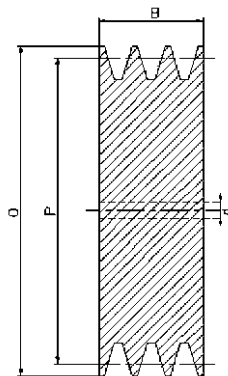

**7**

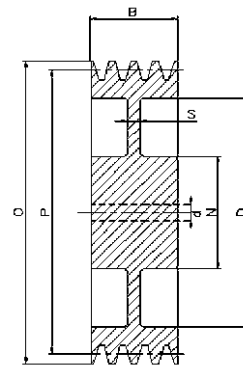

**8**

Cod. interno Internal code Innerer Code Code interne Código interno	Descrizione Description Beschreibung Description Descripción	P	O	Gole Grooves Rillen Gorges Canales	N	L	D	S	B	Forma Form Forme Forme Forma	d	Peso Weight Gewicht Poids Peso
ZM00501	SPZ50	<b>50</b>	54	1	40	28			16	1	10	
ZM00502				2	40	35			28	1	10	
ZM00503				3					40	7	10	
ZM00561	SPZ56	<b>56</b>	60	1	45	28			16	1	10	
ZM00562				2	45	35			28	1	10	
ZM00563				3					40	7	10	
ZM00631	SPZ63	<b>63</b>	67	1	50	28			16	1	10	
ZM00632				2	50	35			28	1	10	
ZM00633				3					40	7	10	
ZM00711	SPZ71	<b>71</b>	75	1	50	28			16	1	10	
ZM00712				2	55	35			28	1	10	
ZM00713				3					40	7	10	
ZM00751	SPZ75	<b>75</b>	79	1	50	28			16	1	10	
ZM00752				2	60	35			28	1	10	
ZM00753				3					40	7	10	
ZM00801	SPZ80	<b>80</b>	84	1	50	28			16	1	10	
ZM00802				2	60	35			28	1	10	
ZM00803				3					40	7	10	
ZM00851	SPZ85	<b>85</b>	89	1	50	28			16	1	10	
ZM00852				2	60	35			28	1	10	
ZM00853				3					40	7	15	
ZM00901	SPZ90	<b>90</b>	94	1	50	28			16	1	10	
ZM00902				2	60	35			28	1	10	
ZM00903				3					40	7	15	
ZM00951	SPZ95	<b>95</b>	99	1	50	28			16	1	10	
ZM00952				2	60	35			28	1	15	
ZM00953				3					40	7	15	
ZM01001	SPZ100	<b>100</b>	104	1	50	28			16	1	10	
ZM01002				2	60	35			28	1	15	
ZM01003				3					40	7	15	
ZM01061	SPZ106	<b>106</b>	110	1	50	28			16	1	10	
ZM01062				2	60	35			28	1	15	
ZM01063				3					40	7	15	
ZM01121	SPZ112	<b>112</b>	116	1	50	28			16	1	10	
ZM01122				2	60	35			28	1	15	
ZM01123				3					40	7	15	
ZM01181	SPZ118	<b>118</b>	122	1	50	28	93	8	16	3	10	
ZM01182				2	60	35	91	8	28	3	15	
ZM01183				3					40	7	15	
ZM01251	SPZ125	<b>125</b>	129	1	50	28	100	8	16	3	15	
ZM01252				2	60	35	99	8	28	3	15	
ZM01253				3					40	7	15	



Cod. interno Internal code Innerer Code Code interne Código interno	Descrizione Description Beschreibung Description Descripción	P	O	Gole Grooves Rillen Gorges Canales	N	L	D	S	B	Forma Form Forme Forme Forma	d	Peso Weight Gewicht Poids Peso
ZM01321	SPZ132	<b>132</b>	136	1	50	28	106	8	16	3	15	
ZM01322				2	60	40	106	8	28	3	15	
ZM01323				3	60	40	106	8	40	8	15	
ZM01401	SPZ140	<b>140</b>	144	1	50	28	114	8	16	3	15	
ZM01402				2	60	40	114	8	28	3	15	
ZM01403				3	60	40	114	8	40	8	15	
ZM01501	SPZ150	<b>150</b>	154	1	50	28	124	8	16	3	15	
ZM01502				2	60	40	124	8	28	3	15	
ZM01503				3	60	40	124	8	40	8	20	
ZM01601	SPZ160	<b>160</b>	164	1	55	32	134	8	16	3	15	
ZM01602				2	60	40	134	8	28	3	15	
ZM01603				3	65	45	134	8	40	3	20	
ZM01801	SPZ180	<b>180</b>	184	1	55	32	154	8	16	5	20	
ZM01802				2	60	40	154	8	28	5	20	
ZM01803				3	65	45	154	8	40	5	20	
ZM02001	SPZ200	<b>200</b>	204	1	55	32	174	8	16	5	20	
ZM02002				2	60	40	174	8	28	5	20	
ZM02003				3	65	45	174	10	40	5	20	
ZM02241	SPZ224	<b>224</b>	228	1	55	32	198	8	16	5	20	
ZM02242				2	60	40	198	8	28	5	20	
ZM02243				3	65	45	198	10	40	5	20	
ZM02501	SPZ250	<b>250</b>	254	1	55	32	224	8	16	5	20	
ZM02502				2	60	40	224	10	28	5	20	
ZM02503				3	65	45	224	12	40	5	20	
ZM02802	SPZ280	<b>280</b>	284	2	65	45	254	10	28	5	20	
ZM03152	SPZ315	<b>315</b>	319	2	65	45	289	10	28	5	20	

Cod. interno Internal code Innerer Code Code interne Código interno	Descrizione Description Beschreibung Description Descripción	P	O	Gole Grooves Rillen Gorges Canales	N	L	D	S	B	Forma Form Forme Forme Forma	d	Peso Weight Gewicht Poids Peso
AM00401	SPA40	<b>40</b>	45,5	1	40	35			20	1	10	
AM00501	SPA50	<b>50</b>	55,5	1	40	35			20	1	10	
AM00502				2	40	45			35	1	10	
AM00561	SPA56	<b>56</b>	61,5	1	40	35			20	1	10	
AM00562				2	40	45			35	1	10	
AM00563				3					50	7	10	
AM00603	SPA60	<b>60</b>	65,5	3					50	7	10	
AM00631	SPA63	<b>63</b>	68,5	1	40	35			20	1	10	
AM00632				2	40	45			35	1	10	
AM00633				3					50	7	10	
AM00711	SPA71	<b>71</b>	76,5	1	40	40			20	1	10	
AM00712				2	50	45			35	1	10	
AM00713				3					50	7	10	
AM00751	SPA75	<b>75</b>	80,5	1	40	40			20	1	10	
AM00752				2	50	45			35	1	10	
AM00753				3					50	7	10	
AM00754				4					65	7	10	
AM00755				5					80	7	10	
AM00801	SPA80	<b>80</b>	85,5	1	45	40			20	1	10	
AM00802				2	50	45			35	1	10	
AM00803				3					50	7	15	
AM00804				4					65	7	15	
AM00805				5					80	7	15	
AM00851	SPA85	<b>85</b>	90,5	1	45	40			20	1	10	
AM00852				2	50	45			35	1	10	
AM00853				3					50	7	15	
AM00854				4					65	7	15	
AM00855				5					80	7	15	
AM00901	SPA90	<b>90</b>	95,5	1	45	40			20	1	10	
AM00902				2	60	45			35	1	15	
AM00903				3					50	7	15	
AM00904				4					65	7	15	
AM00905				5					80	7	15	
AM00951	SPA95	<b>95</b>	100,5	1	45	40			20	1	10	
AM00952				2	60	45			35	1	15	
AM00953				3					50	7	15	
AM00954				4					65	7	15	
AM00955				5					80	7	15	
AM01001	SPA100	<b>100</b>	105,5	1	48	40			20	1	10	
AM01002				2	60	45			35	1	15	
AM01003				3					50	7	15	
AM01004				4		52	67		65	2	15	
AM01005				5		52	67		80	2	15	
AM01061	SPA106	<b>106</b>	111,5	1	48	40			20	1	10	
AM01062				2	60	45			35	1	15	
AM01063				3					50	7	15	
AM01065				5		52	67		80	2	15	
AM01121	SPA112	<b>112</b>	117,5	1	48	40			20	1	10	
AM01122				2	60	45			35	1	15	
AM01123				3					50	7	15	
AM01124				4		52	79		65	2	15	
AM01125				5		52	79		80	2	15	
AM01181	SPA118	<b>118</b>	123,5	1	60	40			20	1	15	
AM01182				2	60	45			35	1	15	
AM01183				3					50	7	15	
AM01184				4		52	87		65	2	15	
AM01185				5		52	87		80	2	15	

Cod. interno Internal code Innerer Code Code interne Código interno	Descrizione Description Beschreibung Description Descripción	P	O	Gole Grooves Rillen Gorges Canales	N	L	D	S	B	Forma Form Forme Forme Forma	d	Peso Weight Gewicht Poids Peso
AM01251	SPA125	<b>125</b>	130,5	1	60	40			20	1	15	
AM01252				2	60	45			35	1	15	
AM01253				3					50	7	15	
AM01254				4		52	97		65	2	15	
AM01321	SPA132	<b>132</b>	137,5	1	60	40			20	1	15	
AM01322				2	60	45			35	1	15	
AM01323				3					50	7	15	
AM01324				4		52	97		65	2	15	
AM01325				5		52	97		80	2	15	
AM01401	SPA140	<b>140</b>	145,5	1	60	40	107	10	20	3	15	
AM01402				2	60	45	107	10	35	3	15	
AM01403				3	65	52	107	18	50	3	20	
AM01404				4		52	107		65	2	20	
AM01405				5		52	107		80	2	20	
AM01501	SPA150	<b>150</b>	155,5	1	60	40	117	10	20	3	15	
AM01502				2	60	45	117	10	35	3	15	
AM01503				3	65	52	117	18	50	3	20	
AM01504				4		52	117		65	2	20	
AM01505				5		52	117		80	2	20	
AM01601	SPA160	<b>160</b>	165,5	1	60	40	127	10	20	3	15	
AM01602				2	60	45	127	10	35	3	15	
AM01603				3	70	52	127	18	50	3	20	
AM01604				4	70	52	127	22	65	4	20	
AM01605				5	80	52	127	22	80	4	20	
AM01701	SPA170	<b>170</b>	175,5	1	60	40	137	10	20	3	15	
AM01702				2	60	45	137	10	35	3	15	
AM01703				3	70	52	137	18	50	3	20	
AM01704				4	80	52	137	18	65	4	20	
AM01705				5	80	52	137	18	80	4	20	
AM01801	SPA180	<b>180</b>	185,5	1	65	40	147	10	20	3	20	
AM01802				2	70	50	147	12	35	3	20	
AM01803				3	70	52	147	12	50	3	20	
AM01804				4	80	60	147	22	65	4	20	
AM01805				5	80	65	147	22	80	4	20	
AM01902	SPA190	<b>190</b>	195,5	2	70	50	157	12	35	3	20	
AM01903				3	70	52	157	12	50	3	20	
AM01904				4	80	60	157	18	65	4	20	
AM02001	SPA200	<b>200</b>	205,5	1	65	45	167	10	20	3	20	
AM02002				2	70	50	167	12	35	3	20	
AM02003				3	70	52	167	12	50	3	20	
AM02004				4	80	60	167	18	65	4	20	
AM02005				5	80	65	167	20	80	4	20	
AM02121	SPA212	<b>212</b>	217,5	1	65	40		10	20	3	20	
AM02122				2	70	45		12	35	3	20	
AM02241	SPA224	<b>224</b>	229,5	1	65	45	192	10	20	3	20	
AM02242				2	70	50	192	12	35	3	20	
AM02243				3	80	52	192	12	50	3	20	
AM02244				4	90	60	192	18	65	4	20	
AM02245				5	90	65	192	20	80	4	20	
AM02361	SPA236	<b>236</b>	241,5	1		50		12	20	3	20	
AM02362				2		50		12	35	3	20	
AM02501	SPA250	<b>250</b>	255,5	1	75	50	217	12	20	3	20	
AM02502				2	75	50	217	12	35	3	20	
AM02503				3	80	60	217	12	50	3	20	
AM02504				4	90	65	217	18	65	3	20	
AM02505				5	90	65	217	20	80	4	20	
AM02801	SPA280	<b>280</b>	285,5	1	75	50	247	14	20	5	20	
AM02802				2	80	50	247	14	35	5	20	
AM02803				3	80	60	247	14	50	5	20	
AM02804				4	90	65	247	16	65	5	20	
AM02805				5	100	65	247	18	80	6	25	

Cod. interno Internal code Innerer Code Code interne Código interno	Descrizione Description Beschreibung Description Descripción	P	O	Gole Grooves Rillen Gorges Canales	N	L	D	S	B	Forma Form Forme Forme Forma	d	Peso Weight Gewicht Poids Peso
AM03001	SPA300	<b>300</b>	305,5	1	75	50	267	14	20	5	20	
AM03002				2	80	50	267	14	35	5	20	
AM03003				3	80	60	267	14	50	5	20	
AM03004				4	90	65	267	16	65	5	20	
AM03005				5	100	65	267	18	80	6	25	
AM03151	SPA315	<b>315</b>	320,5	1	75	60	282	14	20	5	20	
AM03152				2	80	50	282	14	35	5	20	
AM03153				3	90	60	282	14	50	5	20	
AM03154				4	90	65	282	16	65	5	20	
AM03155				5	100	65	282	18	80	6	25	
AM03551	SPA355	<b>355</b>	360,5	1	75	50	322	14	20	5	20	
AM03552				2	80	50	322	14	35	5	20	
AM03553				3	90	60	322	14	50	5	20	
AM03554				4	90	65	322	16	65	5	25	
AM03555				5	100	65	322	18	80	6	25	
AM04001	SPA400	<b>400</b>	405,5	1	90	50	367	14	20	5	20	
AM04002				2	90	50	367	14	35	5	20	
AM04003				3	100	60	367	16	50	5	25	
AM04004				4	100	65	367	20	65	5	25	
AM04005				5	100	65	367	22	80	6	25	
AM04501	SPA450	<b>450</b>	455,5	1	90	50	417	14	20	5	20	
AM04502				2	100	50	417	14	35	5	25	
AM04503				3	100	60	417	16	50	5	25	
AM04504				4	105	65	417	20	65	6	25	
AM04505				5	105	65	417	22	80	6	25	
AM05001	SPA500	<b>500</b>	505,5	1	90	50	467	14	20	5	20	
AM05002				2	100	50	467	16	35	5	25	
AM05003				3	105	60	467	20	50	5	25	
AM05004				4	105	65	467	20	65	6	25	
AM05005				5	110	65	467	22	80	6	25	
AM05601	SPA560	<b>560</b>	565,5	1	100	50	527	15	20	5	25	
AM05602				2	100	50	527	18	35	5	25	
AM05603				3	120	65	527	20	50	5	25	
AM05604				4	120	65	527	22	65	5	25	
AM05605				5	120	80	527	24	80	5	25	
AM05606				6	120	80	527	26	95	6	25	
AM06301	SPA630	<b>630</b>	635,5	1	100	50	597	16	20	5	25	
AM06302				2	110	50	597	18	35	5	25	
AM06303				3	120	65	597	20	50	5	25	
AM06304				4	120	65	597	22	65	5	25	
AM06305				5	120	80	597	24	80	5	25	
AM06306				6	120	80	597	26	95	6	25	

Cod. interno Internal code Innerer Code Code interne Código interno	Descrizione Description Beschreibung Description Descripción	P	O	Gole Grooves Rillen Gorges Canales	N	L	D	S	B	Forma Form Forme Forme Forma	d	Peso Weight Gewicht Poids Peso
BM00631	SPB63	<b>63</b>	70	1	45	45			25	1	10	
BM00701	SPB70	<b>70</b>	77	1	45	45			25	1	10	
BM00702				2	45	55			44	1	10	
BM00713	SPB71	<b>71</b>	78	3					63	7	15	
BM00801	SPB80	<b>80</b>	87	1	50	45			25	1	10	
BM00802				2	50	55			44	1	10	
BM00803				3					63	7	15	
BM00804				4					82	7	15	
BM00805				5					101	7	15	
BM00851	SPB85	<b>85</b>	92	1	50	45			25	1	10	
BM00852				2	50	55			44	1	10	
BM00853				3	-	-			63	7	15	
BM00901	SPB90	<b>90</b>	97	1	50	45			25	1	10	
BM00902				2	50	55			44	1	10	
BM00903				3					63	7	15	
BM00904				4					82	7	15	
BM00905				5					101	7	15	
BM00951	SPB95	<b>95</b>	102	1	50	45			25	1	10	
BM01001	SPB100	<b>100</b>	107	1	52	45			25	1	10	
BM01002				2	55	55			44	1	15	
BM01003				3					63	7	15	
BM01004				4					82	7	15	
BM01005				5					101	7	15	
BM01061	SPB106	<b>106</b>	113	1		45			25	1	15	
BM01062				2		55			44	1	15	
BM01121	SPB112	<b>112</b>	119	1	55	45			25	1	15	
BM01122				2	60	55			44	1	15	
BM01123				3					63	7	15	
BM01124				4					82	7	20	
BM01125				5					101	7	20	
BM01181	SPB118	<b>118</b>	125	1	55	45			25	1	15	
BM01182				2	60	55			44	1	15	
BM01183				3					63	7	15	
BM01184				4					82	7	20	
BM01185				5					101	7	20	
BM01186				6					120	7	20	
BM01201	SPB120	<b>120</b>	127	1	55	45			25	1	15	
BM01202				2	60	55			44	1	15	
BM01203				3					63	7	15	
BM01204				4					82	7	20	
BM01205				5					101	7	20	
BM01206				6					120	7	20	
BM01251	SPB125	<b>125</b>	132	1	58	45			25	1	10	
BM01252				2	60	55			44	1	15	
BM01253				3		60	83		63	2	15	
BM01254				4		60	83		82	2	20	
BM01255				5		60	83		101	2	20	
BM01256				6		60	83		120	2	20	
BM01321	SPB132	<b>132</b>	139	1	60	45			25	1	15	
BM01322				2	60	55			44	1	15	
BM01323				3		60	88		63	2	15	
BM01324				4		60	88		82	2	20	
BM01325				5		60	88		101	2	20	
BM01326				6		60	88		120	2	20	
BM01401	SPB140	<b>140</b>	147	1	65	45			25	1	20	
BM01402				2	65	55			44	1	20	
BM01403				3		60	98		63	2	20	
BM01404				4		60	98		82	2	20	
BM01405				5		60	98		101	2	20	
BM01406				6		60	98		120	2	20	
BM01501	SPB150	<b>150</b>	157	1	65	45			25	1	20	
BM01502				2	65	55			44	1	20	
BM01503				3		60	108		63	2	20	
BM01504				4		60	108		82	2	20	
BM01505				5		60	108		101	2	20	
BM01506				6		60	108		120	2	20	

Cod. interno Internal code Innerer Code Code interne Código interno	Descrizione Description Beschreibung Description Descripción	P	O	Gole Grooves Rillen Gorges Canales	N	L	D	S	B	Forma Form Forme Forme Forma	d	Peso Weight Gewicht Poids Peso
BM01601	SPB160	<b>160</b>	167	1	65	45	118	12	25	3	20	
BM01602				2	70	55	118	12	44	3	20	
BM01603				3		60	118		63	2	20	
BM01604				4		60	118		82	2	20	
BM01605				5		60	118		101	2	20	
BM01606				6		65	118		120	2	20	
BM01701	SPB170	<b>170</b>	177	1	65	45	128	12	25	3	20	
BM01702				2	70	55	128	12	44	3	20	
BM01703				3	70	60	128	30	63	4	20	
BM01704				4	70	60	128	30	82	4	20	
BM01705				5	70	60	128	30	101	4	20	
BM01706				6	70	65	128	40	120	4	20	
BM01801	SPB180	<b>180</b>	187	1	65	45	138	12	25	3	20	
BM01802				2	70	55	138	12	44	3	20	
BM01803				3	80	60	138	18	63	4	20	
BM01804				4	80	60	138	30	82	4	20	
BM01805				5	80	70	138	40	101	4	20	
BM01806				6	80	70	138	40	120	4	20	
BM01901	SPB190	<b>190</b>	197	1	65	45	148	12	25	3	20	
BM01902				2	70	55	148	12	44	3	20	
BM02001	SPB200	<b>200</b>	207	1	70	45	158	14	25	3	20	
BM02002				2	70	55	158	12	44	3	20	
BM02003				3	80	60	158	18	63	4	20	
BM02004				4	88	60	158	25	82	4	20	
BM02005				5	96	70	158	35	101	4	25	
BM02006				6	96	70	158	40	120	4	25	
BM02121	SPB212	<b>212</b>	219	1	70	45	170	14	25	3	20	
BM02122				2	77	55	170	14	44	3	20	
BM02123				3	80	60	170	18	63	4	20	
BM02124				4	88	60	170	25	82	4	20	
BM02125				5	96	70	170	30	101	4	25	
BM02126				6	104	80	170	45	120	4	25	
BM02241	SPB224	<b>224</b>	231	1	70	45	183	14	25	3	20	
BM02242				2	77	55	183	14	44	3	20	
BM02243				3	80	60	183	18	63	4	20	
BM02244				4	88	60	183	25	82	4	20	
BM02245				5	96	70	183	25	101	4	25	
BM02246				6	104	80	183	30	120	4	25	
BM02501	SPB250	<b>250</b>	257	1	70	50	208	14	25	3	20	
BM02502				2	77	55	208	14	44	3	20	
BM02503				3	80	60	208	18	63	4	20	
BM02504				4	96	65	208	25	82	4	25	
BM02505				5	104	75	208	25	101	4	25	
BM02506				6	104	80	208	25	120	4	25	
BM02801	SPB280	<b>280</b>	287	1	76	50	238	14	25	3	20	
BM02802				2	80	55	238	14	44	3	20	
BM02803				3	90	60	238	18	63	4	20	
BM02804				4	96	65	238	25	82	4	25	
BM02805				5	104	75	238	25	101	4	25	
BM02806				6	104	80	238	25	120	4	25	
BM03001	SPB300	<b>300</b>	307	1	76	50	258	15	25	5	20	
BM03002				2	80	55	258	15	44	5	20	
BM03003				3	90	60	258	18	63	6	20	
BM03004				4	96	65	258	20	82	6	25	
BM03005				5	104	75	258	22	101	6	25	
BM03006				6	104	80	258	24	120	6	25	

Cod. interno Internal code Innerer Code Code interne Código interno	Descrizione Description Beschreibung Description Descripción	P	O	Gole Grooves Rillen Gorges Canales	N	L	D	S	B	Forma Form Forme Forme Forma	d	Peso Weight Gewicht Poids Peso
BM03151	SPB315	<b>315</b>	322	1	76	50	273	15	25	5	20	
BM03152				2	88	60	273	15	44	5	20	
BM03153				3	90	60	273	18	63	6	20	
BM03154				4	96	65	273	20	82	6	25	
BM03155				5	104	75	273	22	101	6	25	
BM03156				6	120	90	273	24	120	6	25	
BM03551	SPB355	<b>355</b>	362	1	80	50	313	15	25	5	20	
BM03552				2	88	60	313	15	44	5	20	
BM03553				3	92	60	313	18	63	6	25	
BM03554				4	96	65	313	20	82	6	25	
BM03555				5	104	75	313	22	101	6	25	
BM03556				6	120	90	313	24	120	6	25	
BM04001	SPB400	<b>400</b>	407	1	85	55	358	18	25	5	20	
BM04002				2	88	60	358	18	44	5	20	
BM04003				3	96	65	358	22	63	5	25	
BM04004				4	104	75	358	24	82	6	25	
BM04005				5	112	85	358	26	101	6	25	
BM04006				6	120	100	358	28	120	6	25	
BM04253	SPB425	<b>425</b>	432	3	96	65	383	22	63	5	20	
BM04254				4	104	75	383	24	82	6	25	
BM04255				5	112	85	383	26	101	6	25	
BM04501	SPB450	<b>450</b>	457	1	90	60	408	18	25	5	20	
BM04502				2	90	60	408	18	44	5	20	
BM04503				3	96	65	408	22	63	5	25	
BM04504				4	104	75	408	24	82	6	25	
BM04505				5	112	85	408	26	101	6	25	
BM04506				6	120	100	408	28	120	6	25	
BM05001	SPB500	<b>500</b>	507	1	100	60	458	18	25	5	25	
BM05002				2	100	65	458	20	44	5	25	
BM05003				3	104	75	458	24	63	5	25	
BM05004				4	112	85	458	28	82	5	25	
BM05005				5	120	90	458	30	101	6	25	
BM05006				6	128	105	458	33	120	6	25	
BM05601	SPB560	<b>560</b>	567	1	100	60	518	18	25	5	25	
BM05602				2	100	65	518	20	44	5	25	
BM05603				3	104	75	518	24	63	5	25	
BM05604				4	112	85	518	28	82	5	25	
BM05605				5	120	90	518	30	101	6	25	
BM05606				6	128	105	518	33	120	6	25	
BM06001	SPB600	<b>600</b>	607	1	100	60	558	18	25	5	25	
BM06002				2	100	65	558	20	44	5	25	
BM06003				3	104	75	558	24	63	5	25	
BM06004				4	115	85	558	28	82	5	25	
BM06005				5	120	90	558	30	101	6	25	
BM06006				6	129	105	558	33	120	6	25	
BM06301	SPB630	<b>630</b>	637	1	100	60	588	18	25	5	25	
BM06302				2	100	65	588	20	44	5	25	
BM06303				3	105	75	588	26	63	5	25	
BM06304				4	120	85	588	28	82	5	25	
BM06305				5	128	90	588	30	101	6	25	
BM06306				6	140	105	588	33	120	6	25	

Cod. interno Internal code Innerer Code Code interne Código interno	Descrizione Description Beschreibung Description Descripción	P	O	Gole Grooves Rillen Gorges Canales	N	L	D	S	B	Forma Form Forme Forme Forma	d	Peso Weight Gewicht Poids Peso							
CM01001	SPC100	<b>100</b>	109,6	1	60	50			34,0	1	15								
CM01201	SPC120	<b>120</b>	129,6	1	65	50			34,0	1	15								
CM01202				2									59,5	7	15				
CM01401	SPC140	<b>140</b>	149,6	1	70	50			34,0	1	20								
CM01402				2									59,5	7	20				
CM01403				3									65	83	85,0	2	20		
CM01404				4									80	83	110,5	2	20		
CM01501	SPC150	<b>150</b>	159,6	1	70	50			34,0	1	20								
CM01502				2									59,5	7	20				
CM01503				3									65	93	85,0	2	20		
CM01504				4									80	93	110,5	2	20		
CM01505				5									96	93	136,0	2	20		
CM01601	SPC160	<b>160</b>	169,6	1	72	50	103		34,0	1	20								
CM01602				2									103	59,5	7	20			
CM01603				3									65	103	85,0	2	20		
CM01604				4									80	103	110,5	2	20		
CM01605				5									96	103	136,0	2	20		
CM01606				6									96	103	161,5	2	20		
CM01801	SPC180	<b>180</b>	189,6	1	76	50	123	16	34,0	3	20								
CM01802				2									80	123	30	59,5	8	20	
CM01803				3									82	65	123	35	85,0	4	20
CM01804				4									82	80	123	60	110,5	4	20
CM01805				5									82	96	123	75	136,0	4	20
CM01806				6									82	96	123	75	161,5	4	20
CM02001	SPC200	<b>200</b>	209,6	1	76	50	143	16	34,0	3	20								
CM02002				2									80	60	143	20	59,5	3	20
CM02003				3									86	65	143	25	85,0	4	20
CM02004				4									90	90	143	70	110,5	4	20
CM02005				5									90	100	143	80	136,0	4	25
CM02006				6									90	100	143	80	161,5	4	25
CM02241	SPC224	<b>224</b>	233,6	1	86	50	168	16	34,0	3	20								
CM02242				2									88	60	168	18	59,5	3	20
CM02243				3									90	70	168	21	85,0	4	20
CM02244				4									90	90	168	50	110,5	4	25
CM02245				5									90	100	168	60	136,0	4	25
CM02246				6									90	100	168	60	161,5	4	25
CM02501	SPC250	<b>250</b>	259,6	1	86	50	193	16	34,0	3	20								
CM02502				2									92	60	193	18	59,5	3	20
CM02503				3									92	70	193	21	85,0	4	20
CM02504				4									100	90	193	30	110,5	4	25
CM02505				5									102	100	193	50	136,0	4	25
CM02506				6									102	100	193	50	161,5	4	25
CM02801	SPC280	<b>280</b>	289,6	1	86	50	223	16	34,0	3	20								
CM02802				2									92	60	223	18	59,5	3	20
CM02803				3									92	70	223	21	85,0	4	20
CM02804				4									100	90	223	25	110,5	4	25
CM02805				5									102	100	223	40	136,0	4	25
CM02806				6									102	100	223	40	161,5	4	25
CM03001	SPC300	<b>300</b>	309,6	1	86	50	243	16	34,0	3	20								
CM03002				2									92	60	243	18	59,5	3	20
CM03003				3									92	70	243	21	85,0	4	20
CM03004				4									100	90	243	25	110,5	4	25
CM03005				5									104	100	243	25	136,0	4	25
CM03006				6									104	100	243	25	161,5	4	25



Cod. interno Internal code Innerer Code Code interne Código interno	Descrizione Description Beschreibung Description Descripción	P	O	Gole Grooves Rillen Gorges Canales	N	L	D	S	B	Forma Form Forme Forme Forma	d	Peso Weight Gewicht Poids Peso
CM03151	SPC315	<b>315</b>	324,6	1	92	50	258	16	34,0	5	20	
CM03152				2	92	60	258	18	59,5	5	20	
CM03153				3	92	70	258	22	85,0	6	25	
CM03154				4	110	90	258	25	110,5	4	25	
CM03155				5	112	100	258	25	136,0	4	25	
CM03156				6	112	100	258	28	161,5	4	25	
CM03351	SPC335	<b>335</b>	344,6	1	100	50	283	16	34,0	5	20	
CM03352				2	100	60	283	18	59,5	5	20	
CM03353				3	100	70	283	22	85,0	6	25	
CM03354				4	114	90	283	25	110,5	6	25	
CM03355				5	114	100	283	28	136,0	6	25	
CM03356				6	114	100	283	30	161,5	6	25	
CM03551	SPC355	<b>355</b>	364,6	1	110	50	298	16	34,0	5	20	
CM03552				2	110	60	298	18	59,5	5	25	
CM03553				3	110	70	298	22	85,0	6	25	
CM03554				4	114	90	298	25	110,5	6	25	
CM03555				5	114	100	298	28	136,0	6	25	
CM03556				6	114	100	298	30	161,5	6	25	
CM04001	SPC400	<b>400</b>	409,6	1	110	60	343	18	34,0	5	25	
CM04002				2	110	70	343	20	59,5	5	25	
CM04003				3	114	90	343	24	85,0	5	25	
CM04004				4	114	90	343	26	110,5	6	25	
CM04005				5	120	100	343	28	136,0	6	25	
CM04006				6	120	100	343	30	161,5	6	25	
CM04501	SPC450	<b>450</b>	459,6	1	110	60	393	18	34,0	5	25	
CM04502				2	110	70	393	20	59,5	5	25	
CM04503				3	114	90	393	24	85,0	5	25	
CM04504				4	120	90	393	28	110,5	6	25	
CM04505				5	120	100	393	30	136,0	6	25	
CM04506				6	120	100	393	32	161,5	6	25	
CM05001	SPC500	<b>500</b>	509,6	1	114	60	443	18	34,0	5	25	
CM05002				2	114	70	443	20	59,5	5	25	
CM05003				3	114	90	443	24	85,0	5	25	
CM05004				4	126	90	443	28	110,5	6	25	
CM05005				5	126	100	443	30	136,0	6	25	
CM05006				6	126	100	443	32	161,5	6	25	
CM05601	SPC560	<b>560</b>	569,6	1	114	60	503	20	34,0	5	25	
CM05602				2	114	70	503	24	59,5	5	25	
CM05603				3	114	90	503	28	85,0	5	25	
CM05604				4	130	100	503	30	110,5	6	25	
CM05605				5	130	100	503	32	136,0	6	25	
CM05606				6	130	100	503	35	161,5	6	25	
CM06001	SPC600	<b>600</b>	609,6	1	114	60	543	20	34,0	5	25	
CM06002				2	114	70	543	24	59,5	5	25	
CM06003				3	114	90	543	28	85,0	5	25	
CM06004				4	130	90	543	30	110,5	6	25	
CM06005				5	130	100	543	32	136,0	6	25	
CM06006				6	130	100	543	35	161,5	6	25	
CM06301	SPC630	<b>630</b>	639,6	1	114	60	573	20	34,0	5	25	
CM06302				2	114	70	573	24	59,5	5	25	
CM06303				3	114	90	573	28	85,0	5	25	
CM06304				4	130	90	573	30	110,5	6	25	
CM06305				5	130	100	573	32	136,0	6	25	
CM06306				6	130	100	573	35	161,5	6	25	