



# AGRO POWER

Application guide



Edition 1/2013



# HIGH-TECH MACHINES REQUIRE HIGH-TECH DRIVE TECHNOLOGY

The company OPTIBELT has been manufacturing drive belts in the most diverse designs since 1948 – based on over one hundred years of experience in rubber processing. Due to constant investments in material research and production technology as well as to the increasing knowledge about the basic conditions which are linked to the various application areas, the performance limits of machines have been shifted via the advancement of the belts to the high-tech drive elements of today.

## OPTIBELT AGRO POWER Quality belts made by OPTIBELT

Bigger, faster, further – extraordinary top performances have always fascinated people in all areas of technology. Again and again, engineers, scientists and researchers are going beyond the limits of feasibility.

However, what is it that drives us to develop something unique?

Why do we always want to be one step ahead of competition?

Our motivation lies in passion and precision. Brand-name products by OPTIBELT are an active investment protection for you.

As our drive belts stay invisible in your products, we add what is often missing elsewhere: responsibility and quality.

Day by day, we set examples with our top products, the OPTIBELT AGRO POWER series, and make sure that the best solution is implemented for every application. Everywhere around the world.

Passion  
meets  
precision



## HOW WE GET OUR DRIVE

OPTIBELT is characterised by this passion for technology.

Every employee adds her/his special knowledge, enthusiasm, visions and initiatives for technological advance on the highest level. That you can be sure of!

No machines without drive technology. If you imagine the modern world without drive technology, there would not be much left operating. Without drive technology machines would be unthinkable. Drive technology makes sure that the primary power of an engine is transformed for diverse working processes and thus made usable. Here, it is most important that the power of the engine is adapted to the process with help of the functional elements.

First and foremost, the belts are the central and most efficient element of it all. They stretch almost all shaft distances at comparably low costs and low maintenance. And they achieve this without lubrication or guidance elements.

Thus, drive technology with belts is far superior to roller chain drives or spur wheel sections. The diverse application areas, their adaptability and economy have made belt drives become an essential part of mechanical engineering in all sectors.

## HOW WE FOSTER OUR COMPANY VALUES

Internationally, OPTIBELT is highly estimated and represents excellent brand quality – made in Germany.

This rating is not least the result of our believe, as a family-run company, in our roots in Höxter and thus, in the location Germany.

In addition to that, the company history of OPTIBELT is closely linked with groundbreaking technical developments: from industrialisation to the automated world.

OPTIBELT has faced each of these milestones with clear sight and pioneer spirit.

This interaction of tradition and innovativeness characterises the key values of our company. For over 140 years now.

We are keeping our company philosophy even as a modern company: in our international distribution companies as well as in our production and service companies. Here, the training and further education is the key factor for the consistent quality that you can always expect from our products. Your advantage: We exceed the standards of our competitors by far and meet requirements such as just-in-time production, on-stock availability, customer proximity, support and flexibility with ease and commitment.

Because your drive drives us!

# Contents



AGCO . . . . .	12
BISO . . . . .	33
BIZON . . . . .	35
CASE INTL. HARVESTER . . . . .	36
CLAAS . . . . .	73
DEUTZ-FAHR . . . . .	203
DRONNINGBORG . . . . .	224
FELLA . . . . .	237
FENDT . . . . .	238
FORTSCHRITT . . . . .	240
GOMSELMASH . . . . .	243
GRIMME . . . . .	245
JOHN DEERE . . . . .	248
KPAB . . . . .	310
KRONE . . . . .	311
KUHN . . . . .	315
KVERNELAND . . . . .	316
KZK YENISEY . . . . .	321
LAVERDA . . . . .	323
MASSEY FERGUSON . . . . .	344
MDW . . . . .	370
MENGELE . . . . .	371
NEW HOLLAND . . . . .	372
PÖTTINGER . . . . .	405
RENAULT AGRICULTURE . . . . .	406
ROSTSELMACH . . . . .	407
SAMPO . . . . .	417
STOLL . . . . .	419
VIC . . . . .	422
ZMAJ . . . . .	423
PART NUMBER . . . . .	424
OPTIBELT SERVICE MANAGEMENT . . . . .	472

# Contents

<b>AGCO</b>	12	953	39	3400R	71
L 517	31	1400	39	3550AL	71
L 521	31	1420	40	3550R	71
L 524	32	1620	40	4330V	71
L 624	32	1640	41	5010S	71
L 626	32	1644	41	8-41	71
M 1600	32	1660	41	8-51	71
M 1620	32	1666	42	8-61-321	71
M 1630	32	1680	42	8670A - 8970A	72
MEGA 204 II	32	1688	42	8-71-431	72
MEGA 208	32	2144	43	8-91-531	72
MEGA 208 II	32	2166	43	E 516 B	72
MEGA 218	32	2188	43	E 517	72
		2365	43	JX1070C	72
<b>BISO</b>	33	2366	44	JX1075C	72
		2388	44	M 103	72
<b>BIZON</b>	35	4030	44	SENATOR	72
TC 59	35	4230	44	TD75D	72
Z 110 BS	35	4430	44	TL100	72
		4835	44		
<b>CASE INTL. HARVESTER</b>	36	5530	44	<b>CLAAS</b>	73
CASE INTL. HARVESTER	36	5635	44	COLUMBUS	86
30	36	6530	44	COMMANDOR 114	87
80	36	6635	44	COMMANDOR 114 CS	88
85	36	7635	45	COMMANDOR 115	89
95	36	CASE INTL. HARVESTER	45	COMMANDOR 115 CS	90
715	37	1400NA (FROM N°20715)	68	COMMANDOR 116	91
730	37	1400NA (TO N°20715)	68	COMMANDOR 116 CS	92
782	37	1440E	69	COMMANDOR 228	94
810	37	1460E	69	COMMANDOR 228 CS	95
815	37	1460NA (FROM N°23247)	69	CONSUL	97
820	37	1460NA (FROM N°23250)	70	CORTO 3100	97
915	38	1480 (FROM N°24000)	70	DOMINATOR 100	97
923	38	1480NA (FROM N°24000)	71	DOMINATOR 105	98
933	38	1E60NA	71	DOMINATOR 106	99
943	38	3010S	71	DOMINATOR 108 HYDR	100

# Contents

DOMINATOR 108 MECH	101	DOMINATOR 370 TYP 845	137	JAGUAR 690	159
DOMINATOR 108 VX	102	DOMINATOR 370 TYP 846	138	JAGUAR 690 SL	159
DOMINATOR 112	103	DOMINATOR 370 TYP C12	139	JAGUAR 695 SL	160
DOMINATOR 114	104	DOMINATOR 38	139	JAGUAR 70 SF	160
DOMINATOR 115	105	DOMINATOR 48	140	JAGUAR 71	160
DOMINATOR 116	106	DOMINATOR 48 SP	140	JAGUAR 75	160
DOMINATOR 118	107	DOMINATOR 56	141	JAGUAR 800	160
DOMINATOR 118 HYDR	109	DOMINATOR 58	141	JAGUAR 820	161
DOMINATOR 118 MECH	110	DOMINATOR 58 SP	142	JAGUAR 830	161
DOMINATOR 128 VX	112	DOMINATOR 66	142	JAGUAR 840	161
DOMINATOR 130	112	DOMINATOR 68	143	JAGUAR 85	161
DOMINATOR 140	113	DOMINATOR 68 R	144	JAGUAR 850	161
DOMINATOR 150	113	DOMINATOR 68 SR	145	JAGUAR 8500 C	162
DOMINATOR 202 II MEGA	113	DOMINATOR 76	145	JAGUAR 8550	162
DOMINATOR 202 MEGA	114	DOMINATOR 78	147	JAGUAR 870	162
DOMINATOR 203 II MEGA	115	DOMINATOR 80	148	JAGUAR 8700	162
DOMINATOR 203 MEGA	117	DOMINATOR 85	149	JAGUAR 890	162
DOMINATOR 204 II MEGA	119	DOMINATOR 86	150	JAGUAR 900	162
DOMINATOR 204 MEGA	120	DOMINATOR 88	150	LEXION 405	162
DOMINATOR 208 II MEGA	123	DOMINATOR 88 VX	151	LEXION 410	163
DOMINATOR 208 MEGA	124	DOMINATOR 96	152	LEXION 410 II	164
DOMINATOR 218	126	DOMINATOR 98	153	LEXION 415	165
DOMINATOR 218 II MEGA	127	DOMINATOR 98 VX	154	LEXION 420 MONTANA	165
DOMINATOR 218 MEGA	128	EUROPA	154	LEXION 430	166
DOMINATOR 350 MEGA	129	JAGUAR 60	155	LEXION 430 II	167
DOMINATOR 350 MEGA TYP 835	130	JAGUAR 675	155	LEXION 430 MONTANA	168
DOMINATOR 350 MEGA TYP 836	130	JAGUAR 675 HYDRO	155	LEXION 440	169
DOMINATOR 360 MEGA	131	JAGUAR 680	156	LEXION 440 II	170
DOMINATOR 360 MEGA TYP 845	132	JAGUAR 680 HYDRO	156	LEXION 450 II MTS	171
DOMINATOR 360 MEGA TYP 846	132	JAGUAR 682	156	LEXION 450 TERRA	172
DOMINATOR 360 MEGA TYP C12	132	JAGUAR 682 S	157	LEXION 460	172
DOMINATOR 370	134	JAGUAR 682 SL	157	LEXION 460 II	173
DOMINATOR 370 MEGA	135	JAGUAR 682S	157	LEXION 460 II MTS	174
DOMINATOR 370 MEGA TYP 845	135	JAGUAR 682SL	158	LEXION 460 TERRA	175
DOMINATOR 370 MEGA TYP 846	136	JAGUAR 685	158	LEXION 470	176
DOMINATOR 370 MEGA TYP C12	137	JAGUAR 685 SL	158	LEXION 470 MONTANA	177

# Contents

LEXION 480	178	TUCANO 340	201	MEGA 218	220
LEXION 480 II	178	TUCANO 430	202	POWERLINER 4030	220
LEXION 480 II MTS	179	TUCANO 450/440	202	POWERLINER 4035	220
LEXION 480 TERRA	180			STARLINER 4040	220
LEXION 510	181	<b>DEUTZ-FAHR</b>	203	STARLINER 4045	221
LEXION 520 MONTANA	182	M 1000	214	TOPLINER 4060	221
LEXION 530	183	M 1002	214	TOPLINER 4065	221
LEXION 530 MONTANA	184	M 1102	214	TOPLINER 4070	222
LEXION 540	185	M 1200	214	TOPLINER 4075	222
LEXION 550 MONTANA	185	M 1202	214	TOPLINER 4080	222
LEXION 560	186	M 1300	214	TOPLINER 4090	223
LEXION 560 MONTANA	187	M 1302	215	TOPLINER 8XL	223
LEXION 570	188	M 1302 H	215		
LEXION 570 MONTANA	189	M 1600	215	<b>DRONNINGBORG</b>	224
LEXION 580	190	M 1620	215	8300	224
LEXION 580 R AUSTRALIA	191	M 1630	215	DRONNINGBORG	224
LEXION 600	190	M 2385	215	D 1200	224
MATADOR - GIGANT	192	M 2480	216	D 1250	224
MATADOR - STANDARD	193	M 2780	216	D 1500	224
MEDION 310	193	M 3280	217	D 1600	225
MEDION 320	194	M 3480	217	D 1650	225
MEDION 320/310	194	M 3540	217	D 1800	225
MEDION 330	194	M 3570	218	D 1900	226
MEDION 330 HYDRO	195	M 3578	218	D 2250	226
MEDION 340	196	M 3580	218	D 2500	226
MERCATOR 50	196	M 3610	218	D 2600	227
MERCATOR 60	197	M 3630	219	D 3000 S	227
MERCATOR 75	198	M 3640	219	D 4000	227
MERCATOR S 70	198	M 600	219	D 4000 S	228
MERCUR	199	M 660	219	D 4500	228
OLDER MODELS	199	M 750	219	D 500	229
PROTECTOR	199	M 770	219	D 600	229
RAPS DOMINATOR	200	M 88	220	D 7000	229
SENATOR	200	M 88 S	220	D 7000 S	229
SF	200	M 900	220	D 7200	230
TUCANO 330/320	201	M 922	220	D 7500	231



# Contents



D 8000	231	<b>GRIMME</b>	245	2066	260
D 8000 S	232			2250	261
D 8400	232	<b>JOHN DEERE</b>	248	2254	261
D 8500	233	330	248	2256	261
D 8700	233	430	248	2258	262
D 8900	234	530	248	2264	263
D 900	234	630	248	2266	263
D 9000	235	730	249	2270	264
D 950	235	930	249	2280	264
MF 27	236	940	249	3300	264
MF 29	236	950	250	3400	264
MF 30	236	952	250	3430	264
MF 31	236	955	250	3830	264
MF 32	236	960	251	4400	264
MF 38	236	965	251	4420	264
		970	251	4425	265
<b>FELLA</b>	237	975	251	4700	265
		985	252	6600	265
<b>FENDT</b>	238	1032	252	6602	265
5250	238	1042	252	6610	265
6300	238	1052	253	6620	266
6330	238	1055	253	6622	266
8300	239	1065	253	6650	266
		1068	254	6700	266
<b>FORTSCHRITT</b>	240	1072	254	6710	266
E 514	240	1075	255	6750	266
E 516	241	1085	255	6810	266
E 516 B	241	1088	255	6950	266
E 517	241	1155	256	7700	267
E 524	242	1157	256	7720	268
E 525	242	1158	256	7721	268
E 527	242	1170	256	7722	268
		2054	257	8820	269
<b>GOMSELMASH</b>	243	2056	257	9400	270
MEGA 218 II	244	2058	258	9410	270
		2064	259	9450	270



9500	271	9660 STS	295	MCS SYSTEM FOR ZTRAK W/60"	305
9501	271	9670 STS	296	MCS SYSTEM FOR Z-TRAK W/60"	305
9510	272	9750 STS	297	MCS SYSTEM FOR ZTRAK W/60IN	305
9540	272	9760 STS	298	MCS SYSTEM FOR Z-TRAK W/60IN	305
9550	272	9770 STS	298	MULCH ON DEMAND DECK OPTIO	
9560	273	9860 STS	299	FOR ZTRAK W/60IN	305
9580	273	9870 STS	299	MULCH ON DEMAND DECK OPTION	
9600	273	CTS	300	FOR Z-TRAK W/60IN	305
9610	274	CTS 2	301	MULCH ON DEMAND DECK W/60"	305
9640	274	S 690	301	V-FLEX 7-IRON	305
9650	274	T 550	301	Z710A Z-TRAK SERIES MOWER	305
9660	275	T 560	302	Z720A Z-TRAK SERIES W/60IN	305
9680	275	T 660	302	Z910A Z-TRAK PRO SERIES MOWER	306
9880	276	T 670	302	Z915B W/48IN	306
9935	276			Z915B W/54IN	306
9980	276	<b>JOHN DEERE - TURF N CARE</b>	304	Z920A Z-TRAK PRO SERIES MOWER	306
JOHN DEERE	276	737 Z-TRAK AC GAS ENGINE W/54"	304	Z920A Z-TRAK PRO MOWER W/48IN	306
1072 - 1075 - 1075 HYDRO 4	288	737 Z-TRAK AC GAS ENGINE W/54IN	304	Z920A Z-TRAK PRO MOWER W/54IN	306
1075 HYDRO 4	289	737 Z-TRAK AC GAS ENGINE W/60"	304	Z920A Z-TRAK PRO MOWER W/60IN	306
1085 - 1085 HYDRO 4	289	737 Z-TRAK AC GAS ENGINE W/60IN	304	Z920M W/48IN	306
1166 - 1166 HYDRO 4	289	757 Z-TRAK AC GAS ENGINE W/54	304	Z920M W/54IN	306
1169 - 1169 HYDRO 4	290	757 Z-TRAK AC GAS ENGINE W/54IN	304	Z920M W/60IN	306
1174 - 1174 HYDRO 4	290	757 Z-TRAK AC GAS ENGINE W/60	304	Z920R W/48IN	307
1177 - 1177 HYDRO 4	291	757 Z-TRAK AC GAS ENGINE W/60IN	304	Z920R W/54IN	307
1188 - 1188 HYDRO 4	291	777 Z-TRAK	304	Z925A Z-TRAK PRO SERIES MOWER	307
4435 - 4435 HYDRO	292	777 Z-TRAK W/60IN	304	Z925A Z-TRAK EFI PRO SERIES	307
6600 SIDEHILL	292	777 Z-TRAK W/72IN	304	Z925A Z-TRAK EFI PRO SERIES MOWER	307
6700 S	292	797 Z-TRAK	304	Z925A Z-TRAK PRO MOWER W/54IN	307
9500 SH	292	797 Z-TRAK W/60IN	304	Z925A Z-TRAK PRO MOWER W/60IN	307
9510 SH	293	797 Z-TRAK W/72IN	304	Z925M-EFI W/54IN	307
9550 SH	293	MCS SYSTEM FOR Z-TRAK	304	Z925M-EFI W/60IN	307
9560 STS	293	MCS SYSTEM FOR Z-TRAK	304	Z930A W/60IN	307
9570 STS	294	MCS SYSTEM FOR ZTRAK W/54"	305	Z930A W/72IN	307
965 HYDRO 4	294	MCS SYSTEM FOR Z-TRAK W/54"	305	Z930A Z-TRAK PRO MOWER W/60IN	307
9650 CTS	295	MCS SYSTEM FOR ZTRAK W/54IN	305	Z930A Z-TRAK PRO MOWER W/72IN	308
9650 STS	295	MCS SYSTEM FOR Z-TRAK W/54IN	305	Z930M EFI MOWERIN	308



Z930M EFI W/60IN	308	3400	323	L 627 - INTEGRALE	339
Z930M W/60IN	308	3500	323	L 627 - MCS	339
Z930M W/72IN	308	3550	324	L517	340
Z930R	308	3600	324	L518	340
Z950A W/60IN	308	3650	324	L520	340
Z950A W/72IN	308	3700	325	L521	340
Z950A Z-TRAK PRO MOWER W/60IN	308	3750	325	L523-INTEGRALE	340
Z950A Z-TRAK PRO MOWER W/72IN	308	3790	325	L523-MCS	340
Z950R W/60IN	308	3850	326	L524	340
Z950R W/72IN	308	3890	326	L525-INTEGRALE	340
Z960A W/60IN	308	3900	326	L525-MCS	341
Z960A W/72IN	308	LAVERDA	326	L624	341
Z960A Z-TRAK PRO MOWER W/60IN	309	3300 AL	328	L625	341
Z960A Z-TRAK PRO MOWER W/72IN	309	3350 (EX AL 112)	328	L626	341
Z960R W/60IN	309	3350 (EX M 112)	329	L627-INTEGRALE	341
Z960R W/72IN	309	3400 R	329	L627-MCS	341
Z970A W/72IN	309	3450 (EX AL 132)	329	M 100	341
Z970R	309	3500 R	329	M 100 AL	341
		3550 AL	330	M 112	341
<b>KPAB</b>	310	3550 R	330	M 112 AL	341
		3560 AL	331	M 120	342
<b>KRONE</b>	311	3560AL	331	M 132	342
BIG X 1000	313	3650 R	331	M 150	342
BIG X 500	314	3750 R	331	M 152	342
BIG X 650	314	L 517	331	M 84	342
BIG X 800	314	L 518	332	M 90	342
		L 520	333	M 92	342
<b>KUHN</b>	315	L 521	333	MX 240	342
		L 523 - INTEGRALE	334	MX 240 R	342
<b>KVERNELAND</b>	361	L 523 - MCS	334	MX 300	342
		L 524	335	MX 300 R	343
<b>KZK YENISEY</b>	321	L 525 - INTEGRALE	336	MX240	343
		L 525 - MCS	336	MX240R	343
<b>LAVERDA</b>	323	L 624	337	MX300	343
3200	323	L 625	338	MX300R	343
3300	323	L 626	338		



<b>MASSEY FERGUSON</b>	344	3640	354	86 (F)	363
24	344	5650	354	86 OLD	363
27	344	8560	355	87 (F)	364
29	344	8570	356	87 OLD	364
31	344	8780	356	CHALLENGER 660	364
187	344	9720	356	CHALLENGER 660 B	364
206	344	186 (F)	356	CHALLENGER 670	365
240	345	186 OLD	356	CHALLENGER 670 B	365
300	345	206 OLD	357	CHALLENGER 680 B	366
307	345	307 OLD	357	MF 27	366
400	345	3640 ADVANCED	357	MF 29	366
440	346	400 - 500	357	MF 30	367
487	346	400 - 500 OLD	357	MF 31	367
500	346	410 - 415	357	MF 32	368
507	346	410 - 415 - 510 - 515 OLD	358	MF 34	368
510	346	410 - 510	358	MF 38	368
515	347	487 - 506 - 507	358		
520	347	487 OLD	358	<b>MDW</b>	370
525	347	506 OLD	358		
530	348	507 OLD	359	<b>MENGELE</b>	371
535	348	520 - 525	359		
540	348	520 OLD	359	<b>NEW HOLLAND</b>	372
550	348	525 OLD	359	1520	372
560	349	530 S	360	1530	372
565	349	5650 ADVANCED	360	1540	372
620	349	5650 TURBO	360	1545	373
625	350	620 - 625	360	1550	373
660	350	620 OLD	360	8030	373
665	350	625 OLD	361	8040	373
750	351	630 OLD	361	8050	374
755	351	630 S OLD	361	8055	374
760	352	685 OLD	361	8060	375
850	352	685 S OLD	362	8070	375
855	353	750 OLD	362	8080	376
860	353	760 - 765	362	9630	376
865	354	760 OLD	363	9640	376



9645	376	FX 375	392	TR 97	401
NEW HOLLAND	376	FX 450	392	TR 98	401
1540 AL	377	M 103	392	TX 30	402
CR 9060	377	M 122	392	TX 32	403
CR 9060 ELEVATION	377	M 133	393	TX 34	403
CR 9070 ELEVATION	378	M 135	393	TX 62	404
CR 9080	378	M 140	393		
CR 9080 ELEVATION	378	M 80	393	<b>PÖTTINGER</b>	405
CR 960	379	M 89	394		
CR 980	379	TC 5040	394	<b>RENAULT AGRICULTURE</b>	406
CR960	379	TC 5050	394		
CS 520	379	TC 5060	395	<b>ROSTSELMACH</b>	407
CS 540	380	TC 5070	395	ACROS 530	408
CS 6050	380	TC 5080	395	DON 1500 A	409
CS 6070	381	TC 52	396	DON 1500 B	410
CS 6080	381	TC 54	396	DON 680	412
CS 6090	382	TC 56	396	NIVA CK-5M-1-75(79)/77(81)	413
CS 640	382	TC 57	397	VECTOR	415
CS 660	383	TF 42	397		
CSX 7060	383	TF 44	397	<b>SAMPO</b>	417
CSX 7080	384	TF 46	398		
CX 720	384	TF 76	398	<b>STOLL</b>	419
CX 740	385	TF 78	399		
CX 760	385	TL80	399	<b>VIC</b>	422
CX 780	386	TL90	399		
CX 8030	386	TN60VA	399	<b>ZMAJ</b>	423
CX 8040	387	TN65V	399		
CX 8050	387	TN70VA	399		
CX 8060	388	TN75VA	399		
CX 8080	388	TN95VA	399		
CX 8090	389	TR 70	399		
CX 820	389	TR 75	399		
CX 840	390	TR 85	400		
CX 860	390	TR 86	400		
CX 880	391	TR 95	401		
FX 300	391	TR 96	401		

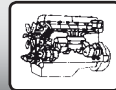

## AGCO

	6900	1	1002580	4014486495591
	10487	1	1001350	4014486474633
	56325	1	1000577	4014486468922
	270412	1	1001799	4014486488074
	270791	1	1001817	4014486488326
	290331	1	1001051	4014486484380
	400875	1	No AP	
	432244	1	1000224	4014486462913
	432433	1	1000684	4014486470628
	433128	1	1000103	4014486461053
	433417	1	1003272	4014486468762
	433435	1	1000702	4014486470857
	433440	1	1000724	4014486471168
	433442	1	1000755	4014486471557
	433531	1	1000950	4014486474053
	433537	1	1000959	4014486474169
	434140	1	1000999	4014486497229
	435125	2	1001174	4014486497465
	435127	2	1001175	4014486497472
	526155	1	1001953	4014486490589
	526369	3	1000286	4014486520194
	526370	4	1002751	4014486464689
	527975	1	1001959	4014486490671
	527976	4	1002752	4014486465150
	703899	1	1001461	4014486459708
	761757	4	1002753	4014486465136
	765173	1	1003594	4014486485004
	765174	1	1001597	4014486485165
	855007	1	1000740	4014486471366
	855122	1	1001185	4014486490237
	855650	4	1002754	4014486519983
	855718	1	1001281	4014486474473
	855791	1	1000817	4014486472424
	856047	1	1001824	4014486488432
	856112	1	1001011	4014486487930
	856401	1	1000646	4014486470062
	856641	3	1002858	4014486469769
	857219	1	1000703	4014486470871
	1141641	1	1001865	4014486489057
	1710292	1	1001282	4014486474497
	4311315	1	1001975	4014486490923
	4311316	1	1001976	4014486490930
	6153386	1	1004633	4014486719956
	6153715	1	1004547	4014486719680
	6153723	1	1004632	4014486719949
	6154285	1	1004600	4014486717938
	6154998	1	1001719	4014486487015
	6159053	1	1001768	4014486487534
	6801631	1	1004791	4014486719482
	7855331	1	1000649	4014486470109
	7855349	1	1001609	4014486485363
	7855810	1	1001878	4014486489262
	26732797	1	1002193	4014486477412
	26732815	1	1001902	4014486489620
	26732820	1	1001749	4014486487329

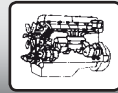

## AGCO

	26732833	1	1000794	4014486472134
	26732883	1	No AP	
	26732883	1	No AP	
	26733247	1	1003410	4014486463477
	26733248	1	1000343	4014486465921
	26733312	1	1001223	4014486497786
	26733578	3	1002759	4014486465013
	26733588	2	1002762	4014486465570
	26733596	3	1002763	4014486464290
	26735939	1	1001637	4014486485868
	26746958	3	1002852	4014486464498
	26746970	1	1000350	4014486466065
	26746971	1	1000434	4014486467017
	26746972	1	1000825	4014486472516
	26746973	1	1002028	4014486491630
	26746995	1	1001863	4014486489026
	26746996	1	1001075	4014486496598
	26746997	1	1001074	4014486496581
	26746998	1	1004647	4014486721409
	26749057	1	1001269	4014486492354
	28263409	1	1004859	4014486720570
	28284841	1	1000764	4014486471670
	41900000	1	1000037	4014486460742
	41903400	1	1000092	4014486460902
	41903700	1	1003739	4014486495645
	41903800	1	1003722	4014486494990
	41904200	1	1003706	4014486494518
	41904300	1	1003708	4014486494563
	41905600	1	1000116	4014486461251
	41907500	1	1000128	4014486461428
	41907800	1	1000134	4014486461503
	41910400	1	1000141	4014486461589
	41916800	1	1000181	4014486462104
	41921700	1	1002369	4014486479041
	41924700	1	1003334	4014486462586
	41925200	1	1000211	4014486462593
	41926500	1	1000235	4014486463361
	41928400	1	1000243	4014486463613
	41929400	1	1000252	4014486463941
	41930600	1	1000262	4014486464184
	41931100	1	1000287	4014486464733
	41931600	1	1000272	4014486464429
	41933400	1	1000298	4014486464931
	41933900	2	1002767	4014486464948
	41936300	1	1000321	4014486465419
	41936500	1	1003453	4014486465686
	41936800	2	1002771	4014486465631
	41938000	1	1003457	4014486465976
	41941100	1	1000392	4014486466553
	41941900	1	1000351	4014486466089
	41943600	1	1000414	4014486466775
	41944700	1	1004840	4014486715446
	41951700	1	1003487	4014486468342
	41953300	1	1003508	4014486469240
	41954300	1	1003529	4014486470291

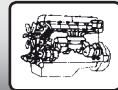

## AGCO

	41955500	1	1003544	4014486470963
	41956500	1	1003550	4014486471908
	41957500	1	1000673	4014486470444
	41958600	1	1000860	4014486472943
	41963800	1	1000241	4014486463552
	41965100	1	1003431	4014486464313
	41973000	1	1001356	4014486474701
	41976200	1	1001359	4014486474732
	41977600	1	1001726	4014486487091
	41977700	1	1001669	4014486486339
	41977800	1	1001666	4014486486292
	41977900	1	1001728	4014486487121
	41978300	1	1001250	4014486492064
	41978600	1	1001365	4014486474794
	41978700	1	1001732	4014486487169
	41981400	1	1001437	4014486459456
	41981500	1	1001538	4014486460575
	41982000	4	1002860	4014486469646
	41982300	4	1002862	4014486469431
	41982600	1	1000669	4014486470376
	41983200	1	1000809	4014486472325
	41983300	5	1002863	4014486520064
	41984900	2	1002864	4014486471083
	41985400	1	1000839	4014486472677
	41985700	1	1000694	4014486470734
	41985900	1	1000648	4014486470093
	41987400	1	1000866	4014486473049
	41987500	1	1000874	4014486473148
	41988600	1	1000900	4014486473469
	41989000	1	1000910	4014486473575
	41989800	1	1000905	4014486473513
	41990011	1	1002362	4014486478969
	41990012	1	1002328	4014486478570
	41990013	2	1003770	4014486495300
	41990014	1	1002335	4014486478679
	41990019	1	1002359	4014486478938
	41990020	1	1002324	4014486478525
	41990021	1	1002339	4014486478723
	41990022	1	1002338	4014486478709
	41990026	1	1002361	4014486478952
	41990037	1	1003565	4014486473599
	41990045	1	1001947	4014486490510
	41990047	1	1001677	4014486486445
	41990048	1	1001722	4014486487053
	41990049	1	1001675	4014486486407
	41990053	1	1001874	4014486489187
	41990054	1	1001812	4014486488241
	41990055	1	1001816	4014486488319
	41990056	1	1003658	4014486490473
	41990058	1	1001945	4014486490459
	41990060	1	1001254	4014486492118
	41990061	1	1001946	4014486490480
	41990062	1	1004092	4014486519822
	41990063	1	1001815	4014486488302
	41990065	1	1001992	4014486491159





## AGCO

	41990700	1	1002571	4014486495379
	41990800	2	1002945	4014486495492
	41991100	1	1002355	4014486478884
	41992000	1	1003604	4014486485523
	41992300	1	1001614	4014486485448
	41993800	1	1001950	4014486490558
	41994500	1	1002001	4014486491272
	41995000	1	1002070	4014486475531
	41997500	1	1002185	4014486477290
	41997900	1	No AP	
	41999100	1	1002345	4014486478785
	45055100	1	1002051	4014486475289
	46301055	1	1002268	4014486478365
	46301057	1	1002556	4014486494983
	46488200	1	1001046	4014486498165
	49906200	1	1002056	4014486475333
	70260149	1	1002604	4014486496116
	70267630	2	1002987	4014486496215
	70268485	1	1002559	4014486495072
	70273193	1	1002740	4014486496222
	71132108	1	1001093	4014486496758
	71135618	1	1001395	4014486459005
	71139963	1	1001447	4014486459555
	71140808	1	1004745	4014486720327
	71146271	1	1003607	4014486485721
	71147547	1	1001567	4014486484700
	71157414	1	1001490	4014486460001
	71161595	1	1001605	4014486485318
	71161596	1	1001623	4014486485578
	71164177	1	1003610	4014486485912
	71164350	1	1001498	4014486460117
	71165927	1	No AP	
	71167114	1	1001521	4014486460407
	71167409	1	1001661	4014486486179
	71170490	1	1001475	4014486459852
	71175575	1	1001585	4014486484953
	71175687	1	1000073	4014486483932
	71175989	1	1003603	4014486485424
	71176492	1	1000253	4014486463989
	71177537	1	1001856	4014486488913
	71187728	1	1001386	4014486475029
	71187779	1	1000577	4014486468922
	71193749	1	1002557	4014486495010
	71197876	1	1001500	4014486460148
	71197999	1	1003636	4014486488821
	71300867	1	1000800	4014486472196
	71300996	1	1001495	4014486460087
	71302482	2	1002946	4014486494938
	71309140	1	1001558	4014486484571
	71309150	2	1000391	4014486466546
	71309685	1	1001057	4014486484441
	71310380	1	1001387	4014486475036
	71310381	1	1001972	4014486490855
	71310382	1	1001638	4014486485882
	71313804	1	1000280	4014486464566



## AGCO

	71317254	2	1002947	4014486495911
	71320449	2	1000379	4014486466423
	71322828	1	1000705	4014486470901
	71322834	1	1000691	4014486470703
	71324690	1	1000683	4014486470604
	71325150	2	1002775	4014486466003
	71335475	1	1000790	4014486472066
	71335788	1	No AP	
	71339886	1	1000593	4014486469202
	71347560	1	1000422	4014486466850
	71347561	1	1000353	4014486466102
	71348989	1	1002035	4014486491715
	71348999	1	1001921	4014486489897
	71355170	1	1000420	4014486466836
	71355232	1	1001660	4014486486162
	71356409	1	1000639	4014486469974
	71358255	1	1001653	4014486486063
	71359598	1	1000699	4014486470826
	71363802	1	1003646	4014486489248
	71364077	1	1001052	4014486484397
	71364155	1	1000783	4014486471960
	71364514	2	1000396	4014486466591
	71364922	1	1000588	4014486469110
	71366207	1	1001918	4014486489859
	71367459	1	1001384	4014486475005
	71367469	1	1001601	4014486485233
	71368135	1	1002030	4014486491654
	71368809	1	No AP	
	71370214	1	1002034	4014486491692
	71370279	1	1002031	4014486491661
	71374276	1	1001862	4014486489019
	71374305	1	No AP	
	71374306	1	1001390	4014486475081
	71376238	1	No AP	
	71377787	1	1001775	4014486487619
	71380485	1	1001923	4014486489910
	71386695	1	1001389	4014486475067
	71390209	1	1003358	4014486488463
	71390561	1	1003717	4014486519693
	71390885	1	No AP	
	71390885	1	No AP	
	71390886	1	No AP	
	71390886	1	No AP	
	71398366	1	1000588	4014486469110
	71399514	1	No AP	
	71399562	1	1001876	4014486489231
	71418976	1	1003716	4014486519839
	71427254	1	1004476	4014486715750
	71427343	1	1004625	4014486717570
	71430816	1	1004590	4014486717822
	71432619	1	No AP	
	71434213	1	No AP	
	71440983	1	No AP	
	71440993	1	1004560	4014486721294
	71440999	1	1004515	4014486717259

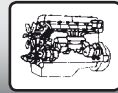

## AGCO

	71441879	1	1004582	4014486717747
	71441902	1	1004558	4014486721270
	71442230	1	1004514	4014486717242
	71442255	1	1004517	4014486718270
	71444986	1	1003718	4014486519365
	71447313	1	No AP	
	71447314	1	1004482	4014486715811
	71447401	1	1004525	4014486718324
	71448482	1	1004047	4014486519068
	71448483	1	1001389	4014486475067
	71448503	1	No AP	
	71448508	1	1001769	4014486519600
	71448515	1	1004599	4014486717921
	71449576	1	1004527	4014486717303
	71462784	1	1004521	4014486717273
	71462787	1	1003888	4014486486575
	71464666	1	No AP	
	72501439	1	1003730	4014486495287
	84175580	1	1004042	4014486519464
	87041732	1	1004060	4014486518771
	87583785	1	1003979	4014486518405
	201108473	1	1002321	4014486480092
	201108520	1	1003503	4014486469103
	340433045	1	1002460	4014486493436
	340433109	1	1000087	4014486460841
	340433119	1	1000095	4014486460933
	340433237	1	1002758	4014486463156
	340433238	1	1000210	4014486462562
	340433240	1	1000212	4014486462647
	340433242	1	1000213	4014486462685
	340433251	1	1000229	4014486463118
	340433257	1	1002779	4014486463057
	340433476	1	1000583	4014486469035
	340433477	1	1003469	4014486518788
	340433988	1	1003855	4014486474671
	340435126	1	1001474	4014486459845
	344311234	1	1003849	4014486489842
	344311235	1	1003850	4014486489149
	344311237	1	1003853	4014486488388
	344311311	1	1003918	4014486490626
	344311313	1	1003919	4014486491517
	344311322	1	1002015	4014486491487
	344312129	1	1003851	4014486519587
	684101000	1	1002453	4014486493351
	684101025	1	1002455	4014486493375
	684101050	1	1002456	4014486493399
	684101100	1	1002459	4014486493429
	684101125	1	1002460	4014486493436
	684101150	1	1002462	4014486493467
	684101175	1	1002465	4014486493504
	684101225	1	1002471	4014486493573
	684101238	1	1004876	4014486719840
	684101350	1	1002483	4014486493801
	684120825	1	1002507	4014486494129
	684120875	1	1002512	4014486494204

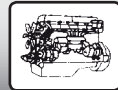

## AGCO

	684120900	1	1002514	4014486494266
	684120918	1	1002415	4014486494280
	684120925	1	1002515	4014486494297
	684120950	1	1004851	4014486716542
	684120975	1	1002520	4014486494358
	684120992	1	1004773	4014486716559
	684121050	1	1002529	4014486494488
	684121075	1	1002532	4014486494525
	684121100	1	1002534	4014486494556
	684121125	1	1002537	4014486494600
	684121200	1	1002547	4014486494778
	684121225	1	1002549	4014486494815
	684121250	1	1002549	4014486494815
	684121250	1	1002551	4014486494846
	684121275	1	1002554	4014486494914
	684121300	1	1002556	4014486494983
	684121325	1	1002558	4014486495034
	684121350	1	1002560	4014486495102
	684121375	1	1002562	4014486495157
	684121400	1	1003730	4014486495287
	684121425	1	1003733	4014486495386
	684121450	1	1002575	4014486495478
	684121475	1	1002579	4014486495560
	684121500	1	1002582	4014486495638
	684121525	1	1002584	4014486495706
	684121550	1	1002586	4014486495775
	684121575	1	1002588	4014486495812
	684121600	1	1002589	4014486495836
	684121625	1	1002593	4014486495904
	684121650	1	1003746	4014486495928
	684121675	1	1002594	4014486495942
	685061555	1	1004861	4014486719550
	685061675	1	1004863	4014486719574
	685061725	1	1004864	4014486719581
	685061740	1	1004865	4014486719598
	685061755	1	No AP	
	685061755	1	No AP	
	685081290	1	1004869	4014486716351
	685081315	1	1004870	4014486716368
	685081660	1	1003158	4014486481204
	685081680	1	1003160	4014486481242
	685081710	1	1003162	4014486481341
	685081730	1	1002656	4014486481396
	685081745	1	1002658	4014486481433
	685081785	1	No AP	
	685081800	1	1003813	4014486481501
	685081850	1	1003177	4014486481587
	685081895	1	1003183	4014486481662
	685081920	1	1002662	4014486481747
	685082300	1	1003217	4014486482454
	685102194	1	1004317	4014486715965
	685121370	1	1004339	4014486716009
	685121530	1	1003067	4014486484083
	685121555	1	1004341	4014486716023
	685121570	1	1004342	4014486716030

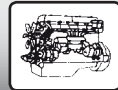

## AGCO

	685121610	1	1004343	4014486716047
	685121725	1	1003074	4014486484151
	685121765	1	1004344	4014486716054
	685121845	1	1004345	4014486716061
	685121860	1	1004829	4014486716078
	685121880	1	1004829	4014486716078
	685121905	1	1004687	4014486716085
	685121945	1	1004346	4014486716092
	685121965	1	1004347	4014486716108
	685122020	1	1004348	4014486716115
	685122140	1	1003954	4014486484267
	685141585	1	1004390	4014486716177
	700705430	1	1001283	4014486474503
	700705503	3	1001284	4014486474510
	700705773	2	1002776	4014486463101
	700708547	1	1002629	4014486481211
	700711852	1	1001671	4014486486353
	700714423	2	1002866	4014486470758
	700715554	1	1002657	4014486481419
	700717275	1	No AP	
	700719205	1	1004852	4014486718300
	700719689	4	1004359	4014486714036
	700721267	1	1004601	4014486717945
	836007765	1	1000201	4014486462395
	3443111171	1	1001577	4014486484946
	3443111278	1	1001637	4014486485868
	228999M1	1	1000251	4014486463897
	320593M2	1	1001361	4014486474756
	320623M2	1	1003438	4014486464894
	321034M3	1	1000337	4014486465839
	322768M1	1	1003482	4014486468182
	402177M1	1	1003399	4014486462937
	402603M1	1	1003459	4014486466058
	405928M1	1	1003463	4014486466959
	410647M1	1	1001363	4014486474770
	411020M1	1	1000193	4014486462265
	411218M1	1	1001065	4014486496499
	412333M1	1	1003574	4014486497403
	418209M1	1	1003493	4014486468489
	511275M1	1	1000150	4014486461695
	515382M1	1	1001023	4014486487848
	515383M1	1	1001024	4014486487855
	523735M1	1	1000146	4014486461640
	603719M1	1	1001406	4014486459135
	624728M1	1	1000031	4014486460681
	832790M3	1	1001444	4014486459524
	832866M2	1	1000826	4014486472523
	843302M1	1	1003557	4014486472660
	843324M1	1	1000808	4014486472318
	903594M2	1	1003392	4014486462678
	905982M1	1	1001479	4014486459890
	916801M2	1	1000641	4014486470000
	916854M1	1	1000385	4014486466485
	962666M1	1	1002467	4014486493535
	1604055M2	1	1003484	4014486468281

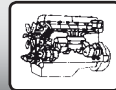

## AGCO

	1604401M1	1	1000370	4014486466331
	1615962M1	1	1000760	4014486471618
	1686837M1	1	No AP	
	1720674M2	1	1000221	4014486462852
	1730367M1	1	1000877	4014486473179
	1731014M1	1	1000668	4014486470352
	3021251M1	1	1000142	4014486461596
	3036551M1	1	1003648	4014486489293
	3049010M91	1	No AP	
	3101337M1	1	1003431	4014486464313
	3170530M1	1	1000841	4014486472707
	3170531M1	1	1000795	4014486472141
	3172001M1	1	1000827	4014486472547
	3371438M1	1	1000846	4014486472752
	3371643M1	1	No AP	
	3373171M2	1	1003505	4014486469196
	3380422M1	1	No AP	
	3387555M1	1	No AP	
	3714575M1	1	No AP	
	3778297M1	1	No AP	
	3780607M91	1	No AP	
	4273269M1	1	No AP	
	4275185M91	1	1002523	4014486494419
	4282444M1	1	1004195	4014486675962
	0000055574	1	1003516	4014486469677
	0000056325	1	1000577	4014486468922
	0000290331	1	1001051	4014486484380
	0000400875	1	No AP	
	0000765173	1	1003594	4014486485004
	0000765174	1	1001597	4014486485165
	0000855007	1	1000740	4014486471366
	0000855650	4	1002754	4014486519983
	0000855791	1	1000817	4014486472424
	0000856401	1	1000646	4014486470062
	0000856641	3	1002858	4014486469769
	0000857219	1	1000703	4014486470871
	0006902	1	1004159	4014486523379
	0006906	1	1002558	4014486495034
	0006907	1	1002559	4014486495072
	0007855331	1	1000649	4014486470109
	0007855349	1	1001609	4014486485363
	0007855356	2	1002756	4014486463163
	021077T1	2	1004721	4014486716719
	021078T1	1	1002598	4014486496031
	026160T1	2	1002950	4014486495652
	026161T1	1	1002582	4014486495638
	034699T1	2	1004715	4014486716665
	034948T1	1	1004716	4014486716658
	038355T1	1	1000080	4014486484014
	039631T1	1	1003920	4014486485189
	048392T1	1	1000695	4014486470765
	049798T1	1	1002543	4014486494723
	049798T1	2	1004880	4014486716627
	053640T1	1	1001510	4014486460278
	053650T1	2	1002932	4014486493917

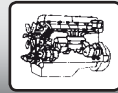

## AGCO

	053928T1	1	1000652	4014486470154
	054269T1	2	1002971	4014486495423
	054315T1	2	1002487	4014486493894
	054607T1	1	1002534	4014486494556
	0554093.0	1	1004100	4014486520590
	055574	1	1003516	4014486469677
	056148T1	1	1002464	4014486493498
	056149T1	1	1002582	4014486495638
	056150T1	1	1002444	4014486493221
	058147P1	1	1003367	4014486460971
	059105T1	1	1001996	4014486491203
	059106T1	1	1001499	4014486460131
	059169R1	1	1002519	4014486494341
	06154847	1	1000108	4014486461121
	06155819	1	1000654	4014486470178
	063211T1	1	1001571	4014486484748
	063212T1	1	1001621	4014486485530
	064441T1	1	1001467	4014486459777
	065188T1	1	1003921	4014486485509
	068154T1	1	1003922	4014486485707
	068918T1	1	1001620	4014486485516
	069361T1	1	1001513	4014486460322
	069362T1	1	1004888	4014486720334
	069998T1	2	1002934	4014486493962
	069999T1	2	1002918	4014486493993
	070460T1	1	1002492	4014486493955
	070461T1	1	1002494	4014486493986
	072727T1	1	1002560	4014486495102
	1036940M1	1	1000876	4014486473162
	105654W1	1	1002005	4014486491326
	112366410100	1	1003992	4014486518689
	117029010800	1	1000118	4014486461275
	1175-105-150.00	1	1001544	4014486460643
	117510515000	1	1001544	4014486460643
	1447317M1	1	1003729	4014486495195
	1447784M91	2	1002545	4014486494754
	1482511M2	1	1002558	4014486495034
	1483880M1	1	1000540	4014486468229
	1483881M1	1	1000609	4014486469486
	1483882M1	1	1003489	4014486468427
	1604464M1	1	1002056	4014486475333
	1614629M91	2	1002743	4014486483963
	1615962M1	1	1000759	4014486471601
	1616714M1	1	1001485	4014486459951
	1616715M1	1	1001460	4014486459685
	1617332M1	1	1000089	4014486460865
	1621182M1	1	1002265	4014486478327
	1628951M1	1	1003551	4014486471953
	1630361M1	1	1000021	4014486483413
	1641945M1	1	1000189	4014486462197
	1669923M1	1	1000066	4014486483864
	1671988M1	1	1001179	4014486458954
	1695146M1	1	1002573	4014486495430
	1700120M1	1	1000034	4014486460711
	1715558M91	1	1000183	4014486462128



## AGCO

	1718508M91	2	1002750	4014486461602
	1730033M91	1	1000077	4014486483987
	1730034M91	1	1000075	4014486483956
	1730366M1	1	1000872	4014486473124
	1730687M1	1	1003552	4014486471991
	1730781M1	1	1003554	4014486472394
	1730782M1	1	1000771	4014486471786
	1730976M1	1	1000842	4014486472714
	1731015M1	1	1000707	4014486470949
	1731023M1	1	1000722	4014486471144
	1810378M91	2	1000534	4014486468144
	1810382M91	2	1002780	4014486462432
	1810543M91	2	1002781	4014486462470
	186976M1	1	1002551	4014486494846
	1876670M1	1	1000061	4014486483819
	195672M1	1	1000633	4014486469868
	197-6290	1	1004389	4014486716160
	197-6291	1	1004388	4014486716153
	197-6292	1	1004387	4014486716146
	200432M1	1	1000636	4014486469929
	207-2949	1	1004872	4014486716399
	218560M91	1	1003599	4014486485110
	226981M1	1	1001473	4014486459838
	230356M4	1	No AP	
	233213M1	1	No AP	
	238887M2	1	No AP	
	240447M3	1	No AP	
	2833904M3	1	1004744	4014486720310
	3019084M91	2	1002949	4014486495454
	3021192M1	1	1000145	4014486461633
	3021313M3	1	1000128	4014486461428
	3035568M2	1	1001058	4014486484458
	3035569M1	1	1001055	4014486484427
	3036278M1	1	1002050	4014486475265
	3041017M1	1	1002520	4014486494358
	3042011M1	1	1002310	4014486479980
	3042012M1	1	1002302	4014486479904
	3049776M1	1	1000563	4014486468656
	3050742M1	1	1000651	4014486470116
	3052209M1	1	1002582	4014486495638
	3098211M2	1	1004188	4014486554366
	3098212M2	1	1003595	4014486518351
	3106033M1	1	1002061	4014486475418
	31-1730870	1	1001119	4014486497052
	3145135M91	2	1002956	4014486495720
	3148053M91	2	1002961	4014486495058
	3173304M1	1	1000822	4014486472486
	3175109M1	1	1000771	4014486471786
	3175160M1	1	1000844	4014486472738
	3193693M2	1	1002265	4014486478327
	3226971M2	1	1001510	4014486460278
	3315897M1	1	1000194	4014486462289
	3316647M1	1	1000709	4014486470970
	3371438M1	1	1000590	4014486520255
	3371692M1	1	1000344	4014486465952



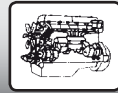

## AGCO

	3371800M2	1	1001465	4014486459753
	3372217M1	1	1002049	4014486475258
	3383045M1	1	1002484	4014486493825
	3383691F1	1	1002526	4014486494440
	3386191M1	1	1002952	4014486495539
	3389542M91	2	1002954	4014486495829
	3435748M1	1	1002536	4014486494594
	3465729M1	1	1000404	4014486466676
	3538921M1	1	1000120	4014486461312
	3581286M1	1	1002588	4014486495812
	3581635M1	1	1002529	4014486494488
	3582951M1	1	1002537	4014486494600
	3582954M1	1	1002587	4014486495799
	3587700M1	1	1004720	4014486716696
	3587701M91	2	1004719	4014486716702
	3590943M1	1	1000220	4014486462838
	3590944M1	1	1003398	4014486462883
	3616513M1	1	1002585	4014486495744
	3617176M91	2	1002958	4014486495782
	3617178M91	2	1002916	4014486493092
	3617183M1	1	1002589	4014486495836
	3619085M1	1	1002574	4014486495447
	3619357M1	1	1002921	4014486493863
	3619358M91	2	1002944	4014486495294
	3637597M1	1	1002548	4014486494808
	3637598M91	2	1002946	4014486494938
	3637978M91	1	1002550	4014486494822
	3648900M1	1	1002339	4014486478723
	3656765M1	1	1002354	4014486478877
	3700656M1	1	1002329	4014486478587
	3700658M91	2	1002463	4014486493481
	3712532M1	1	1002532	4014486494525
	3761507M91	2	1002923	4014486493511
	3777379M91	2	1002958	4014486495782
	3777682M1	2	1002962	4014486495027
	3777748M1	2	1002517	4014486494327
	3778975M2	1	1002516	4014486494310
	3780139M1	1	1002566	4014486495249
	3780140M1	1	1002568	4014486495317
	3780141M1	1	1002571	4014486495379
	3780602M1	1	1002580	4014486495591
	3780609M1	1	1002555	4014486494945
	3780610M1	1	1002556	4014486494983
	3780611M1	1	1002556	4014486494983
	3780612M1	1	1002568	4014486495317
	3780613M1	1	1002565	4014486495225
	3780614M1	1	1002576	4014486495508
	3780617M1	1	1002559	4014486495072
	3780645M91	2	1002963	4014486495324
	3780908M91	2	1002969	4014486495584
	3920203M	1	1002340	4014486478730
	3920419M	1	1001275	4014486474411
	3920562M	1	1001276	4014486474428
	3920712M	1	1002289	4014486479720
	406562M1	1	1000869	4014486473087



## AGCO

	406681M1	1	1000836	4014486472639
	407189M91	1	1002071	4014486475579
	407218M1	1	1003690	4014486478068
	407692M1	1	1003451	4014486465594
	410215M1	1	No AP	
	410617M1	1	No AP	
	410919M1	1	1000661	4014486470253
	410957M1	1	1003493	4014486468489
	410958M1	1	1000552	4014486468403
	411218M1	1	1001065	4014486496499
	41990007X	2	1004764	4014486719277
	4275185M91	1	1002524	4014486494426
	4288688M1	1	1004687	4014486716085
	4293007M2	1	1004350	4014486716139
	489734M2	1	1002560	4014486495102
	500251D1	1	1002668	4014486482027
	500252D1	1	1003945	4014486481969
	511277M3	1	1000111	4014486461169
	5115483M1	1	1002529	4014486494488
	514806M1	1	1000094	4014486460926
	518125M2	1	1000099	4014486460995
	523733M1	1	1000095	4014486460933
	523735M1	1	1000146	4014486461640
	530669M1	1	1000096	4014486460940
	530756M1	1	1000147	4014486461657
	531316M1	1	1002089	4014486475814
	583824M1	1	1001354	4014486474688
	584850M1	1	1000223	4014486462890
	600P02	1	1004032	4014486518443
	604735M1	1	1000556	4014486468502
	604964M1	1	1003398	4014486462883
	605638M91	2	1002780	4014486462432
	6200242M1	1	1000590	4014486520255
	6200432M1	1	1001484	4014486459944
	6201516M1	1	1001770	4014486487558
	6201932M1	1	1002568	4014486495317
	6202555M1	1	1001815	4014486488302
	6202933M1	1	1002016	4014486491494
	6203462M2	1	1003923	4014486486254
	6203660M1	1	1000587	4014486469080
	6203678M1	1	1000717	4014486471076
	6203764M1	1	1001611	4014486485394
	6209374M1	1	1001638	4014486485882
	6209375M1	1	1000350	4014486466065
	6210650M1	1	1003495	4014486468588
	6210826M1	1	1001632	4014486485776
	6210914M1	1	1001719	4014486487015
	6211072M1	1	1001773	4014486487596
	6211078M1	1	1000329	4014486465624
	6211079M1	1	1001189	4014486519846
	6211081M1	1	1001600	4014486485226
	6211082M1	1	1001971	4014486490848
	6211083M1	1	1001139	4014486490015
	6211250M1	1	1000726	4014486471182
	6211508M1	1	1003924	4014486487718



## AGCO

	6212014M1	1	1003925	4014486487657
	6212790M1	1	1000693	4014486470741
	621320M2	1	1001486	4014486459968
	621321M2	1	1001482	4014486459920
	6213293M2	1	1004492	4014486721249
	621646M1	1	1001471	4014486459814
	621646M1	1	1001471	4014486459814
	6216726M1	1	1003836	4014486471236
	6216981M1	1	1002548	4014486494808
	6217825M1	1	No AP	
	6217950M1	1	1002496	4014486494013
	6217977M1	1	1000676	4014486470482
	6218984M1	1	1002004	4014486491319
	6219167M1	1	1001778	4014486487640
	6219396M1	1	1001545	4014486460650
	6219408M1	1	1004627	4014486720563
	6219414M1	1	1003663	4014486490817
	6219415M1	1	1004592	4014486717846
	6220518M1	1	1004562	4014486721300
	6220817M1	1	1004491	4014486721232
	6220987M1	1	1003503	4014486469103
	6223463M1	1	No AP	
	6227303M1	1	1004559	4014486721287
	6228951M1	1	No AP	
	6228952M1	1	No AP	
	6230012M1	1	1001544	4014486460643
	6230019M1	1	1004734	4014486719048
	6230739M1	1	1000685	4014486470635
	6230741M1	1	1001616	4014486485462
	6230869M1	1	1004733	4014486719031
	6230964M1	1	1000345	4014486465969
	623098M1	1	1000187	4014486462166
	6231546M1	1	1004199	4014486675498
	6231547M1	1	1001741	4014486487251
	6231843M1	1	1000650	4014486470123
	6232489M1	1	1001613	4014486485431
	6232589M1	1	1004621	4014486717518
	623537M1	1	1000032	4014486460698
	6235815M1	1	1003926	4014486487817
	6235825M1	1	1003927	4014486487831
	6236823M1	1	1002526	4014486494440
	6236843M1	1	No AP	
	6237294M1	1	1004561	4014486721317
	6237300M1	1	1004297	4014486683288
	6237301M1	1	1004281	4014486683127
	6239971M1	1	1000560	4014486468595
	6240108M1	1	No AP	
	624728M1	1	1000031	4014486460681
	6248647M1	1	1004493	4014486721256
	6262408M1	1	No AP	
	6263504M1	1	1003334	4014486462586
	6266289M1	1	1004489	4014486721218
	6268248M1	1	No AP	
	6268436M1	1	1001672	4014486486360
	6268461M1	1	No AP	

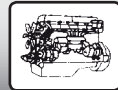

## AGCO

	6268461M1	1	No AP	
	6268461M1	1	No AP	
	6268461M1	1	No AP	
	6268461M1	1	No AP	
	6268461M1	1	No AP	
	6268912M1	1	1004490	4014486721225
	6272560M1	1	1004859	4014486720570
	6272565M1	1	No AP	
	6273869M1	1	1003835	4014486463835
	6275380M1	1	1004740	4014486718973
	6275381M1	1	1004741	4014486718980
	6284282M1	1	1003508	4014486469240
	6289542M1	1	1004586	4014486717785
	6289543M1	1	1003878	4014486485585
	6289544M1	1	1001651	4014486486032
	6289545M1	1	1004519	4014486718294
	629004M1	1	1000488	4014486467598
	6290138M1	1	1000100	4014486461008
	6290856M1	1	1001638	4014486485882
	6294242M1	1	1001679	4014486486483
	6298212M1	1	No AP	
	6298761M1	1	1001632	4014486485776
	6298767M1	1	1004847	4014486717167
	6303174M1	1	1001654	4014486486070
	6303185M1	1	1001830	4014486488531
	636208M1	1	1000490	4014486467628
	636276M1	1	1000491	4014486467635
	641696M1	1	1000192	4014486462234
	650.203.040.010	2	1004801	4014486720464
	650.623.030.550	1	1004651	4014486718652
	650203010870	1	1003144	4014486481013
	650203040010	2	1004801	4014486720464
	650623030550	1	1004651	4014486718652
	650633020010	1	1004678	4014486719734
	6627918	1	1004792	4014486719499
	669452M91	2	1002783	4014486462371
	685121905	1	1004687	4014486716085
	71390199	1	1001604	4014486485295
	71396754	1	1004364	4014486714074
	71426450	1	1004501	4014486717051
	71432802	1	1001664	4014486486247
	71444306	1	1001657	4014486486117
	71444986	1	1003718	4014486519365
	782835M1	1	1001470	4014486459807
	783539M1	1	1001481	4014486459913
	783907M2	1	1000235	4014486463361
	784789M2	1	1000643	4014486470031
	787237M1	1	1003520	4014486469806
	832882M1	1	1000323	4014486465471
	833857M3	1	1001476	4014486459869
	833857M5	1	1001476	4014486459869
	833858M5	1	No AP	
	833865M2	1	1003665	4014486490879
	833874M2	1	1001848	4014486488791
	834061M1	1	1002423	4014486493009

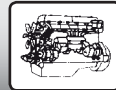

## AGCO

	834110M1	1	1001480	4014486459906
	834174M1	1	1001462	4014486459722
	842413M2	1	1000227	4014486463040
	843810M1	1	1001184	4014486490220
	84416 M1	1	1000121	4014486461329
	87041732C	1	1004060	4014486518771
	901855M1	1	1000574	4014486468823
	906424M1	1	1000071	4014486483918
	916201040200	1	1004340	4014486719611
	916799M1	1	1000585	4014486469066
	916800M2	1	1000775	4014486471847
	916854M1	1	1000385	4014486466485
	960972M1	1	1002051	4014486475289
	962666M1	1	1002467	4014486493535
	969186M1	1	1002047	4014486475234
	AG516558	1	1000984	4014486498042
	AG516559	1	No AP	
	AG516861	1	1000983	4014486498035
	AG517279	1	1000985	4014486498059
	D41910400	1	1000141	4014486461589
	D41921801	1	1004180	4014486523027
	D41944700	1	1004840	4014486715446
	D41978600	1	1001365	4014486474794
	D41981400	1	1001437	4014486459456
	D41985900	1	1000648	4014486470093
	D41990014	1	1002335	4014486478679
	D41997900	1	No AP	
	E040T07	1	1004021	4014486519716
	F524200040160	1	1002694	4014486483123
	F716200040020	1	1003163	4014486481358
	F718202040010	1	1003813	4014486481501
	GR17880810	1	1001025	4014486497984
	LA340433238	1	1000210	4014486462562
	LA340433242	1	1000213	4014486462685
	LA344311322	1	1002015	4014486491487
	V33099800	1	1004824	4014486719314
	V33279300	1	1002558	4014486495034
	V33279600	1	1002537	4014486494600
	V35354900	1	1004607	4014486719338
	V35380300	1	1002345	4014486478785
	V684101000	1	1002453	4014486493351
	V684101025	1	1002455	4014486493375
	V684101050	1	1002456	4014486493399
	V684101100	1	1002459	4014486493429
	V684101125	1	1002460	4014486493436
	V684101150	1	1002462	4014486493467
	V684101175	1	1002465	4014486493504
	V684101225	1	1002471	4014486493573
	V684101238	1	1004876	4014486719840
	V684101350	1	1002483	4014486493801
	V684120825	1	1002507	4014486494129
	V684120875	1	1002512	4014486494204
	V684120900	1	1002514	4014486494266
	V684120918	1	1002415	4014486494280
	V684120925	1	1002515	4014486494297

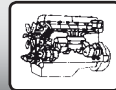

## AGCO

	V684120950	1	1004851	4014486716542
	V684120975	1	1002520	4014486494358
	V684120992	1	1004773	4014486716559
	V684121050	1	1002529	4014486494488
	V684121075	1	1002532	4014486494525
	V684121100	1	1002534	4014486494556
	V684121125	1	1002537	4014486494600
	V684121200	1	1002547	4014486494778
	V684121225	1	1002549	4014486494815
	V684121250	1	1002549	4014486494815
	V684121250	1	1002551	4014486494846
	V684121275	1	1002554	4014486494914
	V684121550	1	1002586	4014486495775
	V684121575	1	1002588	4014486495812
	V684121600	1	1002589	4014486495836
	V684121625	1	1002593	4014486495904
	V684121650	1	1003746	4014486495928
	V684121675	1	1002594	4014486495942
	V685061555	1	1004861	4014486719550
	V685061675	1	1004863	4014486719574
	V685061725	1	1004864	4014486719581
	V685061740	1	1004865	4014486719598
	V685061755	1	No AP	
	V685061755	1	No AP	
	V685081290	1	1004869	4014486716351
	V685081315	1	1004870	4014486716368
	V685081660	1	1003158	4014486481204
	V685081680	1	1003160	4014486481242
	V685081710	1	1003162	4014486481341
	V685081745	1	1002658	4014486481433
	V685081785	1	No AP	
	V685081800	1	1003813	4014486481501
	V685081850	1	1003177	4014486481587
	V685081895	1	1003183	4014486481662
	V685081920	1	1002662	4014486481747
	V685082300	1	1003217	4014486482454
	V685102194	1	1004317	4014486715965
	V685121370	1	1004339	4014486716009
	V685121530	1	1003067	4014486484083
	V685121555	1	1004341	4014486716023
	V685121570	1	1004342	4014486716030
	V685121610	1	1004343	4014486716047
	V685121725	1	1003074	4014486484151
	V685121765	1	1004344	4014486716054
	V685121845	1	1004345	4014486716061
	V685121860	1	1004829	4014486716078
	V685121880	1	1004829	4014486716078
	V685121905	1	1004687	4014486716085
	V685121945	1	1004346	4014486716092
	V685121965	1	1004347	4014486716108
	V685122020	1	1004348	4014486716115
	V685122140	1	1003954	4014486484267
	V685141585	1	1004390	4014486716177
	V836007765	1	1000201	4014486462395
	WR10487	1	1001350	4014486474633

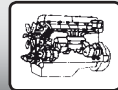

## AGCO

	X696.519.400.000	1	1000089	4014486460865
	X696.610.600.000	1	1000004	4014486483192
	X696.611.312.000	1	1000010	4014486483277
	X696.611.611.000	1	1002440	4014486493184
	X696.612.000.000	2	1002919	4014486493832
	X696.612.200.000	2	1002477	4014486493672
	X696.612.313.000	2	1002741	4014486483239
	X696.612.400.000	2	1002925	4014486493795
	X696.612.500.000	1	1000007	4014486483246
	X696.612.600.000	2	1002926	4014486493733
	X696.612.602.000	1	1002479	4014486493726
	X696.612.811.000	1	1002444	4014486493221
	X696.612.913.000	1	1002445	4014486493245
	X696.613.101.000	1	1002447	4014486493269
	X696.613.308.000	1	1000011	4014486483284
	X696.613.501.000	2	1002930	4014486493603
	X696.613.600.000	1	1000012	4014486483291
	X696.613.801.000	1	1002450	4014486493306
	X696.613.901.000	2	1002469	4014486493559
	X696.614.513.000	1	1002455	4014486493375
	X696.614.601.000	1	1002456	4014486493399
	X696.614.700.000	1	1003363	4014486483383
	X696.614.802.000	2	1002421	4014486492989
	X696.614.913.000	1	1002462	4014486493467
	X696.615.002.000	2	1002923	4014486493511
	X696.615.200.000	1	1002468	4014486493542
	X696.615.301.000	2	1002931	4014486493818
	X696.615.401.000	1	1002471	4014486493573
	X696.615.408.000	1	1000024	4014486483451
	X696.615.600.000	1	1000026	4014486483475
	X696.615.601.000	2	1002924	4014486493658
	X696.615.704.000	2	1002932	4014486493917
	X696.616.000.000	2	1002472	4014486493580
	X696.616.102.000	1	1002441	4014486493191
	X696.616.201.000	2	1002481	4014486493764
	X696.616.300.000	1	1002443	4014486493214
	X696.616.600.000	2	1002489	4014486493924
	X696.616.702.000	2	1002934	4014486493962
	X696.616.702.010	1	1002492	4014486493955
	X696.616.800.000	2	1002485	4014486493856
	X696.616.913.000	1	1002474	4014486493610
	X696.617.701.000	2	1002429	4014486493061
	X696.617.800.000	1	1002451	4014486493313
	X696.617.900.000	1	1002473	4014486493597
	X696.618.200.000	1	1000046	4014486483659
	X696.619.200.000	1	1002534	4014486494556
	X696.619.413.000	1	1000060	4014486483802
	X696.622.000.000	1	1000086	4014486460834
	X696.622.700.000	1	1002504	4014486494082
	X696.622.800.000	1	1002503	4014486494075
	X696.622.900.000	1	1002505	4014486494105
	X696.623.000.000	1	1002511	4014486494181
	X696.623.200.000	1	1002514	4014486494266
	X696.623.300.000	1	1002415	4014486494280
	X696.623.400.000	1	1002520	4014486494358



## AGCO

	X696.623.600.000	1	1002529	4014486494488
	X696.623.700.000	1	1002537	4014486494600
	X696.623.800.000	1	1002539	4014486494648
	X696.623.900.000	1	1002543	4014486494723
	X696.624.100.000	1	1002528	4014486494471
	X696.624.200.000	1	1002547	4014486494778
	X696.624.300.000	1	1002541	4014486494693
	X696.624.400.000	1	1002549	4014486494815
	X696.624.500.000	1	1002552	4014486494877
	X696.624.800.000	1	1002561	4014486495119
	X696.629.509.000	2	1000991	4014486484311
	X696.631.009.000	1	1000993	4014486484335
	X696.631.409.000	2	1000994	4014486484342
	X696.631.609.000	2	1000995	4014486484359
	X696.633.500.000	1	1000996	4014486484366
	X696.633.800.000	1	1000209	4014486462555
	X696.635.400.000	1	1000997	4014486484373
	X696.635.500.000	1	1003397	4014486462821
	X696.640.500.000	1	1002501	4014486497939
	X696.640.600.000	1	1002502	4014486497946
	X696.642.000.000	1	1003731	4014486495263
	X696.989.501.000	1	1001131	4014486496444
	X696519400000	1	1000089	4014486460865
	X696610600000	1	1000004	4014486483192
	X696611611000	1	1002440	4014486493184
	X696612000000	2	1002919	4014486493832
	X696612313000	2	1002741	4014486483239
	X696612400000	2	1002925	4014486493795
	X696612500000	1	1000007	4014486483246
	X696612600000	2	1002926	4014486493733
	X696612602000	1	1002479	4014486493726
	X696612811000	1	1002444	4014486493221
	X696613101000	1	1002447	4014486493269
	X696613308000	1	1000011	4014486483284
	X696613501000	2	1002930	4014486493603
	X696613600000	1	1000012	4014486483291
	X696613801000	1	1002450	4014486493306
	X696613901000	2	1002469	4014486493559
	X696614513000	1	1002455	4014486493375
	X696614601000	1	1002456	4014486493399
	X696614700000	1	1003363	4014486483383
	X696614802000	2	1002421	4014486492989
	X696615002000	2	1002923	4014486493511
	X696615200000	1	1002468	4014486493542
	X696615301000	2	1002931	4014486493818
	X696615401000	1	1002471	4014486493573
	X696615408000	1	1000024	4014486483451
	X696615600000	1	1000026	4014486483475
	X696615601000	2	1002924	4014486493658
	X696615704000	2	1002932	4014486493917
	X696616000000	2	1002472	4014486493580
	X696616102000	1	1002441	4014486493191
	X696616201000	2	1002481	4014486493764
	X696616300000	1	1002443	4014486493214
	X696616600000	2	1002489	4014486493924





## AGCO

		X696616702000	2	1002934	4014486493962
		X696616800000	2	1002485	4014486493856
		X696617800000	1	1002451	4014486493313
		X696617900000	1	1002473	4014486493597
		X696618200000	1	1000046	4014486483659
		X696619200000	1	1002534	4014486494556
		X696619413000	1	1000060	4014486483802
		X696622000000	1	1000086	4014486460834
		X696622700000	1	1002504	4014486494082
		X696622800000	1	1002503	4014486494075
		X696622900000	1	1002505	4014486494105
		X696623000000	1	1002511	4014486494181
		X696623200000	1	1002514	4014486494266
		X696623300000	1	1002415	4014486494280
		X696623400000	1	1002520	4014486494358
		X696623600000	1	1002529	4014486494488
		X696623700000	1	1002537	4014486494600
		X696623800000	1	1002539	4014486494648
		X696623900000	1	1002543	4014486494723
		X696624100000	1	1002528	4014486494471
		X696624200000	1	1002547	4014486494778
		X696624300000	1	1002541	4014486494693
		X696624400000	1	1002549	4014486494815
		X696624500000	1	1002552	4014486494877
		X696624800000	1	1002561	4014486495119
		X696629509000	2	1000991	4014486484311
		X696631009000	1	1000993	4014486484335
		X696631409000	2	1000994	4014486484342
		X696631609000	2	1000995	4014486484359
		X696633500000	1	1000996	4014486484366
		X696633800000	1	1000209	4014486462555
		X696635400000	1	1000997	4014486484373
		X696635500000	1	1003397	4014486462821
		X696640500000	1	1002501	4014486497939
		X696640600000	1	1002502	4014486497946
		X697.170.100.000	1	1001040	4014486498103
		X697.171.900.000	1	1001048	4014486498189
		X697.171.901.000	1	1001047	4014486498172
		X697.172.100.000	1	1001049	4014486498196
		X697.173.600.000	1	1002631	4014486480238
		X697.174.000.000	1	1004337	4014486715996
		X697170100000	1	1001040	4014486498103
		X697171900000	1	1001048	4014486498189
		X697171901000	1	1001047	4014486498172
		X697172100000	1	1001049	4014486498196
		X697173600000	1	1002631	4014486480238
		XP12472	1	1000763	4014486471649
<b>L 517</b>					
5	STRAW ELEVATOR DRIVE	340433474	1	1000789	4014486472059
5	STRAW ELEVATOR DRIVE	LA340433474	1	1000789	4014486472059
<b>L 521</b>					
5	STRAW ELEVATOR DRIVE	340433474	1	1000789	4014486472059
5	STRAW ELEVATOR DRIVE	LA340433474	1	1000789	4014486472059



## AGCO

L 524					
5	STRAW WALKER DRIVE	340433474	1	1000789	4014486472059
5	STRAW WALKER DRIVE	LA340433474	1	1000789	4014486472059
L 624					
5	STRAW ELEVATOR DRIVE	340433474	1	1000789	4014486472059
5	STRAW ELEVATOR DRIVE	LA340433474	1	1000789	4014486472059
L 626					
5	STRAW ELEVATOR DRIVE	340433474	1	1000789	4014486472059
5	STRAW ELEVATOR DRIVE	LA340433474	1	1000789	4014486472059
M 1600					
1	STRAW STRIPPER DRUM	6215259	1	1002016	4014486491494
M 1620					
1	STRAW STRIPPER DRUM	6215259	1	1002016	4014486491494
M 1630					
1	STRAW STRIPPER DRUM	6215259	1	1002016	4014486491494
MEGA 204 II					
18	AT 3.9M - 5.1M	26746968	3	1004837	4014486714906
MEGA 208					
18	AT 4.5M - 5.1M	01145049	3	1004837	4014486714906
MEGA 208 II					
18	AT 4.5M - 5.1M	01145049	1	1000317	4014486465341
MEGA 218					
30	RADIATOR SCREEN	038357T1	1	1000161	4014486461831



## BISO

	460189	1	1004083	4014486476972
	41981500	1	1004070	4014486520132
	84021591	2	1004053	4014486484038
	84058338	1	1004054	4014486519938
	84449765	1	1004043	4014486518924
	87311867	1	1004046	4014486518382
	87317063	1	1004047	4014486519068
	87330894	1	1004048	4014486519372
	87629601	1	1004050	4014486519785
	87629602	1	1004051	4014486519761
	0554099.1	1	1004073	4014486520361
	10VX00	1	1000801	4014486472202
	10VX00A	1	1004024	4014486519082
	10VX00B	1	1004023	4014486519075
	18 PJ 1244	1	1004104	4014486521009
	600A02B	1	1003990	4014486518672
	600A03	1	1000766	4014486471694
	600A07	1	1000769	4014486471748
	600A09	1	1000602	4014486469349
	600A14	1	1000575	4014486468847
	600A17	1	1000615	4014486469530
	600A750	1	1000808	4014486472318
	600J02	1	1003984	4014486518603
	600J03	1	1003985	4014486518610
	600J07	1	1000674	4014486470468
	600J20	1	1000756	4014486471571
	600J22	1	1000725	4014486471175
	600J31	1	1003986	4014486518627
	600P01	1	1003392	4014486462678
	600P03	1	1003384	4014486462272
	600P04	1	1004033	4014486518450
	600P06	1	1000196	4014486462333
	600P12	1	1003385	4014486462302
	600P90	1	1004034	4014486518467
	9351.0013.00	1	1000628	4014486469783
	9351.0046.00	1	1000730	4014486471229
	9351.0053.00	1	1000738	4014486471335
	9351.0077.00	1	1000792	4014486472110
	9351.0082.00	1	1000798	4014486472172
	9351.0084.00	1	1003987	4014486518962
	9351.0092.00	1	1003988	4014486518979
	9351.0108.00	1	1000836	4014486472639
	9351.0128.00	1	1003688	4014486477979
	9351.0132.00	1	1003312	4014486477993
	9351.0136.00	1	1003690	4014486478068
	9351.0148.00	1	1004029	4014486519198
	9351.0150.00	1	1002247	4014486478143
	9351.0154.00	1	1002251	4014486478181
	9351.0183.00	1	1003326	4014486486087
	9351.0190.00	1	1001690	4014486486643
	9351.0193.00	1	1001692	4014486486674
	9351.0196.00	1	1004012	4014486519440
	9351.0234.00	1	1000278	4014486464528
	9351.0286.00	1	1001702	4014486486797
	9351.0287.00	1	1003346	4014486486124



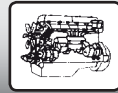
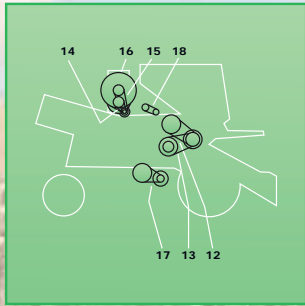
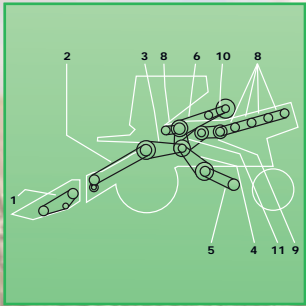

# BIZON

## TC 59

1		84021588	1	1000083	4014486519358
5		84026042	1	1001621	4014486485530
6		84996133	1	1001657	4014486486117
7		9818873	1	1003662	4014486490718
7		89818873	1	1003662	4014486490718
8		825117	1	1004147	4014486523287
9		9515076	1	1001416	4014486459234
9		89515076	1	1001416	4014486459234
10		9515075	1	1001428	4014486459364
10		89515075	1	1001428	4014486459364

## Z 110 BS

1	KNIFE DRIVE	51101131525	1	1000123	4014486461350
3	PITCHED CONVEYOR	51103173220	1	1003638	4014486488982
4	INTERMEDIATE SOWING DRIVE SHAFT	51103173062	1	1003637	4014486488883
5	BOTTOM EAR SCREW	51101172438	2	1004834	4014486714852
6	INTERMEDIATE ATTACHMENT	51104173940	1	1003666	4014486491234
7	INTERMEDIATE SHAFT	51104172270	1	1001952	4014486490572
8	DRUM SHAKER	51103172120	1	1001811	4014486488234
13	DRUM DRIVE	51101622375	1	1001545	4014486460650
15	MOTOR FAN	51101171750	1	1003418	4014486463705
16	ROTATIONAL GUARD	51101132800	1	1000158	4014486461800
17	FAN VARI-DRIVE	51101321750	1	1001413	4014486459203
		51101131570	1	1000126	4014486461381
		51101171335	1	1000218	4014486462807
		51101171375	1	1000221	4014486462852
		51101171981	1	1000267	4014486464269
		51101222525	1	1000628	4014486469783
		51101255970	1	1000930	4014486473803
		51102173550	1	1001651	4014486486032
		51103172380	1	1001827	4014486488487
		51103172650	1	1001840	4014486488661
		51651222360	1	1000615	4014486469530
		1374-310-409	1	1001840	4014486488661

AG - BI  
CA - CL  
DE - DR  
FE - FO  
GO - GR  
IN - JO  
KP - KZ  
LA - ME  
NE - RO  
SA - ST  
VA - ZM  
PARTS  
SERVICE

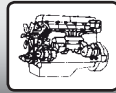
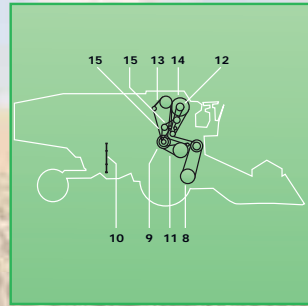
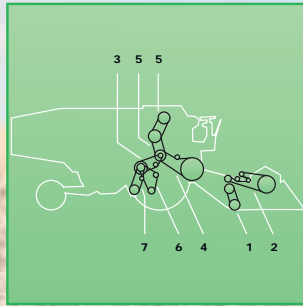
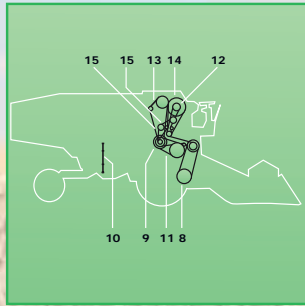
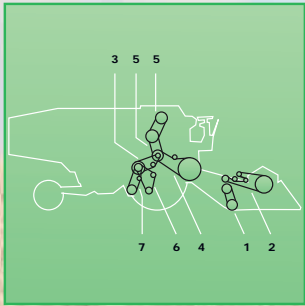

## CASE INTL. HARVESTER

30

3	AUGER DRIVE (SIDE)	452864R1	1	No AP	
---	--------------------	----------	---	-------	--

80

7	MAIN DRIVE FARMALL 400 450 460 560 (RIGHT HAND)	191305C1	1	1000654	4014486470178
---	---	----------	---	---------	---------------

85

6	MAIN DRIVE FARMALL 400 450 460 560 (RIGHT HAND)	191305C1	1	1000654	4014486470178
---	---	----------	---	---------	---------------

95

1	ALTERNATOR, FAN AND WATERPUMP DRIVE	59969C91	2	1003957	4014486495867
---	-------------------------------------	----------	---	---------	---------------

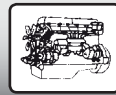
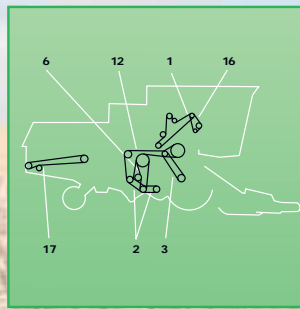
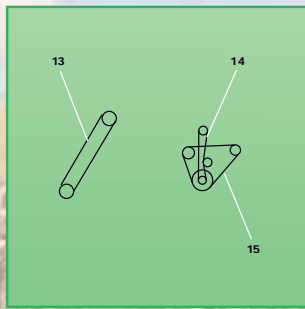
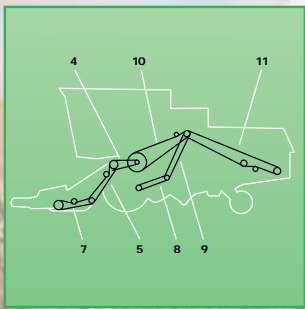

## CASE INTL. HARVESTER

### 715

7	AUGER AND KNIFE DRIVE (102)	178019C1	1	1000625	4014486469738
7	AUGER AND KNIFE DRIVE (112)	191305C1	1	1000654	4014486470178
17	STRAW SPREADER DRIVE	589622R1	1	1000421	4014486466843

### 730

1	REEL DRIVE VARIABLE SPEED	Z20459	1	1003583	4014486459029
2	REEL DRIVE	Z20562	1	1000753	4014486471526
3	HYDRAULIC PUMP DRIVE	Z21254	1	1003372	4014486461244
4	UNLOADING SYSTEM	Z21400	1	1003496	4014486468649
5	SICKLE KNIFE DRIVE	Z21500	1	1001103	4014486496857
5	SICKLE KNIFE DRIVE	Z21501	1	1001102	4014486496840
6	STRAW ELEVATOR DRIVE	Z21501	1	1001102	4014486496840
7	THRESHING DRUM VARIATOR DRIVE	Z22648	1	No AP	
8	TRACTION DRIVE	P40058	1	1001493	4014486460032
9	FAN DRIVE VARIABLE SPEED	Z20459	1	1003583	4014486459029
10	FAN DRIVE	Z20703	1	1000679	4014486470529
11	ROTARY SCREEN - ELEVATOR	Z20743	1	1003505	4014486469196
13	HYDRAULIC PUMP DRIVE - ENGINE	Z22208	1	1003720	4014486494891

### 782

2	FAN DRIVE	214522C1	1	1004125	4014486523072
5	AIR CONDITIONING COMPRESSOR DRIVE	280210C2	1	1000115	4014486461237

### 810

3	KNIFE DRIVE - 500 CPM 103-25/32-INCH OC	178019C1	1	1000625	4014486469738
---	---	----------	---	---------	---------------

### 815

5	KNIFE DRIVE	178019C1	1	1000625	4014486469738
---	-------------	----------	---	---------	---------------

### 820

1	DRIVE 112-13/64-INCH	191305C1	1	1000654	4014486470178
---	----------------------	----------	---	---------	---------------

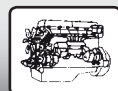
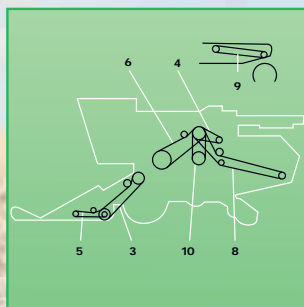
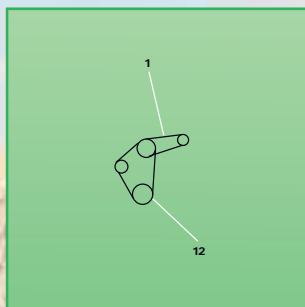
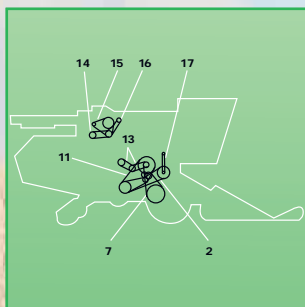

## CASE INTL. HARVESTER

<b>915</b>					
5	KNIFE DRIVE	178019C1	1	1000625	4014486469738
9	STRAW SPREADER DRIVE	196371C1	1	1000423	4014486466867
<b>923</b>					
5	UNLOADING JACKSHAFT DRIVE	3175336R1	1	1000684	4014486470628
6	CYLINDER	3175110R1	1	1001504	4014486460193
12	FAN - RETURN	3176321R1	1	1001367	4014486474817
<b>933</b>					
5	UNLOADING JACKSHAFT DRIVE	3157994R1	1	1003542	4014486470895
6	CYLINDER	3175110R1	1	1001504	4014486460193
8	FEEDER - PLATFORM	3157741R1	1	1001098	4014486496802
9	TRACTION (UPPER)	3157094R1	1	1001117	4014486497021
12	FAN - RETURN	3176321R1	1	1001367	4014486474817
13	FEEDER - JACKSHAFT	3173480R1	1	1000913	4014486473629
<b>943</b>					
1	INTERMEDIATE SHAFT	790522R1	1	1000578	4014486468939
6	SEPARATOR DRIVE	1407123R1	1	1001418	4014486459258
10	CUTTING TABLE DRIVE	3173115R1	1	1000914	4014486473636
11	FEEDER - PLATFORM	3167149R1	1	1001760	4014486487435
12	TRACTION DRIVE	3173717R1	1	1000725	4014486471175
15	FEEDER - JACKSHAFT	3173164R1	2	1002883	4014486471359
18	REEL DRIVE VARIABLE SPEED	1407123R1	1	1001418	4014486459258



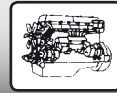
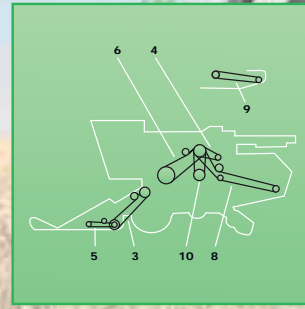
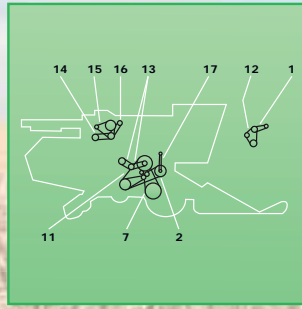
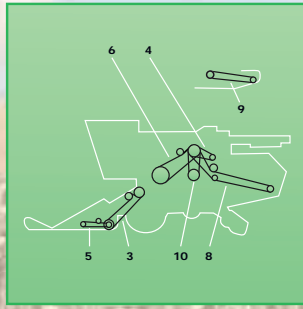
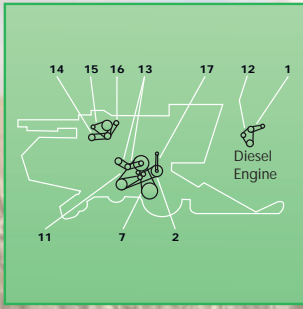

## CASE INTL. HARVESTER

### 953

1	REEL VARIATOR	1407123R1	1	1001418	4014486459258
2	CUTTING TABLE DRIVE	3167797R1	2	1002882	4014486471564
3	CUTTING TABLE DRIVE	3167149R1	1	1001760	4014486487435
4	MAIN DRIVE	3167653R2	1	1001999	4014486491258
5	DISCHARGE AUGER SHAFT	3167361R2	1	1000637	4014486469943
8	RETURN AUGER - SHAKER	3167489R1	1	1004101	4014486469165
11	RETURN ELEVATOR DRIVE	3170210R1	1	1000686	4014486470642
13	INTERMEDIATE SHAFT	790522R1	1	1000578	4014486468939
16	FAN	1407123R1	1	1001418	4014486459258

### 1400

33	AIR CONDITIONING COMPRESSOR DRIVE	280210C2	1	1000115	4014486461237
	STRAW CHOPPER DRIVE	181012C1	1	1001595	4014486675481
	CLEANING UNIT DRIVE WITH STRAW CHOPPER	181055C1	1	1001374	4014486474886
	STRAW SPREADER DRIVE	196371C1	1	1000423	4014486466867
	REEL DRIVE PUMP WITHOUT ROCK TRAP	197411C1	1	1000702	4014486470857

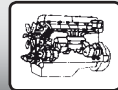
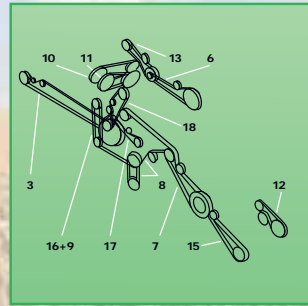
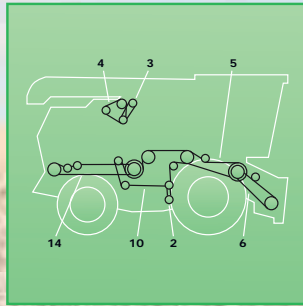
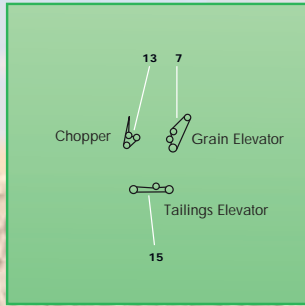
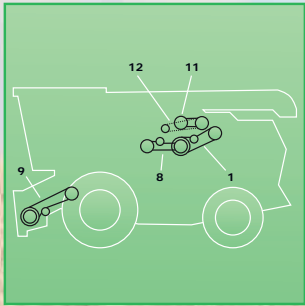

## CASE INTL. HARVESTER

### 1420

	STRAW CHOPPER DRIVE	182945C1	1	1000737	4014486471328
	RH SIDE DRIVE W/ DISCHARGE BEATER	183049C1	1	1001380	4014486474954
	RH SIDE DRIVE W/ STRAW CHOPPER	186509C2	1	1001379	4014486474947
	AUXILIARY PUMP DRIVE	191288C2	1	1000614	4014486469523
	COMPRESSOR DRIVE	280210C2	1	1000115	4014486461237
	STRAW SPREADER DRIVE	589622R1	1	1000421	4014486466843
	FAN DRIVE	599060R1	1	1001411	4014486459180
	TAILINGS ELEV. DRIVE	674965R1	1	1000633	4014486469868

### 1620

2	AIR CONDITIONING COMPRESSOR DRIVE	280210C2	1	1000115	4014486461237
2	AIR CONDITIONING COMPRESSOR DRIVE	874097C1	1	1000051	4014486483710
3	STRAW SPREADER DRIVE	589622R1	1	1000421	4014486466843
5	STRAW CHOPPER DRIVE	182945C1	1	1000737	4014486471328
7	FEEDER DRIVE	186509C2	1	1001379	4014486474947
8	CLEANING FAN DRIVE	599060R1	1	1001411	4014486459180
9	ELEVATOR DRIVE UNIT	183049C1	1	1001380	4014486474954
10	SEPARATOR DRIVE	191241C3	1	1001142	4014486490053
16	CLEANING UNIT DRIVE WITH STRAW CHOPPER	186509C2	1	1001379	4014486474947

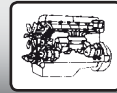
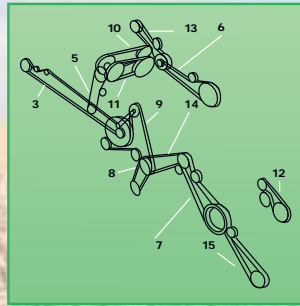
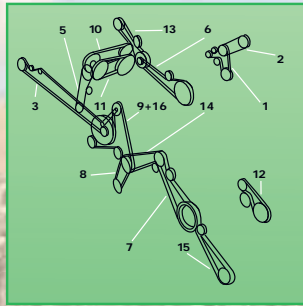
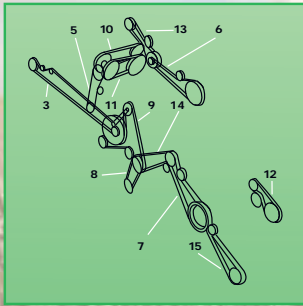

## CASE INTL. HARVESTER

### 1640

1	ALTERNATOR, FAN AND WATERPUMP DRIVE	J911562	1	1004155	4014486523041
2	AIR CONDITIONING COMPRESSOR DRIVE	164550R2	1	1000102	4014486461046
3	STRAW SPREADER DRIVE	196371C1	1	1000423	4014486466867
5	STRAW CHOPPER DRIVE	1315265C1	1	1001602	4014486485240
5	STRAW CHOPPER DRIVE	1347157C1	1	1001610	4014486485387
6	UNLOADING AUGER DRIVE	191290C1	1	1000708	4014486470956
7	FEEDER DRIVE WITHOUT ROCK TRAP	192738C1	1	1003473	4014486519778
8	CLEANING FAN DRIVE	195396C2	1	1001417	4014486459241
9	ELEVATOR DRIVE UNIT	181055C1	1	1001374	4014486474886
9	ELEVATOR DRIVE UNIT	186509C2	1	1001379	4014486474947
10	SEPARATOR DRIVE	191241C3	1	1001142	4014486490053
12	REEL DRIVE PUMP	1321565C1	1	1002320	4014486480085
13	AUXILIARY PUMP DRIVE	1347387C1	1	1001602	4014486485240
14	FAN JACKSHAFT DRIVE	191305C1	1	1000654	4014486470178
16	CLEANING UNIT DRIVE WITH STRAW CHOPPER	181055C1	1	1001374	4014486474886
20	FAN JACKSHAFT SLOW SPEED	610521R1	1	1003416	4014486463620

### 1644

	COMPRESSOR, A/C	1250587C1	1	1003476	4014486519242
	STRAW CHOPPER DRIVE	1315265C1	1	1001602	4014486485240
	AUXILLIARY PUMP DRIVE	1347387C1	1	1001602	4014486485240
	CLEANING FAN DRIVE	1541569C1	1	1003472	4014486518320
	ELEVATOR DRIVE	181055C1	1	1001374	4014486474886
	ELEVATOR DRIVE W/DISCHARGE BEATER	186509C2	1	1001379	4014486474947
	CLEANING FAN JACKSHAFT DRIVE	191305C1	1	1000654	4014486470178
	STRAW SPREADER DRIVE	196371C1	1	1000423	4014486466867

### 1660

1	ALTERNATOR, FAN AND WATERPUMP DRIVE	J911572	1	1003140	4014486480962
2	AIR CONDITIONING COMPRESSOR DRIVE	164550R2	1	1000102	4014486461046
2	AIR CONDITIONING COMPRESSOR DRIVE	396829R1	1	1003475	4014486519228
3	STRAW SPREADER DRIVE	196371C1	1	1000423	4014486466867
5	STRAW CHOPPER DRIVE	1315265C1	1	1001602	4014486485240
5	STRAW CHOPPER DRIVE	1347157C1	1	1001610	4014486485387
6	UNLOADING AUGER DRIVE	191290C1	1	1000708	4014486470956
7	FEEDER DRIVE WITHOUT ROCK TRAP	192738C1	1	1003473	4014486519778
8	CLEANING FAN DRIVE	1541569C1	1	1003472	4014486518320
8	CLEANING FAN DRIVE	195396C2	1	1001417	4014486459241
9	ELEVATOR DRIVE UNIT	181055C1	1	1001374	4014486474886
9	ELEVATOR DRIVE UNIT	186509C2	1	1001379	4014486474947
10	SEPARATOR DRIVE	191241C3	1	1001142	4014486490053
12	REEL DRIVE PUMP	1321565C1	1	1002320	4014486480085
13	AUXILIARY PUMP DRIVE	1347387C1	1	1001602	4014486485240
14	FAN JACKSHAFT DRIVE	191305C1	1	1000654	4014486470178
16	CLEANING UNIT DRIVE WITH STRAW CHOPPER	181055C1	1	1001374	4014486474886
20	FAN JACKSHAFT SLOW SPEED	610521R1	1	1003416	4014486463620
21	CHAFF SPREADER DRIVE (UPPER)	123305A1	1	1000432	4014486466997

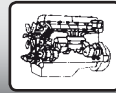
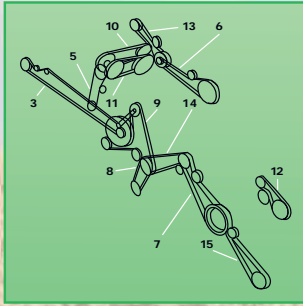

## CASE INTL. HARVESTER

### 1666

1	COMPRESSOR, A/C	396829R1	1	1003475	4014486519228
2	FAN, ALTERNATOR, WATER PUMP	J911572	1	1003140	4014486480962
6	AUXILLIARY PUMP DRIVE	1347387C1	1	1001602	4014486485240
7	STRAW CHOPPER DRIVE	1315265C1	1	1001602	4014486485240
10	CLEANING FAN JACKSHAFT DRIVE	191305C1	1	1000654	4014486470178
11	CLEANING FAN DRIVE	1541569C1	1	1003472	4014486518320
12	STRAW SPREADER DRIVE	196371C1	1	1000423	4014486466867
13	ELEVATOR DRIVE	181055C1	1	1001374	4014486474886
13	ELEVATOR DRIVE W/DISCHARGE BEATER	186509C2	1	1001379	4014486474947

### 1680

1	ALTERNATOR, FAN AND WATERPUMP DRIVE	J911572	1	1003140	4014486480962
2	AIR CONDITIONING COMPRESSOR DRIVE	1250587C1	1	1003476	4014486519242
2	AIR CONDITIONING COMPRESSOR DRIVE	396829R1	1	1003475	4014486519228
3	STRAW SPREADER DRIVE	196371C1	1	1000423	4014486466867
5	STRAW CHOPPER DRIVE	1315266C1	1	1001620	4014486485516
5	STRAW CHOPPER DRIVE	1347160C1	1	1001625	4014486485646
6	UNLOADING AUGER DRIVE	191291C1	1	1000723	4014486471151
6	UNLOADING AUGER DRIVE	1989217C1	1	1000728	4014486471205
7	FEEDER DRIVE WITH ROCK TRAP	1315074C1	1	1001147	4014486490114
8	CLEANING FAN DRIVE	1541569C1	1	1003472	4014486518320
8	CLEANING FAN DRIVE	195396C2	1	1001417	4014486459241
9	ELEVATOR DRIVE UNIT	186509C2	1	1001379	4014486474947
10	SEPARATOR DRIVE	1541702C1	1	1001145	4014486490084
10	SEPARATOR DRIVE	191244C1	1	1001879	4014486489286
11	ROTOR VARIATOR DRIVE	244422A1	1	1001533	4014486460520
12	REEL DRIVE PUMP	1321565C1	1	1002320	4014486480085
12	REEL DRIVE PUMP (54.5)	1321565C1	1	1002320	4014486480085
13	AUXILIARY PUMP DRIVE	1347358C1	1	1001604	4014486485295
13	AUXILIARY PUMP DRIVE	1541700C1	1	1001600	4014486485226
14	FAN JACKSHAFT DRIVE	188213C1	1	1000692	4014486470710
15	FEEDER JACKSHAFT DRIVE	1308489C2	1	1003573	4014486490091
16	CLEANING UNIT DRIVE WITH STRAW CHOPPER	181055C1	1	1001374	4014486474886
20	FAN JACKSHAFT SLOW SPEED	610521R1	1	1003416	4014486463620
21	CHAFF SPREADER DRIVE (UPPER)	123305A1	1	1000432	4014486466997
22	CHAFF SPREADER DRIVE (LOWER)	123307A1	1	1002309	4014486479973

### 1688

	FEEDER JACKSHAFT DRIVE W/60" FEEDER	1308489C2	1	1003573	4014486490091
	FEEDER DRIVE W/ROCK TRAP	1315074C1	1	1001147	4014486490114
	STRAW CHOPPER DRIVE	1315266C1	1	1001620	4014486485516
	CLEANING FAN DRIVE	1541569C1	1	1003472	4014486518320
	AUXILLIARY PUMP DRIVE	1541700C1	1	1001600	4014486485226
	SEPARATOR DRIVE	1541702C1	1	1001145	4014486490084
	ELEVATOR DRIVE	181055C1	1	1001374	4014486474886
	ELEVATOR DRIVE W/DISCHARGE BEATER	186509C2	1	1001379	4014486474947
	CLEANING FAN JACKSHAFT DRIVE	188213C1	1	1000692	4014486470710
	STRAW SPREADER DRIVE	196371C1	1	1000423	4014486466867
	GRAIN TANK UNLOADING	1989217C1	1	1000728	4014486471205
	COMPRESSOR, A/C	396829R1	1	1003475	4014486519228
	FAN, ALTERNATOR, WATER PUMP	J911572	1	1003140	4014486480962

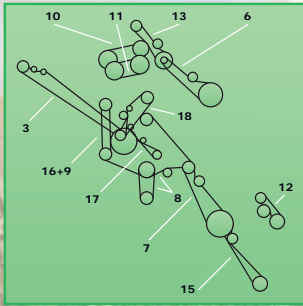

AG - BI  
 CA - CL  
 DE - DR  
 FE - FO  
 GO - GR  
 IN - JO  
 KP - KZ  
 LA - ME  
 NE - RO  
 SA - ST  
 VA - ZM  
 SERVICE PARTS



## CASE INTL. HARVESTER

2144					
	AUXILLIARY PUMP DRIVE	124573A1	1	1001600	4014486485226
	COMPRESSOR, A/C	1250587C1	1	1003476	4014486519242
	FEEDER JACKSHAFT DRIVE W/60" FEEDER	1308489C2	1	1003573	4014486490091
	STRAW CHOPPER DRIVE	1315265C1	1	1001602	4014486485240
	CLEANING FAN DRIVE	1541569C1	1	1003472	4014486518320
	ELEVATOR DRIVE W/DISCHARGE BEATER	186509C2	1	1001379	4014486474947
	STRAW SPREADER DRIVE	196371C1	1	1000423	4014486466867
2166					
1	ALTERNATOR, FAN AND WATERPUMP DRIVE	J911572	1	1003140	4014486480962
2	AIR CONDITIONING COMPRESSOR DRIVE	396829R1	1	1003475	4014486519228
3	STRAW SPREADER DRIVE	196371C1	1	1000423	4014486466867
5	STRAW CHOPPER DRIVE	1347157C1	1	1001610	4014486485387
6	UNLOADING AUGER DRIVE	191290C1	1	1000708	4014486470956
7	FEEDER DRIVE WITHOUT ROCK TRAP	192738C1	1	1003473	4014486519778
8	CLEANING FAN DRIVE	1541569C1	1	1003472	4014486518320
9	ELEVATOR DRIVE UNIT	186509C2	1	1001379	4014486474947
10	SEPARATOR DRIVE	191241C3	1	1001142	4014486490053
13	AUXILIARY PUMP DRIVE	124572A1	1	1001599	4014486485202
14	FAN JACKSHAFT DRIVE	191305C1	1	1000654	4014486470178
15	FEEDER JACKSHAFT DRIVE	1308489C2	1	1003573	4014486490091
16	CLEANING UNIT DRIVE	181055C1	1	1001374	4014486474886
21	CHAFF SPREADER DRIVE (UPPER)	123305A1	1	1000432	4014486466997
22	CHAFF SPREADER DRIVE (LOWER)	123306A1	1	1002307	4014486479959
2188					
	CHAFF SPREADER DRIVE (UPPER)	123305A1	1	1000432	4014486466997
	CHAFF SPREADER DRIVE (LOWER)	123307A1	1	1002309	4014486479973
	AUXILIARY PUMP DRIVE	124573A1	1	1001600	4014486485226
	FEEDER JACKSHAFT DRIVE	1308489C2	1	1003573	4014486490091
	FEEDER DRIVE WITH ROCK TRAP	1315074C1	1	1001147	4014486490114
	STRAW CHOPPER DRIVE	1347160C1	1	1001625	4014486485646
	CLEANING FAN DRIVE	1541569C1	1	1003472	4014486518320
	SEPARATOR DRIVE	1541702C1	1	1001145	4014486490084
	CLEANING UNIT DRIVE	181055C1	1	1001374	4014486474886
	ELEVATOR DRIVE UNIT	186509C2	1	1001379	4014486474947
	FAN JACKSHAFT DRIVE	188213C1	1	1000692	4014486470710
	STRAW SPREADER DRIVE	196371C1	1	1000423	4014486466867
	ROTOR VARIATOR DRIVE	244422A1	1	1001533	4014486460520
	AIR CONDITIONING COMPRESSOR DRIVE	396829R1	1	1003475	4014486519228
	ALTERNATOR, FAN AND WATERPUMP DRIVE	J911572	1	1003140	4014486480962
2365					
	AUXILIARY PUMP DRIVE	124572A1	1	1001599	4014486485202
	FEEDER JACKSHAFT DRIVE	1308489C2	1	1003573	4014486490091
	STRAW CHOPPER DRIVE	1347157C1	1	1001610	4014486485387
	CLEANING UNIT DRIVE	181055C1	1	1001374	4014486474886
	ELEVATOR DRIVE UNIT	186509C2	1	1001379	4014486474947
	SEPARATOR DRIVE	191241C3	1	1001142	4014486490053
	UNLOADING AUGER DRIVE	191290C1	1	1000708	4014486470956
	FEEDER DRIVE WITHOUT ROCK TRAP	192738C1	1	1003473	4014486519778
	STRAW SPREADER DRIVE	196371C1	1	1000423	4014486466867
	FAN JACKSHAFT DRIVE	301111A1	1	No AP	

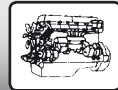

## CASE INTL. HARVESTER

	CLEANING FAN DRIVE	301146A1	1	1003931	4014486520118
	AIR CONDITIONING COMPRESSOR DRIVE	396829R1	1	1003475	4014486519228
	ALTERNATOR, FAN AND WATERPUMP DRIVE	J911572	1	1003140	4014486480962
<b>2366</b>					
	AUXILIARY PUMP DRIVE	124572A1	1	1001599	4014486485202
	FEEDER JACKSHAFT DRIVE	1308489C2	1	1003573	4014486490091
	STRAW CHOPPER DRIVE	1347157C1	1	1001610	4014486485387
	CLEANING UNIT DRIVE	181055C1	1	1001374	4014486474886
	ELEVATOR DRIVE UNIT	186509C2	1	1001379	4014486474947
	SEPARATOR DRIVE	191241C3	1	1001142	4014486490053
	UNLOADING AUGER DRIVE	191290C1	1	1000708	4014486470956
	FEEDER DRIVE WITHOUT ROCK TRAP	192738C1	1	1003473	4014486519778
	STRAW SPREADER DRIVE	196371C1	1	1000423	4014486466867
	FAN JACKSHAFT DRIVE	301111A1	1	No AP	
	CLEANING FAN DRIVE	301146A1	1	1003931	4014486520118
	AIR CONDITIONING COMPRESSOR DRIVE	396829R1	1	1003475	4014486519228
	ALTERNATOR, FAN AND WATERPUMP DRIVE	J911572	1	1003140	4014486480962
<b>2388</b>					
	ELEVATOR DRIVE UNIT	186509C2	1	1001379	4014486474947
	STRAW SPREADER DRIVE	196371C1	1	1000423	4014486466867
	DISCHARGE DRIVE GRAIN TANK	1989217C1	1	1000728	4014486471205
	AIR CONDITIONING COMPRESSOR DRIVE	235414A1	1	1002515	4014486494297
	CLEANING FAN DRIVE	301146A1	1	1003931	4014486520118
	CLEANING FAN - JACKSHAFT	317904A1	1	1004097	4014486518795
	SEPARATOR DRIVE	400427A1	1	1001216	4014486492422
	FEEDER JACKSHAFT DRIVE	402368A1	1	1001169	4014486491807
	ROTOR DRIVE	413159A1	1	1001535	4014486460544
	AUXILIARY PUMP DRIVE	440498A3	1	1004116	4014486523867
	ENGINE FAN AND ALTERNATOR	A78022	1	1003195	4014486481884
<b>4030</b>					
	FAN BELT	4796327	1	1002461	4014486493450
<b>4230</b>					
	FAN BELT	4796327	1	1002461	4014486493450
<b>4430</b>					
	FAN BELT	4796327	1	1002461	4014486493450
<b>4835</b>					
	FAN BELT	4796327	1	1002461	4014486493450
<b>5530</b>					
	FAN BELT	4796327	1	1002461	4014486493450
<b>5635</b>					
	FAN BELT	4796327	1	1002461	4014486493450
<b>6530</b>					
	FAN BELT	4796327	1	1002461	4014486493450
<b>6635</b>					
	FAN BELT	4796327	1	1002461	4014486493450

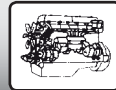

## CASE INTL. HARVESTER

7635

FAN BELT					
CASE INTL. HARVESTER					
		21486	1	1002441	4014486493191
		60010	1	1002470	4014486493566
		66232	1	1000690	4014486470697
		130012	1	1002571	4014486495379
		130013	2	1002975	4014486495966
		130071	1	1002561	4014486495119
		130072	1	1002595	4014486495980
		142273	1	1000016	4014486483338
		159837	3	1004261	4014486682946
		178623	1	1004701	4014486719802
		186347	1	1003809	4014486518740
		219498	1	1004696	4014486714234
		230056	1	1003232	4014486518658
		230077	1	1001489	4014486459999
		230078	1	1001509	4014486460254
		270174	2	1000030	4014486483529
		274224	4	1004646	4014486718997
		314115	1	1001494	4014486460063
		321559	1	1001512	4014486460308
		323646	1	1001949	4014486490541
		326298	1	1003489	4014486468427
		330715	1	1000726	4014486471182
		333958	1	1000715	4014486471052
		334065	1	1001403	4014486459098
		350236	1	1003640	4014486489002
		356024	1	1001489	4014486459999
		356025	1	1001525	4014486460445
		378989	2	1002821	4014486463606
		381236	2	1002944	4014486495294
		381237	1	1002567	4014486495270
		387469	1	1000700	4014486470833
		388280	1	1001410	4014486459173
		393519	1	1002593	4014486495904
		399058	2	1004630	4014486716726
		421173	1	1002556	4014486494983
		422731	1	1000696	4014486470772
		424563	1	1001765	4014486487480
		427456	1	1003351	4014486464603
		431784	1	1000328	4014486465587
		432642	1	1003746	4014486495928
		433746	2	1000405	4014486466683
		433747	1	1003252	4014486518573
		434044	1	1003669	4014486491364
		434222	1	1001635	4014486485837
		437033	2	1002878	4014486468991
		439129	1	1003586	4014486460049
		440780	1	No AP	
		444045	1	1002554	4014486494914
		446969	1	1001489	4014486459999
		446970	1	1001496	4014486460094



## CASE INTL. HARVESTER

	446971	1	1003470	4014486518368
	447031	1	1001872	4014486489132
	452022	1	1002595	4014486495980
	456216	1	1002575	4014486495478
	457643	1	1000159	4014486461817
	516776	1	1000349	4014486466041
	600021	1	1002495	4014486494006
	600101	1	1002471	4014486493573
	602211	1	1002531	4014486494501
	603720	1	1003584	4014486459128
	677419	1	1004402	4014486714685
	709998	1	1004413	4014486714784
	717699	1	1003882	4014486485790
	743877	1	1001980	4014486490992
	746894	1	1001695	4014486486711
	748003	2	1002974	4014486495935
	753053	1	1000706	4014486470925
	754165	1	1002415	4014486494280
	754388	1	1003341	4014486462999
	754389	1	1003338	4014486465402
	754423	1	1000660	4014486470246
	755808	1	1001487	4014486459982
	756900	1	1004477	4014486715767
	797475	1	1000998	4014486520460
	825013	1	1001562	4014486484632
	835683	1	1002667	4014486482416
	851791	1	1004631	4014486721324
	851792	1	1001180	4014486490183
	857938	1	No AP	
	861731	1	1003978	4014486518498
	900611	1	1002532	4014486494525
	904011	1	1001629	4014486485714
	904027	1	1001741	4014486487251
	904029	1	1001718	4014486487008
	904031	1	1001724	4014486487077
	904038	1	1001729	4014486487138
	913524	1	1000412	4014486466751
	918062	2	1004630	4014486716726
	921330	1	1000785	4014486472011
	922911	1	1002004	4014486491319
	938787	1	1002543	4014486494723
	1112638	1	1003948	4014486497649
	1113390	1	1001005	4014486487879
	1113831	1	1001259	4014486492187
	1113936	1	1002567	4014486495270
	1113985	1	1003582	4014486475050
	1114295	1	1001177	4014486497496
	1114568	1	1003623	4014486487503
	1114576	1	1001729	4014486487138
	1169428	1	1001938	4014486490350
	1169983	1	1001231	4014486491845
	1169991	1	1001319	4014486492811
	1170003	1	1001313	4014486492767
	1170011	1	1001997	4014486491227
	1170028	1	1001993	4014486491166





## CASE INTL. HARVESTER

	1170036	1	1001230	4014486491838
	1170044	1	1001797	4014486488050
	1170060	1	1001798	4014486488067
	1170116	1	1001322	4014486492842
	1170124	1	1001323	4014486492859
	1170140	1	1001710	4014486486889
	1170157	1	1002674	4014486482140
	1170181	1	1001318	4014486492804
	1170204	1	1001310	4014486492712
	1300721	1	1003747	4014486495973
	1301131	1	1002598	4014486496031
	1590486	2	1004760	4014486719239
	1725666	2	1004758	4014486719215
	1791046	1	1002582	4014486495638
	2213342	1	1004838	4014486719345
	2853208	1	1003158	4014486481204
	2855970	1	1002651	4014486481143
	2856151	1	1003162	4014486481341
	2900435	1	1002343	4014486478761
	2928981	1	1004820	4014486719390
	2929681	1	1002528	4014486494471
	2929932	1	1004818	4014486719376
	2976405	1	1003364	4014486483406
	3012326	1	1004819	4014486719383
	3140006	1	1002544	4014486494747
	3140053	1	1002567	4014486495270
	3140058	1	1002534	4014486494556
	3140085	1	1002475	4014486493627
	3140109	3	1002986	4014486494617
	3142286	1	1000005	4014486483208
	3142287	1	1000008	4014486483253
	3142590	1	1002507	4014486494129
	3143002	1	1000021	4014486483413
	3145900	1	1002506	4014486494112
	3288757	1	1004871	4014486716382
	3288768	1	1004871	4014486716382
	3288812	1	1004155	4014486523041
	3288867	1	1003190	4014486481815
	3288922	1	1003138	4014486480948
	3288999	1	1004095	4014486481112
	3289078	1	1003749	4014486481228
	3289224	1	1002658	4014486481433
	3289279	1	1003170	4014486481471
	3289481	1	1003176	4014486481570
	3289593	1	1003183	4014486481662
	3289604	1	1003183	4014486481662
	3289648	1	1003186	4014486481730
	3289768	1	1003195	4014486481884
	3290158	1	1003191	4014486481846
	3781694	1	1003431	4014486464313
	3795185	1	1000702	4014486470857
	4760486	1	1004712	4014486716597
	5095203	1	1002460	4014486493436
	6500261	2	1002944	4014486495294
	8403632	1	1003914	4014486475388



## CASE INTL. HARVESTER

	8403693	1	1002050	4014486475265
	8520042	1	1004500	4014486717044
	8602680	1	1002643	4014486480689
	9501182	1	1002579	4014486495560
	9501863	2	1002960	4014486495003
	9502828	1	1001053	4014486484403
	9506748	1	1002510	4014486494174
	9508557	2	1002945	4014486495492
	9508558	2	1002946	4014486494938
	9513984	1	1003345	4014486469844
	9514310	1	1000152	4014486461725
	9575059	1	1002571	4014486495379
	9575153	2	1002879	4014486471434
	9593418	1	1000813	4014486472370
	9593440	1	1000816	4014486472417
	9593464	1	1002031	4014486491661
	9604339	1	1002567	4014486495270
	9800111	1	1000713	4014486471038
	9814069	1	1001557	4014486484564
	9817374	1	1001876	4014486489231
	9818705	1	1000079	4014486484007
	9819676	1	1000672	4014486470420
	9829162	1	No AP	
	9831571	1	1003668	4014486491333
	9833619	1	1003137	4014486519884
	9833888	1	No AP	
	9835120	1	1001781	4014486487688
	9835683	1	1002667	4014486482416
	9835815	1	1003733	4014486495386
	9837412	1	1000573	4014486468816
	9839375	1	1000774	4014486471830
	9850080	1	1004079	4014486520446
	20471086	1	1001000	4014486497236
	20797305	1	1003650	4014486489354
	20797483	1	1001202	4014486497588
	20797491	1	1001205	4014486497625
	31295188	1	1001872	4014486489132
	31301147	1	1001704	4014486486810
	31302068	1	1002256	4014486478235
	31302076	1	1002670	4014486482089
	31310695	2	1003051	4014486479300
	31314408	1	1002674	4014486482140
	31314408	1	1002674	4014486482140
	31317917	2	1002808	4014486465280
	31318645	1	1002018	4014486491524
	31318645	1	1002018	4014486491524
	31343437	1	1001574	4014486484793
	31360374	2	1003037	4014486477696
	47406268	1	1004391	4014486714562
	47413433	1	1004438	4014486715378
	47414501	1	1004640	4014486718607
	47415905	1	1004577	4014486717693
	47419045	1	1000691	4014486470703
	47441074	1	1004286	4014486683165
	50404925	1	1004257	4014486676198



## CASE INTL. HARVESTER

	51400100	1	1002457	4014486493405
	60038063	1	1001892	4014486489507
	60067590	1	1001901	4014486489613
	60068286	1	1001869	4014486489095
	60121284	1	1001513	4014486460322
	60124334	1	1001944	4014486490442
	60183586	1	1001211	4014486497700
	60183586	1	1001211	4014486497700
	60186515	1	1001883	4014486489347
	60186515	1	1001883	4014486489347
	60203060	1	1001863	4014486489026
	60517253	1	1002560	4014486495102
	60517261	2	1003773	4014486495065
	60518004	2	1002978	4014486494570
	60520763	1	1001894	4014486489538
	61004680	1	1002002	4014486491289
	61020978	1	1001900	4014486489606
	61063633	1	1002010	4014486491401
	61068927	1	1001246	4014486492026
	61068935	1	1001866	4014486489064
	61068943	1	1001241	4014486491951
	61068968	1	1001308	4014486492682
	72023391	1	1001220	4014486497755
	72048753	1	1001317	4014486497908
	73180336	1	1000060	4014486483802
	80046914	1	1003508	4014486469240
	80159837	3	1004261	4014486682946
	80347469	1	1000700	4014486470833
	80354115	1	1001494	4014486460063
	80392361	1	1003661	4014486490657
	80396749	1	1003467	4014486518641
	80433747	1	1003252	4014486518573
	80437607	1	No AP	
	80443635	1	1002460	4014486493436
	80446969	1	1001489	4014486459999
	80446970	1	1001496	4014486460094
	80449701	1	1000426	4014486466898
	80452022	1	1002595	4014486495980
	80452023	2	1003776	4014486496000
	80453267	1	1003311	4014486518559
	80516776	1	1000349	4014486466041
	80531558	2	1003509	4014486469271
	80543226	3	1004377	4014486716764
	80565498	1	1002132	4014486476378
	80603720	1	1001405	4014486459111
	80727852	1	1003508	4014486469240
	80746889	1	1000735	4014486471311
	80746890	1	1000744	4014486471403
	80746891	1	1000798	4014486472172
	80746893	1	1001647	4014486485998
	80746894	1	1001695	4014486486711
	80749144	1	1000559	4014486468564
	80749145	3	1002822	4014486464740
	80754423	1	1000660	4014486470246
	80851791	1	1004631	4014486721324



## CASE INTL. HARVESTER

	80851792	1	1001180	4014486490183
	80913524	1	1000412	4014486466751
	80921330	1	1000785	4014486472011
	80980001	1	No AP	
	81549846	1	1002546	4014486494761
	81718144	1	1002549	4014486494815
	81718146	1	1000055	4014486483758
	81845565	1	1003728	4014486495140
	82007330	1	1004258	4014486676174
	82010895	1	1002619	4014486480122
	82012177	1	1002619	4014486480122
	82021010	1	1004260	4014486676167
	82850752	1	1002639	4014486480528
	82850752	1	1002639	4014486480528
	83949803	1	1002506	4014486494112
	84000190	1	1001694	4014486486704
	84001336	1	1001776	4014486487626
	84002709	1	1000583	4014486469035
	84005357	1	1002758	4014486463156
	84005861	1	1002638	4014486480511
	84005971	1	1000826	4014486472523
	84005972	1	1000829	4014486472554
	84007006	1	1001766	4014486519570
	84007677	1	1001783	4014486519648
	84012390	1	1002026	4014486491616
	84012562	1	1004612	4014486717426
	84017753	1	1003038	4014486519860
	84018998	1	1000831	4014486472578
	84019041	1	1000730	4014486471229
	84019385	1	1000834	4014486472608
	84021589	2	1004052	4014486484045
	84023913	1	1002678	4014486482201
	84024926	1	1003366	4014486460872
	84026668	1	1000667	4014486470345
	84026762	1	1003001	4014486518429
	84026892	1	1000571	4014486468793
	84036578	1	1002929	4014486519853
	84036579	2	1001165	4014486491760
	84038109	1	1000618	4014486469585
	84041069	1	1001711	4014486486896
	84041070	1	1001707	4014486486841
	84041094	1	1001712	4014486486902
	84041095	1	1001708	4014486486858
	84042180	1	No AP	
	84043106	2	1002823	4014486464788
	84043107	1	1002928	4014486518528
	84045018	1	1000712	4014486471021
	84045444	3	1000311	4014486465204
	84045751	1	1002602	4014486496093
	84045959	1	1000672	4014486470420
	84054417	1	1001007	4014486487893
	84056914	1	1002927	4014486518504
	84057609	2	1000294	4014486464856
	84057610	1	1002720	4014486518535
	84058063	1	No AP	

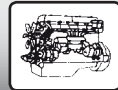

## CASE INTL. HARVESTER

	84058255	1	1000650	4014486470123
	84073615	2	1002824	4014486464962
	84074272	1	1002659	4014486519167
	84074273	8	1002145	4014486476590
	84075053	1	1002691	4014486518542
	84075677	4	1001342	4014486474541
	84075683	1	1002172	4014486519006
	84078581	1	No AP	
	84127377	1	1004629	4014486719543
	84137560	1	No AP	
	84137965	1	1004511	4014486717211
	84139175	1	1004498	4014486717013
	84148387	1	1001249	4014486492057
	84168012	1	1004128	4014486523102
	84171789	1	1004314	4014486717181
	84172256	1	1004444	4014486715439
	84175581	1	1001636	4014486485844
	84175582	1	No AP	
	84180490	1	1004425	4014486714968
	84185033	1	1002556	4014486494983
	84185053	1	1002543	4014486494723
	84188121	1	1003643	4014486489156
	84188501	1	No AP	
	84191907	1	1001767	4014486487510
	84192753	1	1004546	4014486719673
	84194650	1	No AP	
	84215838	1	1002689	4014486482928
	84223612	1	1002627	4014486480207
	84226318	1	1000674	4014486470468
	84238513	1	1003718	4014486519365
	84240788	2	1002971	4014486495423
	84243629	1	1002521	4014486494389
	84254480	1	1001865	4014486489057
	84254495	1	1001837	4014486488630
	84256364	1	1004466	4014486715675
	84256369	1	1004850	4014486717204
	84257945	1	1003189	4014486481785
	84262973	1	1003935	4014486491029
	84262995	1	No AP	
	84271496	1	1002506	4014486494112
	84274885	1	1004533	4014486718829
	84284322	1	1003936	4014486484649
	84284468	1	1003937	4014486486520
	84286546	1	1003938	4014486496062
	84286835	1	1004520	4014486717266
	84287970	1	1003939	4014486486049
	84296393	1	1004653	4014486718676
	84298887	1	1004583	4014486717754
	84298895	1	1004581	4014486717730
	84299873	1	1004310	4014486719604
	84311543	1	1004006	4014486519402
	84320459	1	1000671	4014486470390
	84342685	1	1003977	4014486519037
	84342686	1	1003976	4014486519051
	84346830	1	1003940	4014486481532

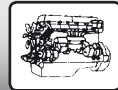

## CASE INTL. HARVESTER

	84352807	1	1001685	4014486486605
	84352808	1	1004286	4014486683165
	84356659	1	1004628	4014486719536
	84365709	1	1004826	4014486719321
	84373502	1	1003200	4014486481952
	84376536	1	1001603	4014486485257
	84381274	1	1004186	4014486554373
	84384813	1	No AP	
	84394081	1	1004503	4014486717556
	84397971	1	1002644	4014486480696
	84398996	1	1001823	4014486488425
	84398997	1	No AP	
	84398998	1	1004574	4014486717648
	84411381	1	1001560	4014486484595
	84423385	1	1003240	4014486482737
	84435248	1	1001187	4014486490251
	84440188	1	1000806	4014486472295
	84448759	1	1004650	4014486718645
	84449048	1	1004602	4014486717952
	84449232	1	1004649	4014486721348
	84449233	1	1004648	4014486721331
	84449518	1	1003741	4014486495713
	84449662	1	1003355	4014486470321
	84449861	1	1004654	4014486718683
	84452723	2	1004836	4014486714876
	84452979	2	1004836	4014486714876
	84455757	2	1004833	4014486714579
	84455758	2	1000265	4014486464207
	84455765	2	1004833	4014486714579
	84455766	2	1000265	4014486464207
	84457069	1	1004698	4014486721355
	84458482	1	1004669	4014486719703
	84459680	1	1004605	4014486718515
	84472848	1	No AP	
	84493479	1	No AP	
	84493480	1	No AP	
	84511734	1	1004652	4014486718669
	84513766	1	1001560	4014486484595
	84514757	1	1001838	4014486488647
	84518497	1	1002627	4014486480207
	84522809	1	No AP	
	84531713	1	1003719	4014486519297
	84533502	1	1004006	4014486519402
	84582506	1	1004575	4014486717662
	84582509	1	1004623	4014486717532
	84589012	1	No AP	
	84589013	1	No AP	
	84590653	1	1003170	4014486481471
	84814035	1	1001188	4014486490268
	84817621	1	1000620	4014486469608
	84817622	1	1000750	4014486471472
	84817624	1	1003341	4014486462999
	84817625	1	1000321	4014486465419
	84817633	1	1003346	4014486486124
	84817634	1	1002026	4014486491616

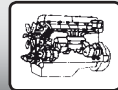

## CASE INTL. HARVESTER

	84817637	1	1003617	4014486486780
	84817638	1	1003807	4014486483048
	84817640	1	No AP	
	84981849	1	1003586	4014486460049
	84993224	1	1001488	4014486459975
	84996134	1	1001715	4014486486964
	84999531	1	1001168	4014486491791
	85826230	1	1003129	4014486480832
	86011009	1	1004690	4014486716412
	86514512	1	1004374	4014486714197
	86514520	1	1000232	4014486463262
	86514611	1	1002539	4014486494648
	86514615	1	1002506	4014486494112
	86514616	1	1004723	4014486716498
	86516699	1	1004879	4014486716580
	86517680	1	1001853	4014486488876
	86518569	1	No AP	
	86547070	1	1001713	4014486486919
	86566286	1	1001627	4014486485660
	86566606	1	1001978	4014486490954
	86582818	1	1004615	4014486717457
	86595191	1	1000345	4014486465969
	86596143	1	No AP	
	86610860	1	No AP	
	86627791	1	1001942	4014486490428
	86627796	1	1003356	4014486486131
	86627797	1	No AP	
	86627808	1	1004609	4014486717396
	86627809	1	1004608	4014486717969
	86629764	1	1004414	4014486714791
	86633896	1	1000607	4014486469455
	86634492	1	1001350	4014486474633
	86982450	1	1003132	4014486480894
	86988710	1	1001616	4014486485462
	87012453	1	1001969	4014486490800
	87027209	1	1000671	4014486470390
	87030923	1	1004613	4014486717433
	87031779	1	1004127	4014486523096
	87061270	1	1000667	4014486470345
	87061591	1	1000642	4014486470017
	87282305	1	1004182	4014486523850
	87283139	1	1001373	4014486474879
	87301455	1	1004898	
	87309958	1	1002664	4014486481945
	87316555	1	1002647	4014486480863
	87316556	1	1002636	4014486480405
	87325327	1	1004793	4014486719505
	87330903	1	1001616	4014486485462
	87346514	1	1004497	4014486717006
	87346859	1	1002601	4014486496086
	87354138	1	1003171	4014486481488
	87354141	1	1004851	4014486716542
	87366024	1	1003698	4014486494099
	87368902	1	1001680	4014486486506
	87373569	1	1002530	4014486494495



## CASE INTL. HARVESTER

	87374574	1	1004722	4014486716733
	87375325	1	1004548	4014486719697
	87393905	1	1001558	4014486484571
	87397416	1	1003165	4014486481372
	87415774	1	1003126	4014486480795
	87429954	1	1002552	4014486494877
	87456836	2	1003044	4014486479850
	87476486	1	1004065	4014486519020
	87476487	1	1004064	4014486519044
	87491779	1	1004252	4014486675993
	87518813	1	1000103	4014486461053
	87519458	1	1003816	4014486481693
	87526139	1	1002589	4014486495836
	87526140	2	1002590	4014486495850
	87527868	1	1004591	4014486717839
	87528118	6	1004692	4014486719413
	87528805	1	1000730	4014486471229
	87531466	6	1004692	4014486719413
	87540195	1	No AP	
	87549556	1	1001841	4014486488708
	87564450	1	1001620	4014486485516
	87564452	1	1001616	4014486485462
	87564549	1	1001616	4014486485462
	87567471	1	1004773	4014486716559
	87572660	1	1004406	4014486714722
	87583899	1	1001877	4014486489255
	87628477	1	1003356	4014486486131
	87628478	1	1003618	4014486486865
	87630521	1	1003132	4014486480894
	87641387	1	1004369	4014486714135
	87642957	1	1000693	4014486470741
	87653464	1	1004383	4014486714531
	87655953	1	No AP	
	87656225	1	1004357	4014486714012
	87656270	1	1004659	4014486718737
	87664231	1	No AP	
	87664231	1	No AP	
	87671290	1	1004718	4014486716672
	87671291	2	1004717	4014486716689
	87671748	1	1004532	4014486718379
	87671939	1	1004889	4014486717549
	87673234	1	1004373	4014486714180
	87683178	1	1004115	4014486522907
	87699094	1	1003941	4014486481563
	87721960	1	No AP	
	87721960	1	No AP	
	87739437	1	1002811	4014486462920
	87741240	1	1001914	4014486489774
	87747431	1	1001876	4014486489231
	87755884	1	1003195	4014486481884
	87758085	1	1004376	4014486714210
	87800129	1	1002569	4014486495331
	89505865	1	1001654	4014486486070
	89506463	1	1001690	4014486486643
	89507997	1	1000271	4014486464399





## CASE INTL. HARVESTER

	89509459	1	1000163	4014486461855
	89510091	1	1003431	4014486464313
	89513440	8	1002138	4014486476514
	89515166	3	1002120	4014486476224
	89515167	3	1002865	4014486520224
	89515172	2	1000546	4014486468328
	89515713	3	1002825	4014486464474
	89516212	1	1001206	4014486519150
	89811480	1	1003616	4014486486667
	89811963	1	1001695	4014486486711
	89813594	1	1000399	4014486466621
	89817249	1	No AP	
	89817439	1	1000593	4014486469202
	89817548	1	1000739	4014486471342
	89819506	1	1001693	4014486486698
	89819507	1	1001699	4014486486759
	89819509	1	1001692	4014486486674
	89831571	1	1003668	4014486491333
	89831693	1	1002445	4014486493245
	89831694	1	1002448	4014486493283
	89831695	1	1002449	4014486493290
	89831696	1	1002450	4014486493306
	89831697	1	1002454	4014486493368
	89831698	1	1002452	4014486493337
	89831699	1	1002456	4014486493399
	89831700	1	1002457	4014486493405
	89831701	1	1002460	4014486493436
	89831702	1	1002462	4014486493467
	89831703	1	1002465	4014486493504
	89831704	1	1002468	4014486493542
	89831705	1	1002471	4014486493573
	89831706	1	1002473	4014486493597
	89831707	1	1002475	4014486493627
	89831708	1	1002478	4014486493696
	89831709	1	1002933	4014486493757
	89831710	1	1002483	4014486493801
	89831711	1	1002920	4014486493849
	89831712	1	1002922	4014486493887
	89831713	1	1002488	4014486493900
	89831714	1	1002490	4014486493931
	89831715	1	1002492	4014486493955
	89831716	1	1002494	4014486493986
	89831717	1	1002495	4014486494006
	89831718	1	1002496	4014486494013
	89831719	1	1002497	4014486494020
	89831720	1	1002499	4014486494051
	89831721	1	1002461	4014486493450
	89831722	1	1002505	4014486494105
	89831723	1	1002507	4014486494129
	89831724	1	1002508	4014486494143
	89831725	1	1002512	4014486494204
	89831726	1	1002514	4014486494266
	89831727	1	1002515	4014486494297
	89831728	1	1002521	4014486494389
	89831729	1	1002534	4014486494556



## CASE INTL. HARVESTER

	89831730	1	1002537	4014486494600
	89831731	1	1002539	4014486494648
	89831732	1	1002543	4014486494723
	89831733	1	1002547	4014486494778
	89831734	1	1002549	4014486494815
	89831735	1	1002551	4014486494846
	89831736	1	1002554	4014486494914
	89831737	1	1002556	4014486494983
	89831738	1	1002558	4014486495034
	89831739	1	1002560	4014486495102
	89831740	1	1002562	4014486495157
	89831741	1	1002567	4014486495270
	89831742	1	1002571	4014486495379
	89831743	1	1002575	4014486495478
	89831744	1	1002579	4014486495560
	89831745	1	1002582	4014486495638
	89831746	1	1002584	4014486495706
	89831747	1	1002588	4014486495812
	89831748	1	1002593	4014486495904
	89831749	1	1002594	4014486495942
	89831750	1	1002595	4014486495980
	89831751	1	1002598	4014486496031
	89831752	1	1002599	4014486496055
	89833888	1	1004470	4014486712179
	89835010	1	1000726	4014486471182
	89835047	1	1000827	4014486472547
	89850532	1	1002147	4014486476613
	99466943	2	1004256	4014486494952
	99466947	1	1002555	4014486494945
	209553078	1	1002124	4014486476279
	340433153	1	1000127	4014486461411
	419375000	2	1002773	4014486465891
	500380059	1	1003718	4014486519365
	500386112	2	1004256	4014486494952
	700707578	1	No AP	
	700707586	1	No AP	
	700711518	1	No AP	
	770000722	1	1001629	4014486485714
	770000980	1	1001894	4014486489538
	770001008	1	1001742	4014486487268
	770002330	1	1001721	4014486487039
	842373502	1	1003200	4014486481952
	873541380	1	1003171	4014486481488
	873541410	1	1004851	4014486716542
	873735690	1	1002530	4014486494495
	875556830	1	1004157	4014486523362
	4031832698	1	1003947	4014486497632
	4032804396	1	1003948	4014486497649
	4032807784	1	1003949	4014486490152
	4032808262	1	1001828	4014486488494
	4131775305	1	1001202	4014486497588
	4131775313	2	1002213	4014486477641
	4131781055	1	1001557	4014486484564
	4131781578	2	1003036	4014486477733
	4131781578	2	1003036	4014486477733



## CASE INTL. HARVESTER

	4221613143	1	1003560	4014486473391
	4221668157	1	No AP	
	4221668181	1	1001204	4014486497618
	4240053761	2	1003006	4014486476255
	4247047693	1	1000000	4014486458961
	4250121764	1	1003650	4014486489354
	4250121860	1	1000998	4014486520460
	4250121877	1	1001202	4014486497588
	4250121885	1	1001205	4014486497625
	4250129730	2	1002238	4014486478037
	4250129747	1	1003314	4014486477832
	4250129755	1	1003687	4014486477870
	4254138496	2	1002349	4014486478822
	4254138824	1	1003685	4014486477719
	4254138832	1	1002185	4014486477290
	4254138840	1	1002161	4014486476811
	4254138857	1	1002124	4014486476279
	4255643332	1	1000623	4014486469684
	4260699985	1	1001901	4014486489613
	4260699993	1	1001516	4014486460353
	4260700007	1	1002166	4014486476910
	4260700015	1	1002135	4014486476477
	4260700015	1	1002135	4014486476477
	4260700023	2	1003007	4014486476941
	4260700031	2	1002990	4014486475968
	4260700031	2	1002990	4014486475968
	4260703838	1	1002280	4014486478488
	4260703846	1	1002263	4014486478303
	4260703926	1	1003563	4014486473520
	4260703926	1	1003563	4014486473520
	4264715364	1	1000634	4014486469875
	4270717737	1	1001944	4014486490442
	4270717737	1	1001944	4014486490442
	4270717737	1	1001944	4014486490442
	4270722236	1	1003361	4014486485752
	4270722244	1	1001513	4014486460322
	4270722252	1	1002400	4014486479416
	4270722252	1	1002400	4014486479416
	4270722517	2	1003052	4014486479423
	4270722517	2	1003052	4014486479423
	9351017400	1	1001630	4014486485738
	9911860435	1	1000906	4014486473537
	9911860628	2	1002881	4014486469554
	9911860958	1	1001178	4014486497502
	9911861364	1	No AP	
	9911861477	1	1002065	4014486475456
	9911861477	1	1002065	4014486475456
	9911861493	1	1002127	4014486476309
	9911861516	1	1002216	4014486477689
	9911861524	1	1002218	4014486477726
	9911861540	1	1002223	4014486477795
	9911861612	1	1002148	4014486476637
	9911861717	2	1003009	4014486476088
	9911861725	1	1002110	4014486476071
	9911861862	1	1002237	4014486478013

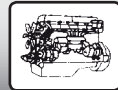

## CASE INTL. HARVESTER

	9911861901	1	1002228	4014486477887
	9911861918	2	1002991	4014486475463
	9911861926	2	1003689	4014486478020
	9911862043	2	1002992	4014486475630
	9911862043	2	1002992	4014486475630
	14010060002	1	1003695	4014486493634
	51102171670	1	1001556	4014486484557
	51102174610	1	1001678	4014486486476
	51651131427	1	1003373	4014486461282
	51651132765	1	1000156	4014486461787
	51651170965	1	1003383	4014486462241
	51651170975	1	1003384	4014486462272
	51651171700	1	1000243	4014486463613
	51651171930	1	1003426	4014486464092
	51651172413	1	1000300	4014486464979
	51651173861	1	1000377	4014486466409
	51651221725	1	1000561	4014486468601
	51651221981	1	1000584	4014486469028
	51651222413	1	1000620	4014486469608
	51651222650	1	1003525	4014486470024
	51651222800	1	1000659	4014486470239
	51651223505	1	1000721	4014486471137
	51651255246	1	1000927	4014486473773
	51651321480	1	1001408	4014486459159
	51651453200	1	1001490	4014486460001
	51651502130	1	1001508	4014486460247
	51652131450	1	1000120	4014486461312
	51652171372	1	1003336	4014486462845
	51652171800	1	1001560	4014486484595
	51652172200	1	1001585	4014486484953
	51652172500	1	1001602	4014486485240
	51652174225	1	1001668	4014486486315
	51652174350	1	1003614	4014486486414
	51652175000	1	1001690	4014486486643
	51653173180	1	1001859	4014486488944
	51653173762	1	1003649	4014486489323
	51654172420	1	1001956	4014486490633
	3228287 R91	2	1002945	4014486495492
	J911587	1	No AP	
	003795185	1	No AP	
	00422731	1	1000696	4014486470772
	00921330	1	1000785	4014486472011
	01100788	1	1002052	4014486475296
	01101723	1	1000243	4014486463613
	01101811	1	1001579	4014486484861
	01101908	3	No AP	
	01103493	2	No AP	
	01103821	2	1002826	4014486462616
	01104002	1	1003400	4014486462906
	01108473	1	1003498	4014486468953
	01108520	1	1003503	4014486469103
	01109023	1	1002322	4014486480108
	01109080	1	1002406	4014486479508
	01109312	1	No AP	
	01111067	1	1002039	4014486475142

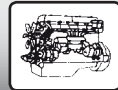

## CASE INTL. HARVESTER

	01111227	1	1002219	4014486477740
	01111661	1	1002391	4014486479324
	01111678	1	1003693	4014486479294
	01111717	1	1002396	4014486479379
	01111725	1	1002161	4014486476811
	01111766	1	1000179	4014486462081
	01111887	2	1002213	4014486477641
	01111895	2	1003036	4014486477733
	01111895	2	1003036	4014486477733
	01112277	3	1003039	4014486477801
	01112605	4	1003011	4014486477245
	01113116	1	1001626	4014486485653
	01113501	1	1001570	4014486484731
	01113550	1	1002153	4014486476712
	01113864	1	1002166	4014486476910
	01113872	1	1000179	4014486462081
	01113880	1	1004083	4014486476972
	01113897	1	1000178	4014486462074
	01113928	1	1002344	4014486478778
	01113950	3	1002123	4014486476262
	011170198	1	1003611	4014486486230
	01145629	4	1004102	4014486520743
	01169686	5	1002209	4014486477603
	01169694	1	1002191	4014486477382
	01170132	1	1001639	4014486485905
	020476355	1	1002148	4014486476637
	020953053	1	1002185	4014486477290
	020953061	1	1002161	4014486476811
	021189838	1	1000634	4014486469875
	021206287	1	1002143	4014486476552
	021206287	1	1002143	4014486476552
	021365202	1	1003609	4014486485899
	04-113516	1	1003577	4014486492347
	04-113518	1	1001256	4014486492132
	04-113598	1	1001946	4014486490480
	04-113598	1	1001946	4014486490480
	04-114742	1	1003579	4014486492743
	04-119434	1	1002025	4014486491609
	04-119434	1	1002025	4014486491609
	04-122838	1	1001255	4014486492125
	04-133180	1	1001232	4014486491869
	060007646	2	1003007	4014486476941
	060038666	1	1002280	4014486478488
	060067605	1	1001649	4014486486018
	060067638	1	1002135	4014486476477
	060067646	2	1003780	4014486476934
	060067654	2	1002990	4014486475968
	060143490	1	1002198	4014486477481
	060143505	2	1003003	4014486476415
	060178276	1	1001622	4014486485554
	060178276	1	1001622	4014486485554
	060187034	1	1002257	4014486478242
	060187034	1	1002257	4014486478242
	060187276	1	1001622	4014486485554
	060187284	1	1000714	4014486471045

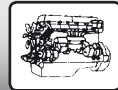

## CASE INTL. HARVESTER

	060187284	1	1000714	4014486471045
	060190778	1	1000688	4014486470680
	060190778	1	1000688	4014486470680
	060190786	1	1000637	4014486469943
	060191762	2	1003671	4014486475395
	060206963	2	1004750	4014486719147
	060206971	2	1002993	4014486475548
	060206971	2	1002993	4014486475548
	060206988	1	1000041	4014486460780
	060206988	1	1000041	4014486460780
	060500044	2	1002747	4014486461015
	060500108	2	1002347	4014486478808
	060500116	2	1002352	4014486478853
	060506933	2	1002409	4014486479539
	060519150	1	1001676	4014486486421
	061009082	1	1002202	4014486477528
	061009082	1	1002202	4014486477528
	061009396	3	1003010	4014486519143
	061009396	3	1003010	4014486519143
	061009402	2	1003005	4014486476729
	061009402	2	1003005	4014486476729
	061015851	2	1003012	4014486476569
	061017105	1	1002282	4014486478501
	061017105	1	1002282	4014486478501
	061020986	1	1001647	4014486485998
	061020986	1	1001647	4014486485998
	061029584	1	1002264	4014486478310
	061029584	1	1002264	4014486478310
	061033443	1	1002151	4014486476699
	061036454	1	1001628	4014486485684
	061036454	1	1001628	4014486485684
	061067790	2	1000371	4014486466348
	061068951	1	1001659	4014486486155
	061068976	2	1003003	4014486476415
	061068984	2	1002390	4014486479317
	061068992	2	1003051	4014486479300
	061069028	1	1002201	4014486477511
	061069036	1	1002389	4014486479287
	0616355	1	1000662	4014486470260
	082.383/28	1	1002560	4014486495102
	082.383/42	2	1002961	4014486495058
	10VX00C	1	1004025	4014486519099
	1113096X1	1	1001771	4014486487565
	1113097C2	1	1001144	4014486490077
	130100060017	1	1003696	4014486493689
	130100060018	2	1002936	4014486493719
	1301000600181	2	1003769	4014486493702
	130100130041	1	1002551	4014486494846
	1301001300411	1	1002551	4014486494846
	130100130071	1	1002560	4014486495102
	130100130072	1	1002595	4014486495980
	130100130112	1	1002575	4014486495478
	130100130113	1	1002598	4014486496031
	130300060002	1	1003714	4014486494853
	1303000600021	1	1003715	4014486494839

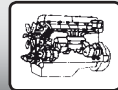

## CASE INTL. HARVESTER

	130800060010	1	1002471	4014486493573
	1316573C2	1	No AP	
	132000060012	1	1002572	4014486495416
	1320000600121	1	1002572	4014486495416
	132000130020	1	1003699	4014486494211
	1320001300201	4	1003777	4014486494235
	132000130021	1	1002560	4014486495102
	1320001300211	1	1003726	4014486495096
	1321564C1	1	1002316	4014486480047
	1325050C1	1	1000748	4014486471458
	1329161C1	1	No AP	
	1330311C1	1	1000247	4014486463750
	1374-310-379	1	1001408	4014486459159
	1374-310-380	1	1001490	4014486460001
	1374-310-381	1	1001408	4014486459159
	1374-310-400	1	1000220	4014486462838
	1374-310-401	2	1004834	4014486714852
	1374-310-403	1	1000931	4014486473810
	1374-310-407	1	1001811	4014486488234
	1374-310-418	2	1004360	4014486714043
	1374-310-420	1	1001413	4014486459203
	1374-310-421	1	1001508	4014486460247
	1374-310-425	1	1000615	4014486469530
	1374-390-129	1	1003615	4014486486490
	1374-390-157	1	1001840	4014486488661
	1374-390-255	1	1004428	4014486715279
	1374-390-275	1	1004488	4014486715873
	139900130003	1	1002567	4014486495270
	1399001300031	1	1002567	4014486495270
	139900270174	2	1000030	4014486483529
	139900270236	2	1001172	4014486497342
	139900270270	2	1000076	4014486483970
	139900270408	1	1002074	4014486475623
	139900270478	2	1001218	4014486497519
	140100060001	1	1002475	4014486493627
	140100060002	2	1002924	4014486493658
	1401000600021	2	1003768	4014486493641
	140100130131	1	1003745	4014486495959
	1401001301311	1	1003745	4014486495959
	1401001301321	1	1003728	4014486495140
	1411000600141	1	1002478	4014486493696
	1413C060017	1	1000068	4014486483888
	142000060001	2	1002973	4014486495188
	1420000600011	2	1003775	4014486495171
	142000060011	2	1002977	4014486495218
	1420000600111	1	1002564	4014486495201
	142000060012	2	1002980	4014486495348
	1420000600121	1	1002569	4014486495331
	142000130004	1	1003704	4014486494396
	1420001300041	1	1003704	4014486494396
	142000130005	1	1003705	4014486494457
	1420001300051	1	1003705	4014486494457
	159639A1	1	1004802	4014486720457
	1609B130009	1	1000015	4014486483321
	161200090098	1	1003364	4014486483406



## CASE INTL. HARVESTER

	16131DA	1	1000533	4014486468137
	162000060001	1	1003733	4014486495386
	1620000600011	2	1003774	4014486495393
	1620000600005	1	1003734	4014486495485
	1620000600051	1	1003734	4014486495485
	1620000600006	1	1002569	4014486495331
	1620000600061	1	1002569	4014486495331
	1620000600007	1	1003739	4014486495645
	1620000600007(1)	1	1003739	4014486495645
	1620000600071	1	1003739	4014486495645
	162000130003	1	1003736	4014486495577
	1620001300031	1	1003737	4014486495553
	162000130004	1	1003701	4014486494273
	1620001300041	1	1003701	4014486494273
	162000130007	1	1003703	4014486494303
	1620001300071	1	1003703	4014486494303
	162000130046	1	1002513	4014486494242
	1620001300461	1	1002513	4014486494242
	1620001300741	1	1004773	4014486716559
	162000131001	1	1002521	4014486494389
	178019R1	1	1000625	4014486469738
	1806189C1	1	1002529	4014486494488
	181055C11	1	1001374	4014486474886
	182819C1	1	1000742	4014486471380
	188213C3	1	1000692	4014486470710
	190003140006	1	1002547	4014486494778
	190003140007	1	1002475	4014486493627
	190003140013	1	1002483	4014486493801
	190003140020	1	1002594	4014486495942
	190003140029	1	1002453	4014486493351
	190003140030	1	1002451	4014486493313
	190003140032	2	1002924	4014486493658
	190003140035	4	1002979	4014486494228
	190003140037	1	1000062	4014486483826
	190003140039	4	1002981	4014486494167
	190003140041	1	1002478	4014486493696
	190003140047	1	1002554	4014486494914
	190003140053	2	1002944	4014486495294
	190003140054	1	1002442	4014486493207
	190003140062	1	1002556	4014486494983
	190003140064	3	1002982	4014486494679
	190003140073	1	1002529	4014486494488
	190003140078	1	1002512	4014486494204
	190003140079	1	1003365	4014486483437
	190003140080	1	1000185	4014486462142
	190003140081	1	1000051	4014486483710
	190003140083	2	1002983	4014486494860
	190003140084	1	1002514	4014486494266
	190003141018	1	1000023	4014486483444
	190003142270	2	1002937	4014486493238
	190003142272	2	1002938	4014486493276
	190003142273	2	1002939	4014486493320
	190003142275	1	1002447	4014486493269
	190003142278	1	1002443	4014486493214
	190003142284	1	1000007	4014486483246



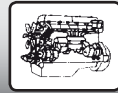

## CASE INTL. HARVESTER

	190003142287	1	1000008	4014486483253
	190003142290	1	1003321	4014486483215
	190003142291	1	1000011	4014486483284
	190003142293	1	1000009	4014486483260
	190003142295	1	1000013	4014486483307
	190003142304	1	1000006	4014486483222
	190003142309	1	1003362	4014486483369
	190003142313	1	1000025	4014486483468
	190003142325	2	1002742	4014486483499
	190003142332	1	1000012	4014486483291
	190003142334	2	1000028	4014486483505
	190003142340	2	1002481	4014486493764
	190003142350	2	1002918	4014486493993
	190003142357	2	1002940	4014486493382
	190003142358	1	1002922	4014486493887
	190003142503	1	1000044	4014486483635
	190003142504	1	1000050	4014486483703
	190003142508	1	1000045	4014486483642
	190003142516	2	1000047	4014486483673
	190003142521	1	1000049	4014486483697
	190003142523	1	1002515	4014486494297
	190003142525	1	1002558	4014486495034
	190003142526	4	1002744	4014486483666
	190003142527	4	1000048	4014486483680
	190003142532	1	1000054	4014486483741
	190003142543	2	1000058	4014486483789
	190003142557	1	1000065	4014486483857
	190003142558	1	1000067	4014486483871
	190003142590	3	1002984	4014486494136
	190003142710	1	1000194	4014486462289
	190003142718	1	1000206	4014486462463
	190003142802	1	1000492	4014486467642
	190003143470	1	1000017	4014486483345
	190003149999	1	1002343	4014486478761
	194528C2	1	1003471	4014486519754
	1970116C2	1	1000625	4014486469738
	1979606C2	1	1003342	4014486462982
	244420A3	1	1001531	4014486460506
	244420A4	1	1004746	4014486720341
	244422A3	1	1001532	4014486460513
	244422A4	1	1004747	4014486720358
	244423A3	1	1001534	4014486460537
	244423A4	1	1004748	4014486720365
	244423A5	1	No AP	
	247426A1	1	1004061	4014486518726
	247428A1	1	1003917	4014486518764
	288648A1	2	1003044	4014486479850
	289198A1	2	1004804	4014486720488
	289199A1	1	1004805	4014486479829
	294462A1	1	1003369	4014486461107
	299659A1	2	1002481	4014486493764
	303416R1	1	1000059	4014486483796
	3043167R1	1	1002571	4014486495379
	3050382R1	1	1000023	4014486483444
	3055525R1	1	1002560	4014486495102



## CASE INTL. HARVESTER

	3055526R1	1	1000072	4014486483925
	3055715R91	1	1002556	4014486494983
	3060802R2	1	1000068	4014486483888
	3061786R2	1	1002314	4014486480023
	3068879R1	1	1000053	4014486483734
	3068901R1	1	1002525	4014486494433
	3069379R1	1	1000094	4014486460926
	3113342R1	1	1000072	4014486483925
	3119750R1	1	1002446	4014486493252
	31275207N1	2	1000386	4014486466492
	31275280N1	1	1002441	4014486493191
	31302068	1	1002256	4014486478235
	31310695	2	1003051	4014486479300
	3131095	2	1003051	4014486479300
	31323185	2	1000388	4014486466515
	3136257R1	1	1000062	4014486483826
	3136421R1	2	1002950	4014486495652
	3136663R1	1	1000068	4014486483888
	3139157R91	2	1002590	4014486495850
	31400010	1	1000072	4014486483925
	3142280	1	1000010	4014486483277
	3142541	1	1000055	4014486483758
	3142558	1	1000066	4014486483864
	3144098R91	2	1002975	4014486495966
	3144678R1	1	1002558	4014486495034
	3155068R1	1	1001446	4014486459548
	3156215R1	1	1001463	4014486459739
	3157009R1	1	1001478	4014486459883
	3157738R2	1	1001115	4014486496987
	3157739R1	4	1002828	4014486466270
	3158242R1	1	1001477	4014486459876
	3171057R2	1	1000130	4014486461466
	3172232R1	1	1000228	4014486463088
	3172275R1	1	1001366	4014486474800
	3172404R1	4	1000309	4014486465174
	3173726R1	1	1001889	4014486489460
	3175036R2	1	1001101	4014486496833
	3175078R1	1	1001885	4014486489415
	3175457R1	1	1003429	4014486464221
	3175578R1	3	1002094	4014486475876
	3176558R1	4	1002994	4014486476002
	3218043R1	1	1002537	4014486494600
	3218802R1	2	1000078	4014486483994
	3218951R1	1	1002560	4014486495102
	3218952R1	1	1002571	4014486495379
	3228131R1	1	1002543	4014486494723
	3228274R1	1	1002551	4014486494846
	3228279R1	1	1002547	4014486494778
	3228282R1	1	1002534	4014486494556
	3228287R1	2	1002945	4014486495492
	3228287R91	2	1002945	4014486495492
	3228641R1	2	1002956	4014486495720
	3522468M3	1	1002519	4014486494341
	358213R1	1	1000084	4014486460810
	379461A1	1	1004851	4014486716542



## CASE INTL. HARVESTER

	380041A1	1	1001143	4014486490060
	393750A1	1	1001146	4014486490107
	393751A1	1	1001144	4014486490077
	4102/50063	1	No AP	
	413159A2	1	1004749	4014486720372
	4240053712	2	1003012	4014486476569
	4240053712	2	1003012	4014486476569
	4240053712	2	1003012	4014486476569
	4250129755	1	1003687	4014486477870
	4250129755	1	1003687	4014486477870
	4254138824	1	1003685	4014486477719
	4254138824	1	1003685	4014486477719
	4254138840	1	1002161	4014486476811
	4260700015	1	1002135	4014486476477
	4990/20555	1	1001217	4014486492439
	58622R1	1	1000421	4014486466843
	600 J 04	1	1004037	4014486518580
	600A06	1	1004001	4014486518900
	600A10	1	1003994	4014486518719
	600A12	1	1003996	4014486518849
	600A701	1	1004003	4014486518931
	600A715	1	1004002	4014486518917
	600A77	1	1003997	4014486518856
	600J06	1	1004038	4014486518597
	600J09	1	1004039	4014486518801
	600P05	1	1004036	4014486518481
	600P09	1	1004035	4014486518474
	6100645M1	1	1002284	4014486479676
	6102366M1	1	1002520	4014486494358
	61521R1	1	1003416	4014486463620
	662213R1	1	1000541	4014486468236
	683548C91	2	1002303	4014486479911
	69490DA	1	1000533	4014486468137
	700714140	1	No AP	
	712216R1	1	1003370	4014486461152
	714241R1	1	1000112	4014486461183
	716404R1	1	1000024	4014486483451
	716415R1	1	1002473	4014486493597
	716417R1	1	1002478	4014486493696
	739734R1	1	1000992	4014486484328
	756232R1	1	1000086	4014486460834
	756237R1	1	1000188	4014486462173
	758866R1	1	1000110	4014486461145
	760285R1	1	1002297	4014486479843
	762861R1	1	1002265	4014486478327
	764956R1	1	1000112	4014486461183
	767564R1	1	1001001	4014486497243
	767585R91	1	1002081	4014486475715
	768220R91	1	1002081	4014486475715
	769543R91	1	1000191	4014486462210
	769830R2	1	1003539	4014486470727
	793417R2	1	1000741	4014486471373
	84766X1	1	1002521	4014486494389
	9351.0039.00	1	1003995	4014486518825
	9351.0047.00	1	1004040	4014486518832



## CASE INTL. HARVESTER

	9351.0055.00	1	1004041	4014486518863
	9351.0174.00	1	1001630	4014486485738
	9351.0179.00	1	1004007	4014486519426
	9351.0274.00	1	1001743	4014486487275
	97-018167	1	1000017	4014486483345
	98-024334	1	1001580	4014486484854
	98-024334	1	1001580	4014486484854
	98-026090	1	1001810	4014486488227
	98-026090	1	1001810	4014486488227
	98-027803	1	1001939	4014486490367
	98-028535	1	1001249	4014486492057
	98-028535	1	1001249	4014486492057
	98-029076	1	1001619	4014486485493
	98-029076	1	1001619	4014486485493
	98-029103	1	1001515	4014486460346
	98-029103	1	1001515	4014486460346
	98-031256	1	1001967	4014486490787
	98-031256	1	1001967	4014486490787
	98-032070	1	1001830	4014486488531
	98-032070	1	1001830	4014486488531
	98-036087	1	1001829	4014486488517
	98-036087	1	1001829	4014486488517
	98-036261	1	1001553	4014486484526
	98-036261	1	1001553	4014486484526
	98-039673	1	1001960	4014486490688
	98-039673	1	1001960	4014486490688
	98-039691	4	1002829	4014486462791
	98-039691	4	1002829	4014486462791
	98-039777	1	1001234	4014486491883
	98-039777	1	1001234	4014486491883
	98-039778	1	1001260	4014486492194
	98-039778	1	1001260	4014486492194
	98-039783	1	1001808	4014486488197
	98-039783	1	1001808	4014486488197
	98-039925	1	1002599	4014486496055
	98-039925	1	1002599	4014486496055
	98-041408	1	1001248	4014486492040
	98-041788	2	1001910	4014486489729
	98-042220	1	1001813	4014486488265
	98-042220	1	1001813	4014486488265
	98-042446	2	1002954	4014486495829
	98-042446	2	1002954	4014486495829
	98-043793	1	1001989	4014486491098
	98-045851	2	1002931	4014486493818
	98-045851	2	1002931	4014486493818
	98-045896	1	1001233	4014486491876
	98-045896	1	1001233	4014486491876
	98-046005	2	1002995	4014486475340
	98-046005	2	1002995	4014486475340
	98-046076	1	1002345	4014486478785
	98-046076	1	1002345	4014486478785
	98-046372	2	1002349	4014486478822
	98-046372	2	1002349	4014486478822
	9817439	1	1000593	4014486469202
	989271C1	1	1000728	4014486471205

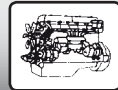

## CASE INTL. HARVESTER

	98927C	1	1000728	4014486471205
	99.060226-5000	1	No AP	
	99.060268-5000	1	1004887	4014486720389
	99.060663-1005	1	1001721	4014486487039
	99.060738-3023	1	1001883	4014486489347
	99.060739-8023	1	1001890	4014486489477
	A138759	1	1002266	4014486478334
	A184652	1	1002524	4014486494426
	A77938	1	1003140	4014486480962
	A938768	1	1002452	4014486493337
	AP706228207	4	1002097	4014486475920
	B506233	1	1001378	4014486474923
	B506234	1	1000648	4014486470093
	B506235	1	1000693	4014486470741
	B506236	1	1003406	4014486463286
	B506237	1	1003455	4014486465907
	B506238	1	1003426	4014486464092
	B506239	1	1000295	4014486464870
	B938746	2	1002487	4014486493894
	BR11018	1	1003364	4014486483406
	C338723	2	1002485	4014486493856
	C938770	2	1002996	4014486475777
	C9NN-10C318-B	1	1002565	4014486495225
	CQ13837	1	1004101	4014486469165
	DF069791	1	1001164	4014486497458
	DF070542	1	1000683	4014486470604
	DF091572	1	1000685	4014486470635
	E020T12	1	1004014	4014486519488
	E040T09	1	1004020	4014486519709
	E128625	1	1002364	4014486478983
	E84994	1	1002456	4014486493399
	G138788	2	1003043	4014486478341
	G38715	1	1003400	4014486462906
	H938752	1	1002478	4014486493696
	H938775	1	1002127	4014486476309
	J38717	1	1000203	4014486462418
	J911557	1	1002645	4014486480801
	J911559	1	1002649	4014486481020
	J911566	1	1003152	4014486481129
	J911580	1	1002657	4014486481419
	J925953	1	1003132	4014486480894
	K138722	3	1002885	4014486468670
	K311714	1	1002476	4014486493665
	K38718	1	1000118	4014486461275
	K903050	1	1002464	4014486493498
	K913631	1	1000014	4014486483314
	K938731	2	1003778	4014486476316
	K952514	1	1002422	4014486492996
	L38742	2	1002884	4014486468663
	M138747	1	1000017	4014486483345
	MGP1112	1	1000102	4014486461046
	N38744	2	1002887	4014486468526
	N938734	1	No AP	
	N938757	1	1002048	4014486475241
	ND 9050	1	1002096	4014486475890

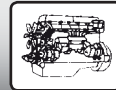
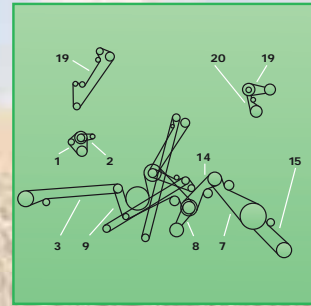
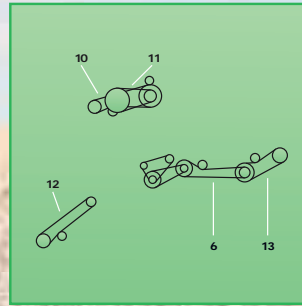
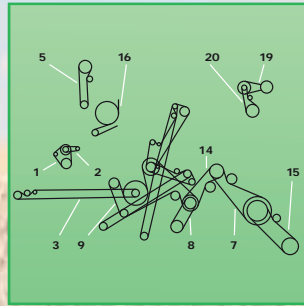
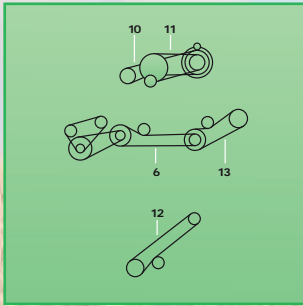

## CASE INTL. HARVESTER

		ND 9240	1	1003673	4014486475661
		ND-9003	1	1002088	4014486475807
		ND-9036	1	1003674	4014486475821
		ND-9073	1	1002095	4014486475883
		ND-9092	1	1002197	4014486477467
		ND-9317	1	1002092	4014486475852
		ND-9359	1	1003681	4014486477146
		ND-9471	1	1003680	4014486477061
		ND-9674	1	1000358	4014486466157
		P138703	1	1003397	4014486462821
		P38745	5	1002886	4014486468687
		P938712	1	1000194	4014486462289
		Q138796	1	1002044	4014486475197
		Q938713	1	1000195	4014486462296
		Q938736	2	1000056	4014486483765
		R138705	2	1002748	4014486461299
		R138797	1	1002045	4014486475210
		R938760	2	1002082	4014486475722
		S438718	1	1000050	4014486483703
		S619146	1	1001198	4014486497540
		S80928	1	1004879	4014486716580
		S938738	1	1002483	4014486493801
		S938761	1	1002362	4014486478969
		T040H02-A	1	1004016	4014486519495
		T38726	1	1000054	4014486483741
		T938762	2	1002941	4014486493344
		U 938740	1	1002462	4014486493467
		V938741	1	1002475	4014486493627
		V938764	2	1002925	4014486493795
		W938719	1	1003365	4014486483437
		W938742	1	1002482	4014486493788
		X938743	1	1002492	4014486493955
		Z938744	1	1002457	4014486493405
		Z938767	2	1003006	4014486476255

### 1400NA (from N°20715)

2	AIR CONDITIONING COMPRESSOR DRIVE	874097C1	1	1000051	4014486483710
6	UNLOADING AUGER DRIVE	191290C1	1	1000708	4014486470956
7	FEEDER DRIVE	192738C1	1	1003473	4014486519778
8	CLEANING FAN DRIVE	195396C2	1	1001417	4014486459241
9	ELEVATOR DRIVE UNIT	186509C2	1	1001379	4014486474947
10	SEPARATOR DRIVE	191241C3	1	1001142	4014486490053
14	FAN JACKSHAFT DRIVE	191305C1	1	1000654	4014486470178
20	FAN JACKSHAFT SLOW SPEED	610521R1	1	1003416	4014486463620

### 1400NA (to N°20715)

2	AIR CONDITIONING COMPRESSOR DRIVE	874097C1	1	1000051	4014486483710
6	UNLOADING AUGER DRIVE	191290C1	1	1000708	4014486470956
7	FEEDER DRIVE	192738C1	1	1003473	4014486519778
8	CLEANING FAN DRIVE	195396C2	1	1001417	4014486459241
9	ELEVATOR DRIVE UNIT	186509C2	1	1001379	4014486474947
10	SEPARATOR DRIVE	191241C3	1	1001142	4014486490053
14	FAN JACKSHAFT DRIVE	191305C1	1	1000654	4014486470178
20	FAN JACKSHAFT SLOW SPEED	610521R1	1	1003416	4014486463620

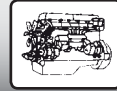
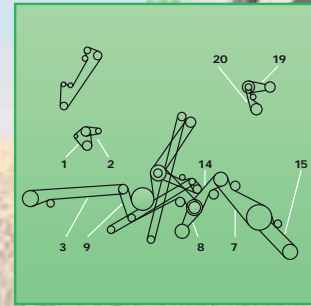
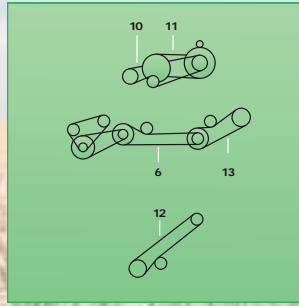
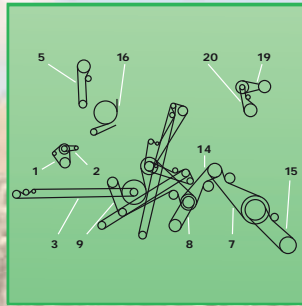
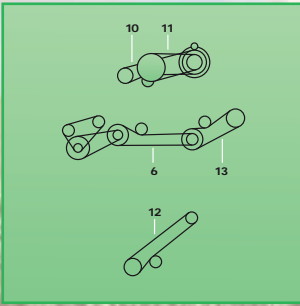

## CASE INTL. HARVESTER

### 1440E

2	AIR CONDITIONING COMPRESSOR DRIVE	874097C1	1	1000051	4014486483710
6	UNLOADING AUGER DRIVE	191290C1	1	1000708	4014486470956
7	FEEDER DRIVE	192738C1	1	1003473	4014486519778
8	CLEANING FAN DRIVE	195396C2	1	1001417	4014486459241
9	ELEVATOR DRIVE UNIT	186509C2	1	1001379	4014486474947
10	SEPARATOR DRIVE	191241C3	1	1001142	4014486490053
12	REEL DRIVE PUMP WITHOUT ROCK TRAP	197411C1	1	1000702	4014486470857
14	FAN JACKSHAFT DRIVE	191305C1	1	1000654	4014486470178
20	FAN JACKSHAFT SLOW SPEED	610521R1	1	1003416	4014486463620
	STRAW CHOPPER DRIVE	181012C1	1	1001595	4014486675481
	CLEANING UNIT DRIVE WITH STRAW CHOPPER	181055C1	1	1001374	4014486474886
	STRAW SPREADER DRIVE	196371C1	1	1000423	4014486466867

### 1460E

3	STRAW SPREADER DRIVE	196371C1	1	1000423	4014486466867
5	STRAW CHOPPER DRIVE	181012C1	1	1001595	4014486675481
6	UNLOADING AUGER DRIVE	191290C1	1	1000708	4014486470956
7	FEEDER DRIVE	192738C1	1	1003473	4014486519778
8	CLEANING FAN DRIVE	195396C2	1	1001417	4014486459241
9	ELEVATOR DRIVE UNIT	186509C2	1	1001379	4014486474947
10	SEPARATOR DRIVE	191241C3	1	1001142	4014486490053
12	REEL DRIVE PUMP WITHOUT ROCK TRAP	197411C1	1	1000702	4014486470857
14	FAN JACKSHAFT DRIVE	191305C1	1	1000654	4014486470178
16	CLEANING UNIT DRIVE WITH STRAW CHOPPER	181055C1	1	1001374	4014486474886
20	FAN JACKSHAFT SLOW SPEED	610521R1	1	1003416	4014486463620

### 1460NA (from N°23247)

2	AIR CONDITIONING COMPRESSOR DRIVE	874097C1	1	1000051	4014486483710
6	UNLOADING AUGER DRIVE	191290C1	1	1000708	4014486470956
7	FEEDER DRIVE	192738C1	1	1003473	4014486519778
8	CLEANING FAN DRIVE	195396C2	1	1001417	4014486459241
9	ELEVATOR DRIVE UNIT	186509C2	1	1001379	4014486474947
10	SEPARATOR DRIVE	191241C3	1	1001142	4014486490053
14	FAN JACKSHAFT DRIVE	191305C1	1	1000654	4014486470178
20	FAN JACKSHAFT SLOW SPEED	610521R1	1	1003416	4014486463620

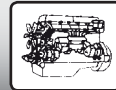
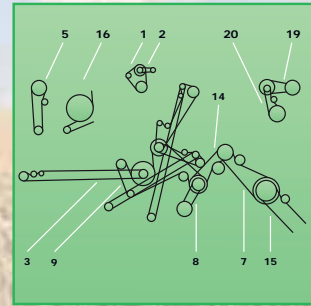
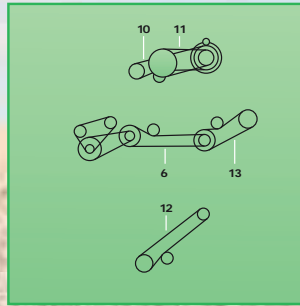
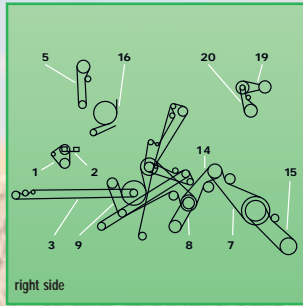
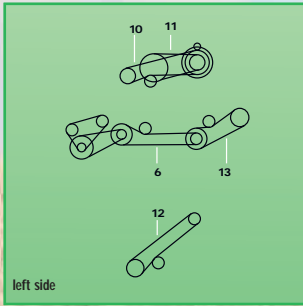

## CASE INTL. HARVESTER

### 1460NA (from N°23250)

2	AIR CONDITIONING COMPRESSOR DRIVE	874097C1	1	1000051	4014486483710
2	AIR CONDITIONING COMPRESSOR DRIVE	874097C1	1	1000051	4014486483710
3	STRAW SPREADER DRIVE	196371C1	1	1000423	4014486466867
5	STRAW CHOPPER DRIVE	181012C1	1	1001595	4014486675481
6	UNLOADING AUGER DRIVE	191290C1	1	1000708	4014486470956
7	FEEDER DRIVE	192738C1	1	1003473	4014486519778
8	CLEANING FAN DRIVE	195396C2	1	1001417	4014486459241
9	ELEVATOR DRIVE UNIT	186509C2	1	1001379	4014486474947
10	SEPARATOR DRIVE	191241C3	1	1001142	4014486490053
12	REEL DRIVE PUMP WITHOUT ROCK TRAP	197411C1	1	1000702	4014486470857
14	FAN JACKSHAFT DRIVE	191305C1	1	1000654	4014486470178
16	CLEANING UNIT DRIVE WITH STRAW CHOPPER	181055C1	1	1001374	4014486474886
20	FAN JACKSHAFT SLOW SPEED	610521R1	1	1003416	4014486463620

### 1480 (from N°24000)

2	AIR CONDITIONING COMPRESSOR DRIVE	874097C1	1	1000051	4014486483710
3	STRAW SPREADER DRIVE	196371C1	1	1000423	4014486466867
6	UNLOADING AUGER DRIVE	191291C1	1	1000723	4014486471151
8	CLEANING FAN DRIVE	195396C2	1	1001417	4014486459241
9	ELEVATOR DRIVE UNIT	186509C2	1	1001379	4014486474947
10	SEPARATOR DRIVE	191244C1	1	1001879	4014486489286
11	ROTOR VARIATOR DRIVE	244422A1	1	1001533	4014486460520
14	FAN JACKSHAFT DRIVE	188213C1	1	1000692	4014486470710
15	FEEDER JACKSHAFT DRIVE	1308489C2	1	1003573	4014486490091
16	CLEANING UNIT DRIVE WITH STRAW CHOPPER	181055C1	1	1001374	4014486474886
20	FAN JACKSHAFT SLOW SPEED	610521R1	1	1003416	4014486463620



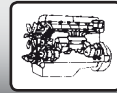
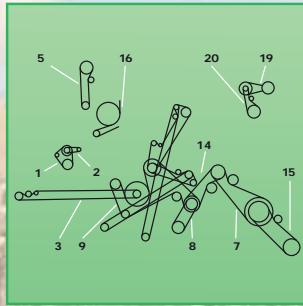
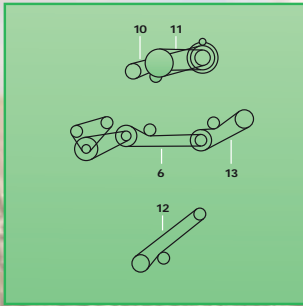

## CASE INTL. HARVESTER

### 1480NA (from N°24000)

2	AIR CONDITIONING COMPRESSOR DRIVE	874097C1	1	1000051	4014486483710
6	UNLOADING AUGER DRIVE	191291C1	1	1000723	4014486471151
8	CLEANING FAN DRIVE	195396C2	1	1001417	4014486459241
9	ELEVATOR DRIVE UNIT	186509C2	1	1001379	4014486474947
10	SEPARATOR DRIVE	191244C1	1	1001879	4014486489286
11	ROTOR VARIATOR DRIVE	244422A1	1	1001533	4014486460520
14	FAN JACKSHAFT DRIVE	188213C1	1	1000692	4014486470710
15	FEEDER JACKSHAFT DRIVE	1308489C2	1	1003573	4014486490091
20	FAN JACKSHAFT SLOW SPEED	610521R1	1	1003416	4014486463620

### 1E60NA

12	REEL DRIVE PUMP WITHOUT ROCK TRAP	197411C1	1	1000702	4014486470857
----	-----------------------------------	----------	---	---------	---------------

### 3010S

	FAN BELT	4796327	1	1002461	4014486493450
--	----------	---------	---	---------	---------------

### 3400R

	FAN BELT	4796327	1	1002461	4014486493450
--	----------	---------	---	---------	---------------

### 3550AL

	FAN BELT	4796327	1	1002461	4014486493450
--	----------	---------	---	---------	---------------

### 3550R

	FAN BELT	4796327	1	1002461	4014486493450
--	----------	---------	---	---------	---------------

### 4330V

	FAN BELT	4796327	1	1002461	4014486493450
--	----------	---------	---	---------	---------------

### 5010S

	FAN BELT	4796327	1	1002461	4014486493450
--	----------	---------	---	---------	---------------

### 8-41

	UNLOADING DRIVE	790522R1	1	1000578	4014486468939
	MAIN DRIVE	793051R2	1	1000988	4014486498097

### 8-51

	MAIN DRIVE	1408761R1	4	1000372	4014486466355
	PLATFORM DRIVE	3155127R1	1	1001091	4014486496734
	JACKSHAFT - TRACTION DRIVE	3155178R1	1	1000749	4014486471465
	HYDRAULIC PUMP DRIVE	769482R1	1	1002043	4014486475180
	RETURN ELEVATOR DRIVE	790522R1	1	1000578	4014486468939

### 8-61-321

	FEEDER AUGER - REEL VARIATOR DRIVE	1407123R1	1	1001418	4014486459258
	MAIN DRIVE	1408761R1	4	1000372	4014486466355
	RETURN AUGER - FAN DRIVE	1408840R1	1	1001369	4014486474831
	JACKSHAFT - TRACTION DRIVE	1410106R1	1	1001113	4014486496963
	JACKSHAFT - PLATFORM DRIVE	1410279R1	1	1003531	4014486470406
	PLATFORM DRIVE	3155127R1	1	1001091	4014486496734
	HYDRAULIC PUMP DRIVE	769482R1	1	1002043	4014486475180
	RETURN ELEVATOR DRIVE	790522R1	1	1000578	4014486468939

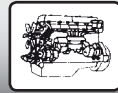

## CASE INTL. HARVESTER

### 8670A - 8970A

	BELT, 8 Ribs, Heavy Duty, From 09-01-1993	86013678	1	1004259	4014486676181
--	---	----------	---	---------	---------------

### 8-71-431

	MAIN DRIVE	1407035R1	4	1002790	4014486520057
	FEEDER AUGER - REEL VARIATOR DRIVE	1407123R1	1	1001418	4014486459258
	RETURN AUGER - FAN DRIVE	1408840R1	1	1001369	4014486474831
	JACKSHAFT - TRACTION DRIVE	1410106R1	1	1001113	4014486496963
	JACKSHAFT - PLATFORM DRIVE	1410279R1	1	1003531	4014486470406
	PLATFORM DRIVE	1410462R1	1	1001095	4014486496772
	RETURN AUGER - FAN DRIVE	3158811R1	1	1001370	4014486474848
	HYDRAULIC PUMP DRIVE	769482R1	1	1002043	4014486475180
	RETURN ELEVATOR DRIVE	790522R1	1	1000578	4014486468939

### 8-91-531

	MAIN DRIVE	1407035R1	4	1002790	4014486520057
	FEEDER AUGER - REEL VARIATOR DRIVE	1407123R1	1	1001418	4014486459258
	PLATFORM DRIVE	1410462R1	1	1001095	4014486496772
	JACKSHAFT - TRACTION DRIVE	3157094R1	1	1001117	4014486497021
	RETURN AUGER - FAN DRIVE	3157600R1	1	1001371	4014486474855
	TANK UNLOADER DRIVE	3157994R1	1	1003542	4014486470895
	JACKSHAFT - PLATFORM DRIVE	3158455R1	1	1000904	4014486473506
	RETURN ELEVATOR DRIVE	790522R1	1	1000578	4014486468939

### E 516 B

10		9911861645	1	1002076	4014486475654
----	--	------------	---	---------	---------------

### E 517

10		9911861645	1	1002076	4014486475654
----	--	------------	---	---------	---------------

### JX1070C

		4796328	2	1002942	4014486493474
--	--	---------	---	---------	---------------

### JX1075C

		4796328	2	1002942	4014486493474
--	--	---------	---	---------	---------------

### M 103

6	STRAW ELEVATOR	80230073	1	1000904	4014486473506
21	THRESHING DRUM DRIVE (MAIZE)	80230056	1	1003232	4014486518658

### SENATOR

7	SHAKER SHOE DRIVE	51101256000	1	1000931	4014486473810
---	-------------------	-------------	---	---------	---------------

### TD75D

	FAN BELT	4796327	1	1002461	4014486493450
--	----------	---------	---	---------	---------------

### TL100

	FAN BELT	4796327	1	1002461	4014486493450
--	----------	---------	---	---------	---------------





## CLAAS

2	HYDRAULIC PUMP DRIVE	767057.1	1	1003333	4014486462609
4	STRAW CHOPPER DRIVE - 1ST STAGE	667958.1	1	1003598	4014486485073
4	DISCHARGE AUGER SHAFT	673614.1	1	1001566	4014486484694
5	TRACTION DRIVE	671012.0	1	1003631	4014486488500
5	TRACTION DRIVE	671012.1	1	1003631	4014486488500
6		603337.0	1	1000662	4014486470260
7		603336.0	1	1000478	4014486467499
7		603336.1	1	1000478	4014486467499
19		673638.1	1	1001099	4014486496819
21	PRE - ACCELERATOR	661031.2	1	1001564	4014486484663
35		0628964.1	1	1002687	4014486482850
		11035850	1	1003975	4014486519334
		11035860	1	1003210	4014486482263
		11080500	1	1003256	4014486482973
		11084620	1	1003196	4014486481891
		11085260	2	1002971	4014486495423
		11085270	2	1002945	4014486495492
		11114270	1	1003159	4014486481235
		11125690	2	1004873	4014486716641
		11147900	1	1003259	4014486483024
		11147910	1	1003258	4014486483017
		11147940	1	1004156	4014486523058
		11147950	1	1004156	4014486523058
		11147960	1	1004090	4014486520521
		11147990	1	1003200	4014486481952
		11148000	1	1003198	4014486481914
		11148040	1	1003749	4014486481228
		11148050	1	1003157	4014486481198
		11171600	1	1004259	4014486676181
		11205790	1	1003194	4014486481877
		11205791	1	1002652	4014486481259
		11205800	1	1000990	4014486481792
		11408400	2	1002936	4014486493719
		11408410	2	1004713	4014486716610
		11408420	2	1002946	4014486494938
		11408430	2	1004878	4014486720624
		11408440	2	1004875	4014486719833
		11430440	2	1002944	4014486495294
		6000130460	1	1003394	4014486462692
		6000130463	1	1000115	4014486461237
		6000133192	1	1004046	4014486518382
		6000133265	1	1004827	4014486719437
		6005000475	1	1002554	4014486494914
		6005000493	1	1002552	4014486494877
		6005000844	1	1002494	4014486493986
		6005022912	1	1002410	4014486479546
		6005717341	1	1002669	4014486482072
		7700008696	2	1002936	4014486493719
		7700010200	1	1002555	4014486494945
		7700018067	2	1002944	4014486495294
		7700027207	1	1001042	4014486498127
		7700027471	1	1004725	4014486716511
		7700035746	1	1001043	4014486498134
		7700037114	1	1003744	4014486495881
		7700037116	1	1003745	4014486495959

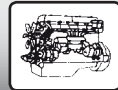

## CLAAS

	7700037231	1	1004729	4014486716757
	7700040497	1	1002735	4014486496178
	7700042687	1	1004708	4014486720655
	7700042688	1	1004707	4014486720648
	7700042689	1	1004706	4014486720631
	7700042907	1	1004728	4014486716740
	7700043664	1	1003214	4014486482355
	7700043752	1	1001334	4014486481273
	7700043753	1	1002678	4014486482201
	7700048822	1	1001335	4014486482331
	7700050644	1	1003245	4014486482805
	7700050889	1	1001336	4014486482980
	7700054412	1	1003131	4014486482683
	7700055691	1	1003146	4014486481051
	7700055692	1	1002663	4014486481839
	7700056666	1	1002537	4014486494600
	7700057145	1	1001337	4014486482652
	7700059170	1	1003134	4014486480917
	7700059172	1	1003196	4014486481891
	7700059682	1	1004726	4014486716528
	7700060521	1	1003782	4014486481037
	7700060523	1	1003190	4014486481815
	7700060527	1	1003806	4014486483031
	7700062253	1	1003135	4014486480924
	7700062256	1	1003195	4014486481884
	7700062257	1	1003192	4014486481853
	7700062268	1	1003140	4014486480962
	7700062485	1	1004689	4014486716405
	7700063621	1	1003807	4014486483048
	7700066453	1	1003217	4014486482454
	7700066699	1	1003196	4014486481891
	7700066725	1	1000990	4014486481792
	7700066735	1	1003975	4014486519334
	7700068065	1	1003235	4014486482669
	7700071570	1	1003230	4014486482621
	7700074852	1	1003975	4014486519334
	7700074853	1	1003253	4014486482904
	7700074854	1	1003797	4014486482287
	7700074855	1	1002680	4014486482249
	7701018005	1	1000053	4014486483734
	7701029701	1	1002462	4014486493467
	7701029702	1	1002465	4014486493504
	7701029703	1	1002468	4014486493542
	7701029705	1	1002474	4014486493610
	7701029707	1	1002483	4014486493801
	7701030341	1	1002464	4014486493498
	7701030342	2	1004875	4014486719833
	0055893.0	1	1004361	4014486714050
	008952.1	1	1000487	4014486467581
	0131808.0	1	No AP	
	020344.0	1	1000369	4014486466317
	020345.0	1	1001667	4014486486308
	020600.0	1	1001817	4014486488326
	020601.0	1	1000338	4014486465822
	020705.0	1	1003800	4014486518566



# CLAAS

	020706.0	1	1004418	4014486714845
	020712.0	1	1000259	4014486464115
	022985.0	1	1000394	4014486466577
	023218.0	1	1003629	4014486488258
	023219.0	1	1000772	4014486471809
	023220.1	1	1000650	4014486470123
	023999.0	1	1004412	4014486714760
	024664.0	1	1004852	4014486718300
	025242.0	1	1002717	4014486488203
	027070.0	1	1004427	4014486714982
	027275.0	1	1001209	4014486497687
	027279.0	1	1003835	4014486463835
	027280.0	1	1000237	4014486463408
	027284.0	1	1004434	4014486715330
	027286.0	1	1004265	4014486682915
	027287.0	1	1004439	4014486715385
	027322.0	1	1004858	4014486717679
	027323.0	1	1004839	4014486714944
	027324.0	1	1004529	4014486718348
	027327.0	1	1004857	4014486717655
	027508.0	1	1004737	4014486719086
	027547.0	1	1000232	4014486463262
	027581.0	1	1001720	4014486487022
	034628.0	1	1004656	4014486718874
	0480477.0	3	1004891	4014486714807
	050090.0	1	1000528	4014486468083
	050154.1	1	No AP	
	051689.0	1	1000368	4014486466300
	0545307.0	2	1002869	4014486471663
	0549238.0	1	1004253	4014486675986
	055292.0	1	1000240	4014486463484
	0554171.0	1	1004087	4014486520354
	0554186.0	1	1004087	4014486520354
	055772.0	1	1000352	4014486466096
	060162.0	1	1000481	4014486467529
	060239.1	1	1000484	4014486467550
	060304.1	1	1002250	4014486478174
	060305.0	1	1002249	4014486478167
	060306.4	1	1000723	4014486471151
	060307.0	1	1004487	4014486721430
	060916.0	1	1002253	4014486478204
	060954.0	1	1000865	4014486473032
	061088.0	1	1004446	4014486715477
	061204.0	1	1000884	4014486473247
	061252.0	1	1000875	4014486473155
	061253.1	1	1000873	4014486473131
	061704.0	1	No AP	
	0617309.0	2	1000953	4014486474084
	0617309.1	2	1000954	4014486474091
	0617309.2	2	1000954	4014486474091
	064874.0	1	1000568	4014486468755
	0660504.0	1	1001939	4014486490367
	068752.0	1	1000369	4014486466317
	068752.1	1	1000369	4014486466317
	068786.0	1	1000362	4014486466218

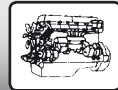

## CLAAS

	069925.0	1	1000285	4014486464665
	070052.0	1	1003393	4014486462661
	076401.0	1	1001324	4014486492866
	076401.1	1	1001324	4014486492866
	077401.0	1	1000283	4014486464610
	081648.0	1	1001326	4014486492903
	083615.0	1	1001330	4014486492941
	083668.0	1	1001329	4014486492934
	083668.1	1	1001329	4014486492934
	0854277500	1	1004830	4014486713954
	090255.0	1	1001293	4014486492453
	090256.0	1	1001295	4014486492477
	090256.1	1	1001296	4014486492484
	090265.0	1	No AP	
	090266.0	1	No AP	
	090267.0	1	No AP	
	090286.0	1	No AP	
	094046.1	2	1002777	4014486463064
	094046.2	2	1002777	4014486463064
	094047.0	1	1000092	4014486460902
	103037.0	1	1002135	4014486476477
	103735.0	1	1002382	4014486479188
	104098.1	1	1003675	4014486475944
	104237.1	4	1003002	4014486477092
	104497.0	1	1003682	4014486477207
	104914.0	1	1003491	4014486468458
	104990.0	1	1000561	4014486468601
	105580.0	1	1002382	4014486479188
	105603.0	1	1002377	4014486479126
	105660.0	1	1002719	4014486476132
	105860.0	1	1003442	4014486465082
	105860.1	1	1003442	4014486465082
	12260820.0	1	1000488	4014486467598
	12316790.0	1	1004351	4014486713947
	124205.0	1	No AP	
	124215.0	1	No AP	
	124225.0	1	No AP	
	124231.0	1	No AP	
	124232.0	1	No AP	
	124233.0	1	No AP	
	124235.0	1	No AP	
	130901.0	1	No AP	
	130906.0	1	1004866	4014486718782
	130931.0	1	1003800	4014486518566
	130934.0	1	No AP	
	130998.0	1	No AP	
	130999.0	1	No AP	
	131801.0	1	No AP	
	131802.0	1	No AP	
	131803.0	1	No AP	
	131995.0	1	No AP	
	131996.0	1	No AP	
	131997.0	1	No AP	
	131998.0	1	No AP	
	131999.0	1	No AP	

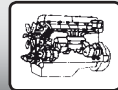

# CLAAS

	1320324.0	1	1004830	4014486713954
	1320382.0	3	1004411	4014486714777
	1320434.0	4	1004401	4014486714678
	1320628.0	4	1004393	4014486714593
	1324222.0	1	No AP	
	140755.0	1	1004636	4014486718560
	140756.0	1	1004679	4014486719741
	140765.0	1	No AP	
	142845.1	1	1004866	4014486718782
	144298.0	1	1004874	4014486716481
	144298.1	1	1004874	4014486716481
	144299.0	1	1004699	4014486716467
	144356.0	1	No AP	
	144361.0	1	No AP	
	144550.0	1	1004676	4014486719789
	144551.0	1	1004677	4014486719796
	144898.0	1	1004839	4014486714944
	145265.0	1	1002053	4014486475302
	146890.0	1	1000097	4014486460964
	147217.0	1	1002549	4014486494815
	147218.1	2	1004711	4014486716603
	147220.0	1	1004886	4014486719161
	147232.1	2	1003770	4014486495300
	176432.0	1	1001685	4014486486605
	176432.1	1	1001685	4014486486605
	176432.2	1	1001685	4014486486605
	176440.0	1	1001636	4014486485844
	176440.1	1	1001636	4014486485844
	176474.0	1	1001236	4014486491906
	176474.1	1	1001236	4014486491906
	176475.0	1	1001289	4014486520545
	176542.0	1	1001936	4014486490336
	176542.1	1	1001936	4014486490336
	176544.0	1	1002299	4014486479874
	177432.3	1	1004524	4014486718317
	181501.0	1	1001873	4014486489163
	211240.0	2	1001059	4014486522754
	212759.0	1	1000801	4014486472202
	213589.0	1	1000158	4014486461800
	214243.0	1	1004821	4014486719406
	2150142.0	1	1002676	4014486482188
	2150670.0	1	1003131	4014486482683
	2158659.0	1	1003214	4014486482355
	2158661.0	1	1002683	4014486482430
	2158663.0	1	1003220	4014486482478
	2210757.0	1	1004504	4014486717082
	2227544.0	1	1004522	4014486717280
	2227556.0	1	1004407	4014486714739
	2227586.0	1	No AP	
	2227635.0	1	No AP	
	2227658.0	1	1004421	4014486714890
	233510.0	2	No AP	
	233525.0	1	1002141	4014486476538
	233943.1	3	1002786	4014486464405
	247430A1	1	1004062	4014486518757



## CLAAS

	261545.0	1	1001328	4014486492927
	310939.0	1	1002563	4014486495133
	315972.0	2	1002948	4014486495232
	316000.0	1	1000103	4014486461053
	317432.1	2	1004880	4014486716627
	319904A1	1	1004063	4014486520279
	320008.0	2	1002950	4014486495652
	324073.0	2	1003775	4014486495171
	325728.0	1	1004362	4014486461404
	326729.0	1	1004365	4014486714081
	327055.0	1	1000100	4014486461008
	349579.0	1	1004607	4014486719338
	350340.0	1	1002661	4014486481655
	350462.0	1	1001680	4014486486506
	350517.0	1	1000793	4014486472127
	352403.0	1	No AP	
	353706.0	1	1002640	4014486480566
	353706.1	1	1004868	4014486716344
	355658.0	1	1001672	4014486486360
	360007.0	1	1002510	4014486494174
	360009.0	2	1004806	4014486720495
	360011.0	1	1004702	4014486719819
	360012.0	1	1002428	4014486493054
	361787.0	2	1004630	4014486716726
	365119.0	2	1004814	4014486720556
	376830.1	1	1000269	4014486464320
	376846.0	1	1003840	4014486463903
	376855.0	1	1004457	4014486715583
	376869.0	1	1001209	4014486497687
	376894.0	1	1001852	4014486488869
	376968.0	1	1001862	4014486489019
	378330.0	1	No AP	
	428189.0	1	1004536	4014486718416
	428216.0	1	1004642	4014486718621
	428232.0	1	1004530	4014486718355
	429256.0	1	No AP	
	429272.0	3	No AP	
	429280.0	1	No AP	
	481536.0	3	1004403	4014486714692
	482122.0	3	1004408	4014486714746
	483721.0	4	1004409	4014486714753
	483935.0	3	1004399	4014486714555
	495008.0	1	1004569	4014486717341
	495067.0	1	1001618	4014486485486
	495067.1	1	1001615	4014486485455
	495431.0	2	No AP	
	500049.0	1	1000920	4014486473698
	500273.1	1	1003564	4014486473582
	500867.0	1	1003567	4014486473827
	501771.0	1	1000944	4014486473995
	501802.0	1	1003408	4014486463392
	501903.0	1	1000246	4014486463743
	503459.0	1	1000383	4014486466461
	505022.0	1	1003443	4014486465099
	505051.0	1	1004550	4014486715880





# CLAAS

	505112.0	1	1003437	4014486464818
	505113.1	1	1003461	4014486466324
	506792.1	1	1000916	4014486473650
	507278.0	1	1000959	4014486474169
	507317.0	1	1000762	4014486471632
	507317.1	3	1002868	4014486471656
	507508.0	1	1003753	4014486473445
	507626.0	1	1003548	4014486471731
	507723.0	1	1000203	4014486462418
	507908.0	1	1000204	4014486462449
	528305.0	1	1002128	4014486476330
	530142.0	2	1002944	4014486495294
	532011.1	1	1003396	4014486462784
	538714.1	1	1004398	4014486714647
	544032.0	1	1003843	4014486489880
	544114.0	1	1001846	4014486488760
	544115.0	1	1001846	4014486488760
	545174.0	1	1004526	4014486717297
	545175.0	1	1004516	4014486718263
	545176.0	2	No AP	
	545178.0	1	1001797	4014486488050
	545186.0	1	No AP	
	545187.0	1	No AP	
	545188.0	1	1004512	4014486717228
	545668.2	1	1004356	4014486714005
	548189.0	1	1004513	4014486717235
	549011.0	1	1004410	4014486717020
	549055.1	2	1003968	4014486520309
	549097.0	1	1004509	4014486717150
	549144.0	1	1004443	4014486715422
	549151.0	1	1004528	4014486718331
	549187.2	2	No AP	
	549237.0	1	No AP	
	549752.1	2	1002745	4014486460957
	549752.2	2	1002745	4014486460957
	554016.0	2	1003846	4014486472974
	554031.0	1	1004506	4014486717129
	554032.0	1	No AP	
	554087.0	1	1004508	4014486717143
	554098.1	1	1001622	4014486485554
	554110.0	1	No AP	
	554121.0	1	No AP	
	554141.0	1	No AP	
	554141.1	1	No AP	
	554150.0	1	No AP	
	554201.0	2	No AP	
	554269.0	1	1004538	4014486721362
	554279.0	1	1004539	4014486721379
	554339.0	1	No AP	
	554361.0	1	1004610	4014486717402
	554396.0	1	1004114	4014486522891
	555106.0	1	1004363	4014486714067
	560690.0	1	1000888	4014486473292
	566108.0	1	1001312	4014486492750
	567824.0	1	1001849	4014486488814



## CLAAS

	567824.1	1	No AP	
	567825.0	1	1001802	4014486488128
	568234.0	1	1002512	4014486494204
	569528.0	1	1002000	4014486491265
	570195.0	1	1003597	4014486485059
	570195.1	1	1001594	4014486485103
	570195.2	1	1004846	4014486717105
	570407.0	1	1002027	4014486491623
	570407.1	1	1002027	4014486491623
	570827.0	1	1001919	4014486489866
	570827.1	1	1001920	4014486489873
	572150.0	1	1001240	4014486491944
	573443.0	1	1000617	4014486469578
	573443.1	1	1000616	4014486469561
	577100.0	1	1002033	4014486491685
	577101.0	1	1002037	4014486491739
	577720.0	1	1001576	4014486484816
	577720.1	1	1001576	4014486484816
	577721.0	1	1001307	4014486492675
	578331.0	1	1001809	4014486488210
	578332.0	1	1001891	4014486489484
	580166.0	1	1003727	4014486495164
	596978.0	1	No AP	
	600A702	1	1004000	4014486518894
	603013.1	1	1003412	4014486463545
	603430.1	2	1000823	4014486472493
	610152.1	1	1001033	4014486496321
	610830.1	2	1002789	4014486466249
	610833.1	2	1002788	4014486466201
	617001.0	1	1000941	4014486473957
	622156.0	1	1000207	4014486462494
	622156.1	1	1000207	4014486462494
	623252.0	1	1000917	4014486473667
	623425.1	1	1004441	4014486715408
	628175.0	1	1003438	4014486464894
	628245.0	1	1004354	4014486713985
	628533.0	2	1000818	4014486472431
	628579.1	3	1000862	4014486472998
	628779.1	3	1002871	4014486473063
	628780.0	3	1000862	4014486472998
	628782.0	1	1001320	4014486492828
	628784.0	1	1001586	4014486484960
	628785.0	1	1001881	4014486489316
	628787.0	1	1001955	4014486490602
	628788.0	1	1001887	4014486489439
	628789.0	1	No AP	
	628791.0	1	1001929	4014486489996
	628847.0	1	1001214	4014486497731
	628888.0	1	1001684	4014486486551
	628981.0	1	1000431	4014486466980
	629001.1	1	1001934	4014486490305
	629110.0	1	No AP	
	629133.0	1	1001935	4014486490312
	629133.1	1	1001935	4014486490312
	629410.1	2	1002872	4014486468441



# CLAAS

	629441.1	2	1000810	4014486472332
	629445.0	1	1000209	4014486462555
	629580.0	1	1004078	4014486497878
	629580.1	1	1004078	4014486497878
	629739.0	3	1002791	4014486466164
	629739.1	3	1002791	4014486466164
	629836.1	2	1003819	4014486518870
	630011.0	1	1001129	4014486497151
	630043.1	1	No AP	
	630169.0	1	1000962	4014486474206
	633564.0	1	1004697	4014486714227
	634046.0	1	1003419	4014486463699
	638037.1	1	1001018	4014486467673
	638367.1	1	1004448	4014486715491
	639226.0	1	1000260	4014486464108
	639226.1	1	1000260	4014486464108
	639226.2	1	1000260	4014486464108
	639373.0	1	1000924	4014486473742
	639417.0	1	1003352	4014486464573
	640208.0	1	1003687	4014486477870
	644209.2	1	1004843	4014486715668
	644362.1	1	No AP	
	644368.1	2	1000858	4014486472929
	644369.1	2	1002873	4014486472851
	644391.0	1	1000802	4014486472219
	644419.1	2	1000832	4014486472585
	644509.0	1	1000718	4014486471090
	644514.0	1	1002530	4014486494495
	644891.0	1	1001573	4014486484779
	644894.0	1	1001709	4014486486872
	644895.0	1	1001875	4014486489200
	644896.0	1	1003656	4014486489958
	644897.0	1	1001870	4014486489118
	644898.0	1	1003601	4014486485219
	644899.0	1	1003540	4014486470819
	644927.0	1	1001054	4014486484410
	644928.1	1	1002439	4014486493177
	644969.0	1	1001588	4014486484991
	653380.1	1	1001032	4014486496314
	660314.0	1	1004860	4014486720860
	660314.1	1	1004860	4014486720860
	660315.0	1	1004846	4014486717105
	660382.0	1	1003254	4014486482911
	660423.0	1	No AP	
	660455.0	1	No AP	
	660464.0	1	1004666	4014486718799
	660488.0	1	1004420	4014486714883
	660506.0	1	No AP	
	660554.0	1	1004663	4014486718744
	660566.0	1	1004422	4014486714913
	660569.0	1	1004611	4014486717419
	660587.0	1	1004668	4014486718812
	660762.1	1	1004505	4014486717112
	660811.0	1	1002732	4014486461985
	660815.0	1	1004848	4014486717174

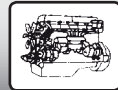

## CLAAS

	660815.1	1	1004848	4014486717174
	660821.0	1	1004567	4014486717327
	660851.1	2	1004442	4014486715415
	660854.0	1	1004380	4014486714500
	660894.0	1	No AP	
	660961.0	1	1000116	4014486461251
	660962.0	1	1004358	4014486714029
	660965.0	2	1004735	4014486719055
	661031.3	1	1001564	4014486484663
	661092.0	1	1001238	4014486491920
	661128.0	1	1000796	4014486472158
	661361.0	1	1000287	4014486464733
	661362.2	1	No AP	
	661378.0	2	1000852	4014486472820
	661378.2	2	1000852	4014486472820
	661435.0	1	1000688	4014486470680
	661458.1	1	1001957	4014486490640
	661469.0	1	1000726	4014486471182
	661541.0	1	No AP	
	664017.0	1	1004452	4014486715538
	665222.0	1	No AP	
	665798.0	2	1004485	4014486715859
	665824.0	1	1004624	4014486717563
	665825.0	1	No AP	
	665825.1	1	No AP	
	665827.1	1	No AP	
	665830.0	2	1004486	4014486715866
	665832.0	1	No AP	
	665833.0	1	No AP	
	665834.0	1	No AP	
	665865.0	1	No AP	
	665901.0	1	1004370	4014486714159
	665901.1	1	1004371	4014486714166
	665967.0	1	No AP	
	665999.0	1	1004055	4014486518412
	665999.1	1	1004055	4014486518412
	665999.2	1	1004055	4014486518412
	666290.0	1	1004468	4014486712124
	667219.0	1	1000222	4014486462876
	667245.0	1	1000413	4014486466768
	667246.0	1	1000384	4014486466478
	667248.2	1	1001317	4014486497908
	667253.0	1	1001704	4014486486810
	667254.0	1	No AP	
	667256.0	1	1001592	4014486485066
	667452.0	1	1001302	4014486492606
	667454.1	2	1002870	4014486472981
	667511.0	1	1000347	4014486466010
	667682.0	1	1003594	4014486485004
	667788.0	1	1001014	4014486487961
	667798.0	1	1000307	4014486465143
	667798.1	1	1000307	4014486465143
	667845.0	1	1000663	4014486470284
	667846.0	1	1003506	4014486469219
	667858.0	1	1001703	4014486486803

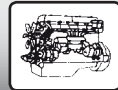

# CLAAS

	667947.1	1	1004537	4014486720853
	667981.0	1	1001589	4014486485011
	667981.1	1	1001589	4014486485011
	667993.1	2	No AP	
	668619.0	1	1002644	4014486480696
	670723.0	1	No AP	
	670724.0	1	No AP	
	670751.0	1	No AP	
	670752.0	1	1004518	4014486718287
	670768.0	1	1004353	4014486713978
	670796.0	1	1004440	4014486715392
	670835.0	1	1004113	4014486522884
	670999.0	1	1003979	4014486518405
	670999.2	1	1004795	4014486719529
	672350.1	1	1001795	4014486488029
	672359.1	1	1000477	4014486467482
	673639.1	1	1001114	4014486496970
	691381.0	1	1001278	4014486474442
	707001.1	1	1000426	4014486466898
	712386.0	1	1000001	4014486458978
	712419.0	1	1001199	4014486497557
	712419.2	1	1001199	4014486497557
	720607.0	2	1000457	4014486467260
	720607.1	2	1000457	4014486467260
	720696.1	1	No AP	
	721295.0	1	1003401	4014486463095
	722107.0	1	1002278	4014486478464
	724043.0	1	1000236	4014486463378
	724193.0	1	1000254	4014486464009
	733308.0	1	1000483	4014486467543
	733309.0	1	1000895	4014486473377
	733311.0	1	1000620	4014486469608
	733361.0	1	No AP	
	742023.0	1	1003629	4014486488258
	742024.0	2	1002876	4014486471793
	742026.1	1	1003800	4014486518566
	742027.0	4	1000297	4014486464917
	742028.0	1	1000259	4014486464115
	742030.0	1	1000673	4014486470444
	742131.1	1	1000334	4014486465747
	742143.0	1	1000394	4014486466577
	742162.0	1	1003385	4014486462302
	742182.0	1	1001340	4014486474527
	742206.0	1	1000277	4014486464511
	744833.0	1	1001961	4014486490695
	744833.1	1	1001963	4014486490725
	744874.1	1	1004797	4014486719451
	744913.0	1	1000376	4014486466393
	744963.0	1	1003845	4014486465846
	744979.0	1	1004432	4014486715316
	746505.0	1	1002272	4014486478402
	746507.0	1	1000446	4014486467130
	746508.3	1	1000266	4014486464252
	746509.0	1	1000450	4014486467178
	746550.0	1	1004788	4014486719307

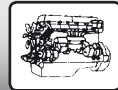

## CLAAS

	747508.0	1	1003430	4014486464245
	749701.0	1	1000167	4014486461923
	749813.0	1	1001861	4014486488975
	749817.0	1	1000436	4014486467031
	749819.0	1	1002521	4014486494389
	749824.0	1	1002438	4014486493160
	749886.0	1	1003657	4014486489989
	749914.0	1	1000720	4014486471120
	749951.0	1	1001518	4014486460377
	750192.0	1	1003464	4014486467185
	750382.0	1	1000114	4014486461220
	750382.1	1	1000114	4014486461220
	750382.2	1	1000114	4014486461220
	755070.2	2	1002795	4014486463279
	756446.0	1	1001674	4014486486391
	756474.0	1	1001078	4014486498226
	758662.1	1	1000240	4014486463484
	760869.0	1	1002648	4014486480870
	760870.0	1	1002434	4014486493122
	760870.1	1	1002434	4014486493122
	761411.1	2	1002971	4014486495423
	761412.0	1	1002567	4014486495270
	761534.0	1	1000046	4014486483659
	761979.0	1	No AP	
	768125.0	1	1000034	4014486460711
	768457.0	1	1004738	4014486719093
	769005.0	1	1001019	4014486467710
	772647.1	1	1000485	4014486467567
	781038.0	1	1001020	4014486467802
	781047.0	1	1003679	4014486473308
	781394.0	1	1003672	4014486475524
	781399.0	1	1000300	4014486464979
	781400.0	1	1003433	4014486464535
	782209.0	1	1004445	4014486715460
	783476.0	1	1004301	4014486682991
	785168.2	1	1002318	4014486480061
	785169.0	1	1000437	4014486467048
	785170.0	1	1000451	4014486467192
	785172.0	1	1000290	4014486464771
	785172.1	1	1000290	4014486464771
	785173.0	1	No AP	
	785174.1	1	1001056	4014486484434
	785175.0	1	1000594	4014486469233
	790461.0	1	No AP	
	790502.0	1	1000355	4014486466126
	791307.0	1	1001009	4014486487916
	791717.0	1	1003192	4014486481853
	796343.0	1	1001194	4014486480276
	796344.0	1	1003211	4014486482317
	796719.0	2	1002944	4014486495294
	796728.0	2	1003775	4014486495171
	798779.0	1	1003946	4014486483550
	800306.0	1	1000514	4014486467932
	801491.0	1	1000942	4014486473964
	801680.0	1	1000348	4014486466027

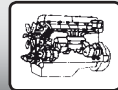

# CLAAS

	802530.0	1	1003441	4014486465020
	808761.0	1	1001347	4014486474602
	821249.0	1	1000105	4014486461084
	821813.0	1	1000102	4014486461046
	822597.0	1	No AP	
	825944.0	1	1000176	4014486462050
	827808.0	1	1004366	4014486714098
	827809.0	1	1004832	4014486714142
	829080.0	1	1002806	4014486463453
	837192.0	1	1000155	4014486461770
	837195.0	1	1003368	4014486461060
	837543.0	1	1000099	4014486460995
	837546.0	1	1000172	4014486461992
	837828.0	1	1000113	4014486461206
	838227.0	1	1003756	4014486461213
	847959.0	1	1004831	4014486714128
	854132.0	1	1000112	4014486461183
	895105.0	1	1000938	4014486473919
	901573.0	3	1002988	4014486475609
	905037.0	2	No AP	
	906561.0	1	1001300	4014486492552
	906736.0	1	1001987	4014486491074
	906736.1	1	1001987	4014486491074
	916529.1	2	1000148	4014486461671
	916532.1	1	1001893	4014486489521
	917533.0	1	1001554	4014486484533
	922188.0	3	1002799	4014486464276
	922518.0	4	1004394	4014486714609
	922519.0	4	1004392	4014486714586
	922589.0	5	1004424	4014486714951
	927323.1	1	1004456	4014486715576
	927654.0	1	1000602	4014486469349
	934301.0	1	1000254	4014486464009
	934417.2	1	1003531	4014486470406
	934418.1	1	1000684	4014486470628
	934418.2	4	1000687	4014486470659
	934862.0	4	1002765	4014486464344
	936409.0	4	1003440	4014486464924
	936718.0	3	1002800	4014486463972
	936823.1	4	1002765	4014486464344
	937031.0	3	1002801	4014486463774
	937605.0	4	1002813	4014486462319
	937997.0	3	1002804	4014486463460
	938171.0	4	1000309	4014486465174
	938171.2	5	1002803	4014486520033
	938486.0	5	1002807	4014486465266
	938931.0	4	1000322	4014486465440
	939297.0	2	1003036	4014486477733
	940490.0	4	1003011	4014486477245
	943239.0	2	1004397	4014486714654
	947112.0	4	1002812	4014486462258
	947916.0	4	1003750	4014486462326
	947916.1	4	1003750	4014486462326
	949396.0	4	1002814	4014486462722
	949668.0	3	1004423	4014486714920

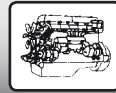
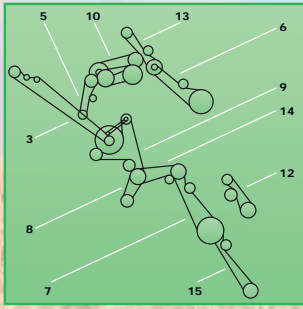

## CLAAS

		949670.0	4	1002815	4014486462227
		949888.0	4	1002772	4014486465655
		950133.0	4	1002816	4014486520040
		950327.0	1	1000314	4014486465297
		950864.0	5	1004426	4014486714975
		950890.0	1	1001931	4014486490275
		951457.0	3	1003837	4014486463316
		951654.0	4	1002813	4014486462319
		951654.1	4	1002813	4014486462319
		951655.0	3	1002818	4014486463385
		951655.1	3	1004400	4014486714661
		951889.0	1	1000281	4014486464580
		951917.0	4	1002797	4014486465457
		952578.0	1	1000288	4014486464726
		952937.0	3	1002820	4014486464450
		952937.1	3	1002820	4014486464450
		953002.8	1	1000460	4014486467291
		976299.0	3	1004404	4014486714708
		977505.1	1	1004780	4014486716917
		977506.1	1	1004771	4014486716832
		980850.0	1	1001801	4014486488098
		980851.0	1	1001829	4014486488517
		980852.0	1	1001805	4014486488166
		980852.1	1	1001805	4014486488166
		980853.0	2	1002877	4014486470499
		982376.0	2	1000644	4014486470048
		982376.1	2	1000644	4014486470048
		984885.1	1	1001810	4014486488227
		985517.0	1	1001804	4014486488142
		986390.0	1	1001942	4014486490428
		986700.1	1	1001847	4014486488777
		A0139973592	1	1004463	4014486712155
		AN1462.0	1	1001873	4014486489163
		AN6461.0	1	1004113	4014486522884
		E040T08	1	1004022	4014486519723
		V011532.0	1	1004635	4014486717976
		V209702.0	1	No AP	
		V209707.0	1	1004667	4014486718805
		V2714110	1	No AP	

## COLUMBUS

1	BALER	506880.0	1	1000901	4014486473476
1	BALER	506940.0	1	1000934	4014486473858
2	ALTERNATOR DRIVE	624131.0	1	1000194	4014486462289
2	ALTERNATOR DRIVE	750296.0	1	1000198	4014486462357
2	ALTERNATOR DRIVE	750624.0	1	1000197	4014486462340
3	KNIFE DRIVE	756051.0	1	1003508	4014486469240
3	KNIFE DRIVE	801221.0	1	1004103	4014486473315
4	TANK UNLOADER DRIVE	756059.0	1	1000889	4014486520286
5	CUTTING TABLE DRIVE	772657.0	1	1000619	4014486469592
5	CUTTING TABLE DRIVE	772657.1	1	1000619	4014486469592
6	SPREADER GRAIN IN TANK	775698.0	1	1000272	4014486464429
7	PICK UP DRIVE	800309.0	1	1003435	4014486464719
8	SHAKER SHOE FANNING MILL	506023.0	1	1000928	4014486473780
9	THRESHING MACHINE	801222.0	4	1002798	4014486465808



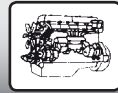
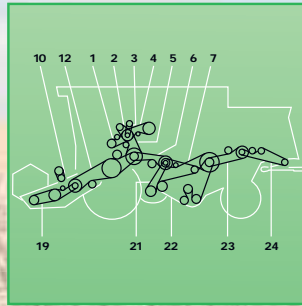
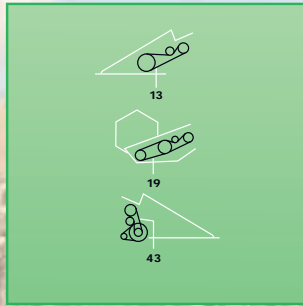
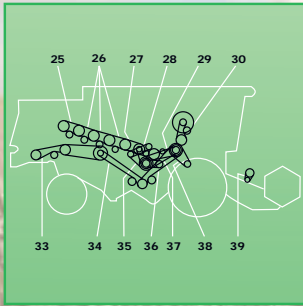

## CLAAS

10	TRACTION DRIVE	750294.0	1	1000251	4014486463897
11	TRACTION DRIVE	751112.0	1	1001161	4014486497427
12	SHAKER SHOE FANNING MILL	772658.0	1	1000935	4014486473865
12	SHAKER SHOE FANNING MILL	772660.0	1	1000936	4014486473872
13	STRAW WALKER ELEVATOR	773313.0	1	1000480	4014486467512
13	STRAW WALKER ELEVATOR	774100.0	1	1003481	4014486467963

## COMMANDOR 114

0	FOR STRAW CHOPPER	061700.1	1	1003356	4014486486131
0		603017.0	2	1000833	4014486472592
0		603017.2	2	1000833	4014486472592
1		629279.0	1	1001936	4014486490336
2		629002.0	1	1003395	4014486462715
2		629002.1	1	1003395	4014486462715
3		629908.0	1	1002332	4014486478631
3		629908.1	1	1002332	4014486478631
4		629763.0	1	1003593	4014486484977
5		629000.1	1	1003661	4014486490657
6		603337.0	1	1000662	4014486470260
7		644141.0	1	1000476	4014486467475
7		644141.1	1	1000476	4014486467475
10	TO 5.1 M CUTTING TABLE	670224.1	1	1001158	4014486497380
12		603017.3	2	1000833	4014486472592
13	FOR MAIZE PICKER	692149.0	1	1001852	4014486488869
13	FOR MAIZE PICKER	692150.0	1	1001857	4014486488920
16	FROM 6.0 M CUTTING TABLE	671013.1	1	1000676	4014486470482
19	TO 5.1 M CUTTING TABLE	713506.0	1	1000315	4014486465310
19	TO 5.1 M CUTTING TABLE	713506.1	1	1000315	4014486465310
19	TO 5.1 M CUTTING TABLE	713506.2	1	1000315	4014486465310
21		603380.0	1	1001080	4014486498240
21	BLOWER - VARIABLE SPEED DRIVE	603380.1	1	1001080	4014486498240
22		609762.0	1	1001713	4014486486919
23	FOR STRAW DISTRIBUTOR	506671.0	1	1000506	4014486467840
23	FOR STRAW DISTRIBUTOR	506671.1	1	1000506	4014486467840
23	FOR STRAW DISTRIBUTOR	506671.2	1	1000506	4014486467840
24	FOR STRAW DISTRIBUTOR	640653.1	1	1000350	4014486466065
25		644014.0	1	1002319	4014486480078
25		644014.1	1	1002319	4014486480078
26		644015.1	1	1002913	4014486484601
27		644016.0	1	1001800	4014486488104
27		644016.1	1	1001800	4014486488104
29		064168.0	1	1003635	4014486488753
29		064168.1	1	1003635	4014486488753
29		064168.2	1	1003635	4014486488753
30		233843.1	1	1000237	4014486463408
33	FOR GRAIN	061701.1	1	1000790	4014486472066
33	FOR GRAIN	061701.2	1	1000790	4014486472066
33	FOR MAIZE	061872.0	2	1002867	4014486471939
34	FOR STRAW CHOPPER	061700.0	1	1003356	4014486486131
35		603247.1	1	1003626	4014486488111
38	CYLINDER N=650-1500 RPM	628630.0	1	1001208	4014486497670
38	CYLINDER N=500-1400 RPM	644177.0	1	1001221	4014486497762
39	FROM 6.0 M CUTTING TABLE	670224.1	1	1001158	4014486497380
43		680334.0	1	1001819	4014486488364
43		680334.1	1	1001819	4014486488364



# CLAAS

## COMMANDOR 114 CS

0	FEEDER HOUSING CUTTERBAR	603017.0	2	1000833	4014486472592
0		644014.0	1	1002319	4014486480078
1	GROUND DRIVE	629279.0	1	1001936	4014486490336
2	HYDRAULIC PUMP	629002.0	1	1003395	4014486462715
2	HYDRAULIC PUMP	629002.1	1	1003395	4014486462715
3	AIR CONDITIONER	629908.0	1	1002332	4014486478631
3	AIR CONDITIONER	629908.1	1	1002332	4014486478631
4	GRAIN TANK UNLOADING	629763.0	1	1003593	4014486484977
5	INTERMEDIATE DRIVE THRESHING MECHANISM	629000.1	1	1003661	4014486490657
6	INTERMEDIATE DRIVE BLOWER	603337.0	1	1000662	4014486470260
7	INTERMEDIATE DRIVE SIEVE PAN	644141.1	1	1000476	4014486467475
10	TO 5.1 M CUTTERBAR	670224.1	1	1001158	4014486497380
12	FEEDER HOUSING CUTTERBAR	603017.2	2	1000833	4014486472592
12	FEEDER HOUSING CUTTERBAR	603017.3	2	1000833	4014486472592
13	FOR CORN PICKER	692149.0	1	1001852	4014486488869
13	FOR CORN PICKER	692150.0	1	1001857	4014486488920
16	FROM 6.0 M CUTTERBAR	671013.1	1	1000676	4014486470482
19	TO 5.1 M CUTTERBAR	713506.0	1	1000315	4014486465310
19	TO 5.1 M CUTTERBAR	713506.1	1	1000315	4014486465310
19	TO 5.1 M CUTTERBAR	713506.2	1	1000315	4014486465310
21	BLOWER - VARIABLE SPEED DRIVE	603380.1	1	1001080	4014486498240
22	SIEVE BOX	609762.0	1	1001713	4014486486919
23	INTERMEDIATE DRIVE STRAW DISTRIBUTOR	506671.0	1	1000506	4014486467840
23	INTERMEDIATE DRIVE STRAW DISTRIBUTOR	506671.1	1	1000506	4014486467840
23	INTERMEDIATE DRIVE STRAW DISTRIBUTOR	506671.2	1	1000506	4014486467840
24	FOR STRAW SPREADER	640653.1	1	1000350	4014486466065
25	8. SEPARATOR DRUM	644014.0	1	1002319	4014486480078
25	8. SEPARATOR DRUM	644014.1	1	1002319	4014486480078
26	3.5, 6.7 SEPARATOR DRUM	644015.1	1	1002913	4014486484601
27	4TH SEPARATOR DRUM	644016.1	1	1001800	4014486488104
29	INTERMEDIATE DRIVE DRUM VARIABLE SPEED	064168.0	1	1003635	4014486488753
29	INTERMEDIATE DRIVE DRUM VARIABLE SPEED	064168.1	1	1003635	4014486488753
29	INTERMEDIATE DRIVE DRUM VARIABLE SPEED	064168.2	1	1003635	4014486488753
30	TO No, 14900195	233843.1	1	1000237	4014486463408
30	ROTOR DRIVE	783430.0	1	1000238	4014486463422
30	ROTOR DRIVE	783430.1	1	1000238	4014486463422
33	CHOPPER, GRAIN	061701.1	1	1000790	4014486472066
33	CHOPPER, GRAIN	061701.2	1	1000790	4014486472066
33	CHOPPER, CORN	061872.0	2	1002867	4014486471939
34	INTERMEDIATE DRIVE II CHOPPER	061700.1	1	1003356	4014486486131
35	INTERMEDIATE DRIVE SEPARATOR DRUM	603247.1	1	1003626	4014486488111
36	INTERMEDIATE DRIVE I CHOPPER	061700.1	1	1003356	4014486486131
37	1ST AND 2ND SEPARATOR DRUM	644014.0	1	1002319	4014486480078
37	1ST AND 2ND SEPARATOR DRUM	644014.1	1	1002319	4014486480078
38	AT N 650 - 1500 MIN-1	628630.0	1	1001208	4014486497670
38	AT N 500 - 1400 MIN-1	644177.0	1	1001221	4014486497762
39	FROM 6.0 M CUTTERBAR	670224.1	1	1001158	4014486497380
42	FOR HPH - G PICKER	695610.0	1	No AP	
43	FOR HPH - G PICKER	680334.0	1	1001819	4014486488364
43	FOR HPH - G PICKER	680334.1	1	1001819	4014486488364

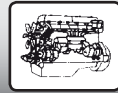
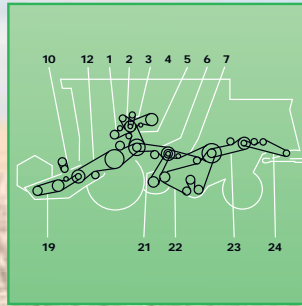
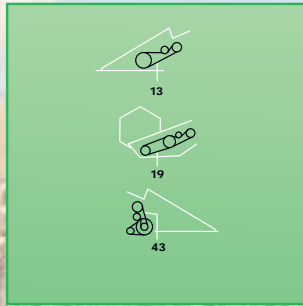
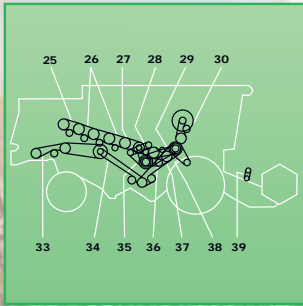

# CLAAS

## COMMANDOR 115

0	FOR STRAW CHOPPER	061700.1	1	1003356	4014486486131
0		603017.0	2	1000833	4014486472592
0		603017.2	2	1000833	4014486472592
0		644017.1	1	1001236	4014486491906
0		695610.1	1	No AP	
1		644017.0	1	1001236	4014486491906
2		629002.0	1	1003395	4014486462715
2		629002.1	1	1003395	4014486462715
3		629908.0	1	1002332	4014486478631
3		629908.1	1	1002332	4014486478631
4		629763.0	1	1003593	4014486484977
5		644018.1	1	1001243	4014486491982
6		603337.0	1	1000662	4014486470260
7		644141.0	1	1000476	4014486467475
7		644141.1	1	1000476	4014486467475
10	TO 5.1 M CUTTING TABLE	670224.1	1	1001158	4014486497380
12		603017.3	2	1000833	4014486472592
13	FOR MAIZE PICKER	692149.0	1	1001852	4014486488869
13	FOR MAIZE PICKER	692150.0	1	1001857	4014486488920
16	FROM 6.0 M CUTTING TABLE	671013.1	1	1000676	4014486470482
19	TO 5.1 M CUTTING TABLE	713506.0	1	1000315	4014486465310
19	TO 5.1 M CUTTING TABLE	713506.1	1	1000315	4014486465310
19	TO 5.1 M CUTTING TABLE	713506.2	1	1000315	4014486465310
21		603380.0	1	1001080	4014486498240
21	BLOWER - VARIABLE SPEED DRIVE	603380.1	1	1001080	4014486498240
22		609762.0	1	1001713	4014486486919
23	FOR STRAW DISTRIBUTOR	506671.0	1	1000506	4014486467840
23	FOR STRAW DISTRIBUTOR	506671.1	1	1000506	4014486467840
23	FOR STRAW DISTRIBUTOR	506671.2	1	1000506	4014486467840
24	FOR STRAW DISTRIBUTOR	640653.1	1	1000350	4014486466065
25		644014.0	1	1002319	4014486480078
25		644014.1	1	1002319	4014486480078
26		644015.1	1	1002913	4014486484601
27		644016.1	1	1001800	4014486488104
29		064168.0	1	1003635	4014486488753
29		064168.1	1	1003635	4014486488753
29		064168.2	1	1003635	4014486488753
30		233843.1	1	1000237	4014486463408
33	FOR GRAIN	061701.1	1	1000790	4014486472066
33	FOR GRAIN	061701.2	1	1000790	4014486472066
33	FOR MAIZE	061872.0	2	1002867	4014486471939
34	FOR STRAW CHOPPER	061700.0	1	1003356	4014486486131
35		603247.1	1	1003626	4014486488111
36		061700.0	1	1003356	4014486486131
38	CYLINDER N=650-1500 RPM	628630.0	1	1001208	4014486497670
38	CYLINDER N=500-1400 RPM	644177.0	1	1001221	4014486497762
39	FROM 6.0 M CUTTING TABLE	670224.1	1	1001158	4014486497380
43		680334.0	1	1001819	4014486488364
43		680334.1	1	1001819	4014486488364



# CLAAS

## COMMANDOR 115 CS

0	INTERMEDIATE DRIVE STRAW DISTRIBUTOR	506671.0	1	1000506	4014486467840
0	INTERMEDIATE DRIVE STRAW DISTRIBUTOR	506671.1	1	1000506	4014486467840
0	FEEDER HOUSING CUTTERBAR	603017.0	2	1000833	4014486472592
0		644014.0	1	1002319	4014486480078
1	GROUND DRIVE	644017.0	1	1001236	4014486491906
2	HYDRAULIC PUMP	629002.0	1	1003395	4014486462715
2	HYDRAULIC PUMP	629002.1	1	1003395	4014486462715
3	AIR CONDITIONER	629908.0	1	1002332	4014486478631
3	AIR CONDITIONER	629908.1	1	1002332	4014486478631
4	GRAIN TANK UNLOADING	629763.0	1	1003593	4014486484977
5	INTERMEDIATE DRIVE THRESHING MECHANISM	644018.1	1	1001243	4014486491982
6	INTERMEDIATE DRIVE BLOWER	603337.0	1	1000662	4014486470260
7	INTERMEDIATE DRIVE SIEVE PAN	644141.1	1	1000476	4014486467475
10	TO 5.1 M CUTTERBAR	670224.1	1	1001158	4014486497380
12	FEEDER HOUSING CUTTERBAR	603017.3	2	1000833	4014486472592
13	FOR CORN PICKER	692149.0	1	1001852	4014486488869
13	FOR CORN PICKER	692150.0	1	1001857	4014486488920
16	FROM 6.0 M CUTTERBAR	671013.1	1	1000676	4014486470482
19	TO 5.1 M CUTTERBAR	713506.0	1	1000315	4014486465310
19	TO 5.1 M CUTTERBAR	713506.1	1	1000315	4014486465310
19	TO 5.1 M CUTTERBAR	713506.2	1	1000315	4014486465310
21	BLOWER - VARIABLE SPEED DRIVE	603380.1	1	1001080	4014486498240
22	SIEVE BOX	609762.0	1	1001713	4014486486919
23	INTERMEDIATE DRIVE STRAW DISTRIBUTOR	506671.2	1	1000506	4014486467840
24	FOR STRAW SPREADER	640653.1	1	1000350	4014486466065
25	8. SEPARATOR DRUM	644014.0	1	1002319	4014486480078
25	8. SEPARATOR DRUM	644014.1	1	1002319	4014486480078
26	3.5, 6.7 SEPARATOR DRUM	644015.1	1	1002913	4014486484601
27	4TH SEPARATOR DRUM	644016.1	1	1001800	4014486488104
29	INTERMEDIATE DRIVE DRUM VARIABLE SPEED	064168.0	1	1003635	4014486488753
29	INTERMEDIATE DRIVE DRUM VARIABLE SPEED	064168.1	1	1003635	4014486488753
29	INTERMEDIATE DRIVE DRUM VARIABLE SPEED	064168.2	1	1003635	4014486488753
30	TO No, 15800110	233843.1	1	1000237	4014486463408
30	ROTOR DRIVE	783430.0	1	1000238	4014486463422
30	ROTOR DRIVE	783430.1	1	1000238	4014486463422
33	CHOPPER, GRAIN	061701.1	1	1000790	4014486472066
33	CHOPPER, GRAIN	061701.2	1	1000790	4014486472066
33	CHOPPER, CORN	061872.0	2	1002867	4014486471939
34	INTERMEDIATE DRIVE II CHOPPER	061700.1	1	1003356	4014486486131
35	INTERMEDIATE DRIVE SEPARATOR DRUM	603247.1	1	1003626	4014486488111
36	INTERMEDIATE DRIVE I CHOPPER	061700.1	1	1003356	4014486486131
37	1ST AND 2ND SEPARATOR DRUM	644014.0	1	1002319	4014486480078
37	1ST AND 2ND SEPARATOR DRUM	644014.1	1	1002319	4014486480078
38	AT N 650 - 1500 MIN-1	628630.0	1	1001208	4014486497670
38	AT N 500 - 1400 MIN-1	644177.0	1	1001221	4014486497762
39	FROM 6.0 M CUTTERBAR	670224.1	1	1001158	4014486497380
42	FOR HPH - G PICKER	695610.0	1	No AP	
42	FOR HPH - G PICKER	695610.1	1	No AP	
43	FOR HPH - G PICKER	680334.0	1	1001819	4014486488364
43	FOR HPH - G PICKER	680334.1	1	1001819	4014486488364
	FEEDER HOUSING CUTTERBAR	603017.2	2	1000833	4014486472592
	GROUND DRIVE	644017.1	1	1001236	4014486491906

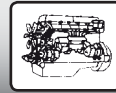
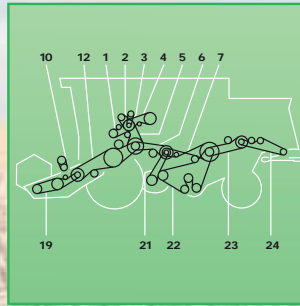
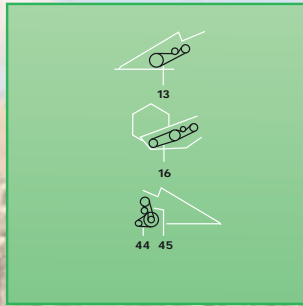
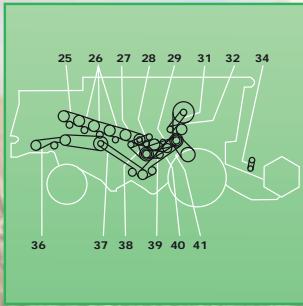

# CLAAS

## COMMANDOR 116

0	CONVEYOR SHAFT 1463 MM	603017.0	2	1000833	4014486472592
0	HYDRAULIC PUMP DRIVE (FROM NR. 15900371)	633030.0	1	1000220	4014486462838
0	ROTARY SIEVE DRIVE (TO NR. 15900150)	633030.0	1	1000220	4014486462838
1	TRAVEL DRIVE (TO NR. 15900370)	644017.0	1	1001236	4014486491906
1	TRAVEL DRIVE (TO NR. 15900370)	644017.1	1	1001236	4014486491906
1	TRAVEL DRIVE (FROM NR. 15900371)	661092.1	1	1001238	4014486491920
2	HYDRAULIC PUMP DRIVE (TO NR. 15900370)	629002.0	1	1003395	4014486462715
2	HYDRAULIC PUMP DRIVE (TO NR. 15900370)	629002.1	1	1003395	4014486462715
2	HYDRAULIC PUMP DRIVE (FROM NR. 15900371)	633030.2	1	1000220	4014486462838
3	AIR CONDITIONING COMPRESSOR DRIVE	629908.0	1	1002332	4014486478631
3	AIR CONDITIONING COMPRESSOR DRIVE	629908.1	1	1002332	4014486478631
4	TANK UNLOADING (TO NR. 15900370)	629763.0	1	1003593	4014486484977
4	TANK UNLOADING (FROM NR. 15900371)	661093.0	1	1001581	4014486484885
5	THRESHING CYLINDER (TO NR. 15900370)	644018.1	1	1001243	4014486491982
5	THRESHING CYLINDER (FROM NO. 15900371)	644403.0	1	1001247	4014486492033
6	COUNTERSHAFT - FAN DRIVE	603337.0	1	1000662	4014486470260
7	SHAKER SHOE DRIVE (TO NR. 15900370)	603336.0	1	1000478	4014486467499
7	SHAKER SHOE DRIVE (TO NR. 15900370)	603336.1	1	1000478	4014486467499
7	SHAKER SHOE DRIVE (FROM NR. 15900371)	644141.1	1	1000476	4014486467475
10	REEL DRIVE BY 5.1 M CUTTING TABLE	670224.1	1	1001158	4014486497380
12	CONVEYOR SHAFT 1463 MM	603017.3	2	1000833	4014486472592
12	CONVEYOR SHAFT 1306 MM (TO NR. 15900460)	603430.0	2	1000823	4014486472493
12	CONVEYOR SHAFT 1306 MM (FROM NR. 15900461)	644419.0	2	1000832	4014486472585
13	CUTTING TABLE DRIVE (MAIZE)	629142.0	1	1001954	4014486490596
13	FOR MAIZE PICKER	692149.0	1	1001852	4014486488869
13	FOR MAIZE PICKER HINGED	692150.0	1	1001857	4014486488920
16	CUTTING MECHANICAL FROM 6.0 M CUTTING TABLE	671013.1	1	1000676	4014486470482
19	CUTTING MECHANICAL BY 5.1 M CUTTING MECH	713506.0	1	1000315	4014486465310
19	CUTTING MECHANICAL BY 5.1 M CUTTING MECH	713506.1	1	1000315	4014486465310
19	CUTTING MECHANICAL BY 5.1 M CUTTING MECH	713506.2	1	1000315	4014486465310
21	CLEANING FAN	603380.0	1	1001080	4014486498240
22	SHAKER SHOE DRIVE	609762.0	1	1001713	4014486486919
23	FOR STRAW DISTRIBUTOR	506671.0	1	1000506	4014486467840
23	FOR STRAW DISTRIBUTOR	506671.1	1	1000506	4014486467840
23	FOR STRAW DISTRIBUTOR	506671.2	1	1000506	4014486467840
23	DISTRIBUTOR GRAIN	713506.0	1	1000315	4014486465310
23	DISTRIBUTOR GRAIN	713506.1	1	1000315	4014486465310
23	DISTRIBUTOR GRAIN	713506.2	1	1000315	4014486465310
24	STRAW DISTRIBUTOR	640653.1	1	1000350	4014486466065
25	8. SEPARATOR DRUM	644014.0	1	1002319	4014486480078
25	8. SEPARATOR DRUM	644014.1	1	1002319	4014486480078
26	SEPARATOR CYLINDER 3. 5. 6. AND 7	644015.1	1	1002913	4014486484601
27	SEPARATOR CYLINDER 4.	644016.1	1	1001800	4014486488104
28	COUNTERSHAFT - VARIATOR DRIVE	064168.0	1	1003635	4014486488753
28	COUNTERSHAFT - VARIATOR DRIVE	064168.1	1	1003635	4014486488753
28	COUNTERSHAFT - VARIATOR DRIVE	064168.2	1	1003635	4014486488753
31	ROTARY SIEVE DRIVE (TO NR. 15900370)	644267.0	1	1000243	4014486463613
32	ROTARY SIEVE COUNTERSHAFT NR. 15900151-15900370	233839.2	3	1003758	4014486463002
32	ROTARY SIEVE DRIVE (TO NR. 15900150)	633030.2	1	1000220	4014486462838
34	REEL DRIVE FROM 6.0 M CUTTING TABLE	670224.1	1	1001158	4014486497380
36	STRAW CHOPPER (GRAIN)	061701.1	1	1000790	4014486472066
36	STRAW CHOPPER (GRAIN)	061701.2	1	1000790	4014486472066
36	STRAW CHOPPER (MAIZE)	061872.0	2	1002867	4014486471939

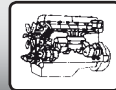

## CLAAS

37	COUNTERSHAFT (2ND STAGE) - STRAW CHOPPER	061700.0	1	1003356	4014486486131
37	INTERMEDIATE DRIVE II CHOPPER	061700.1	1	1003356	4014486486131
38	COUNTERSHAFT - STRAW STRIPPER DRUM	603247.1	1	1003626	4014486488111
39	COUNTERSHAFT (PRIMARY) - STRAW CHOPPER	061700.0	1	1003356	4014486486131
40	1. AND 2. SEPARATOR CYLINDER	644014.0	1	1002319	4014486480078
40	1. AND 2. SEPARATOR CYLINDER	644014.1	1	1002319	4014486480078
41	CYLINDER N=650-1500 RPM (TO NR. 15900310)	628630.0	1	1001208	4014486497670
41	CYLINDER N=500-1400 RPM	644177.0	1	1001221	4014486497762
41	INTERMEDIATE DRIVE THRESHING MECHANISM FROM NO. 15900371	644418.0	1	1001212	4014486497717
41	INTERMEDIATE DRIVE THRESHING MECHANISM FROM NO. 15900371	644418.1	1	1001212	4014486497717
41	AT HIGH - LOW SPEED RANGE TRANSMISSION FROM NO. 15900581	661429.0	1	1001212	4014486497717
43		680334.1	1	1001819	4014486488364
45	ROTOR DRIVE FROM NO. 15900371	680334.0	1	1001819	4014486488364
45	ROTOR DRIVE FROM NO. 15900371	680334.1	1	1001819	4014486488364
46	ROTARY SIEVE (FROM NR. 15900371)	661345.0	1	1000160	4014486461824
47	ROTARY SIEVE COUNTERSHAFT (FROM NR. 15900371)	661245.0	1	1003377	4014486461435
48	DISTRIBUTOR - N=531 RPM (FROM NR. 70910057)	501925.0	1	1003449	4014486465501
48	DISTRIBUTOR - N=531 RPM (TO NR. 70910056)	802931.0	1	1003456	4014486465945
49	DISTRIBUTOR - N=676 RPM (FROM NR. 70910057)	687046.0	1	1003448	4014486465495
49	FOR CHAFF SPREADER TO NO. 70910056 AT 676 MIN-1	750288.0	4	1002794	4014486465853
49	FOR CHAFF SPREADER TO NO. 70910056 AT 676 MIN-1	750288.1	4	1002794	4014486465853
50	ALTERNATOR DRIVE (TO NR. 15900370)	133528.0	1	1002560	4014486495102
50	ALTERNATOR DRIVE (FROM NR. 15900371)	133640.0	1	1003746	4014486495928
51	WATERPUMP DRIVE (FROM NR. 15900370)	133630.0	2	1002961	4014486495058
51	WATERPUMP DRIVE (FROM NR. 15900370)	133630.1	2	1002961	4014486495058
	CONVEYOR SHAFT 1463 MM	603017.2	2	1000833	4014486472592
	FAN DRIVE VARIABLE SPEED	603380.1	1	1001080	4014486498240
	CONVEYOR SHAFT 1306 MM (TO NR. 15900460)	603430.1	2	1000823	4014486472493
	HYDRAULIC PUMP DRIVE (FROM NR. 15900371)	633030.1	1	1000220	4014486462838
	ROTARY SIEVE DRIVE (TO NR. 15900150)	633030.1	1	1000220	4014486462838
	CONVEYOR SHAFT 1306 MM (FROM NR. 15900461)	644419.1	2	1000832	4014486472585
	DISTRIBUTOR - N=676 RPM (FROM NR. 70910057)	687046.1	1	1000323	4014486465471

## COMMANDOR 116 CS

0	INTERMEDIATE DRIVE VARIABLE SPEED DRIVE	064168.0	1	1003635	4014486488753
0	FOR STRAW SPREADER	506671.0	1	1000506	4014486467840
0	FOR STRAW SPREADER	506671.1	1	1000506	4014486467840
0	SHAFTS DISTANCE 1463 MM	603017.0	2	1000833	4014486472592
0	HYDRAULIC PUMP FROM NO. 15900371	633030.0	1	1000220	4014486462838
0	TO NO. 15900150	633030.0	1	1000220	4014486462838
0	AT 5.1 M CUTTERBAR	713506.0	1	1000315	4014486465310
0	FOR CHAFF SPREADER	713506.0	1	1000315	4014486465310
0	FOR CHAFF SPREADER TO NO. 70910056 AT 676 MIN-1	750288.1	4	1002794	4014486465853
1	TRAVEL DRIVE (TO NR. 15900370)	644017.0	1	1001236	4014486491906
1	TRAVEL DRIVE (FROM NR. 15900371)	661092.1	1	1001238	4014486491920
2	HYDRAULIC PUMP DRIVE (TO NR. 15900370)	629002.0	1	1003395	4014486462715
2	HYDRAULIC PUMP DRIVE (TO NR. 15900370)	629002.1	1	1003395	4014486462715
2	HYDRAULIC PUMP DRIVE (FROM NR. 15900371)	633030.2	1	1000220	4014486462838
3	AIR CONDITIONING COMPRESSOR DRIVE	629908.0	1	1002332	4014486478631
3	AIR CONDITIONING COMPRESSOR DRIVE	629908.1	1	1002332	4014486478631
4	TANK UNLOADING (TO NR. 15900370)	629763.0	1	1003593	4014486484977
4	TANK UNLOADING (FROM NR. 15900371)	661093.0	1	1001581	4014486484885
5	THRESHING CYLINDER (TO NR. 15900370)	644018.1	1	1001243	4014486491982
5	INTERMEDIATE DRIVE THRESHING MECHANISM FROM NO. 15900371	644403.0	1	1001247	4014486492033
6	COUNTERSHAFT - FAN DRIVE	603337.0	1	1000662	4014486470260

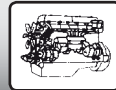

## CLAAS

7	SHAKER SHOE DRIVE (TO NR. 15900370)	603336.0	1	1000478	4014486467499
7	SHAKER SHOE DRIVE (TO NR. 15900370)	603336.1	1	1000478	4014486467499
7	SHAKER SHOE DRIVE (FROM NR. 15900371)	644141.1	1	1000476	4014486467475
10	AT 5.1 M CUTTERBAR	670224.1	1	1001158	4014486497380
12	SHAFTS DISTANCE 1463 MM	603017.3	2	1000833	4014486472592
12	CONVEYOR SHAFT 1306 MM (TO NR. 15900460)	603430.0	2	1000823	4014486472493
12	CONVEYOR SHAFT 1306 MM (FROM NR. 15900461)	644419.0	2	1000832	4014486472585
13	CORN PICKER FOLDING	629142.0	1	1001954	4014486490596
13	FOR CORN PICKER	692149.0	1	1001852	4014486488869
13	FOR CORN PICKER	692150.0	1	1001857	4014486488920
16	CUTTING MECHANICAL FROM 6.0 M CUTTING TABLE	671013.1	1	1000676	4014486470482
19	CUTTING MECHANICAL BY 5.1 M CUTTING TABLE	713506.0	1	1000315	4014486465310
19	CUTTING MECHANICAL BY 5.1 M CUTTING TABLE	713506.1	1	1000315	4014486465310
19	CUTTING MECHANICAL BY 5.1 M CUTTING TABLE	713506.2	1	1000315	4014486465310
21	FAN	603380.1	1	1001080	4014486498240
22	SHAKER SHOE DRIVE	609762.0	1	1001713	4014486486919
23	FOR STRAW DISTRIBUTOR	506671.2	1	1000506	4014486467840
23	DISTRIBUTOR GRAIN	713506.0	1	1000315	4014486465310
23	DISTRIBUTOR GRAIN	713506.1	1	1000315	4014486465310
23	DISTRIBUTOR GRAIN	713506.2	1	1000315	4014486465310
24	STRAW DISTRIBUTOR	640653.1	1	1000350	4014486466065
25	8. SEPARATOR DRUM	644014.0	1	1002319	4014486480078
25	8. SEPARATOR DRUM	644014.1	1	1002319	4014486480078
26	SEPARATOR CYLINDER 3. 5. 6. AND 7	644015.1	1	1002913	4014486484601
27	SEPARATOR CYLINDER 4.	644016.1	1	1001800	4014486488104
28	COUNTERSHAFT - VARIATOR DRIVE	064168.0	1	1003635	4014486488753
28	COUNTERSHAFT - VARIATOR DRIVE	064168.1	1	1003635	4014486488753
28	COUNTERSHAFT - VARIATOR DRIVE	064168.2	1	1003635	4014486488753
31	ROTARY SIEVE DRIVE (TO NR. 15900370)	644267.0	1	1000243	4014486463613
32	ROTARY SIEVE COUNTERSHAFT NR. 15900151-15900370	233839.2	3	1003758	4014486463002
32	ROTARY SIEVE DRIVE (TO NR. 15900150)	633030.2	1	1000220	4014486462838
34	REEL DRIVE FROM 6.0 M CUTTING TABLE	670224.1	1	1001158	4014486497380
36	STRAW CHOPPER (GRAIN)	061701.1	1	1000790	4014486472066
36	STRAW CHOPPER (GRAIN)	061701.2	1	1000790	4014486472066
36	CHOPPER, CORN	061872.0	2	1002867	4014486471939
38	COUNTERSHAFT - STRAW STRIPPER DRUM	603247.1	1	1003626	4014486488111
39	INTERMEDIATE DRIVE I CHOPPER	061700.1	1	1003356	4014486486131
40	1. AND 2. SEPARATOR CYLINDER	644014.0	1	1002319	4014486480078
40	1. AND 2. SEPARATOR CYLINDER	644014.1	1	1002319	4014486480078
41	CYLINDER N=650-1500 RPM (TO NR. 15900310)	628630.0	1	1001208	4014486497670
41	INTERMEDIATE DRIVE THRESHING MECHANISM FROM NO. 15900371	644418.0	1	1001212	4014486497717
41	INTERMEDIATE DRIVE THRESHING MECHANISM FROM NO. 15900371	644418.1	1	1001212	4014486497717
41	AT HIGH - LOW SPEED RANGE TRANSMISSION FROM NO. 15900581	661429.0	1	1001212	4014486497717
41	AT N 500 - 1500 MIN-1	661430.0	1	1001229	4014486497830
44	FOR HPH - G CHOPPER	695610.0	1	No AP	
45	ROTOR DRIVE FROM NO. 15900371	680334.0	1	1001819	4014486488364
45	ROTOR DRIVE FROM NO. 15900371	680334.1	1	1001819	4014486488364
46	ROTARY SIEVE (FROM NR. 15900371)	661345.0	1	1000160	4014486461824
47	ROTARY SIEVE COUNTERSHAFT (FROM NR. 15900371)	661245.0	1	1003377	4014486461435
48	DISTRIBUTOR - N=531 RPM (FROM NR. 70910057)	501925.0	1	1003449	4014486465501
48	DISTRIBUTOR - N=531 RPM (TO NR. 70910056)	802931.0	1	1003456	4014486465945
49	FOR CHAFF SPREADER FROM NO. 70910057 AT 676 MIN-1	687046.1	1	1000323	4014486465471
49	FOR CHAFF SPREADER TO NO. 70910056 AT 676 MIN-1	750288.0	4	1002794	4014486465853
50	ALTERNATOR DRIVE (TO NR. 15900370)	133528.0	1	1002560	4014486495102
50	ALTERNATOR DRIVE (FROM NR. 15900371)	133640.0	1	1003746	4014486495928

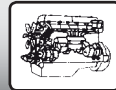
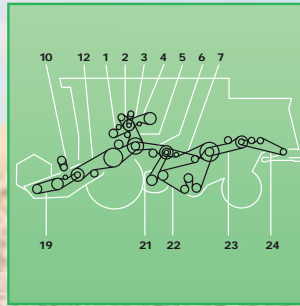
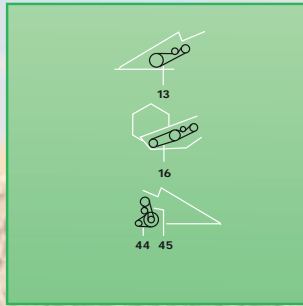
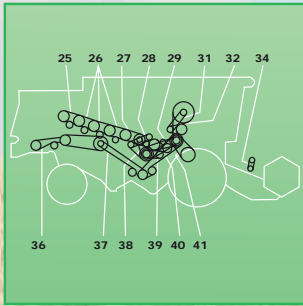

## CLAAS

51	WATERPUMP DRIVE (FROM NR. 15900370)	133630.1	2	1002961	4014486495058
52	RADIATOR CONCAVE SUCTION FROM NO. 15900371	644448.0	1	1000139	4014486461565
	SHAFTS DISTANCE 1463 MM	603017.2	2	1000833	4014486472592
	SHAFTS DISTANCE 1306 MM TO NO. 15900460	603430.1	2	1000823	4014486472493
	HYDRAULIC PUMP FROM NO. 15900371	633030.1	1	1000220	4014486462838
	TO NO. 15900150	633030.1	1	1000220	4014486462838
	TO NO. 15900370	644017.1	1	1001236	4014486491906
	SHAFTS DISTANCE 1306 MM FROM NO. 15900461	644419.1	2	1000832	4014486472585

## COMMANDOR 228

0	CONVEYOR SHAFT 1463 MM	603017.0	2	1000833	4014486472592
0	HYDRAULIC PUMP DRIVE (FROM NR. 15900371)	633030.0	1	1000220	4014486462838
0	ROTARY SIEVE DRIVE (TO NR. 15900150)	633030.0	1	1000220	4014486462838
0	DISTRIBUTOR - N=676 RPM (TO NR. 70910056)	750288.1	4	1002794	4014486465853
1	TRAVEL DRIVE (TO NR. 15900370)	644017.0	1	1001236	4014486491906
1	TRAVEL DRIVE (TO NR. 15900370)	644017.1	1	1001236	4014486491906
1	TRAVEL DRIVE (FROM NR. 15900371)	661092.1	1	1001238	4014486491920
2	HYDRAULIC PUMP DRIVE (TO NR. 15900370)	629002.0	1	1003395	4014486462715
2	HYDRAULIC PUMP DRIVE (TO NR. 15900370)	629002.1	1	1003395	4014486462715
2	HYDRAULIC PUMP DRIVE (FROM NR. 15900371)	633030.2	1	1000220	4014486462838
3	AIR CONDITIONING COMPRESSOR DRIVE	629908.0	1	1002332	4014486478631
3	AIR CONDITIONING COMPRESSOR DRIVE	629908.1	1	1002332	4014486478631
4	TANK UNLOADING (TO NR. 15900370)	629763.0	1	1003593	4014486484977
4	TANK UNLOADING (FROM NR. 15900371)	661093.0	1	1001581	4014486484885
5	THRESHING CYLINDER (TO NR. 15900370)	644018.1	1	1001243	4014486491982
5	INTERMEDIATE DRIVE THRESHING MECHANISM FROM NO. 15900371	644403.0	1	1001247	4014486492033
6	COUNTERSHAFT - FAN DRIVE	603337.0	1	1000662	4014486470260
7	SHAKER SHOE DRIVE (TO NR. 15900370)	603336.0	1	1000478	4014486467499
7	SHAKER SHOE DRIVE (TO NR. 15900370)	603336.1	1	1000478	4014486467499
7	SHAKER SHOE DRIVE (FROM NR. 15900371)	644141.1	1	1000476	4014486467475
10	REEL DRIVE BY 5.1 M CUTTING TABLE	670224.1	1	1001158	4014486497380
12	CONVEYOR SHAFT 1463 MM	603017.3	2	1000833	4014486472592
12	CONVEYOR SHAFT 1306 MM (TO NR. 15900460)	603430.0	2	1000823	4014486472493
12	CONVEYOR SHAFT 1306 MM (FROM NR. 15900461)	644419.0	2	1000832	4014486472585
13	CUTTING TABLE DRIVE (MAIZE)	629142.0	1	1001954	4014486490596
13		692149.0	1	1001852	4014486488869
13	FOR MAIZE PICKER	692149.0	1	1001852	4014486488869
13	FOR MAIZE PICKER HINGED	692150.0	1	1001857	4014486488920
16	CUTTING MECHANICAL FROM 6.0 M CUTTING TABLE	671013.1	1	1000676	4014486470482
19	CUTTING MECHANICAL BY 5.1 M CUTTING TABLE	713506.0	1	1000315	4014486465310
19	CUTTING MECHANICAL BY 5.1 M CUTTING TABLE	713506.1	1	1000315	4014486465310
19	CUTTING MECHANICAL BY 5.1 M CUTTING TABLE	713506.2	1	1000315	4014486465310
21	FAN DRIVE VARIABLE SPEED	603380.0	1	1001080	4014486498240
22	SHAKER SHOE DRIVE	609762.0	1	1001713	4014486486919
23	FOR STRAW DISTRIBUTOR	506671.0	1	1000506	4014486467840
23	FOR STRAW DISTRIBUTOR	506671.1	1	1000506	4014486467840
23	FOR STRAW DISTRIBUTOR	506671.2	1	1000506	4014486467840
23	DISTRIBUTOR GRAIN	713506.0	1	1000315	4014486465310
23	DISTRIBUTOR GRAIN	713506.1	1	1000315	4014486465310
23	DISTRIBUTOR GRAIN	713506.2	1	1000315	4014486465310
24	STRAW DISTRIBUTOR	640653.1	1	1000350	4014486466065
25	8. SEPARATOR DRUM	644014.0	1	1002319	4014486480078
25	8. SEPARATOR DRUM	644014.1	1	1002319	4014486480078
26	SEPARATOR CYLINDER 3. 5. 6. AND 7	644015.1	1	1002913	4014486484601
27	SEPARATOR CYLINDER 4.	644016.1	1	1001800	4014486488104



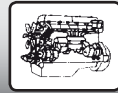

## CLAAS

28	COUNTERSHAFT - VARIATOR DRIVE	064168.0	1	1003635	4014486488753
28	COUNTERSHAFT - VARIATOR DRIVE	064168.1	1	1003635	4014486488753
28	COUNTERSHAFT - VARIATOR DRIVE	064168.2	1	1003635	4014486488753
31	ROTARY SIEVE DRIVE (TO NR. 15900370)	644267.0	1	1000243	4014486463613
32	ROTARY SIEVE COUNTERSHAFT NR. 15900151-15900370	233839.2	3	1003758	4014486463002
32	ROTARY SIEVE DRIVE (TO NR. 15900150)	633030.2	1	1000220	4014486462838
34	REEL DRIVE FROM 6.0 M CUTTING TABLE	670224.1	1	1001158	4014486497380
36	STRAW CHOPPER (GRAIN)	061701.1	1	1000790	4014486472066
36	STRAW CHOPPER (GRAIN)	061701.2	1	1000790	4014486472066
36	STRAW CHOPPER (MAIZE)	061872.0	2	1002867	4014486471939
37	COUNTERSHAFT (2ND STAGE) - STRAW CHOPPER	061700.0	1	1003356	4014486486131
37	INTERMEDIATE DRIVE II CHOPPER	061700.1	1	1003356	4014486486131
38	COUNTERSHAFT - STRAW STRIPPER DRUM	603247.1	1	1003626	4014486488111
39	COUNTERSHAFT (PRIMARY) - STRAW CHOPPER	061700.0	1	1003356	4014486486131
40	1. AND 2. SEPARATOR CYLINDER	644014.0	1	1002319	4014486480078
40	1. AND 2. SEPARATOR CYLINDER	644014.1	1	1002319	4014486480078
41	CYLINDER N=650-1500 RPM (TO NR. 15900310)	628630.0	1	1001208	4014486497670
41	CYLINDER N=500-1400 RPM	644177.0	1	1001221	4014486497762
41	INTERMEDIATE DRIVE THRESHING MECHANISM FROM NO. 15900371	644418.0	1	1001212	4014486497717
41	INTERMEDIATE DRIVE THRESHING MECHANISM FROM NO. 15900371	644418.1	1	1001212	4014486497717
41	AT HIGH - LOW SPEED RANGE TRANSMISSION FROM NO. 15900581	661429.0	1	1001212	4014486497717
45	ROTOR DRIVE FROM NO. 15900371	680334.0	1	1001819	4014486488364
45	ROTOR DRIVE FROM NO. 15900371	680334.1	1	1001819	4014486488364
46	ROTARY SIEVE (FROM NR. 15900371)	661345.0	1	1000160	4014486461824
47	ROTARY SIEVE COUNTERSHAFT (FROM NR. 15900371)	661245.0	1	1003377	4014486461435
48	DISTRIBUTOR - N=531 RPM (FROM NR. 70910057)	501925.0	1	1003449	4014486465501
48	DISTRIBUTOR - N=531 RPM (TO NR. 70910056)	802931.0	1	1003456	4014486465945
49	DISTRIBUTOR - N=676 RPM (FROM NR. 70910057)	687046.0	1	1003448	4014486465495
49	FOR CHAFF SPREADER TO NO. 70910056 AT 676 MIN-1	750288.0	4	1002794	4014486465853
50	ALTERNATOR DRIVE (TO NR. 15900370)	133528.0	1	1002560	4014486495102
50	ALTERNATOR DRIVE (FROM NR. 15900371)	133640.0	1	1003746	4014486495928
51	WATERPUMP DRIVE (FROM NR. 15900370)	133630.0	2	1002961	4014486495058
51	WATERPUMP DRIVE (FROM NR. 15900370)	133630.1	2	1002961	4014486495058
	CONVEYOR SHAFT 1463 MM	603017.2	2	1000833	4014486472592
	FAN DRIVE VARIABLE SPEED	603380.1	1	1001080	4014486498240
	CONVEYOR SHAFT 1306 MM (TO NR. 15900460)	603430.1	2	1000823	4014486472493
	HYDRAULIC PUMP DRIVE (FROM NR. 15900371)	633030.1	1	1000220	4014486462838
	ROTARY SIEVE DRIVE (TO NR. 15900150)	633030.1	1	1000220	4014486462838
	CONVEYOR SHAFT 1306 MM (FROM NR. 15900461)	644419.1	2	1000832	4014486472585
	DISTRIBUTOR - N=676 RPM (FROM NR. 70910057)	687046.1	1	1000323	4014486465471

## COMMANDOR 228 CS

0	INTERMEDIATE DRIVE VARIABLE SPEED DRIVE	064168.0	1	1003635	4014486488753
0	FOR STRAW SPREADER	506671.0	1	1000506	4014486467840
0	FOR STRAW SPREADER	506671.1	1	1000506	4014486467840
0	SHAFTS DISTANCE 1463 MM	603017.0	2	1000833	4014486472592
0	HYDRAULIC PUMP FROM NO. 15900371	633030.0	1	1000220	4014486462838
0	TO NO. 15900150	633030.0	1	1000220	4014486462838
0	AT 5.1 M CUTTERBAR	713506.0	1	1000315	4014486465310
0	FOR CHAFF SPREADER	713506.0	1	1000315	4014486465310
0	FOR CHAFF SPREADER TO NO. 70910056 AT 676 MIN-1	750288.1	4	1002794	4014486465853
1	TRAVEL DRIVE (TO NR. 15900370)	644017.0	1	1001236	4014486491906
1	TRAVEL DRIVE (FROM NR. 15900371)	661092.1	1	1001238	4014486491920
2	HYDRAULIC PUMP DRIVE (TO NR. 15900370)	629002.0	1	1003395	4014486462715
2	HYDRAULIC PUMP DRIVE (TO NR. 15900370)	629002.1	1	1003395	4014486462715



## CLAAS

2	HYDRAULIC PUMP DRIVE (FROM NR. 15900371)	633030.2	1	1000220	4014486462838
3	AIR CONDITIONING COMPRESSOR DRIVE	629908.0	1	1002332	4014486478631
3	AIR CONDITIONING COMPRESSOR DRIVE	629908.1	1	1002332	4014486478631
4	TANK UNLOADING (TO NR. 15900370)	629763.0	1	1003593	4014486484977
4	TANK UNLOADING (FROM NR. 15900371)	661093.0	1	1001581	4014486484885
5	THRESHING CYLINDER (TO NR. 15900370)	644018.1	1	1001243	4014486491982
5	INTERMEDIATE DRIVE THRESHING MECHANISM FROM NO. 15900371	644403.0	1	1001247	4014486492033
6	COUNTERSHAFT - FAN DRIVE	603337.0	1	1000662	4014486470260
7	SHAKER SHOE DRIVE (TO NR. 15900370)	603336.0	1	1000478	4014486467499
7	SHAKER SHOE DRIVE (TO NR. 15900370)	603336.1	1	1000478	4014486467499
7	SHAKER SHOE DRIVE (FROM NR. 15900371)	644141.1	1	1000476	4014486467475
10	AT 5.1 M CUTTERBAR	670224.1	1	1001158	4014486497380
12	SHAFTS DISTANCE 1463 MM	603017.3	2	1000833	4014486472592
12	CONVEYOR SHAFT 1306 MM (TO NR. 15900460)	603430.0	2	1000823	4014486472493
12	CONVEYOR SHAFT 1306 MM (FROM NR. 15900461)	644419.0	2	1000832	4014486472585
13	CORN PICKER FOLDING	629142.0	1	1001954	4014486490596
13	FOR CORN PICKER	692149.0	1	1001852	4014486488869
13	FOR CORN PICKER	692150.0	1	1001857	4014486488920
16	CUTTING MECHANICAL FROM 6.0 M CUTTING TABLE	671013.1	1	1000676	4014486470482
19	CUTTING MECHANICAL BY 5.1 M CUTTING TABLE	713506.0	1	1000315	4014486465310
19	CUTTING MECHANICAL BY 5.1 M CUTTING TABLE	713506.1	1	1000315	4014486465310
19	CUTTING MECHANICAL BY 5.1 M CUTTING TABLE	713506.2	1	1000315	4014486465310
21	FAN	603380.1	1	1001080	4014486498240
22	SHAKER SHOE DRIVE	609762.0	1	1001713	4014486486919
23	FOR STRAW DISTRIBUTOR	506671.2	1	1000506	4014486467840
23	DISTRIBUTOR GRAIN	713506.0	1	1000315	4014486465310
23	DISTRIBUTOR GRAIN	713506.1	1	1000315	4014486465310
23	DISTRIBUTOR GRAIN	713506.2	1	1000315	4014486465310
24	STRAW DISTRIBUTOR	640653.1	1	1000350	4014486466065
25	8. SEPARATOR DRUM	644014.0	1	1002319	4014486480078
25	8. SEPARATOR DRUM	644014.1	1	1002319	4014486480078
26	SEPARATOR CYLINDER 3. 5. 6. AND 7	644015.1	1	1002913	4014486484601
27	SEPARATOR CYLINDER 4.	644016.1	1	1001800	4014486488104
28	COUNTERSHAFT - VARIATOR DRIVE	064168.0	1	1003635	4014486488753
28	COUNTERSHAFT - VARIATOR DRIVE	064168.1	1	1003635	4014486488753
28	COUNTERSHAFT - VARIATOR DRIVE	064168.2	1	1003635	4014486488753
31	ROTARY SIEVE DRIVE (TO NR. 15900370)	644267.0	1	1000243	4014486463613
32	ROTARY SIEVE COUNTERSHAFT NR. 15900151-15900370	233839.2	3	1003758	4014486463002
32	ROTARY SIEVE DRIVE (TO NR. 15900150)	633030.2	1	1000220	4014486462838
34	REEL DRIVE FROM 6.0 M CUTTING TABLE	670224.1	1	1001158	4014486497380
36	STRAW CHOPPER (GRAIN)	061701.1	1	1000790	4014486472066
36	STRAW CHOPPER (GRAIN)	061701.2	1	1000790	4014486472066
36	CHOPPER, CORN	061872.0	2	1002867	4014486471939
38	COUNTERSHAFT - STRAW STRIPPER DRUM	603247.1	1	1003626	4014486488111
39	INTERMEDIATE DRIVE I CHOPPER	061700.1	1	1003356	4014486486131
40	1. AND 2. SEPARATOR CYLINDER	644014.0	1	1002319	4014486480078
40	1. AND 2. SEPARATOR CYLINDER	644014.1	1	1002319	4014486480078
41	CYLINDER N=650-1500 RPM (TO NR. 15900310)	628630.0	1	1001208	4014486497670
41	INTERMEDIATE DRIVE THRESHING MECHANISM FROM NO. 15900371	644418.0	1	1001212	4014486497717
41	INTERMEDIATE DRIVE THRESHING MECHANISM FROM NO. 15900371	644418.1	1	1001212	4014486497717
41	AT HIGH - LOW SPEED RANGE TRANSMISSION FROM NO. 15900581	661429.0	1	1001212	4014486497717
41	AT N 500 - 1500 MIN-1	661430.0	1	1001229	4014486497830
44	FOR HPH - G CHOPPER	695610.0	1	No AP	
45	ROTOR DRIVE FROM NO. 15900371	680334.0	1	1001819	4014486488364
45	ROTOR DRIVE FROM NO. 15900371	680334.1	1	1001819	4014486488364

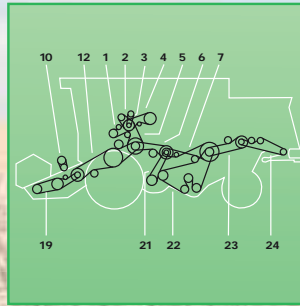
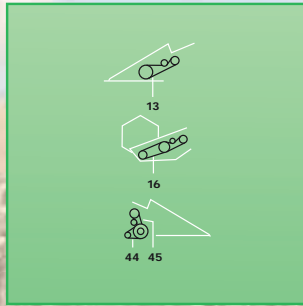
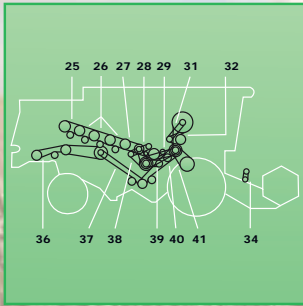

## CLAAS

46	ROTARY SIEVE (FROM NR. 15900371)	661345.0	1	1000160	4014486461824
47	ROTARY SIEVE COUNTERSHAFT (FROM NR. 15900371)	661245.0	1	1003377	4014486461435
48	DISTRIBUTOR - N=531 RPM (FROM NR. 70910057)	501925.0	1	1003449	4014486465501
48	DISTRIBUTOR - N=531 RPM (TO NR. 70910056)	802931.0	1	1003456	4014486465945
49	FOR CHAFF SPREADER FROM NO. 70910057 AT 676 MIN-1	687046.1	1	1000323	4014486465471
49	FOR CHAFF SPREADER TO NO. 70910056 AT 676 MIN-1	750288.0	4	1002794	4014486465853
50	ALTERNATOR DRIVE (TO NR. 15900370)	133528.0	1	1002560	4014486495102
50	ALTERNATOR DRIVE (FROM NR. 15900371)	133640.0	1	1003746	4014486495928
51	WATERPUMP DRIVE (FROM NR. 15900370)	133630.1	2	1002961	4014486495058
52	RADIATOR CONCAVE SUCTION FROM NO. 15900371	644448.0	1	1000139	4014486461565
	SHAFTS DISTANCE 1463 MM	603017.2	2	1000833	4014486472592
	SHAFTS DISTANCE 1306 MM TO NO. 15900460	603430.1	2	1000823	4014486472493
	HYDRAULIC PUMP FROM NO. 15900371	633030.1	1	1000220	4014486462838
	TO NO. 15900150	633030.1	1	1000220	4014486462838
	TO NO. 15900370	644017.1	1	1001236	4014486491906
	SHAFTS DISTANCE 1306 MM FROM NO. 15900461	644419.1	2	1000832	4014486472585

## CONSUL

0	KNIFE DRIVE	778717.1	2	1004307	4014486714937
1	CUTTING TABLE DRIVE	702509.0	1	1001090	4014486496727
2	CYLINDER DRIVE	702536.0	1	1001200	4014486497564
3	REEL DRIVE VARIABLE SPEED	778561.0	1	1001038	4014486496376
4	KNIFE DRIVE	778717.0	2	1004307	4014486714937
5	SHAKER SHOE DRIVE	610830.0	2	1002789	4014486466249
6	TRACTION VARIATOR DRIVE	702536.0	1	1001200	4014486497564
7	COUNTERSHAFT DRIVE	703314.0	1	1000296	4014486464887
8	UNLOADING AUGER DRIVE	706087.0	1	1000365	4014486466263
9	STRAW SPREADER DRIVE	706829.0	1	1000524	4014486468045
10	HYDRAULIC PUMP DRIVE	713506.0	1	1000315	4014486465310
10	HYDRAULIC PUMP DRIVE	713506.1	1	1000315	4014486465310
10	HYDRAULIC PUMP DRIVE	713506.2	1	1000315	4014486465310
11	TRACTION DRIVE	720695.0	1	1000734	4014486471281
12	TURNING DRUM DRIVE	720696.0	1	1000467	4014486467383
12	TURNING DRUM DRIVE	720866.0	1	1003607	4014486485721
13	RADIATOR FAN DRIVE	721306.0	1	1002276	4014486478440
13	RADIATOR FAN DRIVE	721307.0	1	1002277	4014486478457
14	STRAW WALKER DRIVE	774099.0	1	1000511	4014486467895
15	FAN MILL VARIABLE SPEED	778561.0	1	1001038	4014486496376
	SHAKER SHOE DRIVE	610830.1	2	1002789	4014486466249
	TURNING DRUM DRIVE	720696.1	1	No AP	

## CORTO 3100

0		618123.0	1	1003434	4014486464634
---	--	----------	---	---------	---------------

## DOMINATOR 100

0	COUNTERSHAFT DRIVE	060306.2	1	1000723	4014486471151
0	COUNTERSHAFT DRIVE	060306.3	1	No AP	
0	STRAW CHOPPER DRIVE	061253.1	1	1000873	4014486473131
0	ELEVATOR DRIVE UNIT	629732.2	1	1000417	4014486520507
0	DRIVE GRAIN TANK	673614.1	1	1001566	4014486484694
1	REEL DRIVE VARIABLE SPEED	670224.0	1	1001158	4014486497380
2	CUTTING TABLE DRIVE	672353.0	2	1002875	4014486472349
3	THRESHING MACHINE	629000.0	1	1003661	4014486490657
4	HYDRAULIC PUMP TRACTION DRIVE	629001.0	1	1001934	4014486490305
5	HYDRAULIC PUMP DRIVE	629002.0	1	1003395	4014486462715

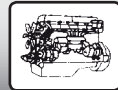

## CLAAS

5	HYDRAULIC PUMP DRIVE	629002.1	1	1003395	4014486462715
6	DRIVE GRAIN TANK	673614.0	1	1001566	4014486484694
7	SHAKER SHOE FANNING MILL	672358.0	1	1000662	4014486470260
8	STRAW WALKER DRIVE	629036.0	1	1000515	4014486467949
9	KNIFE DRIVE	629214.0	1	1002317	4014486480054
9	KNIFE DRIVE	769202.0	1	1000495	4014486467680
9	KNIFE DRIVE	769202.1	1	1000495	4014486467680
10	FAN DRIVE VARIABLE SPEED	671209.0	1	1001039	4014486496383
12	AUGER (GRAIN)	629081.0	1	1000754	4014486471533
12	AUGER (GRAIN)	629081.1	1	1000754	4014486471533
13	ELEVATOR DRIVE UNIT	629732.0	1	1000415	4014486466782
14	FEEDER ELEVATOR	501925.0	1	1003449	4014486465501
15	COUNTERSHAFT DRIVE	060306.0	1	1000723	4014486471151
16	AIR INTAKE DRIVE	802931.0	1	1003456	4014486465945
17	STRAW CHOPPER DRIVE	061253.0	1	1000873	4014486473131
18	CYLINDER VARIATOR DRIVE	629035.0	1	1001289	4014486520545
19	THRESHING MACHINE	629510.0	1	1003634	4014486488623
19	THRESHING MACHINE	629510.1	1	1003634	4014486488623
	THRESHING MACHINE	629000.1	1	1003661	4014486490657
	HYDRAULIC PUMP TRACTION DRIVE	629001.1	1	1001934	4014486490305
	KNIFE DRIVE	629214.1	1	1002317	4014486480054
	ELEVATOR DRIVE UNIT	629732.1	1	1000416	4014486466799
	REEL DRIVE VARIABLE SPEED	670224.1	1	1001158	4014486497380

## DOMINATOR 105

0	COUNTERSHAFT DRIVE	060306.2	1	1000723	4014486471151
0	COUNTERSHAFT DRIVE	060306.3	1	No AP	
0	STRAW CHOPPER DRIVE	061253.1	1	1000873	4014486473131
0	ELEVATOR DRIVE UNIT	629732.2	1	1000417	4014486520507
0	DRIVE GRAIN TANK	673614.1	1	1001566	4014486484694
1	REEL DRIVE VARIABLE SPEED	670224.0	1	1001158	4014486497380
2	CUTTING TABLE DRIVE	672353.0	2	1002875	4014486472349
3	THRESHING MACHINE	629000.0	1	1003661	4014486490657
4	HYDRAULIC PUMP TRACTION DRIVE	629001.0	1	1001934	4014486490305
5	HYDRAULIC PUMP DRIVE	629002.0	1	1003395	4014486462715
5	HYDRAULIC PUMP DRIVE	629002.1	1	1003395	4014486462715
6	DRIVE GRAIN TANK	673614.0	1	1001566	4014486484694
7	SHAKER SHOE FANNING MILL	672358.0	1	1000662	4014486470260
8	STRAW WALKER DRIVE	629036.0	1	1000515	4014486467949
9	KNIFE DRIVE	629214.0	1	1002317	4014486480054
9	KNIFE DRIVE	769202.0	1	1000495	4014486467680
9	KNIFE DRIVE	769202.1	1	1000495	4014486467680
10	FAN DRIVE VARIABLE SPEED	671209.0	1	1001039	4014486496383
12	AUGER (GRAIN)	629081.0	1	1000754	4014486471533
12	AUGER (GRAIN)	629081.1	1	1000754	4014486471533
13	ELEVATOR DRIVE UNIT	629732.0	1	1000415	4014486466782
14	FEEDER ELEVATOR	501925.0	1	1003449	4014486465501
15	COUNTERSHAFT DRIVE	060306.0	1	1000723	4014486471151
16	AIR INTAKE DRIVE	802931.0	1	1003456	4014486465945
17	STRAW CHOPPER DRIVE	061253.0	1	1000873	4014486473131
18	CYLINDER VARIATOR DRIVE	629035.0	1	1001289	4014486520545
19	THRESHING MACHINE	629510.0	1	1003634	4014486488623
19	THRESHING MACHINE	629510.1	1	1003634	4014486488623
	THRESHING MACHINE	629000.1	1	1003661	4014486490657
	HYDRAULIC PUMP TRACTION DRIVE	629001.1	1	1001934	4014486490305

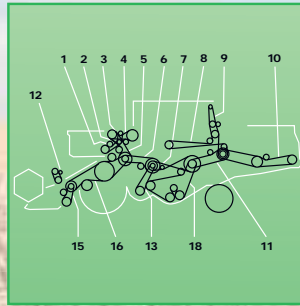
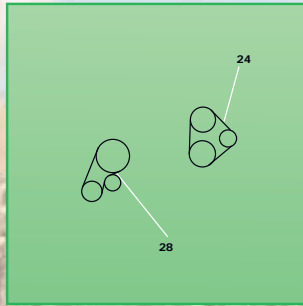
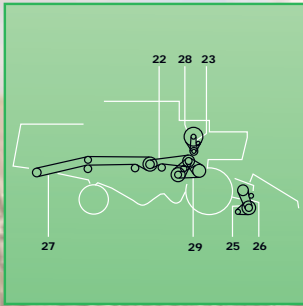

# CLAAS

	KNIFE DRIVE	629214.1	1	1002317	4014486480054
	ELEVATOR DRIVE UNIT	629732.1	1	1000416	4014486466799
	REEL DRIVE VARIABLE SPEED	670224.1	1	1001158	4014486497380

## DOMINATOR 106

0	COUNTERSHAFT DRIVE	060306.3	1	No AP	
0	COUNTERSHAFT DRIVE	060306.4	1	1000723	4014486471151
0	ELEVATOR DRIVE UNIT	629732.0	1	1000415	4014486466782
0	GRAIN TANK (OM 360)	673614.1	1	1001566	4014486484694
1	HYDRAULIC PUMP DRIVE (OM 360)	629001.0	1	1001934	4014486490305
1	MAIN (OM 401)	629279.0	1	1001936	4014486490336
2	OM 360	603378.0	1	1003388	4014486462524
2	OM 401	689175.0	1	1003391	4014486462654
3		621903.0	1	1002041	4014486475166
3		621903.1	1	1002041	4014486475166
4	GRAIN TANK (OM 401)	672351.0	1	1001570	4014486484731
4	GRAIN TANK (OM 360)	673614.0	1	1001566	4014486484694
5	MAIN/DRUM	629000.0	1	1003661	4014486490657
6		603337.0	1	1000662	4014486470260
7	RETURN AUGER DRIVE	603336.0	1	1000478	4014486467499
7	RETURN AUGER DRIVE	603336.1	1	1000478	4014486467499
8	ELEVATOR DRIVE UNIT	629732.1	1	1000416	4014486466799
9		640653.0	1	1000350	4014486466065
10		623427.1	1	1000409	4014486466720
11	STRAW WALKER DRIVE	506671.0	1	1000506	4014486467840
11	STRAW WALKER DRIVE	506671.1	1	1000506	4014486467840
11	STRAW WALKER DRIVE	506671.2	1	1000506	4014486467840
	REEL DRIVE VARIABLE SPEED	670224.0	1	1001158	4014486497380
13		603380.0	1	1001080	4014486498240
15	KNIFE DRIVE	629214.0	1	1002317	4014486480054
16	TABLE DRIVE	629441.0	2	1000810	4014486472332
18	SIEVE PAN (TO NR. 9000438)	603033.0	1	1003619	4014486486933
18	SIEVE PAN (FROM NR. 9000439)	609762.0	1	1001713	4014486486919
22	COUNTERSHAFT DRIVE	060306.2	1	1000723	4014486471151
23		603341.0	1	1003328	4014486463217
24	ENGINE (OM 401)	133528.0	1	1002560	4014486495102
24	ENGINE (OM 401)	133549.0	2	1002973	4014486495188
24	ENGINE (OM 401)	133549.1	2	1002973	4014486495188
24	ENGINE (OM 360)	685693.0	2	1003773	4014486495065
25		629410.0	2	1002872	4014486468441
26		680334.0	1	1001819	4014486488364
26		680334.1	1	1001819	4014486488364
27	STRAW CHOPPER DRIVE	061360.0	1	1000870	4014486473094
27	STRAW CHOPPER DRIVE	061360.1	1	1000870	4014486473094
28	DRUM DRIVE	629035.0	1	1001289	4014486520545
28	DRUM DRIVE	629366.1	1	1001821	4014486488395
29	CYLINDER	603354.0	1	1001844	4014486488739
		603380.1	1	1001080	4014486498240
	MAIN/DRUM	629000.1	1	1003661	4014486490657
	HYDRAULIC PUMP DRIVE (OM 360)	629001.1	1	1001934	4014486490305
	KNIFE DRIVE	629214.1	1	1002317	4014486480054
		629410.1	2	1002872	4014486468441
	TABLE DRIVE	629441.1	2	1000810	4014486472332
	ELEVATOR DRIVE UNIT	629732.2	1	1000417	4014486520507
		640653.1	1	1000350	4014486466065

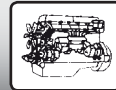
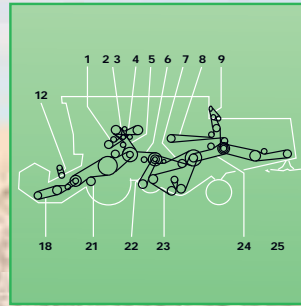
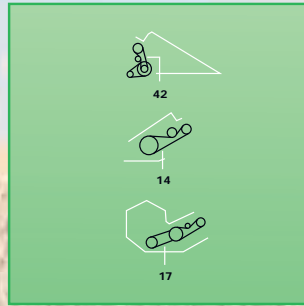
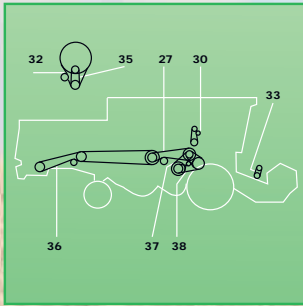

# CLAAS

	REEL DRIVE VARIABLE SPEED	670224.1	1	1001158	4014486497380
<b>DOMINATOR 108 HYDR</b>					
0	STRAW CHOPPER DRIVE	060306.2	1	1000723	4014486471151
0	STRAW CHOPPER DRIVE	060306.3	1	No AP	
0	SHAFT 1463 MM (TO NR. 09404032)	603017.3	2	1000833	4014486472592
0	TO NR. 09404032	629732.2	1	1000417	4014486520507
0	VAR. 7693 / VAR. 7716	661220.0	1	1003340	4014486488807
0		661220.1	1	1003340	4014486488807
1	FOR MERCEDES ENGINE OM 421	629279.0	1	1001936	4014486490336
1	FOR MERCEDES ENGINE OM 366 LA	644405.1	1	1001941	4014486490411
1	FOR MERCEDES ENGINE OM 366 LA	644405.2	1	1001941	4014486490411
1	FOR MERCEDES ENGINE OM 441 A	661092.1	1	1001238	4014486491920
2		689175.0	1	1003391	4014486462654
3		629908.0	1	1002332	4014486478631
3		629908.1	1	1002332	4014486478631
3	FOR VAR. 7705	661114.0	1	1002336	4014486478686
4	TO NR. 09403057	629763.0	1	1003593	4014486484977
4	FOR VAR. 7605	660409.0	1	1001575	4014486484809
4	FOR VAR. 7705	661093.0	1	1001581	4014486484885
5	TO NR. 09403057	629000.0	1	1003661	4014486490657
5	FROM NR. 09403058	644404.0	1	1003354	4014486490763
5	FROM NR. 09403058	644404.1	1	1003354	4014486490763
6		603337.0	1	1000662	4014486470260
7		603336.0	1	1000478	4014486467499
7		603336.1	1	1000478	4014486467499
8	TO NR. 09404032	629732.0	1	1000415	4014486466782
8	FROM NR. 09404033	644447.0	1	1000420	4014486466836
9	NOT AT SERIES MAXI	640653.0	1	1000350	4014486466065
12	FOR 3.9 M - 5.1 M	670224.0	1	1001158	4014486497380
12	FOR 3.9 M - 5.1 M	670224.1	1	1001158	4014486497380
14	FOR MAIZE PICKER	692149.0	1	1001852	4014486488869
14	FOR MAIZE PICKER	692150.0	1	1001857	4014486488920
17	FOR 6.0 M - 9.0 M	671013.0	1	1000674	4014486470468
17	FOR 6.0 M - 9.0 M	671013.1	1	1000676	4014486470482
19	STRAW WALKER DRIVE	713506.0	1	1000315	4014486465310
19	STRAW WALKER DRIVE	713506.1	1	1000315	4014486465310
19	STRAW WALKER DRIVE	713506.2	1	1000315	4014486465310
21	SHAFT 1463 MM (TO NR. 09404032)	603017.0	2	1000833	4014486472592
21	SHAFT 1306 MM (TO NR. 09404032)	603430.0	2	1000823	4014486472493
21	SHAFT BASE 1177 MM	629441.0	2	1000810	4014486472332
21	SHAFT 1306 MM (FROM NR. 09404033)	644419.0	2	1000832	4014486472585
21	SHAFT 1463 MM (FROM NR. 0940433)	661301.0	2	1000840	4014486472684
21	SHAFT 1463 MM (FROM NR. 0940433)	661301.1	2	1000840	4014486472684
22	COUNTERSHAFT DRIVE	603380.0	1	1001080	4014486498240
23		609762.0	1	1001713	4014486486919
24		506671.0	1	1000506	4014486467840
24		506671.1	1	1000506	4014486467840
24		506671.2	1	1000506	4014486467840
25		623427.0	1	1000410	4014486466737
27	STRAW CHOPPER DRIVE	060306.0	1	1000723	4014486471151
30		603341.0	1	1003328	4014486463217
30		783430.0	1	1000238	4014486463422
30		783430.1	1	1000238	4014486463422
32	FROM NR. 09405335	661345.0	1	1000160	4014486461824

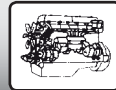

## CLAAS

32	FOR RABA - ENGINE	783876.0	1	1002091	4014486475845
32	TO NR. 09405334	821734.2	1	1000154	4014486461763
33	FOR 6.0 M - 9.0 M	670224.0	1	1001158	4014486497380
33	FOR 6.0 M - 9.0 M	670224.1	1	1001158	4014486497380
35	FOR RABA - ENGINE	629764.0	1	1000097	4014486460964
35	FOR OM 366 LA	657793.0	1	1000107	4014486461114
35	FOR OM 366 LA	661244.0	1	1000125	4014486461374
35	FOR MERCEDES ENGINE OM 441 A	661245.0	1	1003377	4014486461435
36	CHOPPER DRIVE (MAIZE)	061214.0	1	1000868	4014486473070
36	CHOPPER DRIVE (GRAIN) (FROM NR. 09403058)	061353.0	1	1000870	4014486473094
36	CHOPPER DRIVE (GRAIN) (FROM NR. 09403058)	061353.1	1	1000870	4014486473094
36	CHOPPER DRIVE (GRAIN) (TO NR. 09403057)	061360.0	1	1000870	4014486473094
36	CHOPPER DRIVE (GRAIN) (TO NR. 09403057)	061360.1	1	1000870	4014486473094
37	FROM NR. 09403058	609823.0	1	1001225	4014486497809
37	TO NR. 09403057	629035.0	1	1001289	4014486520545
38	FOR N=650-1500 RPM	603354.0	1	1001844	4014486488739
38	FOR N=510-1220 RPM	629510.0	1	1003634	4014486488623
38	FOR N=510-1220 RPM	629510.1	1	1003634	4014486488623
38	VAR. 7818	661298.0	1	1001630	4014486485738
41		695610.0	1	No AP	
42		680334.0	1	1001819	4014486488364
42		680334.1	1	1001819	4014486488364
43	FOR AIR EXHAUST	644448.0	1	1000139	4014486461565
	SHAFT 1463 MM (TO NR. 09404032)	603017.2	2	1000833	4014486472592
	COUNTERSHAFT DRIVE	603380.1	1	1001080	4014486498240
	SHAFT 1306 MM (TO NR. 09404032)	603430.1	2	1000823	4014486472493
		623427.1	1	1000409	4014486466720
	TO NR. 09403057	629000.1	1	1003661	4014486490657
	SHAFT BASE 1177 MM	629441.1	2	1000810	4014486472332
	TO NR. 09404032	629732.1	1	1000416	4014486466799
	NOT AT SERIES MAXI	640653.1	1	1000350	4014486466065
	SHAFT 1306 MM (FROM NR. 09404033)	644419.1	2	1000832	4014486472585

## DOMINATOR 108 MECH

0	COUNTERSHAFT DRIVE	060306.2	1	1000723	4014486471151
0	COUNTERSHAFT DRIVE	060306.3	1	No AP	
0	ELEVATOR DRIVE UNIT	629732.2	1	1000417	4014486520507
1		689175.0	1	1003391	4014486462654
2		629908.0	1	1002332	4014486478631
2		629908.1	1	1002332	4014486478631
3		629769.0	1	1002699	4014486484922
3		629769.1	1	1002699	4014486484922
4	MAIN/DRUM	629000.0	1	1003661	4014486490657
5		603337.0	1	1000662	4014486470260
6	RETURN AUGER DRIVE	603336.0	1	1000478	4014486467499
6	RETURN AUGER DRIVE	603336.1	1	1000478	4014486467499
7	ELEVATOR DRIVE UNIT	629732.0	1	1000415	4014486466782
7	FROM NR. 09404033	644447.0	1	1000420	4014486466836
8		640653.0	1	1000350	4014486466065
11	FOR 3.9 M - 5.1 M	670224.0	1	1001158	4014486497380
12	FOR 3.9 M - 5.1 M	670224.1	1	1001158	4014486497380
13	FOR MAIZE PICKER	692149.0	1	1001852	4014486488869
13	FOR MAIZE PICKER	692150.0	1	1001857	4014486488920
16	FOR 6.0 M - 9.0 M	671013.0	1	1000674	4014486470468
17	FOR 6.0 M - 9.0 M	671013.1	1	1000676	4014486470482

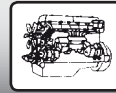
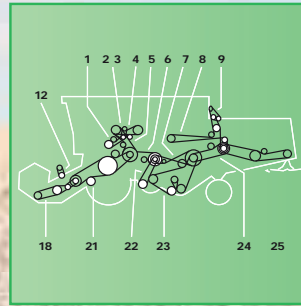
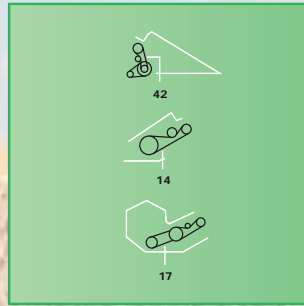
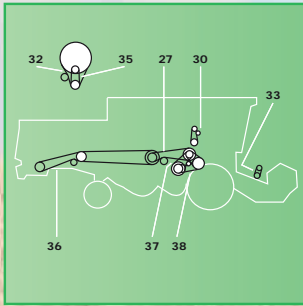

## CLAAS

18	FOR 3.9 M - 5.1 M	713506.0	1	1000315	4014486465310
18	FOR 3.9 M - 5.1 M	713506.1	1	1000315	4014486465310
18	FOR 3.9 M - 5.1 M	713506.2	1	1000315	4014486465310
20	SHAFT 1306 MM	603290.0		1000764	4014486471670
20	SHAFT BASE 1177 MM	629836.0	1	1000746	4014486471427
21	TABLE CLUTCH	673638.0	1	1001099	4014486496819
22		609822.0	1	1001854	4014486488890
23		609823.0	1	1001225	4014486497809
24		603380.0	1	1001080	4014486498240
24		661220.0	1	1003340	4014486488807
25		609762.0	1	1001713	4014486486919
26		506671.0	1	1000506	4014486467840
26		506671.1	1	1000506	4014486467840
26		506671.2	1	1000506	4014486467840
27		623427.0	1	1000410	4014486466737
29	COUNTERSHAFT DRIVE	060306.0	1	1000723	4014486471151
32	TO NR. 09400750	603341.0	1	1003328	4014486463217
32	FROM NR. 09400751	783430.0	1	1000238	4014486463422
32	FROM NR. 09400751	783430.1	1	1000238	4014486463422
33	FOR 6.0 M - 9.0 M	670224.1	1	1001158	4014486497380
34	FOR 6.0 M - 9.0 M	670224.0	1	1001158	4014486497380
36	CHOPPER DRIVE (MAIZE)	061214.0	1	1000868	4014486473070
36	CHOPPER DRIVE (GRAIN) (FROM NR. 09403058)	061353.0	1	1000870	4014486473094
36	CHOPPER DRIVE (GRAIN) (FROM NR. 09403058)	061353.1	1	1000870	4014486473094
36	CHOPPER DRIVE (GRAIN) (TO NR. 09403057)	061360.0	1	1000870	4014486473094
36	CHOPPER DRIVE (GRAIN) (TO NR. 09403057)	061360.1	1	1000870	4014486473094
37		628630.0	1	1001208	4014486497670
40		695610.0	1	No AP	
41		680334.0	1	1001819	4014486488364
41		680334.1	1	1001819	4014486488364
		603380.1	1	1001080	4014486498240
		623427.1	1	1000409	4014486466720
	MAIN/DRUM	629000.1	1	1003661	4014486490657
	ELEVATOR DRIVE UNIT	629732.1	1	1000416	4014486466799
	SHAFT BASE 1177 MM	629836.1	2	1003819	4014486518870
		640653.1	1	1000350	4014486466065
	FOR TWO-STAGE DRIVE	661220.1	1	1003340	4014486488807
	TABLE CLUTCH	673638.1	1	1001099	4014486496819

## DOMINATOR 108 VX

0		060306.2	1	1000723	4014486471151
0		060306.4	1	1000723	4014486471151
0		506671.0	1	1000506	4014486467840
0		506671.1	1	1000506	4014486467840
0		755070.0	2	1002795	4014486463279
0		755070.2	2	1002795	4014486463279
1		544049.0	1	1001939	4014486490367
2		767057.1	1	1003333	4014486462609
3		629908.0	1	1002332	4014486478631
3		629908.1	1	1002332	4014486478631
4		660409.0	1	1001575	4014486484809
5		644404.0	1	1003354	4014486490763
5		644404.1	1	1003354	4014486490763
6		603337.0	1	1000662	4014486470260
7		644141.1	1	1000476	4014486467475



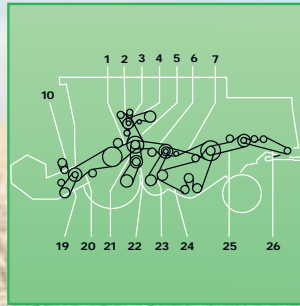
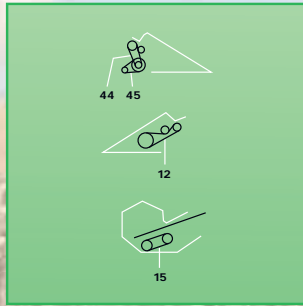
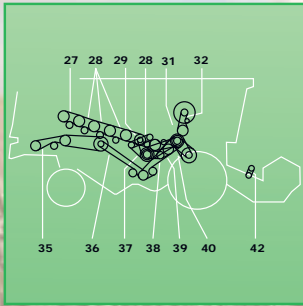

# CLAAS

8		644447.0	1	1000420	4014486466836
9		623427.1	1	1000409	4014486466720
10		755070.1	2	1002795	4014486463279
11		066034.0	1	1000302	4014486465037
11		785341.0	1	1000295	4014486464870
12		661337.0	2	1000845	4014486472745
12		661337.1	2	1000845	4014486472745
13		061214.0	1	1000868	4014486473070
13		061353.0	1	1000870	4014486473094
13		061353.1	1	1000870	4014486473094
14		603380.1	1	1001080	4014486498240
15		609762.0	1	1001713	4014486486919
17		060306.3	1	No AP	
19		506671.2	1	1000506	4014486467840
20		661345.0	1	1000160	4014486461824
21	MERCEDES ENGINE OM 366L	661244.0	1	1000125	4014486461374
21	MERCEDES ENGINE OM 441	661245.0	1	1003377	4014486461435
22		644448.0	1	1000139	4014486461565
23		609823.0	1	1001225	4014486497809
24		661220.1	1	1003340	4014486488807
24		661298.0	1	1001630	4014486485738
		544049.1	2	1001561	4014486484618

## DOMINATOR 112

0	FOR STRAW CHOPPER	061700.1	1	1003356	4014486486131
0	FOR SOJA CUTTING TABLE	644209.2	1	1004843	4014486715668
1		673638.1	1	1001099	4014486496819
2		689175.0	1	1003391	4014486462654
3		629908.0	1	1002332	4014486478631
3		629908.1	1	1002332	4014486478631
4		629769.0	1	1002699	4014486484922
4		629769.1	1	1002699	4014486484922
5		629000.0	1	1003661	4014486490657
6		603337.0	1	1000662	4014486470260
7		644141.0	1	1000476	4014486467475
7		644141.1	1	1000476	4014486467475
12	FOR MAIZE PICKER	692149.0	1	1001852	4014486488869
12	FOR MAIZE PICKER	692150.0	1	1001857	4014486488920
15	FOR SOJA CUTTING TABLE	644209.0	1	1000699	4014486470826
15	FOR SOJA CUTTING TABLE	644209.1	1	1004843	4014486715668
15	FROM 6.0 M CUTTING TABLE	671013.1	1	1000676	4014486470482
19	TO 5.1 M CUTTING TABLE	629214.1	1	1002317	4014486480054
20		629836.0	1	1000746	4014486471427
21		609822.0	1	1001854	4014486488890
22		609823.0	1	1001225	4014486497809
23		603380.0	1	1001080	4014486498240
24		609762.0	1	1001713	4014486486919
25		506671.0	1	1000506	4014486467840
25		506671.1	1	1000506	4014486467840
25		506671.2	1	1000506	4014486467840
26		640653.1	1	1000350	4014486466065
27		644014.0	1	1002319	4014486480078
27		644014.1	1	1002319	4014486480078
28		644015.0	1	1002913	4014486484601
29		644016.1	1	1001800	4014486488104

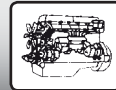
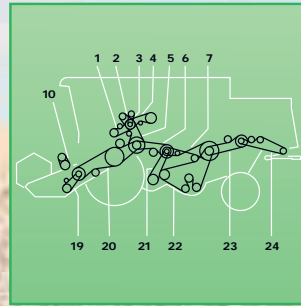
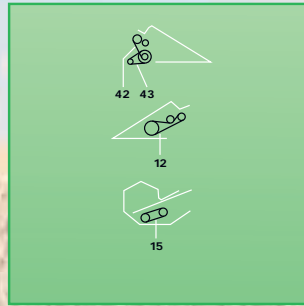
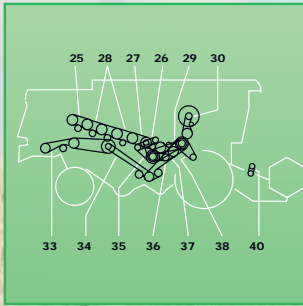

## CLAAS

31		064168.0	1	1003635	4014486488753
31		064168.1	1	1003635	4014486488753
31		064168.2	1	1003635	4014486488753
35	FOR GRAIN	061701.1	1	1000790	4014486472066
35	FOR GRAIN	061701.2	1	1000790	4014486472066
35	FOR MAIZE	061872.0	2	1002867	4014486471939
36	FOR STRAW CHOPPER	061700.0	1	1003356	4014486486131
37		603247.1	1	1003626	4014486488111
38		061700.0	1	1003356	4014486486131
40	CYLINDER N=650-1500 RPM	603015.1	1	1001503	4014486460186
40	CYLINDER N=500-1400 RPM	644177.0	1	1001221	4014486497762
42	FROM 6.0 M CUTTING TABLE	670224.0	1	1001158	4014486497380
44		680334.0	1	1001819	4014486488364
44		680334.1	1	1001819	4014486488364
45		629410.0	2	1002872	4014486468441
		603380.1	1	1001080	4014486498240
		629000.1	1	1003661	4014486490657
		629410.1	2	1002872	4014486468441
		629836.1	2	1003819	4014486518870
		644015.1	1	1002913	4014486484601
	FROM 6.0 M CUTTING TABLE	670224.1	1	1001158	4014486497380

## DOMINATOR 114

0	FOR STRAW CHOPPER	061700.1	1	1003356	4014486486131
0		603017.0	2	1000833	4014486472592
0	FOR SOJA CUTTING TABLE	644209.2	1	1004843	4014486715668
1		629279.0	1	1001936	4014486490336
2		629002.0	1	1003395	4014486462715
2		629002.1	1	1003395	4014486462715
3	TO NR. 14200046	621903.0	1	1002041	4014486475166
3	TO NR. 14200046	621903.1	1	1002041	4014486475166
3	FROM NR. 14200047	629908.0	1	1002332	4014486478631
3	FROM NR. 14200047	629908.1	1	1002332	4014486478631
4		629763.0	1	1003593	4014486484977
5		629000.0	1	1003661	4014486490657
6		603337.0	1	1000662	4014486470260
7		644141.0	1	1000476	4014486467475
7		644141.1	1	1000476	4014486467475
10	TO 5.7 M CUTTING TABLE	670224.0	1	1001158	4014486497380
12	FOR MAIZE PICKER	692149.0	1	1001852	4014486488869
12	FOR MAIZE PICKER	692150.0	1	1001857	4014486488920
15	FOR SOJA CUTTING TABLE	644209.0	1	1000699	4014486470826
15	FOR SOJA CUTTING TABLE	644209.1	1	1004843	4014486715668
15	FROM 6.0 M CUTTING TABLE	671013.1	1	1000676	4014486470482
19	TO 5.7 M CUTTING TABLE	629214.1	1	1002317	4014486480054
20		603017.3	2	1000833	4014486472592
21		603380.0	1	1001080	4014486498240
22		609762.0	1	1001713	4014486486919
23	FOR STRAW DISTRIBUTOR	506671.0	1	1000506	4014486467840
23	FOR STRAW DISTRIBUTOR	506671.1	1	1000506	4014486467840
23	FOR STRAW DISTRIBUTOR	506671.2	1	1000506	4014486467840
24	FOR STRAW DISTRIBUTOR	640653.1	1	1000350	4014486466065
26		644015.1	1	1002913	4014486484601
27		644016.1	1	1001800	4014486488104
29		064168.0	1	1003635	4014486488753

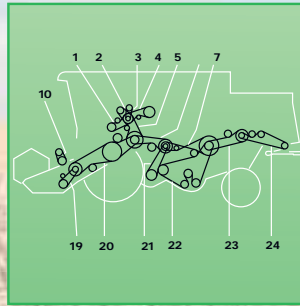
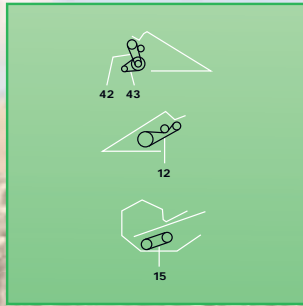
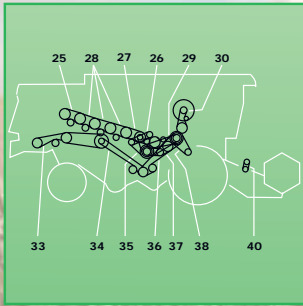

# CLAAS

29		064168.1	1	1003635	4014486488753
29		064168.2	1	1003635	4014486488753
30	FROM NR. 14200177	233843.1	1	1000237	4014486463408
30	TO NR. 14200176	603341.0	1	1003328	4014486463217
33	FOR GRAIN	061701.1	1	1000790	4014486472066
33	FOR GRAIN	061701.2	1	1000790	4014486472066
33	FOR MAIZE	061872.0	2	1002867	4014486471939
34	FOR STRAW CHOPPER	061700.0	1	1003356	4014486486131
35		603247.1	1	1003626	4014486488111
36		061700.0	1	1003356	4014486486131
37		644014.0	1	1002319	4014486480078
38	CYLINDER N=650-1500 RPM	603015.1	1	1001503	4014486460186
38	CYLINDER N=500-1400 RPM	644177.0	1	1001221	4014486497762
40	FROM 6.0 M CUTTING TABLE	670224.0	1	1001158	4014486497380
42		680334.0	1	1001819	4014486488364
42		680334.1	1	1001819	4014486488364
43		629410.0	2	1002872	4014486468441
		603017.2	2	1000833	4014486472592
		603380.1	1	1001080	4014486498240
		629000.1	1	1003661	4014486490657
		629410.1	2	1002872	4014486468441
		644014.1	1	1002319	4014486480078
	FROM 6.0 M CUTTING TABLE	670224.1	1	1001158	4014486497380
	TO 5.7 M CUTTING TABLE	670224.1	1	1001158	4014486497380

# DOMINATOR 115

0	FOR STRAW CHOPPER	061700.1	1	1003356	4014486486131
0		603017.0	2	1000833	4014486472592
0	FOR SOJA CUTTING TABLE	644209.2	1	1004843	4014486715668
1		629763.0	1	1003593	4014486484977
1		644017.0	1	1001236	4014486491906
2		629002.0	1	1003395	4014486462715
2		629002.1	1	1003395	4014486462715
3		629908.0	1	1002332	4014486478631
3		629908.1	1	1002332	4014486478631
5		644018.0	1	1001243	4014486491982
6		603337.0	1	1000662	4014486470260
7		644141.0	1	1000476	4014486467475
7		644141.1	1	1000476	4014486467475
10	TO 5.1 M CUTTING TABLE	670224.0	1	1001158	4014486497380
12	FOR MAIZE PICKER	692149.0	1	1001852	4014486488869
12	FOR MAIZE PICKER	692150.0	1	1001857	4014486488920
15	FOR SOJA CUTTING TABLE	644209.0	1	1000699	4014486470826
15	FOR SOJA CUTTING TABLE	644209.1	1	1004843	4014486715668
15	FROM 6.0 M CUTTING TABLE	671013.1	1	1000676	4014486470482
19	TO 5.1 M CUTTING TABLE	629214.1	1	1002317	4014486480054
20		603017.3	2	1000833	4014486472592
21		603380.0	1	1001080	4014486498240
22		609762.0	1	1001713	4014486486919
23	FOR STRAW DISTRIBUTOR	506671.0	1	1000506	4014486467840
23	FOR STRAW DISTRIBUTOR	506671.1	1	1000506	4014486467840
23	FOR STRAW DISTRIBUTOR	506671.2	1	1000506	4014486467840
24	FOR STRAW DISTRIBUTOR	640653.1	1	1000350	4014486466065
26		644015.1	1	1002913	4014486484601
27		644016.1	1	1001800	4014486488104

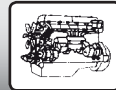
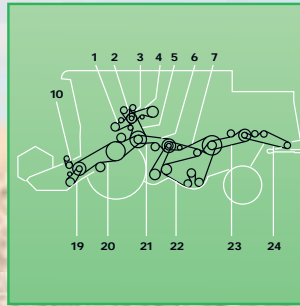
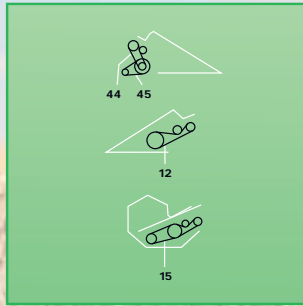
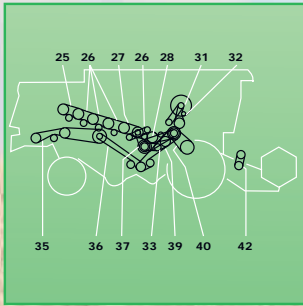

## CLAAS

29		064168.0	1	1003635	4014486488753
29		064168.1	1	1003635	4014486488753
29		064168.2	1	1003635	4014486488753
30		233843.1	1	1000237	4014486463408
33	FOR GRAIN	061701.1	1	1000790	4014486472066
33	FOR GRAIN	061701.2	1	1000790	4014486472066
33	FOR MAIZE	061872.0	2	1002867	4014486471939
34	FOR STRAW CHOPPER	061700.0	1	1003356	4014486486131
35		603247.1	1	1003626	4014486488111
36		061700.0	1	1003356	4014486486131
37		644014.0	1	1002319	4014486480078
37		644014.1	1	1002319	4014486480078
38	CYLINDER N=650-1500 RPM	603015.1	1	1001503	4014486460186
38	CYLINDER N=500-1400 RPM	644177.0	1	1001221	4014486497762
40	FROM 6.0 M CUTTING TABLE	670224.0	1	1001158	4014486497380
42		680334.0	1	1001819	4014486488364
42		680334.1	1	1001819	4014486488364
43		629410.0	2	1002872	4014486468441
		603017.2	2	1000833	4014486472592
		603380.1	1	1001080	4014486498240
		629410.1	2	1002872	4014486468441
		644017.1	1	1001236	4014486491906
		644018.1	1	1001243	4014486491982
	FROM 6.0 M CUTTING TABLE	670224.1	1	1001158	4014486497380
	TO 5.1 M CUTTING TABLE	670224.1	1	1001158	4014486497380

## DOMINATOR 116

0	FOR STRAW CHOPPER	061700.1	1	1003356	4014486486131
0	TABLE (FROM NR. 14400125)	603017.0	2	1000833	4014486472592
0	FROM NR. 14400300	633030.0	1	1000220	4014486462838
0	FOR SOJA CUTTING TABLE	644209.2	1	1004843	4014486715668
1	HYDRAULIC PUMP DRIVE	644017.0	1	1001236	4014486491906
2	HYDRAULIC PUMP DRIVE (FROM NR. 14400300)	629002.0	1	1003395	4014486462715
2	HYDRAULIC PUMP DRIVE (FROM NR. 14400300)	629002.1	1	1003395	4014486462715
2	HYDRAULIC PUMP DRIVE (TO NR. 14400299)	689175.0	1	1003391	4014486462654
3	TO NR. 14400199	621903.0	1	1002041	4014486475166
3	TO NR. 14400199	621903.1	1	1002041	4014486475166
3	FROM NR. 14400200	629908.0	1	1002332	4014486478631
3	FROM NR. 14400200	629908.1	1	1002332	4014486478631
4	DRIVE GRAIN TANK	629763.0	1	1003593	4014486484977
5	MAIN DRIVE	644018.0	1	1001243	4014486491982
6		603337.0	1	1000662	4014486470260
7	RETURN AUGER DRIVE	603336.0	1	1000478	4014486467499
7	RETURN AUGER DRIVE	603336.1	1	1000478	4014486467499
10	REEL DRIVE VARIABLE SPEED - TO 5.7 M CUTTING TABLE	670224.0	1	1001158	4014486497380
10	REEL DRIVE VARIABLE SPEED - TO 5.7 M CUTTING TABLE	670224.1	1	1001158	4014486497380
12	FOR MAIZE PICKER	692149.0	1	1001852	4014486488869
12	FOR MAIZE PICKER	692150.0	1	1001857	4014486488920
15	FOR SOJA CUTTING TABLE	644209.0	1	1000699	4014486470826
15	FOR SOJA CUTTING TABLE	644209.1	1	1004843	4014486715668
15	FROM 6.0 M CUTTING TABLE	671013.1	1	1000676	4014486470482
19	KNIFE TO 5.7 M CUTTING TABLE	629214.1	1	1002317	4014486480054
20	TABLE (FROM NR. 14400125)	603017.3	2	1000833	4014486472592
20	TABLE (TO NR. 14400124)	629441.0	2	1000810	4014486472332
21		603380.0	1	1001080	4014486498240

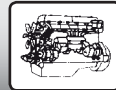

## CLAAS

22	SIEVE PAN DRIVE	609762.0	1	1001713	4014486486919
23	STRAW WALKER DRIVE	506671.0	1	1000506	4014486467840
23	STRAW WALKER DRIVE	506671.1	1	1000506	4014486467840
23	STRAW WALKER DRIVE	506671.2	1	1000506	4014486467840
24		640653.1	1	1000350	4014486466065
26	ROLLER	644015.1	1	1002913	4014486484601
27	ROLLER	644016.1	1	1001800	4014486488104
28	INTERMEDIATE SHAFT	064168.0	1	1003635	4014486488753
28	INTERMEDIATE SHAFT	064168.1	1	1003635	4014486488753
28	INTERMEDIATE SHAFT	064168.2	1	1003635	4014486488753
31	SCREEN (TO NR. 14400299)	233843.1	1	1000237	4014486463408
31	SCREEN (FROM NR. 14400300)	644267.0	1	1000243	4014486463613
32	FROM NR. 14400300	633030.2	1	1000220	4014486462838
35	FOR GRAIN	061701.1	1	1000790	4014486472066
35	FOR GRAIN	061701.2	1	1000790	4014486472066
35	FOR MAIZE	061872.0	2	1002867	4014486471939
36	FOR STRAW CHOPPER	061700.0	1	1003356	4014486486131
37	STRAW WALKER DRIVE	603247.1	1	1003626	4014486488111
38		061700.0	1	1003356	4014486486131
39		644014.0	1	1002319	4014486480078
39		644014.1	1	1002319	4014486480078
40	CYLINDER N=650-1500 RPM	603015.1	1	1001503	4014486460186
40	CYLINDER N=500-1400 RPM	644177.0	1	1001221	4014486497762
42	FROM 6.0 M CUTTING TABLE	670224.0	1	1001158	4014486497380
44		680334.0	1	1001819	4014486488364
44		680334.1	1	1001819	4014486488364
45		629410.0	2	1002872	4014486468441
	TABLE (FROM NR. 14400125)	603017.2	2	1000833	4014486472592
		603380.1	1	1001080	4014486498240
		629410.1	2	1002872	4014486468441
	TABLE (TO NR. 14400124)	629441.1	2	1000810	4014486472332
	FROM NR. 14400300	633030.1	1	1000220	4014486462838
	HYDRAULIC PUMP DRIVE	644017.1	1	1001236	4014486491906
	MAIN DRIVE	644018.1	1	1001243	4014486491982
	FROM 6.0 M CUTTING TABLE	670224.1	1	1001158	4014486497380

## DOMINATOR 118

0		060306.2	1	1000723	4014486471151
0		060306.4	1	1000723	4014486471151
0		506671.0	1	1000506	4014486467840
0		506671.1	1	1000506	4014486467840
0	TO NO. 09404032	603017.0	2	1000833	4014486472592
0	TO NO. 09404032	629732.0	1	1000415	4014486466782
0	TO NO. 09404032	629732.1	1	1000416	4014486466799
0	AT MERCEDES OM 421 A	633030.0	1	1000220	4014486462838
1	AT MERCEDES OM 421	629279.0	1	1001936	4014486490336
1	AT MERCEDES OM 441 A 163 KW 4 GROOVE	644405.2	1	1001941	4014486490411
1	AT MERCEDES OM 441 A	661092.1	1	1001238	4014486491920
2	AT MERCEDES OM 441 A	633030.2	1	1000220	4014486462838
2		689175.0	1	1003391	4014486462654
2	HYDRAULIC PUMP 163 KW 4 GROOVE	767057.1	1	1003333	4014486462609
2	HYDRAULIC PUMP AT MERCEDES OM 366 LA	767057.1	1	1003333	4014486462609
3		629908.0	1	1002332	4014486478631
3		629908.1	1	1002332	4014486478631
3	AT MERCEDES OM 441 A	661114.0	1	1002336	4014486478686

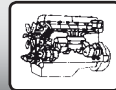

## CLAAS

4	AT MERCEDES OM 421	629763.0	1	1003593	4014486484977
4	AT RABA - MOTOR	629763.0	1	1003593	4014486484977
4	AT MERCEDES OM 366 LA WITH MECHANICAL GROUND DRIVE	629769.0	1	1002699	4014486484922
4	AT PERKINS V8 540	629769.0	1	1002699	4014486484922
4	AT MERCEDES OM 366 LA WITH MECHANICAL GROUND DRIVE	629769.1	1	1002699	4014486484922
4	AT PERKINS V8 540	629769.1	1	1002699	4014486484922
4	AT MERCEDES OM 366 LA WITH HYDRAULIC GROUND DRIVE	660409.0	1	1001575	4014486484809
4	AT MERCEDES OM 441 A	661093.0	1	1001581	4014486484885
5	TO NO. 094030057	629000.1	1	1003661	4014486490657
5	AT 5 - RILL DRIVE FROM 09403058	644403.0	1	1001247	4014486492033
5	AT 4 - RILL DRIVE FROM NO. 09403058	644404.0	1	1003354	4014486490763
5	AT 4 - RILL DRIVE FROM NO. 09403058	644404.1	1	1003354	4014486490763
6		603337.0	1	1000662	4014486470260
7		603336.0	1	1000478	4014486467499
7		603336.1	1	1000478	4014486467499
8	TO NO. 09404032	629732.2	1	1000417	4014486520507
8	FROM NO. 09404033	644447.0	1	1000420	4014486466836
9	NOT AT SERIES MAXI	640653.1	1	1000350	4014486466065
12	AT 3.9 M - 5.1 M	670224.1	1	1001158	4014486497380
14	FOR CORN PICKER	692149.0	1	1001852	4014486488869
14	FOR CORN PICKER	692150.0	1	1001857	4014486488920
17	AT 6.0 M - 9M	671013.1	1	1000676	4014486470482
19	AT 3.9 M - 5.1 M	713506.0	1	1000315	4014486465310
19	AT 3.9 M - 5.1 M	713506.1	1	1000315	4014486465310
19	AT 3.9 M - 5.1 M	713506.2	1	1000315	4014486465310
21	TO NO. 09404032	603017.3	2	1000833	4014486472592
21	TO NO. 0904032	603430.0	2	1000823	4014486472493
21	SHAFTS DISTANCE 1177 MM	629441.0	2	1000810	4014486472332
21	SHAFTS DISTANCE 1306 MM FROM NO. 09404033	644419.0	2	1000832	4014486472585
21	SHAFTS DISTANCE 1463 MM FROM NO. 09404033	661301.0	2	1000840	4014486472684
21	SHAFTS DISTANCE 1463 MM FROM NO. 09404033	661301.1	2	1000840	4014486472684
22		603380.1	1	1001080	4014486498240
23		609762.0	1	1001713	4014486486919
24		506671.2	1	1000506	4014486467840
25		623427.1	1	1000409	4014486466720
27		060306.3	1	No AP	
30	ROTARY SCREEN AT MERCEDES - MOTOR TO NO. 09400750	603341.0	1	1003328	4014486463217
30	AT MERCEDES - MOTOR FROM 09400751 - 09403057	783430.0	1	1000238	4014486463422
30	AT MERCEDES - MOTOR FROM 09400751 - 09403057	783430.1	1	1000238	4014486463422
32	FROM NO. 09405335	661345.0	1	1000160	4014486461824
32	AT RABA - MOTOR	783876.0	1	1002091	4014486475845
32	TO NO. 09405334	821734.2	1	1000154	4014486461763
33	AT 6.0 M - 9M	670224.1	1	1001158	4014486497380
35	AT RABA - MOTOR	629764.0	1	1000097	4014486460964
35	AT OM 366 LA 132 KW	657793.0	1	1000107	4014486461114
35	AT OM 366 LA 163 KW	661244.0	1	1000125	4014486461374
35	AT MERCEDES OM 441 A	661245.0	1	1003377	4014486461435
36	FOR CORN - CHOPPER	061214.0	1	1000868	4014486473070
36	FOR GRAIN CHOPPER FROM NO. 09403058	061353.0	1	1000870	4014486473094
36	FOR GRAIN CHOPPER FROM NO. 09403058	061353.1	1	1000870	4014486473094
36	FOR GRAIN CHOPPER TO NO. 09403057	061360.0	1	1000870	4014486473094
36	FOR GRAIN CHOPPER TO NO. 09403057	061360.1	1	1000870	4014486473094
37	FROM NO. 09403058	609823.0	1	1001225	4014486497809
37	TO NO. 09403057	629035.0	1	1001289	4014486520545
38	AT N 650 - 1500 MIN-1 TO 09403057	603354.0	1	1001844	4014486488739

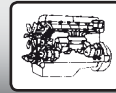
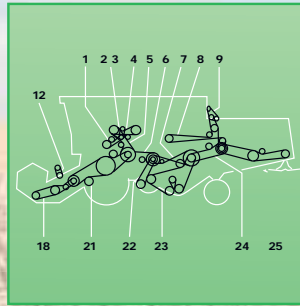
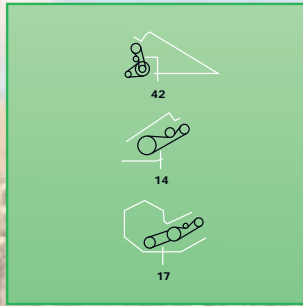
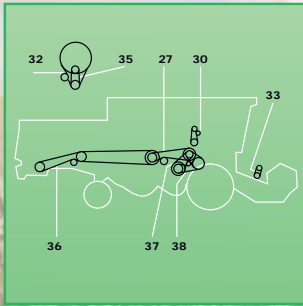

## CLAAS

38	AT N 510 - 1220 MIN-1 TO 09403057	629510.0	1	1003634	4014486488623
38	AT N 510 - 1220 MIN-1 TO 09403057	629510.1	1	1003634	4014486488623
38	VAR. 7693 / VAR. 7716 3 GROOVE	661220.0	1	1003340	4014486488807
38	VAR. 7693 / VAR. 7716 3 GROOVE	661220.1	1	1003340	4014486488807
38	VAR. 7818 2 GROOVE	661298.0	1	1001630	4014486485738
41	FOR HPH - G CHOPPER	695610.0	1	No AP	
42	FOR HPH - G CHOPPER	680334.0	1	1001819	4014486488364
42	FOR HPH - G CHOPPER	680334.1	1	1001819	4014486488364
43	FOR SUCTION BLOWER	644448.0	1	1000139	4014486461565
	TO NO. 09404032	603017.2	2	1000833	4014486472592
	TO NO. 0904032	603430.1	2	1000823	4014486472493
	SHAFTS DISTANCE 1177 MM	629441.1	2	1000810	4014486472332
	AT MERCEDES OM 441 A	633030.1	1	1000220	4014486462838
	AT MERCEDES OM 441 A 163 KW 4 GROOVE	644405.1	1	1001941	4014486490411
	SHAFTS DISTANCE 1306 MM FROM NO. 09404033	644419.1	2	1000832	4014486472585

## DOMINATOR 118 HYDR

0	STRAW CHOPPER DRIVE	060306.2	1	1000723	4014486471151
0	STRAW CHOPPER DRIVE	060306.3	1	No AP	
0	SHAFT 1463 MM (TO NR. 09404032)	603017.3	2	1000833	4014486472592
0	TO NR. 09404032	629732.2	1	1000417	4014486520507
0	VAR. 7693 / VAR. 7716	661220.0	1	1003340	4014486488807
0	VAR. 7693 / VAR. 7716	661220.1	1	1003340	4014486488807
1	FOR MERCEDES ENGINE OM 421	629279.0	1	1001936	4014486490336
1	FOR MERCEDES ENGINE OM 366 LA	644405.1	1	1001941	4014486490411
1	FOR MERCEDES ENGINE OM 366 LA	644405.2	1	1001941	4014486490411
1	FOR MERCEDES ENGINE OM 441 A	661092.1	1	1001238	4014486491920
2		689175.0	1	1003391	4014486462654
3		629908.0	1	1002332	4014486478631
3		629908.1	1	1002332	4014486478631
3	FOR VAR. 7705	661114.0	1	1002336	4014486478686
4	TO NR. 09403057	629763.0	1	1003593	4014486484977
4	FOR VAR. 7605	660409.0	1	1001575	4014486484809
4	FOR VAR. 7705	661093.0	1	1001581	4014486484885
5	TO NR. 09403057	629000.0	1	1003661	4014486490657
5	FROM NR. 09403058	644404.0	1	1003354	4014486490763
5	FROM NR. 09403058	644404.1	1	1003354	4014486490763
6		603337.0	1	1000662	4014486470260
7		603336.0	1	1000478	4014486467499
7		603336.1	1	1000478	4014486467499
8	TO NR. 09404032	629732.0	1	1000415	4014486466782
8	FROM NR. 09404033	644447.0	1	1000420	4014486466836
9	NOT AT SERIES MAXI	640653.0	1	1000350	4014486466065
12	FOR 3.9 M - 5.1 M	670224.0	1	1001158	4014486497380
12	FOR 3.9 M - 5.1 M	670224.1	1	1001158	4014486497380
14	FOR MAIZE PICKER	692149.0	1	1001852	4014486488869
14	FOR MAIZE PICKER	692150.0	1	1001857	4014486488920
17	FOR 6.0 M - 9.0 M	671013.0	1	1000674	4014486470468
17	FOR 6.0 M - 9.0 M	671013.1	1	1000676	4014486470482
19	STRAW WALKER DRIVE	713506.0	1	1000315	4014486465310
19	STRAW WALKER DRIVE	713506.1	1	1000315	4014486465310
19	STRAW WALKER DRIVE	713506.2	1	1000315	4014486465310
21	SHAFT 1463 MM (TO NR. 09404032)	603017.0	2	1000833	4014486472592
21	SHAFT 1306 MM (TO NR. 09404032)	603430.0	2	1000823	4014486472493
21	SHAFT BASE 1177 MM	629441.0	2	1000810	4014486472332



## CLAAS

21	SHAFT 1306 MM (FROM NR. 09404033)	644419.0	2	1000832	4014486472585
21	SHAFT 1463 MM (FROM NR. 0940433)	661301.0	2	1000840	4014486472684
21	SHAFT 1463 MM (FROM NR. 0940433)	661301.1	2	1000840	4014486472684
22	COUNTERSHAFT DRIVE	603380.0	1	1001080	4014486498240
23		609762.0	1	1001713	4014486486919
24		506671.0	1	1000506	4014486467840
24		506671.1	1	1000506	4014486467840
24		506671.2	1	1000506	4014486467840
25		623427.0	1	1000410	4014486466737
27	STRAW CHOPPER DRIVE	060306.0	1	1000723	4014486471151
30		603341.0	1	1003328	4014486463217
30		783430.0	1	1000238	4014486463422
30		783430.1	1	1000238	4014486463422
32	FROM NR. 09405335	661345.0	1	1000160	4014486461824
32	FOR RABA - ENGINE	783876.0	1	1002091	4014486475845
32	TO NR. 09405334	821734.2	1	1000154	4014486461763
33	FOR 6.0 M - 9.0 M	670224.0	1	1001158	4014486497380
33	FOR 6.0 M - 9.0 M	670224.1	1	1001158	4014486497380
35	FOR RABA - ENGINE	629764.0	1	1000097	4014486460964
35	FOR OM 366 LA	657793.0	1	1000107	4014486461114
35	FOR OM 366 LA	661244.0	1	1000125	4014486461374
35	FOR MERCEDES ENGINE OM 441 A	661245.0	1	1003377	4014486461435
36	CHOPPER DRIVE (MAIZE)	061214.0	1	1000868	4014486473070
36	CHOPPER DRIVE (GRAIN) (FROM NR. 09403058)	061353.0	1	1000870	4014486473094
36	CHOPPER DRIVE (GRAIN) (FROM NR. 09403058)	061353.1	1	1000870	4014486473094
36	CHOPPER DRIVE (GRAIN) (TO NR. 09403057)	061360.0	1	1000870	4014486473094
36	CHOPPER DRIVE (GRAIN) (TO NR. 09403057)	061360.1	1	1000870	4014486473094
37	FROM NR. 09403058	609823.0	1	1001225	4014486497809
37	TO NR. 09403057	629035.0	1	1001289	4014486520545
38	FOR N=650-1500 RPM	603354.0	1	1001844	4014486488739
38	FOR N=510-1220 RPM	629510.0	1	1003634	4014486488623
38	FOR N=510-1220 RPM	629510.1	1	1003634	4014486488623
38	VAR. 7818	661298.0	1	1001630	4014486485738
41		695610.0	1	No AP	
42		680334.0	1	1001819	4014486488364
42		680334.1	1	1001819	4014486488364
43	FOR AIR EXHAUST	644448.0	1	1000139	4014486461565
	SHAFT 1463 MM (TO NR. 09404032)	603017.2	2	1000833	4014486472592
	COUNTERSHAFT DRIVE	603380.1	1	1001080	4014486498240
	SHAFT 1306 MM (TO NR. 09404032)	603430.1	2	1000823	4014486472493
		623427.1	1	1000409	4014486466720
	TO NR. 09403057	629000.1	1	1003661	4014486490657
	SHAFT BASE 1177 MM	629441.1	2	1000810	4014486472332
	TO NR. 09404032	629732.1	1	1000416	4014486466799
	NOT AT SERIES MAXI	640653.1	1	1000350	4014486466065
	SHAFT 1306 MM (FROM NR. 09404033)	644419.1	2	1000832	4014486472585

### DOMINATOR 118 MECH

0	COUNTERSHAFT DRIVE	060306.2	1	1000723	4014486471151
0	COUNTERSHAFT DRIVE	060306.3	1	No AP	
0	ELEVATOR DRIVE UNIT	629732.2	1	1000417	4014486520507
0	FOR TWO-STAGE DRIVE	661220.0	1	1003340	4014486488807
1		689175.0	1	1003391	4014486462654
2		629908.0	1	1002332	4014486478631
2		629908.1	1	1002332	4014486478631





## CLAAS

3		629769.0	1	1002699	4014486484922
3		629769.1	1	1002699	4014486484922
4	MAIN/DRUM	629000.0	1	1003661	4014486490657
5		603337.0	1	1000662	4014486470260
6	RETURN AUGER DRIVE	603336.0	1	1000478	4014486467499
6	RETURN AUGER DRIVE	603336.1	1	1000478	4014486467499
7	ELEVATOR DRIVE UNIT	629732.0	1	1000415	4014486466782
7	FROM NR. 09404033	644447.0	1	1000420	4014486466836
8		640653.0	1	1000350	4014486466065
11	FOR 3.9 M - 5.1 M	670224.0	1	1001158	4014486497380
12	FOR 3.9 M - 5.1 M	670224.1	1	1001158	4014486497380
13	FOR MAIZE PICKER	692149.0	1	1001852	4014486488869
13	FOR MAIZE PICKER	692150.0	1	1001857	4014486488920
16	FOR 6.0 M - 9.0 M	671013.0	1	1000674	4014486470468
17	FOR 6.0 M - 9.0 M	671013.1	1	1000676	4014486470482
18	FOR 3.9 M - 5.1 M	713506.0	1	1000315	4014486465310
18	FOR 3.9 M - 5.1 M	713506.1	1	1000315	4014486465310
18	FOR 3.9 M - 5.1 M	713506.2	1	1000315	4014486465310
20	SHAFT 1306 MM	603290.0		1000764	4014486471670
20	SHAFT BASE 1177 MM	629836.0	1	1000746	4014486471427
21	TABLE CLUTCH	673638.0	1	1001099	4014486496819
22		609822.0	1	1001854	4014486488890
23		609823.0	1	1001225	4014486497809
24		603380.0	1	1001080	4014486498240
25		609762.0	1	1001713	4014486486919
26		506671.0	1	1000506	4014486467840
26		506671.1	1	1000506	4014486467840
26		506671.2	1	1000506	4014486467840
27		623427.0	1	1000410	4014486466737
29	COUNTERSHAFT DRIVE	060306.0	1	1000723	4014486471151
32	TO NR. 09400750	603341.0	1	1003328	4014486463217
32	FROM NR. 09400751	783430.0	1	1000238	4014486463422
32	FROM NR. 09400751	783430.1	1	1000238	4014486463422
33	FOR 6.0 M - 9.0 M	670224.1	1	1001158	4014486497380
34	FOR 6.0 M - 9.0 M	670224.0	1	1001158	4014486497380
36	CHOPPER DRIVE (MAIZE)	061214.0	1	1000868	4014486473070
36	CHOPPER DRIVE (GRAIN) (FROM NR. 09403058)	061353.0	1	1000870	4014486473094
36	CHOPPER DRIVE (GRAIN) (FROM NR. 09403058)	061353.1	1	1000870	4014486473094
36	CHOPPER DRIVE (GRAIN) (TO NR. 09403057)	061360.0	1	1000870	4014486473094
36	CHOPPER DRIVE (GRAIN) (TO NR. 09403057)	061360.1	1	1000870	4014486473094
37		628630.0	1	1001208	4014486497670
40		695610.0	1	No AP	
41		680334.0	1	1001819	4014486488364
41		680334.1	1	1001819	4014486488364
		603380.1	1	1001080	4014486498240
		623427.1	1	1000409	4014486466720
	MAIN/DRUM	629000.1	1	1003661	4014486490657
	ELEVATOR DRIVE UNIT	629732.1	1	1000416	4014486466799
	SHAFT BASE 1177 MM	629836.1	2	1003819	4014486518870
		640653.1	1	1000350	4014486466065
	FOR TWO-STAGE DRIVE	661220.1	1	1003340	4014486488807
	TABLE CLUTCH	673638.1	1	1001099	4014486496819



# CLAAS

## DOMINATOR 128 VX

0	TO NO. 09408296	060306.2	1	1000723	4014486471151
0	TO NO. 09408296	060306.4	1	1000723	4014486471151
0	N = 519 MIN-1	066034.0	1	1000302	4014486465037
0		506671.0	1	1000506	4014486467840
0		506671.1	1	1000506	4014486467840
0		755070.0	2	1002795	4014486463279
0		755070.2	2	1002795	4014486463279
1		544049.1	2	1001561	4014486484618
2	MERCEDES OM 906 LA	656028.0	1	1003335	4014486462869
2	MERCEDES OM 366 LA	767057.1	1	1003333	4014486462609
3	MERCEDES OM 906 LA	621903.0	1	1002041	4014486475166
3	MERCEDES OM 906 LA	621903.1	1	1002041	4014486475166
3	MERCEDES OM 366 LA	629908.0	1	1002332	4014486478631
3	MERCEDES OM 366 LA	629908.1	1	1002332	4014486478631
4		660409.0	1	1001575	4014486484809
5	MERCEDES OM 906 LA	544083.0	1	1001968	4014486490794
5	MERCEDES OM 366 LA	644404.0	1	1003354	4014486490763
5	MERCEDES OM 366 LA	644404.1	1	1003354	4014486490763
6		603337.0	1	1000662	4014486470260
7		644141.1	1	1000476	4014486467475
8		644447.0	1	1000420	4014486466836
9		623427.1	1	1000409	4014486466720
10		755070.1	2	1002795	4014486463279
11	N = 660 MIN-1	785341.0	1	1000295	4014486464870
12		661337.0	2	1000845	4014486472745
12		661337.1	2	1000845	4014486472745
13	FOR CORN	061214.0	1	1000868	4014486473070
13	TO NO. 09408296	061353.0	1	1000870	4014486473094
13	TO NO. 09408296	061353.1	1	1000870	4014486473094
13	FROM NO. 09408297	644539.0	1	1000871	4014486473100
14		603380.1	1	1001080	4014486498240
15		609762.0	1	1001713	4014486486919
17	TO NO. 09408296	060306.3	1	No AP	
17	FROM NO. 09408297	644538.0	1	1001655	4014486486094
19		506671.2	1	1000506	4014486467840
20	MERCEDES OM 906 LA	545689.0	1	1003332	4014486461886
20	MERCEDES OM 366 LA	661345.0	1	1000160	4014486461824
21	MERCEDES OM 366 LA	661244.0	1	1000125	4014486461374
22	TO NO. 09408296	644448.0	1	1000139	4014486461565
22	FROM NO. 09408297	644537.0	1	1000140	4014486461572
23	TWO STAGE DRIVE	609823.0	1	1001225	4014486497809
24	DRUM VARIABLE SPEED DRIVE N = 650 - 1500	661220.0	1	1003340	4014486488807
24	DRUM VARIABLE SPEED DRIVE N = 650 - 1500	661220.1	1	1003340	4014486488807
24	DRUM VARIABLE SPEED DRIVE N = 250 - 1250	661298.0	1	1001630	4014486485738

## DOMINATOR 130

1	THRESHING MECHANISM DRIVE	628888.0	1	1001684	4014486486551
2	SIEVE PAN DRIVE	724141.0	1	1000709	4014486470970
3	DISCHARGE DRIVE GRAIN TANK	672351.0	1	1001570	4014486484731
5	AIR CONDITIONING COMPRESSOR DRIVE	349065.0	1	1002050	4014486475265
6	INTENSIVE SEPARATION SYSTEM DRIVE	802931.0	1	1003456	4014486465945
7	CUTTERBAR DRIVE	603290.0		1000764	4014486471670
8	CHOPPER DRIVE	061902.0	1	1000851	4014486472813



## CLAAS

9	CUTTERBAR DRIVE	673638.1	1	1001099	4014486496819
10	FAN DRIVE VARIABLE SPEED	603380.1	1	1001080	4014486498240
11	SIEVE PAN DRIVE	724247.0	1	1000849	4014486472783
11	SIEVE PAN DRIVE	724247.1	1	1000849	4014486472783
12	CHOPPER DRIVE	061872.0	2	1002867	4014486471939
14	STRAW WALKER DRIVE	785176.0	1	1000389	4014486466522
16	DRUM DRIVE VARIABLE SPEED (N=500-1400 RPM)	661430.0	1	1001229	4014486497830
16	DRUM DRIVE VARIABLE SPEED (N=650-1500 RPM)	661430.0	1	1001229	4014486497830

### DOMINATOR 140

1	THRESHING MECHANISM DRIVE	628888.0	1	1001684	4014486486551
2	SIEVE PAN DRIVE	724141.0	1	1000709	4014486470970
3	DISCHARGE DRIVE GRAIN TANK	672351.0	1	1001570	4014486484731
5	AIR CONDITIONING COMPRESSOR DRIVE	349065.0	1	1002050	4014486475265
6	INTENSIVE SEPARATION SYSTEM DRIVE	802931.0	1	1003456	4014486465945
7	CUTTERBAR DRIVE	603290.0	1	1000764	4014486471670
8	CHOPPER DRIVE	061902.0	1	1000851	4014486472813
9	CUTTERBAR DRIVE	673638.1	1	1001099	4014486496819
10	FAN DRIVE VARIABLE SPEED	603380.1	1	1001080	4014486498240
11	SIEVE PAN DRIVE	724247.0	1	1000849	4014486472783
11	SIEVE PAN DRIVE	724247.1	1	1000849	4014486472783
12	CHOPPER DRIVE	061872.0	2	1002867	4014486471939
14	STRAW WALKER DRIVE	785176.0	1	1000389	4014486466522
16	DRUM DRIVE VARIABLE SPEED (N=500-1400 RPM)	661430.0	1	1001229	4014486497830
16	DRUM DRIVE VARIABLE SPEED (N=650-1500 RPM)	661430.0	1	1001229	4014486497830

### DOMINATOR 150

1	THRESHING MECHANISM DRIVE	628888.0	1	1001684	4014486486551
2	SIEVE PAN DRIVE	724141.0	1	1000709	4014486470970
3	DISCHARGE DRIVE GRAIN TANK	672351.0	1	1001570	4014486484731
5	AIR CONDITIONING COMPRESSOR DRIVE	349065.0	1	1002050	4014486475265
6	INTENSIVE SEPARATION SYSTEM DRIVE	802931.0	1	1003456	4014486465945
7	CUTTERBAR DRIVE	603290.0	1	1000764	4014486471670
8	CHOPPER DRIVE	061902.0	1	1000851	4014486472813
9	CUTTERBAR DRIVE	673638.1	1	1001099	4014486496819
10	FAN DRIVE VARIABLE SPEED	603380.1	1	1001080	4014486498240
11	SIEVE PAN DRIVE	724247.0	1	1000849	4014486472783
11	SIEVE PAN DRIVE	724247.1	1	1000849	4014486472783
12	CHOPPER DRIVE	061872.0	2	1002867	4014486471939
14	STRAW WALKER DRIVE	785176.0	1	1000389	4014486466522
16	DRUM DRIVE VARIABLE SPEED (N=500-1400 RPM)	661430.0	1	1001229	4014486497830
16	DRUM DRIVE VARIABLE SPEED (N=650-1500 RPM)	661430.0	1	1001229	4014486497830

### DOMINATOR 202 II MEGA

0	STRAW CHOPPER	060306.2	1	1000723	4014486471151
0	STRAW CHOPPER	060306.4	1	1000723	4014486471151
0	STRAW WALKER	506671.0	1	1000506	4014486467840
0	STRAW WALKER	506671.1	1	1000506	4014486467840
0	SIEVE PAN / AUGER	603017.0	2	1000833	4014486472592
0	FEEDER HOUSING CUTTERBAR	644369.1	2	1002873	4014486472851
0	PRE - ACCELERATOR	661031.3	1	1001564	4014486484663
0	AT 2 STAGE DRIVE	661220.0	1	1003340	4014486488807
1	GROUND DRIVE	644465.0	1	1001818	4014486488340
2	HYDRAULIC PUMP	767057.1	1	1003333	4014486462609
3	AIR CONDITIONER	629908.0	1	1002332	4014486478631



## CLAAS

3	AIR CONDITIONER	629908.1	1	1002332	4014486478631
4	GRAIN TANK	629769.0	1	1002699	4014486484922
4	GRAIN TANK	629769.1	1	1002699	4014486484922
5	THRESHING MECHANISM	661458.0	1	1001957	4014486490640
6	INTERMEDIATE DRIVE 1	603337.0	1	1000662	4014486470260
7	INTERMEDIATE DRIVE 2	603336.0	1	1000478	4014486467499
7	INTERMEDIATE DRIVE 2	603336.1	1	1000478	4014486467499
8	FEED RAKE DRIVE	644447.0	1	1000420	4014486466836
11	AT 3.6M - 5.1M	670224.1	1	1001158	4014486497380
13	FOR CORN PICKER	692149.0	1	1001852	4014486488869
13	FOR CORN PICKER	692150.0	1	1001857	4014486488920
16	AT 6.0M - 6.6M	671013.1	1	1000676	4014486470482
18	AT 3.6M - 5.1M	713506.0	1	1000315	4014486465310
18	AT 3.6M - 5.1M	713506.1	1	1000315	4014486465310
18	AT 3.6M - 5.1M	713506.2	1	1000315	4014486465310
20	FEEDER HOUSING CUTTERBAR	644369.0	2	1002873	4014486472851
21	PRE - ACCELERATOR	661031.1	1	1001564	4014486484663
22	FAN	671209.0	1	1001039	4014486496383
23	SIEVE PAN / AUGER	603017.3	2	1000833	4014486472592
24	STRAW WALKER	506671.2	1	1000506	4014486467840
25	STRAW SPREADER	635494.0	2	1000382	4014486466454
25	STRAW SPREADER	635494.1	2	1000382	4014486466454
27	STRAW CHOPPER	060306.3	1	No AP	
29	RADIATOR SCREEN	661345.0	1	1000160	4014486461824
30	GEAR	657793.0	1	1000107	4014486461114
32	FOR CORN - CHOPPER	061213.0	1	1000860	4014486472943
32	FOR GRAIN - CHOPPER	061361.0	1	1000861	4014486472967
33	AT 2 STAGE DRIVE	609823.0	1	1001225	4014486497809
35	AT 6.0M - 6.6M	670224.1	1	1001158	4014486497380
37	SUCTION FAN	644448.0	1	1000139	4014486461565
40	FOR HPH-G CHOPPER	695610.0	1	No AP	
41	FOR HPH-G CHOPPER	680334.0	1	1001819	4014486488364
41	FOR HPH-G CHOPPER	680334.1	1	1001819	4014486488364
42	N = 650 - 1500 MIN-1	644418.0	1	1001212	4014486497717
43	AT MERCEDES OM 366A	133630.1	2	1002961	4014486495058
43	AT PERKINS 1006.6 T	147233.1	2	1002945	4014486495492
	SIEVE PAN / AUGER	603017.2	2	1000833	4014486472592
	N = 650 - 1500 MIN-1	644418.1	1	1001212	4014486497717
	PRE - ACCELERATOR	661031.2	1	1001564	4014486484663
	AT 2 STAGE DRIVE	661220.1	1	1003340	4014486488807
	THRESHING MECHANISM	661458.1	1	1001957	4014486490640

### DOMINATOR 202 MEGA

0	STRAW CHOPPER	060306.3	1	No AP	
0	STRAW CHOPPER	060306.4	1	1000723	4014486471151
0	STRAW WALKER	506671.0	1	1000506	4014486467840
0	STRAW WALKER	506671.1	1	1000506	4014486467840
0		603017.0	2	1000833	4014486472592
0	PRE - ACCELERATOR	661031.2	1	1001564	4014486484663
0	AT 2 STAGE DRIVE	661220.0	1	1003340	4014486488807
0	SHAFTS DISTANCE 1463MM	661378.0	2	1000852	4014486472820
1	GROUND DRIVE	644465.0	1	1001818	4014486488340
2	HYDRAULIC PUMP	767057.1	1	1003333	4014486462609
3	AIR CONDITIONER	629908.0	1	1002332	4014486478631
3	AIR CONDITIONER	629908.1	1	1002332	4014486478631

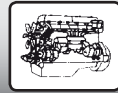

## CLAAS

4	GRAIN TANK	629769.0	1	1002699	4014486484922
4	GRAIN TANK	629769.1	1	1002699	4014486484922
5	THRESHING MECHANISM	661458.0	1	1001957	4014486490640
6	GEAR	603337.0	1	1000662	4014486470260
7		603336.0	1	1000478	4014486467499
7		603336.1	1	1000478	4014486467499
8	FEED RAKE DRIVE	644447.0	1	1000420	4014486466836
11	AT 3.6M - 5.1M	670224.1	1	1001158	4014486497380
13	FOR CORN PICKER	692149.0	1	1001852	4014486488869
13	FOR CORN PICKER	692150.0	1	1001857	4014486488920
16	AT 6.0M - 6.6M	671013.1	1	1000676	4014486470482
18	AT 3.6M - 5.1M	713506.0	1	1000315	4014486465310
18	AT 3.6M - 5.1M	713506.1	1	1000315	4014486465310
18	AT 3.6M - 5.1M	713506.2	1	1000315	4014486465310
20	SHAFTS DISTANCE 1306MM	661337.0	2	1000845	4014486472745
20	SHAFTS DISTANCE 1306MM	661337.1	2	1000845	4014486472745
20	SHAFTS DISTANCE 1463MM	661378.1	2	1000852	4014486472820
21	PRE - ACCELERATOR	661031.0	1	1001564	4014486484663
22	FAN	671209.0	1	1001039	4014486496383
23		603017.3	2	1000833	4014486472592
24	STRAW WALKER	506671.2	1	1000506	4014486467840
25	STRAW SPREADER	635494.0	2	1000382	4014486466454
25	STRAW SPREADER	635494.1	2	1000382	4014486466454
27	STRAW CHOPPER	060306.2	1	1000723	4014486471151
29	RADIATOR SCREEN	661345.0	1	1000160	4014486461824
30	GEAR	657793.0	1	1000107	4014486461114
32	FOR CORN CHOPPER	061213.0	1	1000860	4014486472943
32	FOR GRAIN CHOPPER	061361.0	1	1000861	4014486472967
33	AT 2 STAGE DRIVE	609823.0	1	1001225	4014486497809
35	AT 6.0M - 6.6M	670224.1	1	1001158	4014486497380
37	SUCTION FAN	644448.0	1	1000139	4014486461565
40	FOR HPH-G CHOPPER	695610.0	1	No AP	
41	FOR HPH-G CHOPPER	680334.0	1	1001819	4014486488364
41	FOR HPH-G CHOPPER	680334.1	1	1001819	4014486488364
42	N = 650 - 1500 MIN-1	644418.0	1	1001212	4014486497717
43	AT MERCEDES OM 366 A	133630.1	2	1002961	4014486495058
43	AT PERKINS 1006.6 T	147233.1	2	1002945	4014486495492
		603017.2	2	1000833	4014486472592
	N = 650 - 1500 MIN-1	644418.1	1	1001212	4014486497717
	PRE - ACCELERATOR	661031.1	1	1001564	4014486484663
	AT 2 STAGE DRIVE	661220.1	1	1003340	4014486488807
	SHAFTS DISTANCE 1463MM	661378.2	2	1000852	4014486472820
	THRESHING MECHANISM	661458.1	1	1001957	4014486490640

### DOMINATOR 203 II MEGA

0	STRAW CHOPPER	060306.2	1	1000723	4014486471151
0	TO NO. 93500772	060306.2	1	1000723	4014486471151
0	STRAW CHOPPER	060306.4	1	1000723	4014486471151
0	TO NO. 93500772	060306.4	1	1000723	4014486471151
0	STRAW WALKER	506671.0	1	1000506	4014486467840
0	STRAW WALKER	506671.1	1	1000506	4014486467840
0	RADIATOR SCREEN WITH MERCEDES OM 906 LA	545668.2	1	1004356	4014486714005
0	SIEVE PAN	603017.0	2	1000833	4014486472592
0	FEEDER CHANNEL	644369.1	2	1002873	4014486472851
0	PRE - ACCELERATOR	661031.3	1	1001564	4014486484663

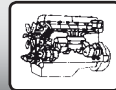

## CLAAS

0	FOR MULTIMASTER	661362.0	1	1001951	4014486490565
0	GROUND DRIVE	661362.0	1	1001951	4014486490565
1	WITH MERCEDES OM 906 LA	644016.1	1	1001800	4014486488104
1	GROUND DRIVE	661362.1	1	1001951	4014486490565
1	AT MERCEDES OM 366 LA WITH 163 KW	661451.0	1	1001958	4014486490664
2	HYDRAULIC PUMP WITH MERCEDES OM 906 LA	656028.0	1	1003335	4014486462869
2	HYDRAULIC PUMP	767057.1	1	1003333	4014486462609
3	AIR CONDITIONING WITH MERCEDES OM 906 LA	621903.0	1	1002041	4014486475166
3	AIR CONDITIONING WITH MERCEDES OM 906 LA	621903.1	1	1002041	4014486475166
3	AIR CONDITIONER	629908.0	1	1002332	4014486478631
3	AIR CONDITIONER	629908.1	1	1002332	4014486478631
4	WITH MERD	544166.0	1	1003360	4014486484830
4	GRAIN TANK	629769.0	1	1002699	4014486484922
4	GRAIN TANK	629769.1	1	1002699	4014486484922
4	AT MERCEDES OM 366 LA WITH 163 KW	660409.0	1	1001575	4014486484809
5	WITH MERCEDES OM 906 LA	544164.0	1	1001969	4014486490800
5	AT MERCEDES OM 366 LA WITH 163 KW	644404.0	1	1003354	4014486490763
5	AT MERCEDES OM 366 LA WITH 163 KW	644404.1	1	1003354	4014486490763
5	THRESHING MECHANISM	661458.0	1	1001957	4014486490640
6	GEAR	603337.0	1	1000662	4014486470260
7		603336.0	1	1000478	4014486467499
7		603336.1	1	1000478	4014486467499
8	FEED RAKE DRIVE	644447.0	1	1000420	4014486466836
11	AT 3.9M - 5.1M	670224.1	1	1001158	4014486497380
13	FOR MULTIMASTER	661362.1	1	1001951	4014486490565
13	FOR CORN PICKER	692149.0	1	1001852	4014486488869
13	FOR CORN PICKER	692150.0	1	1001857	4014486488920
16	AT 6.0M - 7.5M	671013.1	1	1000676	4014486470482
18	AT 3.9M - 5.1M	713506.0	1	1000315	4014486465310
18	AT 3.9M - 5.1M	713506.1	1	1000315	4014486465310
18	AT 3.9M - 5.1M	713506.2	1	1000315	4014486465310
20	FEEDER CHANNEL	644369.0	2	1002873	4014486472851
21	PRE - ACCELERATOR	661031.1	1	1001564	4014486484663
22	BLOWER - 203 MEGA	671209.0	1	1001039	4014486496383
23	SIEVE PAN	603017.3	2	1000833	4014486472592
24	STRAW WALKER	506671.2	1	1000506	4014486467840
25	STRAW SPREADER	623427.1	1	1000409	4014486466720
27	STRAW CHOPPER	060306.3	1	No AP	
27	TO NO. 93500772	060306.3	1	No AP	
29	RADIATOR SCREEN WITH MERCEDES OM 906 LA	545668.1	1	1000119	4014486461305
29	RADIATOR SCREEN	661345.0	1	1000160	4014486461824
30	WITH MERCEDES OM 906 LA	545689.0	1	1003332	4014486461886
30	MERCEDES OM 366 LA	657793.0	1	1000107	4014486461114
30	PERKINS 1006.6 T	657793.0	1	1000107	4014486461114
30	MERCEDES OM 366 LA 163 KW	661244.0	1	1000125	4014486461374
32	FOR CORN - CHOPPER	061214.0	1	1000868	4014486473070
32	GRAIN	061353.0	1	1000870	4014486473094
32	GRAIN	061353.1	1	1000870	4014486473094
33	AT 2 STAGE DRIVE	609823.0	1	1001225	4014486497809
33	AT DOMINATOR 204 MEGA WITH N = 650 - 1500 MIN-1	609823.0	1	1001225	4014486497809
34	AT 2 STAGE DRIVE	661220.0	1	1003340	4014486488807
34	AT DOMINATOR 204 MEGA WITH N = 650 - 1500 MIN-1	661220.0	1	1003340	4014486488807
34	AT 2 STAGE DRIVE	661220.1	1	1003340	4014486488807
34	AT DOMINATOR 204 MEGA WITH N = 650 - 1500 MIN-1	661220.1	1	1003340	4014486488807
35	AT 6.0M - 7.5M	670224.1	1	1001158	4014486497380

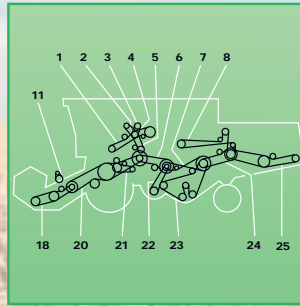
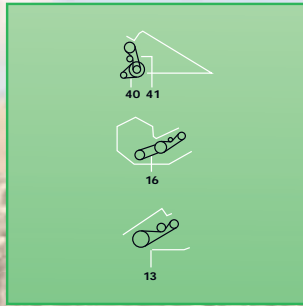
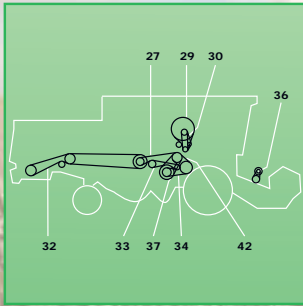

## CLAAS

37	SUCTION FAN	644448.0	1	1000139	4014486461565
40	FOR HPH - G CHOPPER	695610.0	1	No AP	
41	FOR HPH - G CHOPPER	680334.0	1	1001819	4014486488364
41	FOR HPH - G CHOPPER	680334.1	1	1001819	4014486488364
42	AT DOMINATOR 203 MEGA WITH N = 650 - 1500 MIN-1	644418.0	1	1001212	4014486497717
43	MERCEDES 366 LA (147 KW)	133635.1	2	1002958	4014486495782
43	MERCEDES 366 LA (163 KW)	133642.0	2	1003772	4014486495737
43	AT PERKINS 1006.6 T	147233.1	2	1002945	4014486495492
	SIEVE PAN	603017.2	2	1000833	4014486472592
	AT DOMINATOR 203 MEGA WITH N = 650 - 1500 MIN-1	644418.1	1	1001212	4014486497717
	PRE - ACCELERATOR	661031.2	1	1001564	4014486484663
	FOR MULTIMASTER	661362.2	1	No AP	
	GROUND DRIVE	661362.2	1	No AP	
	THRESHING MECHANISM	661458.1	1	1001957	4014486490640

### DOMINATOR 203 MEGA

0	STRAW CHOPPER	060306.3	1	No AP	
0	STRAW CHOPPER DRIVE	060306.3	1	No AP	
0	STRAW CHOPPER	060306.4	1	1000723	4014486471151
0	STRAW CHOPPER DRIVE	060306.4	1	1000723	4014486471151
0	STRAW WALKER	506671.0	1	1000506	4014486467840
0	STRAW WALKER DRIVE	506671.0	1	1000506	4014486467840
0	STRAW WALKER	506671.1	1	1000506	4014486467840
0	STRAW WALKER DRIVE	506671.1	1	1000506	4014486467840
0	SHAKER SHOE - 203 MEGA	603017.0	2	1000833	4014486472592
0	SIEVE PAN	603017.0	2	1000833	4014486472592
0	FOR TWO-STAGE DRIVE	609823.0	1	1001225	4014486497809
0	ACCELERATOR	661031.2	1	1001564	4014486484663
0	PRE - ACCELERATOR	661031.2	1	1001564	4014486484663
0	AT 2 STAGE DRIVE	661220.0	1	1003340	4014486488807
0	FOR TWO-STAGE DRIVE	661220.0	1	1003340	4014486488807
0	GROUND DRIVE	661362.0	1	1001951	4014486490565
0	SHAFT BASE 1463 MM	661378.0	2	1000852	4014486472820
0	SHAFTS DISTANCE 1463 MM	661378.0	2	1000852	4014486472820
1	TRAVEL DRIVE	661362.0	1	1001951	4014486490565
1	GROUND DRIVE	661362.1	1	1001951	4014486490565
1	TRAVEL DRIVE	661362.1	1	1001951	4014486490565
1	TRAVEL DRIVE	661362.2	1	No AP	
1	AT MERCEDES OM 366 LA WITH 163 KW	661451.0	1	1001958	4014486490664
2	HYDRAULIC PUMP	767057.1	1	1003333	4014486462609
2	HYDRAULIC PUMP DRIVE	767057.1	1	1003333	4014486462609
3	AIR CONDITIONER	629908.0	1	1002332	4014486478631
3	AIR CONDITIONING COMPRESSOR DRIVE	629908.0	1	1002332	4014486478631
3	AIR CONDITIONER	629908.1	1	1002332	4014486478631
3	AIR CONDITIONING COMPRESSOR DRIVE	629908.1	1	1002332	4014486478631
4	GRAIN TANK	629769.0	1	1002699	4014486484922
4	TANK UNLOADER DRIVE	629769.0	1	1002699	4014486484922
4	GRAIN TANK	629769.1	1	1002699	4014486484922
4	TANK UNLOADER DRIVE	629769.1	1	1002699	4014486484922
4	AT MERCEDES OM 366 LA WITH 163 KW	660409.0	1	1001575	4014486484809
5	AT MERCEDES OM 366 LA WITH 163 KW	644404.0	1	1003354	4014486490763
5	AT MERCEDES OM 366 LA WITH 163 KW	644404.1	1	1003354	4014486490763
5	THRESHING MACHINE	661458.0	1	1001957	4014486490640
5	THRESHING MECHANISM	661458.0	1	1001957	4014486490640
6	COUNTERSHAFT DRIVE	603337.0	1	1000662	4014486470260



## CLAAS

6	GEAR	603337.0	1	1000662	4014486470260
7		603336.0	1	1000478	4014486467499
7	FOR DOMINATOR 203 MEGA	603336.0	1	1000478	4014486467499
7		603336.1	1	1000478	4014486467499
7	FOR DOMINATOR 203 MEGA	603336.1	1	1000478	4014486467499
7		644141.1	1	1000476	4014486467475
8	FEED RAKE DRIVE	644447.0	1	1000420	4014486466836
11	AT 3.9M - 5.1M	670224.1	1	1001158	4014486497380
11	REEL DRIVE BY 3.9 M - 5.1 M CUTTING TABLE	670224.1	1	1001158	4014486497380
13	FOR MULTIMASTER	629142.0	1	1001954	4014486490596
13	FOR CORN PICKER	692149.0	1	1001852	4014486488869
13	FOR MAIZE PICKER	692149.0	1	1001852	4014486488869
13	FOR CORN PICKER	692150.0	1	1001857	4014486488920
13	FOR MAIZE PICKER	692150.0	1	1001857	4014486488920
16	AT 6.0M - 7.5M	671013.1	1	1000676	4014486470482
16	FOR 6.0 - 7.5 M CUTTING TABLE	671013.1	1	1000676	4014486470482
18	AT 3.9M - 5.1M	713506.0	1	1000315	4014486465310
18	KNIFE DRIVE 3.9 - 5.1 M CUTTING TABLE	713506.0	1	1000315	4014486465310
18	AT 3.9M - 5.1M	713506.1	1	1000315	4014486465310
18	KNIFE DRIVE 3.9 - 5.1 M CUTTING TABLE	713506.1	1	1000315	4014486465310
18	AT 3.9M - 5.1M	713506.2	1	1000315	4014486465310
18	KNIFE DRIVE 3.9 - 5.1 M CUTTING TABLE	713506.2	1	1000315	4014486465310
20	SHAFT 1306 MM	661337.0	2	1000845	4014486472745
20	SHAFTS DISTANCE 1306 MM	661337.0	2	1000845	4014486472745
20	SHAFT 1306 MM	661337.1	2	1000845	4014486472745
20	SHAFTS DISTANCE 1306 MM	661337.1	2	1000845	4014486472745
20	SHAFT BASE 1463 MM	661378.1	2	1000852	4014486472820
20	SHAFTS DISTANCE 1463 MM	661378.1	2	1000852	4014486472820
21	ACCELERATOR	661031.0	1	1001564	4014486484663
21	PRE - ACCELERATOR	661031.0	1	1001564	4014486484663
22	BLOWER - 204 MEGA	603380.1	1	1001080	4014486498240
22	BLOWER - 203 MEGA	671209.0	1	1001039	4014486496383
22	BLOWER - DOMINATOR 203 MEGA	671209.0	1	1001039	4014486496383
23	SHAKER SHOE - 203 MEGA	603017.3	2	1000833	4014486472592
23	SIEVE PAN	603017.3	2	1000833	4014486472592
23	SIEVE PAN	609762.0	1	1001713	4014486486919
24	STRAW WALKER	506671.2	1	1000506	4014486467840
24	STRAW WALKER DRIVE	506671.2	1	1000506	4014486467840
25	STRAW DISTRIBUTOR	623427.1	1	1000409	4014486466720
25	STRAW SPREADER	623427.1	1	1000409	4014486466720
27	STRAW CHOPPER	060306.2	1	1000723	4014486471151
27	STRAW CHOPPER DRIVE	060306.2	1	1000723	4014486471151
29	COOLER	661345.0	1	1000160	4014486461824
29	RADIATOR SCREEN	661345.0	1	1000160	4014486461824
30	COUNTERSHAFT DRIVE	657793.0	1	1000107	4014486461114
30	GEAR	657793.0	1	1000107	4014486461114
32	FOR CORN CHOPPER	061214.0	1	1000868	4014486473070
32	STRAW CHOPPER (MAIZE)	061214.0	1	1000868	4014486473070
32	FOR GRAIN CHOPPER FROM NO. 09350552	061353.0	1	1000870	4014486473094
32	FOR GRAIN CHOPPER FROM NO. 09350552	061353.1	1	1000870	4014486473094
32	STRAW CHOPPER (GRAIN)	061360.0	1	1000870	4014486473094
32	TO NO. 09350551	061360.0	1	1000870	4014486473094
32	STRAW CHOPPER (GRAIN)	061360.1	1	1000870	4014486473094
32	TO NO. 09350551	061360.1	1	1000870	4014486473094
33	AT 2 STAGE DRIVE	609823.0	1	1001225	4014486497809





## CLAAS

35	AT 6.0M - 7.5M	670224.1	1	1001158	4014486497380
35	REEL DRIVE BY 6.0 M - 7.5 M CUTTING TABLE	670224.1	1	1001158	4014486497380
37	AIR EXHAUST	644448.0	1	1000139	4014486461565
37	SUCTION FAN	644448.0	1	1000139	4014486461565
40	CHOPPER DRIVE	695610.0	1	No AP	
40	FOR HPH - G CHOPPER	695610.0	1	No AP	
41	CHOPPER DRIVE	680334.0	1	1001819	4014486488364
41	FOR HPH - G CHOPPER	680334.0	1	1001819	4014486488364
41	CHOPPER DRIVE	680334.1	1	1001819	4014486488364
41	FOR HPH - G CHOPPER	680334.1	1	1001819	4014486488364
42	AT DOMINATOR 203 MEGA WITH N = 650 - 1500 MIN-1	644418.0	1	1001212	4014486497717
43	AT MERCEDES OM 366 A	133630.1	2	1002961	4014486495058
43	FOR MERCEDES ENGINE OM 366 LA	133635.0	2	1002958	4014486495782
43	AT MERCEDES OM 366 LA	133635.1	2	1002958	4014486495782
43	AT PERKINS 1006.6 T	147233.1	2	1002945	4014486495492
	SHAKER SHOE - 203 MEGA	603017.2	2	1000833	4014486472592
	SIEVE PAN	603017.2	2	1000833	4014486472592
	AT DOMINATOR 203 MEGA WITH N = 650 - 1500 MIN-1	644418.1	1	1001212	4014486497717
	ACCELERATOR	661031.1	1	1001564	4014486484663
	PRE - ACCELERATOR	661031.1	1	1001564	4014486484663
	AT 2 STAGE DRIVE	661220.1	1	1003340	4014486488807
	FOR TWO-STAGE DRIVE	661220.1	1	1003340	4014486488807
	GROUND DRIVE	661362.2	1	No AP	
	SHAFT BASE 1463 MM	661378.2	2	1000852	4014486472820
	SHAFTS DISTANCE 1463 MM	661378.2	2	1000852	4014486472820
	THRESHING MACHINE	661458.1	1	1001957	4014486490640
	THRESHING MECHANISM	661458.1	1	1001957	4014486490640
<b>DOMINATOR 204 II MEGA</b>					
0	TO NO. 93500772	060306.2	1	1000723	4014486471151
0	TO NO. 93500772	060306.4	1	1000723	4014486471151
0	STRAW WALKER	506671.0	1	1000506	4014486467840
0	STRAW WALKER	506671.1	1	1000506	4014486467840
0	RADIATOR SCREEN WITH MERCEDES OM 906 LA	545668.2	1	1004356	4014486714005
0	FEEDER CHANNEL	644369.1	2	1002873	4014486472851
0	PRE - ACCELERATOR	661031.3	1	1001564	4014486484663
0	FOR MULTIMASTER	661362.0	1	1001951	4014486490565
0	GROUND DRIVE	661362.0	1	1001951	4014486490565
0	AT 3.9M - 5.1M	713506.0	1	1000315	4014486465310
0	AT 3.9M - 5.1M	713506.2	1	1000315	4014486465310
1	WITH MERCEDES OM 906 LA	644016.1	1	1001800	4014486488104
1	GROUND DRIVE	661362.1	1	1001951	4014486490565
1	AT MERCEDES OM 366 LA WITH 163 KW	661451.0	1	1001958	4014486490664
2	HYDRAULIC PUMP WITH MERCEDES OM 906 LA	656028.0	1	1003335	4014486462869
2	HYDRAULIC PUMP	767057.1	1	1003333	4014486462609
3	AIR CONDITIONING WITH MERCEDES OM 906 LA	621903.0	1	1002041	4014486475166
3	AIR CONDITIONING WITH MERCEDES OM 906 LA	621903.1	1	1002041	4014486475166
3	AIR CONDITIONER	629908.0	1	1002332	4014486478631
3	AIR CONDITIONER	629908.1	1	1002332	4014486478631
4	WITH MERD	544166.0	1	1003360	4014486484830
4	GRAIN TANK	629769.0	1	1002699	4014486484922
4	GRAIN TANK	629769.1	1	1002699	4014486484922
4	AT MERCEDES OM 366 LA WITH 163 KW	660409.0	1	1001575	4014486484809
5	WITH MERCEDES OM 906 LA	544164.0	1	1001969	4014486490800
5	AT MERCEDES OM 366 LA WITH 163 KW	644404.0	1	1003354	4014486490763

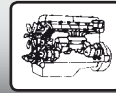
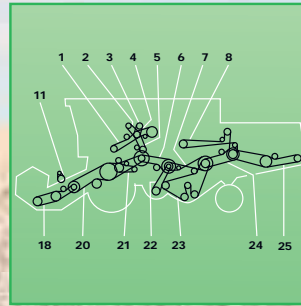
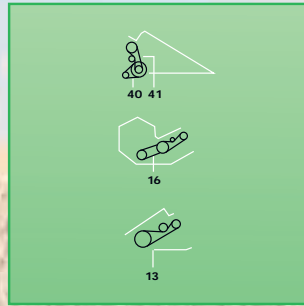
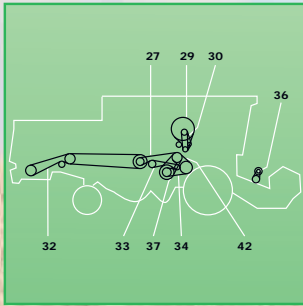

## CLAAS

5	AT MERCEDES OM 366 LA WITH 163 KW	644404.1	1	1003354	4014486490763
5	THRESHING MECHANISM	661458.0	1	1001957	4014486490640
6	GEAR	603337.0	1	1000662	4014486470260
7		644141.1	1	1000476	4014486467475
8	FEED RAKE DRIVE	644447.0	1	1000420	4014486466836
11	AT 3.9M - 5.1M	670224.1	1	1001158	4014486497380
13	FOR MULTIMASTER	661362.1	1	1001951	4014486490565
13	FOR CORN PICKER	692149.0	1	1001852	4014486488869
13	FOR CORN PICKER	692150.0	1	1001857	4014486488920
16	AT 6.0M - 7.5M	671013.1	1	1000676	4014486470482
20	FEEDER CHANNEL	644369.0	2	1002873	4014486472851
21	PRE - ACCELERATOR	661031.1	1	1001564	4014486484663
22	BLOWER - 204 MEGA	603380.1	1	1001080	4014486498240
23	SIEVE PAN	609762.0	1	1001713	4014486486919
24	STRAW WALKER	506671.2	1	1000506	4014486467840
25	STRAW SPREADER	623427.1	1	1000409	4014486466720
27	TO NO. 93500772	060306.3	1	No AP	
27	STRAW CHOPPER	644538.0	1	1001655	4014486486094
29	RADIATOR SCREEN WITH MERCEDES OM 906 LA	545668.1	1	1000119	4014486461305
29	RADIATOR SCREEN	661345.0	1	1000160	4014486461824
30	WITH MERCEDES OM 906 LA	545689.0	1	1003332	4014486461886
30	MERCEDES OM 366 LA	657793.0	1	1000107	4014486461114
30	PERKINS 1006.6 T	657793.0	1	1000107	4014486461114
30	MERCEDES OM 366 LA 163 KW	661244.0	1	1000125	4014486461374
32	FOR CORN - CHOPPER	061214.0	1	1000868	4014486473070
32	GRAIN	061353.0	1	1000870	4014486473094
32	GRAIN	061353.1	1	1000870	4014486473094
32	GRAIN	644539.0	1	1000871	4014486473100
33	AT 2 STAGE DRIVE	609823.0	1	1001225	4014486497809
33	AT DOMINATOR 204 MEGA WITH N = 650 - 1500 MIN-1	609823.0	1	1001225	4014486497809
34	AT 2 STAGE DRIVE	661220.0	1	1003340	4014486488807
34	AT DOMINATOR 204 MEGA WITH N = 650 - 1500 MIN-1	661220.0	1	1003340	4014486488807
34	AT 2 STAGE DRIVE	661220.1	1	1003340	4014486488807
34	AT DOMINATOR 204 MEGA WITH N = 650 - 1500 MIN-1	661220.1	1	1003340	4014486488807
35	AT 6.0M - 7.5M	670224.1	1	1001158	4014486497380
37	SUCTION FAN	644448.0	1	1000139	4014486461565
40	FOR HPH - G CHOPPER	695610.0	1	No AP	
41	FOR HPH - G CHOPPER	680334.0	1	1001819	4014486488364
41	FOR HPH - G CHOPPER	680334.1	1	1001819	4014486488364
43	MERCEDES 366 LA (147 KW)	133635.1	2	1002958	4014486495782
43	MERCEDES 366 LA (163 KW)	133642.0	2	1003772	4014486495737
43	AT PERKINS 1006.6 T	147233.1	2	1002945	4014486495492
	PRE - ACCELERATOR	661031.2	1	1001564	4014486484663
	FOR MULTIMASTER	661362.2	1	No AP	
	GROUND DRIVE	661362.2	1	No AP	
	THRESHING MECHANISM	661458.1	1	1001957	4014486490640
	AT 3.9M - 5.1M	713506.1	1	1000315	4014486465310

### DOMINATOR 204 MEGA

0	STRAW CHOPPER	060306.3	1	No AP	
0	STRAW CHOPPER DRIVE	060306.3	1	No AP	
0	STRAW CHOPPER	060306.4	1	1000723	4014486471151
0	STRAW CHOPPER DRIVE	060306.4	1	1000723	4014486471151
0	STRAW WALKER	506671.0	1	1000506	4014486467840
0	STRAW WALKER DRIVE	506671.0	1	1000506	4014486467840



## CLAAS

0	STRAW WALKER	506671.1	1	1000506	4014486467840
0	STRAW WALKER DRIVE	506671.1	1	1000506	4014486467840
0	FOR TWO-STAGE DRIVE	609823.0	1	1001225	4014486497809
0	ACCELERATOR	661031.2	1	1001564	4014486484663
0	PRE - ACCELERATOR	661031.2	1	1001564	4014486484663
0	AT 2 STAGE DRIVE	661220.0	1	1003340	4014486488807
0	AT DOMINATOR 204 MEGA WITH N = 650 · 1500 MIN-1	661220.0	1	1003340	4014486488807
0	FOR TWO-STAGE DRIVE	661220.0	1	1003340	4014486488807
0	N=650-1500 RPM	661220.0	1	1003340	4014486488807
0	GROUND DRIVE	661362.0	1	1001951	4014486490565
0	TRAVEL DRIVE	661362.0	1	1001951	4014486490565
0	SHAFT BASE 1463 MM	661378.0	2	1000852	4014486472820
0	SHAFTS DISTANCE 1463 MM	661378.0	2	1000852	4014486472820
1	GROUND DRIVE	661362.1	1	1001951	4014486490565
1	TRAVEL DRIVE	661362.1	1	1001951	4014486490565
1	TRAVEL DRIVE	661362.2	1	No AP	
1	AT MERCEDES OM 366 LA WITH 163 KW	661451.0	1	1001958	4014486490664
2	HYDRAULIC PUMP	767057.1	1	1003333	4014486462609
2	HYDRAULIC PUMP DRIVE	767057.1	1	1003333	4014486462609
3	AIR CONDITIONER	629908.0	1	1002332	4014486478631
3	AIR CONDITIONING COMPRESSOR DRIVE	629908.0	1	1002332	4014486478631
3	AIR CONDITIONER	629908.1	1	1002332	4014486478631
3	AIR CONDITIONING COMPRESSOR DRIVE	629908.1	1	1002332	4014486478631
4	GRAIN TANK	629769.0	1	1002699	4014486484922
4	TANK UNLOADER DRIVE	629769.0	1	1002699	4014486484922
4	GRAIN TANK	629769.1	1	1002699	4014486484922
4	TANK UNLOADER DRIVE	629769.1	1	1002699	4014486484922
4	AT MERCEDES OM 366 LA WITH 163 KW	660409.0	1	1001575	4014486484809
5	AT MERCEDES OM 366 LA WITH 163 KW	644404.0	1	1003354	4014486490763
5	AT MERCEDES OM 366 LA WITH 163 KW	644404.1	1	1003354	4014486490763
5	THRESHING MACHINE	661458.0	1	1001957	4014486490640
5	THRESHING MECHANISM	661458.0	1	1001957	4014486490640
6	COUNTERSHAFT DRIVE	603337.0	1	1000662	4014486470260
6	GEAR	603337.0	1	1000662	4014486470260
7	FOR DOMINATOR 204 MEGA	644141.1	1	1000476	4014486467475
7	GRAIN ELEVATOR · 204 MEGA FROM NO. 09350930	644141.1	1	1000476	4014486467475
8	FEED RAKE DRIVE	644447.0	1	1000420	4014486466836
11	AT 3.9M · 5.1M	670224.1	1	1001158	4014486497380
11	REEL DRIVE BY 3.9 M · 5.1 M CUTTING TABLE	670224.1	1	1001158	4014486497380
13	FOR MULTIMASTER	629142.0	1	1001954	4014486490596
13	FOR CORN PICKER	692149.0	1	1001852	4014486488869
13	FOR MAIZE PICKER	692149.0	1	1001852	4014486488869
13	FOR CORN PICKER	692150.0	1	1001857	4014486488920
13	FOR MAIZE PICKER	692150.0	1	1001857	4014486488920
16	AT 6.0M · 7.5M	671013.1	1	1000676	4014486470482
16	FOR 6.0 · 7.5 M CUTTING TABLE	671013.1	1	1000676	4014486470482
18	AT 3.9M · 5.1M	713506.0	1	1000315	4014486465310
18	KNIFE DRIVE 3.9 · 5.1 M CUTTING TABLE	713506.0	1	1000315	4014486465310
18	AT 3.9M · 5.1M	713506.1	1	1000315	4014486465310
18	KNIFE DRIVE 3.9 · 5.1 M CUTTING TABLE	713506.1	1	1000315	4014486465310
18	AT 3.9M · 5.1M	713506.2	1	1000315	4014486465310
18	KNIFE DRIVE 3.9 · 5.1 M CUTTING TABLE	713506.2	1	1000315	4014486465310
20	SHAFT 1306 MM	661337.0	2	1000845	4014486472745
20	SHAFTS DISTANCE 1306 MM	661337.0	2	1000845	4014486472745
20	SHAFT 1306 MM	661337.1	2	1000845	4014486472745



## CLAAS

20	SHAFTS DISTANCE 1306 MM	661337.1	2	1000845	4014486472745
20	SHAFT BASE 1463 MM	661378.1	2	1000852	4014486472820
20	SHAFTS DISTANCE 1463 MM	661378.1	2	1000852	4014486472820
21	ACCELERATOR	661031.0	1	1001564	4014486484663
21	PRE - ACCELERATOR	661031.0	1	1001564	4014486484663
22	BLOWER - 204 MEGA	603380.1	1	1001080	4014486498240
22	BLOWER - DOMINATOR 204 MEGA	603380.1	1	1001080	4014486498240
23	SHAKER SHOE - DOMINATOR 204 MEGA	609762.0	1	1001713	4014486486919
23	SIEVE PAN	609762.0	1	1001713	4014486486919
24	STRAW WALKER	506671.2	1	1000506	4014486467840
24	STRAW WALKER DRIVE	506671.2	1	1000506	4014486467840
25	STRAW DISTRIBUTOR	623427.1	1	1000409	4014486466720
25	STRAW SPREADER	623427.1	1	1000409	4014486466720
27	STRAW CHOPPER	060306.2	1	1000723	4014486471151
27	STRAW CHOPPER DRIVE	060306.2	1	1000723	4014486471151
29	COOLER	661345.0	1	1000160	4014486461824
29	RADIATOR SCREEN	661345.0	1	1000160	4014486461824
30	COUNTERSHAFT DRIVE	657793.0	1	1000107	4014486461114
30	GEAR	657793.0	1	1000107	4014486461114
32	FOR CORN CHOPPER	061214.0	1	1000868	4014486473070
32	STRAW CHOPPER (MAIZE)	061214.0	1	1000868	4014486473070
32	FOR GRAIN CHOPPER FROM NO. 09350552	061353.0	1	1000870	4014486473094
32	FOR GRAIN CHOPPER FROM NO. 09350552	061353.1	1	1000870	4014486473094
32	STRAW CHOPPER (GRAIN)	061360.0	1	1000870	4014486473094
32	TO NO. 09350551	061360.0	1	1000870	4014486473094
32	STRAW CHOPPER (GRAIN)	061360.1	1	1000870	4014486473094
32	TO NO. 09350551	061360.1	1	1000870	4014486473094
33	AT 2 STAGE DRIVE	609823.0	1	1001225	4014486497809
33	AT DOMINATOR 204 MEGA WITH N = 650 - 1500 MIN-1	609823.0	1	1001225	4014486497809
33	DOMINATOR 204 MEGA N=650-1500 RPM	609823.0	1	1001225	4014486497809
35	AT 6.0M - 7.5M	670224.1	1	1001158	4014486497380
35	REEL DRIVE BY 6.0 M - 7.5 M CUTTING TABLE	670224.1	1	1001158	4014486497380
37	AIR EXHAUST	644448.0	1	1000139	4014486461565
37	SUCTION FAN	644448.0	1	1000139	4014486461565
40	CHOPPER DRIVE	695610.0	1	No AP	
40	FOR HPH - G CHOPPER	695610.0	1	No AP	
41	CHOPPER DRIVE	680334.0	1	1001819	4014486488364
41	FOR HPH - G CHOPPER	680334.0	1	1001819	4014486488364
41	CHOPPER DRIVE	680334.1	1	1001819	4014486488364
41	FOR HPH - G CHOPPER	680334.1	1	1001819	4014486488364
42	DOMINATOR 204 MEGA N=650-1500 RPM	644418.0	1	1001212	4014486497717
43	AT MERCEDES OM 366 A	133630.1	2	1002961	4014486495058
43	FOR MERCEDES ENGINE OM 366 LA	133635.0	2	1002958	4014486495782
43	AT MERCEDES OM 366 LA	133635.1	2	1002958	4014486495782
43	AT PERKINS 1006.6 T	147233.1	2	1002945	4014486495492
	DOMINATOR 204 MEGA N=650-1500 RPM	644418.1	1	1001212	4014486497717
	ACCELERATOR	661031.1	1	1001564	4014486484663
	PRE - ACCELERATOR	661031.1	1	1001564	4014486484663
	AT 2 STAGE DRIVE	661220.1	1	1003340	4014486488807
	AT DOMINATOR 204 MEGA WITH N = 650 - 1500 MIN-1	661220.1	1	1003340	4014486488807
	DOMINATOR 204 MEGA N=650-1500 RPM	661220.1	1	1003340	4014486488807
	FOR TWO-STAGE DRIVE	661220.1	1	1003340	4014486488807
	GROUND DRIVE	661362.2	1	No AP	
	SHAFT BASE 1463 MM	661378.2	2	1000852	4014486472820
	SHAFTS DISTANCE 1463 MM	661378.2	2	1000852	4014486472820

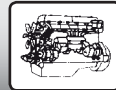

# CLAAS

	THRESHING MACHINE	661458.1	1	1001957	4014486490640
	THRESHING MECHANISM	661458.1	1	1001957	4014486490640
<b>DOMINATOR 208 II MEGA</b>					
0	TO NO. 94501058	060306.2	1	1000723	4014486471151
0	TO NO. 94501058	060306.4	1	1000723	4014486471151
0	STRAW WALKER	506671.0	1	1000506	4014486467840
0	STRAW WALKER	506671.1	1	1000506	4014486467840
0	OM 441 A HYDRAULIC PUMP	633030.0	1	1000220	4014486462838
0	FEEDER CHANNEL	644368.1	2	1000858	4014486472929
0	ACCELERATOR	661031.3	1	1001564	4014486484663
0	AT 4.5M - 5.1M	713506.0	1	1000315	4014486465310
0	AT 4.5M - 5.1M	713506.2	1	1000315	4014486465310
1	OM 441 A GROUND DRIVE	661239.1	1	1001244	4014486491999
1	OM 366 LA GROUND DRIVE	661451.0	1	1001958	4014486490664
2	OM 441 A HYDRAULIC PUMP	633030.2	1	1000220	4014486462838
2	OM 366 LA HYDRAULIC PUMP	767057.1	1	1003333	4014486462609
3	OM 366 LA AIR CONDITIONING	629908.0	1	1002332	4014486478631
3	OM 366 LA AIR CONDITIONING	629908.1	1	1002332	4014486478631
3	OM 441 A AIR CONDITIONING	661114.0	1	1002336	4014486478686
4	OM 366 LA GRAIN TANK	660409.0	1	1001575	4014486484809
4	OM 441 A GRAIN TANK	661093.0	1	1001581	4014486484885
5	OM 441 A THRESHING MECHANISM	644403.0	1	1001247	4014486492033
5	OM 366 LA THRESHING MECHANISM	644404.0	1	1003354	4014486490763
5	OM 366 LA THRESHING MECHANISM	644404.1	1	1003354	4014486490763
6	GEAR	603337.0	1	1000662	4014486470260
7		644141.1	1	1000476	4014486467475
8	FEED RAKE DRIVE	644447.0	1	1000420	4014486466836
11	AT 4.5M - 5.1M	670224.1	1	1001158	4014486497380
13	FOR MULTIMASTER	629142.0	1	1001954	4014486490596
13	FOR CORN PICKER	692149.0	1	1001852	4014486488869
13	FOR CORN PICKER	692150.0	1	1001857	4014486488920
16	AT 6.0M - 9M	671013.1	1	1000676	4014486470482
20	FEEDER CHANNEL	644368.0	2	1000858	4014486472929
21	ACCELERATOR	661031.1	1	1001564	4014486484663
22	FAN	603380.1	1	1001080	4014486498240
23	SIEVE BOX	609762.0	1	1001713	4014486486919
24	STRAW WALKER	506671.2	1	1000506	4014486467840
25	STRAW SPREADER	623427.1	1	1000409	4014486466720
27	TO NO. 94501058	060306.3	1	No AP	
27	STRAW CHOPPER FROM NO. 94501059	644538.0	1	1001655	4014486486094
30	RADIATOR SCREEN	661345.0	1	1000160	4014486461824
31	OM 366 LA INTERMEDIATE DRIVE	661244.0	1	1000125	4014486461374
31	OM 441 A INTERMEDIATE DRIVE	661245.0	1	1003377	4014486461435
33	FOR CORN CHOPPER	061214.0	1	1000868	4014486473070
33	FOR GRAIN CHOPPER TO NO. 94501058	061353.0	1	1000870	4014486473094
33	FOR GRAIN CHOPPER TO NO. 94501058	061353.1	1	1000870	4014486473094
33	FOR GRAIN CHOPPER FROM NO. 94501059	644539.0	1	1000871	4014486473100
34	DRUM GEAR	609823.0	1	1001225	4014486497809
35	DRUM DRIVE	661220.0	1	1003340	4014486488807
35	DRUM DRIVE	661220.1	1	1003340	4014486488807
36	AT 6.0M - 9M	670224.1	1	1001158	4014486497380
40	FOR HPH - G CHOPPER	695610.0	1	No AP	
41	FOR HPH - G CHOPPER	680334.0	1	1001819	4014486488364
41	FOR HPH - G CHOPPER	680334.1	1	1001819	4014486488364

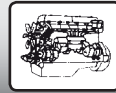
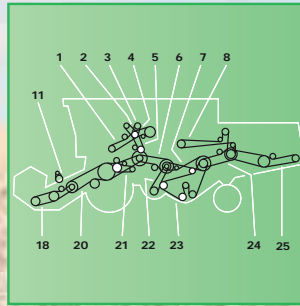
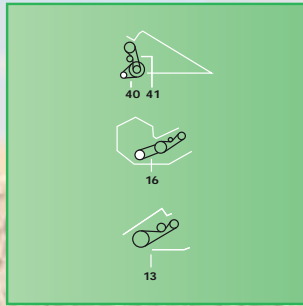
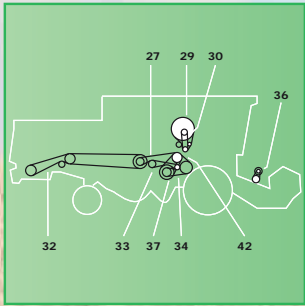

## CLAAS

42	TO NO. 94501058	644448.0	1	1000139	4014486461565
42	FOR SUCTION BLOWER FROM NO. 94501059	644537.0	1	1000140	4014486461572
	OM 441 A HYDRAULIC PUMP	633030.1	1	1000220	4014486462838
	ACCELERATOR	661031.2	1	1001564	4014486484663
	AT 4.5M - 5.1M	713506.1	1	1000315	4014486465310

### DOMINATOR 208 MEGA

0	STRAW CHOPPER	060306.2	1	1000723	4014486471151
0	STRAW CHOPPER DRIVE	060306.3	1	No AP	
0	STRAW CHOPPER	060306.4	1	1000723	4014486471151
0	STRAW CHOPPER DRIVE	060306.4	1	1000723	4014486471151
0	STRAW WALKER	506671.0	1	1000506	4014486467840
0	STRAW WALKER DRIVE	506671.0	1	1000506	4014486467840
0	STRAW WALKER	506671.1	1	1000506	4014486467840
0	STRAW WALKER DRIVE	506671.1	1	1000506	4014486467840
0	HYDRAULIC PUMP DRIVE (OM 441 A)	633030.0	1	1000220	4014486462838
0	OM 441 A HYDRAULIC PUMP	633030.0	1	1000220	4014486462838
0	ACCELERATOR	661031.2	1	1001564	4014486484663
0	AT 2 STAGE DRIVE	661220.0	1	1003340	4014486488807
0	AT N 650 - 1500 MIN-1	661220.0	1	1003340	4014486488807
0	FEEDER CHANNEL	661378.0	2	1000852	4014486472820
0	FEEDER HOUSING SHAFTS DISTANCE 1306MM	661378.0	2	1000852	4014486472820
0	AT 4.5M - 5.1M	713506.0	1	1000315	4014486465310
0	AT 4.5M - 5.1M	713506.2	1	1000315	4014486465310
1	TRAVEL DRIVE - OM 441 A	661239.0	1	1001244	4014486491999
1	OM 441 A GROUND DRIVE	661239.1	1	1001244	4014486491999
1	OM 366 LA GROUND DRIVE	661451.0	1	1001958	4014486490664
1	TRAVEL DRIVE - OM 366 LA	661451.0	1	1001958	4014486490664
2	HYDRAULIC PUMP DRIVE (OM 441 A)	633030.2	1	1000220	4014486462838
2	OM 441 A HYDRAULIC PUMP	633030.2	1	1000220	4014486462838
2	HYDRAULIC PUMP DRIVE (OM 366)	767057.1	1	1003333	4014486462609
2	OM 366 LA HYDRAULIC PUMP	767057.1	1	1003333	4014486462609
3	AIR CONDITIONING COMPRESSOR DRIVE - OM 366 LA	629908.0	1	1002332	4014486478631
3	OM 366 LA AIR CONDITIONING	629908.0	1	1002332	4014486478631
3	AIR CONDITIONING COMPRESSOR DRIVE - OM 366 LA	629908.1	1	1002332	4014486478631
3	OM 366 LA AIR CONDITIONING	629908.1	1	1002332	4014486478631
3	AIR CONDITIONING COMPRESSOR DRIVE - OM 441 A	661114.0	1	1002336	4014486478686
3	OM 441 A AIR CONDITIONING	661114.0	1	1002336	4014486478686
4	OM 366 LA GRAIN TANK	660409.0	1	1001575	4014486484809
4	TANK UNLOADING - OM 366 LA	660409.0	1	1001575	4014486484809
4	OM 441 A GRAIN TANK	661093.0	1	1001581	4014486484885
4	TANK UNLOADING - OM 441 A	661093.0	1	1001581	4014486484885
5	OM 441 A THRESHING MECHANISM	644403.0	1	1001247	4014486492033
5	THRESHING MACHINE - OM 441 A	644403.0	1	1001247	4014486492033
5	OM 366 LA THRESHING MECHANISM	644404.0	1	1003354	4014486490763
5	THRESHING MACHINE - OM 366 LA	644404.0	1	1003354	4014486490763
5	OM 366 LA THRESHING MECHANISM	644404.1	1	1003354	4014486490763
5	THRESHING MACHINE - OM 366 LA	644404.1	1	1003354	4014486490763
6	COUNTERSHAFT DRIVE	603337.0	1	1000662	4014486470260
6	GEAR	603337.0	1	1000662	4014486470260
7		644141.1	1	1000476	4014486467475
8		644447.0	1	1000420	4014486466836
8	FEED RAKE DRIVE	644447.0	1	1000420	4014486466836
11	AT 4.5M - 5.1M	670224.1	1	1001158	4014486497380
11	REEL DRIVE BY 4.5 M - 5.1 M	670224.1	1	1001158	4014486497380

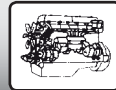

## CLAAS

13	FOR MULTIMASTER	629142.0	1	1001954	4014486490596
13	FOR CORN PICKER	692149.0	1	1001852	4014486488869
13	FOR MULTIMASTER	692149.0	1	1001852	4014486488869
13	FOR CORN PICKER	692150.0	1	1001857	4014486488920
13	FOR MULTIMASTER	692150.0	1	1001857	4014486488920
16	AT 6.0M - 9.0M	671013.1	1	1000676	4014486470482
16	REEL DRIVE BY 6.0 M - 9.0 M	671013.1	1	1000676	4014486470482
18	REEL DRIVE BY 4.5 M - 5.1 M	713506.0	1	1000315	4014486465310
18	REEL DRIVE BY 4.5 M - 5.1 M	713506.1	1	1000315	4014486465310
18	REEL DRIVE BY 4.5 M - 5.1 M	713506.2	1	1000315	4014486465310
20	SHAFTS DISTANCE 1463MM	644399.0	1	1000855	4014486472882
20	FEEDER CHANNEL	661378.1	2	1000852	4014486472820
20	FEEDER HOUSING SHAFTS DISTANCE 1306MM	661378.1	2	1000852	4014486472820
20	FEEDER HOUSING SHAFTS DISTANCE 1306MM	661378.2	2	1000852	4014486472820
21	ACCELERATOR	661031.0	1	1001564	4014486484663
21	FEEDER DRUM	661031.0	1	1001564	4014486484663
21	FEEDER DRUM	661031.1	1	1001564	4014486484663
21	FEEDER DRUM	661031.2	1	1001564	4014486484663
22	BLOWER DRIVE	603380.1	1	1001080	4014486498240
22	FAN	603380.1	1	1001080	4014486498240
23	SHAKER SHOE DRIVE	609762.0	1	1001713	4014486486919
23	SIEVE BOX	609762.0	1	1001713	4014486486919
24	STRAW WALKER	506671.2	1	1000506	4014486467840
24	STRAW WALKER DRIVE	506671.2	1	1000506	4014486467840
25	STRAW DISTRIBUTOR	623427.1	1	1000409	4014486466720
25	STRAW SPREADER	623427.1	1	1000409	4014486466720
27	STRAW CHOPPER DRIVE	060306.2	1	1000723	4014486471151
27	STRAW CHOPPER	060306.3	1	No AP	
30	COOLER	661345.0	1	1000160	4014486461824
30	RADIATOR SCREEN	661345.0	1	1000160	4014486461824
31	COUNTERSHAFT - OM 366 LA	661244.0	1	1000125	4014486461374
31	OM 366 LA INTERMEDIATE DRIVE	661244.0	1	1000125	4014486461374
31	COUNTERSHAFT - OM 441 A	661245.0	1	1003377	4014486461435
31	OM 441 A INTERMEDIATE DRIVE	661245.0	1	1003377	4014486461435
33	FOR CORN CHOPPER	061214.0	1	1000868	4014486473070
33	STRAW CHOPPER (MAIZE)	061214.0	1	1000868	4014486473070
33	FOR GRAIN CHOPPER	061353.0	1	1000870	4014486473094
33	STRAW CHOPPER (GRAIN)	061353.0	1	1000870	4014486473094
33	FOR GRAIN CHOPPER	061353.1	1	1000870	4014486473094
33	STRAW CHOPPER (GRAIN)	061353.1	1	1000870	4014486473094
34	DRUM GEAR	609823.0	1	1001225	4014486497809
34	DRUM-DRIVE	609823.0	1	1001225	4014486497809
35	AT N 510 - 1400 MIN-1	661298.0	1	1001630	4014486485738
35	REEL DRIVE BY N=510-1400 RPM	661298.0	1	1001630	4014486485738
36	AT 6.0M - 9.0M	670224.1	1	1001158	4014486497380
36	REEL DRIVE BY 6.0 M - 9.0 M	670224.1	1	1001158	4014486497380
40	CHOPPER DRIVE	695610.0	1	No AP	
40	FOR HPH - G CHOPPER	695610.0	1	No AP	
41	CHOPPER DRIVE	680334.0	1	1001819	4014486488364
41	FOR HPH - G CHOPPER	680334.0	1	1001819	4014486488364
41	CHOPPER DRIVE	680334.1	1	1001819	4014486488364
41	FOR HPH - G CHOPPER	680334.1	1	1001819	4014486488364
42	FOR AIR EXHAUST	644448.0	1	1000139	4014486461565
42	FOR SUCTION BLOWER	644448.0	1	1000139	4014486461565
	HYDRAULIC PUMP DRIVE (OM 441 A)	633030.1	1	1000220	4014486462838

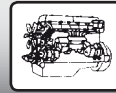
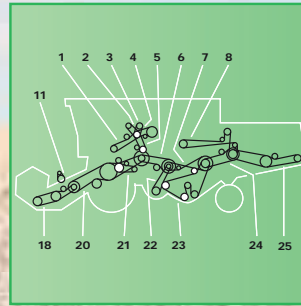
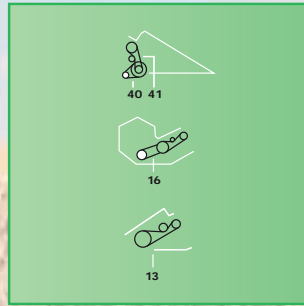
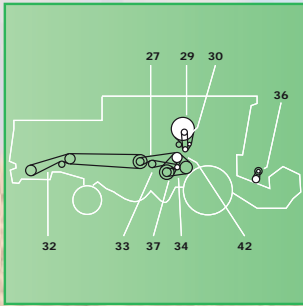

## CLAAS

	OM 441 A HYDRAULIC PUMP	633030.1	1	1000220	4014486462838
	ACCELERATOR	661031.1	1	1001564	4014486484663
	AT 2 STAGE DRIVE	661220.1	1	1003340	4014486488807
	AT N 650 - 1500 MIN-1	661220.1	1	1003340	4014486488807
	REEL DRIVE BY 2 - STEP GEAR	661220.1	1	1003340	4014486488807
	REEL DRIVE BY N=650-1500 RPM	661220.1	1	1003340	4014486488807
	FEEDER CHANNEL	661378.2	2	1000852	4014486472820
0	REEL BY 2 - STEP GEAR	661220.0	1	1003340	4014486488807
0	CHOPPER DRIVE	695610.0	1	No AP	

## DOMINATOR 218

0	STRAW CHOPPER	060306.2	1	1000723	4014486471151
0	AT 2 STAGE DRIVE	661220.0	1	1003340	4014486488807
0	AT N 650 - 1500 MIN-1	661220.0	1	1003340	4014486488807
0	RADIATOR SCREEN	661345.0	1	1000160	4014486461824
0	AT 4.5M - 5.1M	713506.2	1	1000315	4014486465310
1	OM 441 A GROUND DRIVE	661239.1	1	1001244	4014486491999
1	OM 366 LA GROUND DRIVE	661451.0	1	1001958	4014486490664
2	OM 441 A HYDRAULIC PUMP	633030.2	1	1000220	4014486462838
2	OM 366 LA HYDRAULIC PUMP	767057.1	1	1003333	4014486462609
3	OM 366 LA AIR CONDITIONING	629908.0	1	1002332	4014486478631
3	OM 366 LA AIR CONDITIONING	629908.1	1	1002332	4014486478631
3	OM 441 A AIR CONDITIONING	661114.0	1	1002336	4014486478686
4	OM 366 LA GRAIN TANK	660409.0	1	1001575	4014486484809
4	OM 441 A GRAIN TANK	661093.0	1	1001581	4014486484885
5	OM 441 A THRESHING MECHANISM	644403.0	1	1001247	4014486492033
5	OM 366 LA THRESHING MECHANISM	644404.0	1	1003354	4014486490763
5	OM 366 LA THRESHING MECHANISM	644404.1	1	1003354	4014486490763
6	GEAR	603337.0	1	1000662	4014486470260
7		644141.1	1	1000476	4014486467475
8	FEED RAKE DRIVE	644447.0	1	1000420	4014486466836
11	AT 4.5M - 5.1M	670224.1	1	1001158	4014486497380
13	FOR MULTIMASTER	629142.0	1	1001954	4014486490596
13	FOR CORN PICKER	692149.0	1	1001852	4014486488869
13	FOR CORN PICKER	692150.0	1	1001857	4014486488920
16	AT 6.0M - 9.0M	671013.1	1	1000676	4014486470482
20	SHAFTS DISTANCE 1463MM	644399.0	1	1000855	4014486472882
20	FEEDER HOUSING SHAFTS DISTANCE 1306MM	661378.1	2	1000852	4014486472820
21	ACCELERATOR	661031.0	1	1001564	4014486484663
22	FAN	603380.1	1	1001080	4014486498240
23	SIEVE BOX	609762.0	1	1001713	4014486486919
24	STRAW WALKER	506671.2	1	1000506	4014486467840
25	STRAW SPREADER	623427.1	1	1000409	4014486466720
27	STRAW CHOPPER	060306.3	1	No AP	
31	OM 366 LA INTERMEDIATE DRIVE	661244.0	1	1000125	4014486461374
31	OM 441 A INTERMEDIATE DRIVE	661245.0	1	1003377	4014486461435
33	FOR CORN CHOPPER	061214.0	1	1000868	4014486473070
33	FOR GRAIN CHOPPER	061353.0	1	1000870	4014486473094
33	FOR GRAIN CHOPPER	061353.1	1	1000870	4014486473094
34	DRUM GEAR	609823.0	1	1001225	4014486497809
35	AT N 510 - 1400 MIN-1	661298.0	1	1001630	4014486485738
36	AT 6.0M - 9.0M	670224.1	1	1001158	4014486497380
40	FOR HPH - G CHOPPER	695610.0	1	No AP	
41	FOR HPH - G CHOPPER	680334.0	1	1001819	4014486488364
41	FOR HPH - G CHOPPER	680334.1	1	1001819	4014486488364





# CLAAS

42	FOR SUCTION BLOWER	644448.0	1	1000139	4014486461565
<b>DOMINATOR 218 II MEGA</b>					
0	TO NO. 94501058	060306.2	1	1000723	4014486471151
0	TO NO. 94501058	060306.4	1	1000723	4014486471151
0	STRAW WALKER	506671.0	1	1000506	4014486467840
0	STRAW WALKER	506671.1	1	1000506	4014486467840
0	OM 441 A HYDRAULIC PUMP	633030.0	1	1000220	4014486462838
0	FEEDER CHANNEL	644368.1	2	1000858	4014486472929
0	ACCELERATOR	661031.3	1	1001564	4014486484663
0	RADIATOR SCREEN	661345.0	1	1000160	4014486461824
0	AT 4.5M - 5.1M	713506.0	1	1000315	4014486465310
0	AT 4.5M - 5.1M	713506.2	1	1000315	4014486465310
1	OM 441 A GROUND DRIVE	661239.1	1	1001244	4014486491999
1	OM 366 LA GROUND DRIVE	661451.0	1	1001958	4014486490664
2	OM 441 A HYDRAULIC PUMP	633030.2	1	1000220	4014486462838
2	OM 366 LA HYDRAULIC PUMP	767057.1	1	1003333	4014486462609
3	OM 366 LA AIR CONDITIONING	629908.0	1	1002332	4014486478631
3	OM 366 LA AIR CONDITIONING	629908.1	1	1002332	4014486478631
3	OM 441 A AIR CONDITIONING	661114.0	1	1002336	4014486478686
4	OM 366 LA GRAIN TANK	660409.0	1	1001575	4014486484809
4	OM 441 A GRAIN TANK	661093.0	1	1001581	4014486484885
5	OM 441 A THRESHING MECHANISM	644403.0	1	1001247	4014486492033
5	OM 366 LA THRESHING MECHANISM	644404.0	1	1003354	4014486490763
5	OM 366 LA THRESHING MECHANISM	644404.1	1	1003354	4014486490763
6	GEAR	603337.0	1	1000662	4014486470260
7		644141.1	1	1000476	4014486467475
8	FEED RAKE DRIVE	644447.0	1	1000420	4014486466836
11	AT 4.5M - 5.1M	670224.1	1	1001158	4014486497380
13	FOR MULTIMASTER	629142.0	1	1001954	4014486490596
13	FOR CORN PICKER	692149.0	1	1001852	4014486488869
13	FOR CORN PICKER	692150.0	1	1001857	4014486488920
16	AT 6.0M - 9M	671013.1	1	1000676	4014486470482
20	FEEDER CHANNEL	644368.0	2	1000858	4014486472929
21	ACCELERATOR	661031.1	1	1001564	4014486484663
22	FAN	603380.1	1	1001080	4014486498240
23	SIEVE BOX	609762.0	1	1001713	4014486486919
24	STRAW WALKER	506671.2	1	1000506	4014486467840
25	STRAW SPREADER	623427.1	1	1000409	4014486466720
27	TO NO. 94501058	060306.3	1	No AP	
27	STRAW CHOPPER FROM NO. 94501059	644538.0	1	1001655	4014486486094
31	OM 366 LA INTERMEDIATE DRIVE	661244.0	1	1000125	4014486461374
31	OM 441 A INTERMEDIATE DRIVE	661245.0	1	1003377	4014486461435
33	FOR CORN CHOPPER	061214.0	1	1000868	4014486473070
33	FOR GRAIN CHOPPER TO NO. 94501058	061353.0	1	1000870	4014486473094
33	FOR GRAIN CHOPPER TO NO. 94501058	061353.1	1	1000870	4014486473094
33	FOR GRAIN CHOPPER FROM NO. 94501059	644539.0	1	1000871	4014486473100
34	DRUM GEAR	609823.0	1	1001225	4014486497809
35	DRUM DRIVE	661220.0	1	1003340	4014486488807
35	DRUM DRIVE	661220.1	1	1003340	4014486488807
36	AT 6.0M - 9M	670224.1	1	1001158	4014486497380
40	FOR HPH - G CHOPPER	695610.0	1	No AP	
41	FOR HPH - G CHOPPER	680334.0	1	1001819	4014486488364
41	FOR HPH - G CHOPPER	680334.1	1	1001819	4014486488364
42	TO NO. 94501058	644448.0	1	1000139	4014486461565

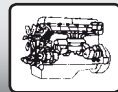

## CLAAS

42	FOR SUCTION BLOWER FROM NO. 94501059	644537.0	1	1000140	4014486461572
	OM 441 A HYDRAULIC PUMP	633030.1	1	1000220	4014486462838
	ACCELERATOR	661031.2	1	1001564	4014486484663
	AT 4.5M - 5.1M	713506.1	1	1000315	4014486465310
<b>DOMINATOR 218 MEGA</b>					
0	STRAW CHOPPER DRIVE	060306.3	1	No AP	
0	STRAW CHOPPER	060306.4	1	1000723	4014486471151
0	STRAW CHOPPER DRIVE	060306.4	1	1000723	4014486471151
0	STRAW WALKER	506671.0	1	1000506	4014486467840
0	STRAW WALKER DRIVE	506671.0	1	1000506	4014486467840
0	STRAW WALKER	506671.1	1	1000506	4014486467840
0	STRAW WALKER DRIVE	506671.1	1	1000506	4014486467840
0	HYDRAULIC PUMP DRIVE (OM 441 A)	633030.0	1	1000220	4014486462838
0	OM 441 A HYDRAULIC PUMP	633030.0	1	1000220	4014486462838
0	SHAFTS DISTANCE 1463MM	644399.0	1	1000855	4014486472882
0	ACCELERATOR	661031.2	1	1001564	4014486484663
0	OM 441 A GROUND DRIVE	661239.1	1	1001244	4014486491999
0	FEEDER CHANNEL	661378.0	2	1000852	4014486472820
0	FEEDER HOUSING SHAFTS DISTANCE 1306MM	661378.0	2	1000852	4014486472820
0	AT 4.5M - 5.1M	713506.0	1	1000315	4014486465310
1	TRAVEL DRIVE - OM 441 A	661239.0	1	1001244	4014486491999
1	TRAVEL DRIVE - OM 366 LA	661451.0	1	1001958	4014486490664
2	HYDRAULIC PUMP DRIVE (OM 441 A)	633030.2	1	1000220	4014486462838
2	HYDRAULIC PUMP DRIVE (OM 366)	767057.1	1	1003333	4014486462609
3	AIR CONDITIONING COMPRESSOR DRIVE - OM 366 LA	629908.0	1	1002332	4014486478631
3	AIR CONDITIONING COMPRESSOR DRIVE - OM 366 LA	629908.1	1	1002332	4014486478631
3	AIR CONDITIONING COMPRESSOR DRIVE - OM 441 A	661114.0	1	1002336	4014486478686
4	TANK UNLOADING - OM 366 LA	660409.0	1	1001575	4014486484809
4	TANK UNLOADING - OM 441 A	661093.0	1	1001581	4014486484885
5	THRESHING MACHINE - OM 441 A	644403.0	1	1001247	4014486492033
5	THRESHING MACHINE - OM 366 LA	644404.0	1	1003354	4014486490763
5	THRESHING MACHINE - OM 366 LA	644404.1	1	1003354	4014486490763
6	COUNTERSHAFT DRIVE	603337.0	1	1000662	4014486470260
7		644141.1	1	1000476	4014486467475
8		644447.0	1	1000420	4014486466836
11	REEL DRIVE BY 4.5 M - 5.1 M	670224.1	1	1001158	4014486497380
13	FOR MULTIMASTER	629142.0	1	1001954	4014486490596
13	FOR MULTIMASTER	692149.0	1	1001852	4014486488869
13	FOR MULTIMASTER	692150.0	1	1001857	4014486488920
16	REEL DRIVE BY 6.0 M - 9.0 M	671013.1	1	1000676	4014486470482
18	REEL DRIVE BY 4.5 M - 5.1 M	713506.0	1	1000315	4014486465310
18	REEL DRIVE BY 4.5 M - 5.1 M	713506.1	1	1000315	4014486465310
18	REEL DRIVE BY 4.5 M - 5.1 M	713506.2	1	1000315	4014486465310
20	FEEDER CHANNEL	661378.1	2	1000852	4014486472820
20	FEEDER HOUSING SHAFTS DISTANCE 1306MM	661378.2	2	1000852	4014486472820
21	FEEDER DRUM	661031.0	1	1001564	4014486484663
21	FEEDER DRUM	661031.1	1	1001564	4014486484663
21	FEEDER DRUM	661031.2	1	1001564	4014486484663
22	BLOWER DRIVE	603380.1	1	1001080	4014486498240
23	SHAKER SHOE DRIVE	609762.0	1	1001713	4014486486919
24	STRAW WALKER DRIVE	506671.2	1	1000506	4014486467840
25	STRAW DISTRIBUTOR	623427.1	1	1000409	4014486466720
27	STRAW CHOPPER DRIVE	060306.2	1	1000723	4014486471151
30	COOLER	661345.0	1	1000160	4014486461824



## CLAAS

31	COUNTERSHAFT - OM 366 LA	661244.0	1	1000125	4014486461374
31	COUNTERSHAFT - OM 441 A	661245.0	1	1003377	4014486461435
33	STRAW CHOPPER (MAIZE)	061214.0	1	1000868	4014486473070
33	STRAW CHOPPER (GRAIN)	061353.0	1	1000870	4014486473094
33	STRAW CHOPPER (GRAIN)	061353.1	1	1000870	4014486473094
34	DRUM-DRIVE	609823.0	1	1001225	4014486497809
35	REEL DRIVE BY N=510-1400 RPM	661298.0	1	1001630	4014486485738
36	REEL DRIVE BY 6.0 M - 9.0 M	670224.1	1	1001158	4014486497380
40	CHOPPER DRIVE	695610.0	1	No AP	
41	CHOPPER DRIVE	680334.0	1	1001819	4014486488364
41	CHOPPER DRIVE	680334.1	1	1001819	4014486488364
42	FOR AIR EXHAUST	644448.0	1	1000139	4014486461565
	HYDRAULIC PUMP DRIVE (OM 441 A)	633030.1	1	1000220	4014486462838
	OM 441 A HYDRAULIC PUMP	633030.1	1	1000220	4014486462838
	ACCELERATOR	661031.1	1	1001564	4014486484663
	AT 2 STAGE DRIVE	661220.1	1	1003340	4014486488807
	AT N 650 - 1500 MIN-1	661220.1	1	1003340	4014486488807
	REEL DRIVE BY 2 - STEP GEAR	661220.1	1	1003340	4014486488807
	REEL DRIVE BY N=650-1500 RPM	661220.1	1	1003340	4014486488807
	FEEDER CHANNEL	661378.2	2	1000852	4014486472820
0	REEL BY 2 - STEP GEAR	661220.0	1	1003340	4014486488807
0	CHOPPER DRIVE	695610.0	1	No AP	

## DOMINATOR 350 MEGA

0	FOR N=519 RPM	066034.0	1	1000302	4014486465037
0		506671.0	1	1000506	4014486467840
0		506671.1	1	1000506	4014486467840
0		545668.2	1	1004356	4014486714005
0		644369.1	2	1002873	4014486472851
0		755070.0	2	1002795	4014486463279
0		755070.2	2	1002795	4014486463279
1		644016.1	1	1001800	4014486488104
2	FOR THRESHING	629002.0	1	1003395	4014486462715
2	FOR THRESHING	629002.1	1	1003395	4014486462715
2		656028.0	1	1003335	4014486462869
3		621903.0	1	1002041	4014486475166
3		621903.1	1	1002041	4014486475166
4		544166.0	1	1003360	4014486484830
5		544164.0	1	1001969	4014486490800
6		603337.0	1	1000662	4014486470260
6	FOR THRESHING	667238.0	1	1000693	4014486470741
7		644141.1	1	1000476	4014486467475
8		644447.0	1	1000420	4014486466836
9		623427.1	1	1000409	4014486466720
10		755070.1	2	1002795	4014486463279
11	FOR N=660 RPM	785341.0	1	1000295	4014486464870
12		644369.0	2	1002873	4014486472851
13		644539.0	1	1000871	4014486473100
14		603380.1	1	1001080	4014486498240
15		609762.0	1	1001713	4014486486919
17		644538.0	1	1001655	4014486486094
19		506671.2	1	1000506	4014486467840
20		545689.0	1	1003332	4014486461886
21		545668.1	1	1000119	4014486461305
22		644537.0	1	1000140	4014486461572



## CLAAS

23	TWO STAGE DRIVE	661427.0	1	1001228	4014486497847
24	DRUM DRIVE VARIABLE SPEED (N=650-1500 RPM)	661220.0	1	1003340	4014486488807
24	DRUM DRIVE VARIABLE SPEED (N=650-1500 RPM)	661220.1	1	1003340	4014486488807

### DOMINATOR 350 MEGA TYP 835

0	N = 519 MIN-1	066034.0	1	1000302	4014486465037
0		506671.0	1	1000506	4014486467840
0		506671.1	1	1000506	4014486467840
0	TO NO. 83500255	545668.2	1	1004356	4014486714005
0	ALTERNATOR FROM NR. 83500255	545954.0	1	1002646	4014486480849
0		644369.1	2	1002873	4014486472851
0		755070.0	2	1002795	4014486463279
0		755070.2	2	1002795	4014486463279
0	ALTERNATOR FROM NO. 83500256	796998.0	1	1003945	4014486481969
1		644016.1	1	1001800	4014486488104
2	WHEN THRESHING	629002.0	1	1003395	4014486462715
2	WHEN THRESHING	629002.1	1	1003395	4014486462715
2		656028.0	1	1003335	4014486462869
3		621903.0	1	1002041	4014486475166
3		621903.1	1	1002041	4014486475166
4		544166.0	1	1003360	4014486484830
5		544164.0	1	1001969	4014486490800
6		603337.0	1	1000662	4014486470260
6	WHEN THRESHING	667238.0	1	1000693	4014486470741
7		644141.1	1	1000476	4014486467475
8		644447.0	1	1000420	4014486466836
9		623427.1	1	1000409	4014486466720
10		755070.1	2	1002795	4014486463279
11	N = 660 MIN-1	785341.0	1	1000295	4014486464870
12		644369.0	2	1002873	4014486472851
13		544172.0	1	1001745	4014486487299
14		603380.1	1	1001080	4014486498240
15		609762.0	1	1001713	4014486486919
17		644538.0	1	1001655	4014486486094
19		506671.2	1	1000506	4014486467840
20	TO NO. 83500255	545689.0	1	1003332	4014486461886
20	FROM NO. 83500256	821734.2	1	1000154	4014486461763
21	TO NO. 83500255	545668.1	1	1000119	4014486461305
22		644537.0	1	1000140	4014486461572
23	TWO STAGE DRIVE	661427.0	1	1001228	4014486497847
24	DRUM VARIABLE SPEED N = 650 · 1500	661220.0	1	1003340	4014486488807
24	DRUM VARIABLE SPEED N = 650 · 1500	661220.1	1	1003340	4014486488807

### DOMINATOR 350 MEGA TYP 836

0	N = 519 MIN-1	066034.0	1	1000302	4014486465037
0		506671.0	1	1000506	4014486467840
0		506671.1	1	1000506	4014486467840
0	TO NO. 83500255	545668.2	1	1004356	4014486714005
0	ALTERNATOR FROM NR. 83500255	545954.0	1	1002646	4014486480849
0		644369.1	2	1002873	4014486472851
0		755070.0	2	1002795	4014486463279
0		755070.2	2	1002795	4014486463279
0	ALTERNATOR FROM NO. 83500256	796998.0	1	1003945	4014486481969
1		644016.1	1	1001800	4014486488104
2	WHEN THRESHING	629002.0	1	1003395	4014486462715

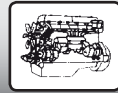

## CLAAS

2	WHEN THRESHING	629002.1	1	1003395	4014486462715
2		656028.0	1	1003335	4014486462869
3		621903.0	1	1002041	4014486475166
3		621903.1	1	1002041	4014486475166
4		544166.0	1	1003360	4014486484830
5		544164.0	1	1001969	4014486490800
6		603337.0	1	1000662	4014486470260
6	WHEN THRESHING	667238.0	1	1000693	4014486470741
7		644141.1	1	1000476	4014486467475
8		644447.0	1	1000420	4014486466836
9		623427.1	1	1000409	4014486466720
10		755070.1	2	1002795	4014486463279
11	N = 660 MIN-1	785341.0	1	1000295	4014486464870
12		644369.0	2	1002873	4014486472851
13		544172.0	1	1001745	4014486487299
14		603380.1	1	1001080	4014486498240
15		609762.0	1	1001713	4014486486919
17		644538.0	1	1001655	4014486486094
19		506671.2	1	1000506	4014486467840
20	TO NO. 83500255	545689.0	1	1003332	4014486461886
20	FROM NO. 83500256	821734.2	1	1000154	4014486461763
21	TO NO. 83500255	545668.1	1	1000119	4014486461305
22		644537.0	1	1000140	4014486461572
23	TWO STAGE DRIVE	661427.0	1	1001228	4014486497847
24	DRUM VARIABLE SPEED DRIVE N = 650 - 1500	661220.0	1	1003340	4014486488807
24	DRUM VARIABLE SPEED DRIVE N = 650 - 1500	661220.1	1	1003340	4014486488807

### DOMINATOR 360 MEGA

0		066034.0	1	1000302	4014486465037
0		506671.0	1	1000506	4014486467840
0		506671.1	1	1000506	4014486467840
0	TO NR. 84500261	545668.2	1	1004356	4014486714005
0	ALTERNATOR DRIVE (TILL NR. 84500261)	545954.0	1	1002646	4014486480849
0		644368.1	2	1000858	4014486472929
0		755070.0	2	1002795	4014486463279
0		755070.2	2	1002795	4014486463279
0	ALTERNATOR DRIVE (FROM NR. 84500262)	796998.0	1	1003945	4014486481969
1		544049.1	2	1001561	4014486484618
2		629002.0	1	1003395	4014486462715
2		629002.1	1	1003395	4014486462715
2		656028.0	1	1003335	4014486462869
3		621903.0	1	1002041	4014486475166
3		621903.1	1	1002041	4014486475166
4		544166.0	1	1003360	4014486484830
5		544164.0	1	1001969	4014486490800
6		603337.0	1	1000662	4014486470260
6		667238.0	1	1000693	4014486470741
7		644141.1	1	1000476	4014486467475
8		644447.0	1	1000420	4014486466836
9		623427.1	1	1000409	4014486466720
10		755070.1	2	1002795	4014486463279
11		785341.0	1	1000295	4014486464870
12		644368.0	2	1000858	4014486472929
13		544172.0	1	1001745	4014486487299
14		603380.1	1	1001080	4014486498240

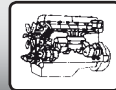

## CLAAS

15		609762.0	1	1001713	4014486486919
17		644538.0	1	1001655	4014486486094
19		506671.2	1	1000506	4014486467840
20	TO NR. 84500261	545689.0	1	1003332	4014486461886
20	FROM NR. 84500262	821734.2	1	1000154	4014486461763
21	TO NR. 84500261	545668.1	1	1000119	4014486461305
22		644537.0	1	1000140	4014486461572
23	TO NR. 84500386 HIGH - LOW SPEED	609823.0	1	1001225	4014486497809
23	FROM NR. 84500387	661427.0	1	1001228	4014486497847
24	DRUM DRIVE VARIABLE SPEED (N=650-1500 RPM)	661220.0	1	1003340	4014486488807
24	DRUM DRIVE VARIABLE SPEED (N=650-1500 RPM)	661220.1	1	1003340	4014486488807

### DOMINATOR 360 MEGA TYP 845

0	N = 519 MIN-1	066034.0	1	1000302	4014486465037
0		506671.0	1	1000506	4014486467840
0		506671.1	1	1000506	4014486467840
0	TO NO. 84500261	545668.2	1	1004356	4014486714005
0	ALTERNATOR FROM NR. 84500261	545954.0	1	1002646	4014486480849
0		644368.1	2	1000858	4014486472929
0		755070.0	2	1002795	4014486463279
0		755070.2	2	1002795	4014486463279
0	ALTERNATOR FROM NO. 84500262	796998.0	1	1003945	4014486481969
1	1 SET = 2 BELTS	544049.1	2	1001561	4014486484618
2	WHEN THRESHING	629002.0	1	1003395	4014486462715
2	WHEN THRESHING	629002.1	1	1003395	4014486462715
2		656028.0	1	1003335	4014486462869
3		621903.0	1	1002041	4014486475166
3		621903.1	1	1002041	4014486475166
4		544166.0	1	1003360	4014486484830
5		544164.0	1	1001969	4014486490800
6		603337.0	1	1000662	4014486470260
6	WHEN THRESHING	667238.0	1	1000693	4014486470741
7		644141.1	1	1000476	4014486467475
8		644447.0	1	1000420	4014486466836
9		623427.1	1	1000409	4014486466720
10		755070.1	2	1002795	4014486463279
11	N = 660 MIN-1	785341.0	1	1000295	4014486464870
12		644368.0	2	1000858	4014486472929
13		544172.0	1	1001745	4014486487299
14		603380.1	1	1001080	4014486498240
15		609762.0	1	1001713	4014486486919
17		644538.0	1	1001655	4014486486094
19		506671.2	1	1000506	4014486467840
20	TO NO. 84500261	545689.0	1	1003332	4014486461886
20	FROM NO. 84500262	821734.2	1	1000154	4014486461763
21	TO NO. 84500261	545668.1	1	1000119	4014486461305
22		644537.0	1	1000140	4014486461572
23	TO NO. 84500386 HIGH - LOW SPEED RANGE TRANSMISSION	609823.0	1	1001225	4014486497809
23	FROM NO. 84500387	661427.0	1	1001228	4014486497847
24	DRUM VARIABLE SPEED DRIVE N = 650 - 1500	661220.0	1	1003340	4014486488807
24	DRUM VARIABLE SPEED DRIVE N = 650 - 1500	661220.1	1	1003340	4014486488807

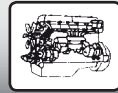

# CLAAS

## DOMINATOR 360 MEGA TYP 846

0	N = 519 MIN-1	066034.0	1	1000302	4014486465037
0		506671.0	1	1000506	4014486467840
0		506671.1	1	1000506	4014486467840
0	TO NO. 84500261	545668.2	1	1004356	4014486714005
0	ALTERNATOR FROM NR. 84500261	545954.0	1	1002646	4014486480849
0		644368.1	2	1000858	4014486472929
0		755070.0	2	1002795	4014486463279
0		755070.2	2	1002795	4014486463279
0	ALTERNATOR FROM NO. 84500262	796998.0	1	1003945	4014486481969
1	1 SET = 2 BELTS	544049.1	2	1001561	4014486484618
2	WHEN THRESHING	629002.0	1	1003395	4014486462715
2	WHEN THRESHING	629002.1	1	1003395	4014486462715
2		656028.0	1	1003335	4014486462869
3		621903.0	1	1002041	4014486475166
3		621903.1	1	1002041	4014486475166
4		544166.0	1	1003360	4014486484830
5		544164.0	1	1001969	4014486490800
6		603337.0	1	1000662	4014486470260
6	WHEN THRESHING	667238.0	1	1000693	4014486470741
7		644141.1	1	1000476	4014486467475
8		644447.0	1	1000420	4014486466836
9		623427.1	1	1000409	4014486466720
10		755070.1	2	1002795	4014486463279
11		785341.0	1	1000295	4014486464870
12		644368.0	2	1000858	4014486472929
13		544172.0	1	1001745	4014486487299
14		603380.1	1	1001080	4014486498240
15		609762.0	1	1001713	4014486486919
17		644538.0	1	1001655	4014486486094
19		506671.2	1	1000506	4014486467840
20	TO NO. 84500261	545689.0	1	1003332	4014486461886
20	FROM NO. 84500262	821734.2	1	1000154	4014486461763
21	TO NO. 84500261	545668.1	1	1000119	4014486461305
22		644537.0	1	1000140	4014486461572
23	TO NO. 84500386 HIGH - LOW SPEED RANGE TRANSMISSION	609823.0	1	1001225	4014486497809
23	FROM NO. 84500387	661427.0	1	1001228	4014486497847
24	DRUM VARIABLE SPEED DRIVE N = 650 - 1500	661220.0	1	1003340	4014486488807
24	DRUM VARIABLE SPEED DRIVE N = 650 - 1500	661220.1	1	1003340	4014486488807

## DOMINATOR 360 MEGA TYP C12

0	N = 519 MIN-1	066034.0	1	1000302	4014486465037
0		506671.0	1	1000506	4014486467840
0		506671.1	1	1000506	4014486467840
0	TO NO. 84500261	545668.2	1	1004356	4014486714005
0	ALTERNATOR FROM NR. 84500261	545954.0	1	1002646	4014486480849
0		644368.1	2	1000858	4014486472929
0		755070.0	2	1002795	4014486463279
0		755070.2	2	1002795	4014486463279
0	ALTERNATOR FROM NO. 84500262	796998.0	1	1003945	4014486481969
1	1 SET = 2 BELTS	544049.1	2	1001561	4014486484618
2	WHEN THRESHING	629002.0	1	1003395	4014486462715
2	WHEN THRESHING	629002.1	1	1003395	4014486462715
2		656028.0	1	1003335	4014486462869



## CLAAS

3		621903.0	1	1002041	4014486475166
3		621903.1	1	1002041	4014486475166
4		544166.0	1	1003360	4014486484830
5		544164.0	1	1001969	4014486490800
6		603337.0	1	1000662	4014486470260
6	WHEN THRESHING	667238.0	1	1000693	4014486470741
7		644141.1	1	1000476	4014486467475
8		644447.0	1	1000420	4014486466836
9		623427.1	1	1000409	4014486466720
10		755070.1	2	1002795	4014486463279
11	N = 660 MIN-1	785341.0	1	1000295	4014486464870
12		644368.0	2	1000858	4014486472929
13		544172.0	1	1001745	4014486487299
14		603380.1	1	1001080	4014486498240
15		609762.0	1	1001713	4014486486919
17		644538.0	1	1001655	4014486486094
19		506671.2	1	1000506	4014486467840
20	TO NO. 84500261	545689.0	1	1003332	4014486461886
20	FROM NO. 84500262	821734.2	1	1000154	4014486461763
21	TO NO. 84500261	545668.1	1	1000119	4014486461305
22		644537.0	1	1000140	4014486461572
23	TO NO. 84500386 HIGH - LOW SPEED RANGE TRANSMISSION	609823.0	1	1001225	4014486497809
23	FROM NO. 84500387	661427.0	1	1001228	4014486497847
24	DRUM VARIABLE SPEED DRIVE N = 650 - 1500	661220.0	1	1003340	4014486488807
24	DRUM VARIABLE SPEED DRIVE N = 650 - 1500	661220.1	1	1003340	4014486488807

## DOMINATOR 370

0		066034.0	1	1000302	4014486465037
0	ALTERNATOR DRIVE (TILL NR. 84500261)	545954.0	1	1002646	4014486480849
0	ALTERNATOR DRIVE (FROM NR. 84500262)	796998.0	1	1003945	4014486481969
1		544049.1	2	1001561	4014486484618
2		629002.0	1	1003395	4014486462715
2		629002.1	1	1003395	4014486462715
2		656028.0	1	1003335	4014486462869
3		621903.0	1	1002041	4014486475166
3		621903.1	1	1002041	4014486475166
4		544166.0	1	1003360	4014486484830
5		544164.0	1	1001969	4014486490800
6		603337.0	1	1000662	4014486470260
6		667238.0	1	1000693	4014486470741
7		644141.1	1	1000476	4014486467475
8		644447.0	1	1000420	4014486466836
9		623427.1	1	1000409	4014486466720
10		755070.1	2	1002795	4014486463279
11		785341.0	1	1000295	4014486464870
12		644368.0	2	1000858	4014486472929
13		544172.0	1	1001745	4014486487299
14		603380.1	1	1001080	4014486498240
15		609762.0	1	1001713	4014486486919
17		644538.0	1	1001655	4014486486094
19		506671.2	1	1000506	4014486467840
20	TO NR. 84500261	545689.0	1	1003332	4014486461886
20	FROM NR. 84500262	821734.2	1	1000154	4014486461763
21	TO NR. 84500261	545668.1	1	1000119	4014486461305
22		644537.0	1	1000140	4014486461572



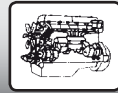

## CLAAS

23	TO NR. 84500386 HIGH - LOW SPEED	609823.0	1	1001225	4014486497809
23	FROM NR. 84500387	661427.0	1	1001228	4014486497847
24	DRUM DRIVE VARIABLE SPEED (N=650-1500 RPM)	661220.0	1	1003340	4014486488807
24	DRUM DRIVE VARIABLE SPEED (N=650-1500 RPM)	661220.1	1	1003340	4014486488807

### DOMINATOR 370 MEGA

0		066034.0	1	1000302	4014486465037
0		506671.0	1	1000506	4014486467840
0		506671.1	1	1000506	4014486467840
0		506671.2	1	1000506	4014486467840
0		544049.1	2	1001561	4014486484618
0		544166.0	1	1003360	4014486484830
0		544172.0	1	1001745	4014486487299
0	TO NR. 84500261	545668.1	1	1000119	4014486461305
0	TO NR. 84500261	545668.2	1	1004356	4014486714005
0	TO NR. 84500261	545689.0	1	1003332	4014486461886
0	ALTERNATOR DRIVE (TILL NR. 84500261)	545954.0	1	1002646	4014486480849
0		603337.0	1	1000662	4014486470260
0		603380.1	1	1001080	4014486498240
0		609762.0	1	1001713	4014486486919
0	TO NR. 84500386 HIGH - LOW SPEED	609823.0	1	1001225	4014486497809
0		621903.1	1	1002041	4014486475166
0		623427.1	1	1000409	4014486466720
0		629002.1	1	1003395	4014486462715
0		644141.1	1	1000476	4014486467475
0		644368.0	2	1000858	4014486472929
0		644368.1	2	1000858	4014486472929
0		644447.0	1	1000420	4014486466836
0		644537.0	1	1000140	4014486461572
0		644538.0	1	1001655	4014486486094
0		656028.0	1	1003335	4014486462869
0	DRUM DRIVE VARIABLE SPEED (N=650-1500 RPM)	661220.1	1	1003340	4014486488807
0	FROM NR. 84500387	661427.0	1	1001228	4014486497847
0		667238.0	1	1000693	4014486470741
0		755070.0	2	1002795	4014486463279
0		755070.1	2	1002795	4014486463279
0		755070.2	2	1002795	4014486463279
0		785341.0	1	1000295	4014486464870
0	ALTERNATOR DRIVE (FROM NR. 84500262)	796998.0	1	1003945	4014486481969
0	FROM NR. 84500262	821734.2	1	1000154	4014486461763
5		544164.0	1	1001969	4014486490800

### DOMINATOR 370 MEGA TYP 845

0	N = 519 MIN-1	066034.0	1	1000302	4014486465037
0		506671.0	1	1000506	4014486467840
0		506671.1	1	1000506	4014486467840
0		506671.2	1	1000506	4014486467840
0	1 SET = 2 BELTS	544049.1	2	1001561	4014486484618
0		544166.0	1	1003360	4014486484830
0		544172.0	1	1001745	4014486487299
0	TO NO. 84500261	545668.1	1	1000119	4014486461305
0	TO NO. 84500261	545668.2	1	1004356	4014486714005
0	TO NO. 84500261	545689.0	1	1003332	4014486461886
0	ALTERNATOR FROM NR. 84500261	545954.0	1	1002646	4014486480849
0		603337.0	1	1000662	4014486470260



## CLAAS

0		603380.1	1	1001080	4014486498240
0		609762.0	1	1001713	4014486486919
0	TO NO. 84500386 HIGH - LOW SPEED RANGE TRANSMISSION	609823.0	1	1001225	4014486497809
0		621903.1	1	1002041	4014486475166
0		623427.1	1	1000409	4014486466720
0	WHEN THRESHING	629002.1	1	1003395	4014486462715
0		644141.1	1	1000476	4014486467475
0		644368.0	2	1000858	4014486472929
0		644368.1	2	1000858	4014486472929
0		644447.0	1	1000420	4014486466836
0		644537.0	1	1000140	4014486461572
0		644538.0	1	1001655	4014486486094
0		656028.0	1	1003335	4014486462869
0	DRUM VARIABLE SPEED DRIVE N = 650 - 1500	661220.1	1	1003340	4014486488807
0	FROM NO. 84500387	661427.0	1	1001228	4014486497847
0	WHEN THRESHING	667238.0	1	1000693	4014486470741
0		755070.0	2	1002795	4014486463279
0		755070.1	2	1002795	4014486463279
0		755070.2	2	1002795	4014486463279
0	N = 660 MIN-1	785341.0	1	1000295	4014486464870
0	ALTERNATOR FROM NO. 84500262	796998.0	1	1003945	4014486481969
0	FROM NO. 84500262	821734.2	1	1000154	4014486461763
5		544164.0	1	1001969	4014486490800

## DOMINATOR 370 MEGA TYP 846

0	N = 519 MIN-1	066034.0	1	1000302	4014486465037
0		506671.0	1	1000506	4014486467840
0		506671.1	1	1000506	4014486467840
0		506671.2	1	1000506	4014486467840
0	1 SET = 2 BELTS	544049.1	2	1001561	4014486484618
0		544166.0	1	1003360	4014486484830
0		544172.0	1	1001745	4014486487299
0	TO NO. 84500261	545668.1	1	1000119	4014486461305
0	TO NO. 84500261	545668.2	1	1004356	4014486714005
0	TO NO. 84500261	545689.0	1	1003332	4014486461886
0	ALTERNATOR FROM NR. 84500261	545954.0	1	1002646	4014486480849
0		603337.0	1	1000662	4014486470260
0		603380.1	1	1001080	4014486498240
0		609762.0	1	1001713	4014486486919
0	TO NO. 84500386 HIGH - LOW SPEED RANGE TRANSMISSION	609823.0	1	1001225	4014486497809
0		621903.1	1	1002041	4014486475166
0		623427.1	1	1000409	4014486466720
0	WHEN THRESHING	629002.1	1	1003395	4014486462715
0		644141.1	1	1000476	4014486467475
0		644368.0	2	1000858	4014486472929
0		644368.1	2	1000858	4014486472929
0		644447.0	1	1000420	4014486466836
0		644537.0	1	1000140	4014486461572
0		644538.0	1	1001655	4014486486094
0		656028.0	1	1003335	4014486462869
0	DRUM VARIABLE SPEED DRIVE N = 650 - 1500	661220.1	1	1003340	4014486488807
0	FROM NO. 84500387	661427.0	1	1001228	4014486497847
0	WHEN THRESHING	667238.0	1	1000693	4014486470741
0		755070.0	2	1002795	4014486463279
0		755070.1	2	1002795	4014486463279



## CLAAS

0		755070.2	2	1002795	4014486463279
0		785341.0	1	1000295	4014486464870
0	ALTERNATOR FROM NO. 84500262	796998.0	1	1003945	4014486481969
0	FROM NO. 84500262	821734.2	1	1000154	4014486461763
5		544164.0	1	1001969	4014486490800

### DOMINATOR 370 MEGA TYP C12

0	N = 519 MIN-1	066034.0	1	1000302	4014486465037
0		506671.0	1	1000506	4014486467840
0		506671.1	1	1000506	4014486467840
0		506671.2	1	1000506	4014486467840
0	1 SET = 2 BELTS	544049.1	2	1001561	4014486484618
0		544166.0	1	1003360	4014486484830
0		544172.0	1	1001745	4014486487299
0	TO NO. 84500261	545668.1	1	1000119	4014486461305
0	TO NO. 84500261	545668.2	1	1004356	4014486714005
0	TO NO. 84500261	545689.0	1	1003332	4014486461886
0	ALTERNATOR TILL NR. 84500261	545954.0	1	1002646	4014486480849
0		603337.0	1	1000662	4014486470260
0		603380.1	1	1001080	4014486498240
0		609762.0	1	1001713	4014486486919
0	TO NO. 84500386 HIGH - LOW SPEED RANGE TRANSMISSION	609823.0	1	1001225	4014486497809
0		621903.1	1	1002041	4014486475166
0		623427.1	1	1000409	4014486466720
0	WHEN THRESHING	629002.1	1	1003395	4014486462715
0		644141.1	1	1000476	4014486467475
0		644368.0	2	1000858	4014486472929
0		644368.1	2	1000858	4014486472929
0		644447.0	1	1000420	4014486466836
0		644537.0	1	1000140	4014486461572
0		644538.0	1	1001655	4014486486094
0		656028.0	1	1003335	4014486462869
0	DRUM VARIABLE SPEED DRIVE N = 650 - 1500	661220.1	1	1003340	4014486488807
0	FROM NO. 84500387	661427.0	1	1001228	4014486497847
0	WHEN THRESHING	667238.0	1	1000693	4014486470741
0		755070.0	2	1002795	4014486463279
0		755070.1	2	1002795	4014486463279
0		755070.2	2	1002795	4014486463279
0	N = 660 MIN-1	785341.0	1	1000295	4014486464870
0	ALTERNATOR FROM NO. 84500262	796998.0	1	1003945	4014486481969
0	FROM NO. 84500262	821734.2	1	1000154	4014486461763
5		544164.0	1	1001969	4014486490800

### DOMINATOR 370 TYP 845

0	N = 519 MIN-1	066034.0	1	1000302	4014486465037
0	ALTERNATOR FROM NR. 84500261	545954.0	1	1002646	4014486480849
0	ALTERNATOR FROM NO. 84500262	796998.0	1	1003945	4014486481969
1	1 SET = 2 BELTS	544049.1	2	1001561	4014486484618
2	WHEN THRESHING	629002.0	1	1003395	4014486462715
2	WHEN THRESHING	629002.1	1	1003395	4014486462715
2		656028.0	1	1003335	4014486462869
3		621903.0	1	1002041	4014486475166
3		621903.1	1	1002041	4014486475166
4		544166.0	1	1003360	4014486484830
5		544164.0	1	1001969	4014486490800



## CLAAS

6		603337.0	1	1000662	4014486470260
6	WHEN THRESHING	667238.0	1	1000693	4014486470741
7		644141.1	1	1000476	4014486467475
8		644447.0	1	1000420	4014486466836
9		623427.1	1	1000409	4014486466720
10		755070.1	2	1002795	4014486463279
11	N = 660 MIN-1	785341.0	1	1000295	4014486464870
12		644368.0	2	1000858	4014486472929
13		544172.0	1	1001745	4014486487299
14		603380.1	1	1001080	4014486498240
15		609762.0	1	1001713	4014486486919
17		644538.0	1	1001655	4014486486094
19		506671.2	1	1000506	4014486467840
20	TO NO. 84500261	545689.0	1	1003332	4014486461886
20	FROM NO. 84500262	821734.2	1	1000154	4014486461763
21	TO NO. 84500261	545668.1	1	1000119	4014486461305
22		644537.0	1	1000140	4014486461572
23	TO NO. 84500386 HIGH - LOW SPEED RANGE TRANSMISSION	609823.0	1	1001225	4014486497809
23	FROM NO. 84500387	661427.0	1	1001228	4014486497847
24	DRUM VARIABLE SPEED DRIVE N = 650 - 1500	661220.0	1	1003340	4014486488807
24	DRUM VARIABLE SPEED DRIVE N = 650 - 1500	661220.1	1	1003340	4014486488807

### DOMINATOR 370 TYP 846

0	N = 519 MIN-1	066034.0	1	1000302	4014486465037
0	ALTERNATOR FROM NR. 84500261	545954.0	1	1002646	4014486480849
0	ALTERNATOR FROM NO. 84500262	796998.0	1	1003945	4014486481969
1	1 SET = 2 BELTS	544049.1	2	1001561	4014486484618
2	WHEN THRESHING	629002.0	1	1003395	4014486462715
2	WHEN THRESHING	629002.1	1	1003395	4014486462715
2		656028.0	1	1003335	4014486462869
3		621903.0	1	1002041	4014486475166
3		621903.1	1	1002041	4014486475166
4		544166.0	1	1003360	4014486484830
5		544164.0	1	1001969	4014486490800
6		603337.0	1	1000662	4014486470260
6	WHEN THRESHING	667238.0	1	1000693	4014486470741
7		644141.1	1	1000476	4014486467475
8		644447.0	1	1000420	4014486466836
9		623427.1	1	1000409	4014486466720
10		755070.1	2	1002795	4014486463279
11		785341.0	1	1000295	4014486464870
12		644368.0	2	1000858	4014486472929
13		544172.0	1	1001745	4014486487299
14		603380.1	1	1001080	4014486498240
15		609762.0	1	1001713	4014486486919
17		644538.0	1	1001655	4014486486094
19		506671.2	1	1000506	4014486467840
20	TO NO. 84500261	545689.0	1	1003332	4014486461886
20	FROM NO. 84500262	821734.2	1	1000154	4014486461763
21	TO NO. 84500261	545668.1	1	1000119	4014486461305
22		644537.0	1	1000140	4014486461572
23	TO NO. 84500386 HIGH - LOW SPEED RANGE TRANSMISSION	609823.0	1	1001225	4014486497809
23	FROM NO. 84500387	661427.0	1	1001228	4014486497847
24	DRUM VARIABLE SPEED DRIVE N = 650 - 1500	661220.0	1	1003340	4014486488807
24	DRUM VARIABLE SPEED DRIVE N = 650 - 1500	661220.1	1	1003340	4014486488807

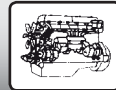

# CLAAS

## DOMINATOR 370 TYP C12

0	N = 519 MIN-1	066034.0	1	1000302	4014486465037
0	ALTERNATOR TILL NR. 84500261	545954.0	1	1002646	4014486480849
0		644538.0	1	1001655	4014486486094
0	ALTERNATOR FROM NO. 84500262	796998.0	1	1003945	4014486481969
1	1 SET = 2 BELTS	544049.1	2	1001561	4014486484618
2	WHEN THRESHING	629002.0	1	1003395	4014486462715
2	WHEN THRESHING	629002.1	1	1003395	4014486462715
2		656028.0	1	1003335	4014486462869
3		621903.0	1	1002041	4014486475166
3		621903.1	1	1002041	4014486475166
4		544166.0	1	1003360	4014486484830
5		544164.0	1	1001969	4014486490800
6		603337.0	1	1000662	4014486470260
6	WHEN THRESHING	667238.0	1	1000693	4014486470741
7		644141.1	1	1000476	4014486467475
8		644447.0	1	1000420	4014486466836
9		623427.1	1	1000409	4014486466720
10		755070.1	2	1002795	4014486463279
11	N = 660 MIN-1	785341.0	1	1000295	4014486464870
12		644368.0	2	1000858	4014486472929
13		544172.0	1	1001745	4014486487299
14		603380.1	1	1001080	4014486498240
15		609762.0	1	1001713	4014486486919
19		506671.2	1	1000506	4014486467840
20	TO NO. 84500261	545689.0	1	1003332	4014486461886
20	FROM NO. 84500262	821734.2	1	1000154	4014486461763
21	TO NO. 84500261	545668.1	1	1000119	4014486461305
22		644537.0	1	1000140	4014486461572
23	TO NO. 84500386 HIGH - LOW SPEED RANGE TRANSMISSION	609823.0	1	1001225	4014486497809
23	FROM NO. 84500387	661427.0	1	1001228	4014486497847
24	DRUM VARIABLE SPEED DRIVE N = 650 - 1500	661220.0	1	1003340	4014486488807
24	DRUM VARIABLE SPEED DRIVE N = 650 - 1500	661220.1	1	1003340	4014486488807

## DOMINATOR 38

3	TO NO. 15200469	785341.0	1	1000295	4014486464870
6	FROM CUTTERBAR 247185	670224.1	1	1001158	4014486497380
8	FANNING MILL	724141.0	1	1000709	4014486470970
9	FOR THRESHING MECHANISM	724101.0	1	1001682	4014486486537
10		724179.0	1	1003423	4014486463965
11	HYDRAULIC PUMP	767057.1	1	1003333	4014486462609
12	FOR GROUND DRIVE	724180.0	1	1003615	4014486486490
13	STRAW WALKER	785176.0	1	1000389	4014486466522
16	FROM CUTTERBAR 247185	724301.0	1	1000648	4014486470093
16	FROM CUTTERBAR 247185	724301.1	1	1000648	4014486470093
17	TO NO. 15200689	724168.0	1	1000624	4014486520262
17	FROM NO. 15200690	724339.0	1	1000630	4014486469813
18	TO NO. 15201319	629756.0	1	1001209	4014486497687
18	FROM NO. 15201320	671083.0	1	1003588	4014486460292
19		724248.1	1	1000850	4014486472806
20		603380.1	1	1001080	4014486498240
21		061878.0	1	1000824	4014486472509
25	STRAW CHOPPER	061872.0	2	1002867	4014486471939
26		603247.1	1	1003626	4014486488111

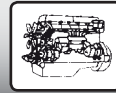
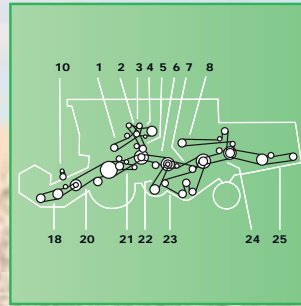
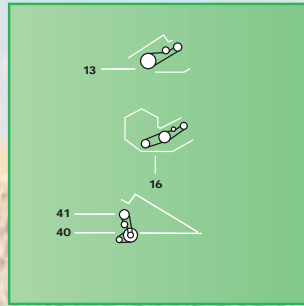
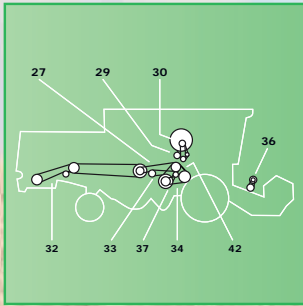

# CLAAS

## DOMINATOR 48

0	GRAIN TANK UNLOADING	673614.1	1	1001566	4014486484694
0	HYDRAULIC PUMP DRIVE	767057.1	1	1003333	4014486462609
3	REEL DRIVE	778561.0	1	1001038	4014486496376
5		724301.0	1	1000648	4014486470093
5		724301.1	1	1000648	4014486470093
8	REEL DRIVE	670224.0	1	1001158	4014486497380
9	FANNING MILL	724141.0	1	1000709	4014486470970
10	FOR THRESHING MECHANISM	724101.0	1	1001682	4014486486537
11	GRAIN TANK UNLOADING	673614.0	1	1001566	4014486484694
12	HYDRAULIC PUMP DRIVE	767057.0	1	1003333	4014486462609
13		724180.0	1	1003615	4014486486490
14	STRAW WALKER DRIVE	785176.0	1	1000389	4014486466522
16		724168.0	1	1000624	4014486520262
17	TRACTION DRIVE	629756.0	1	1001209	4014486497687
18		724248.0	1	1000848	4014486472776
19	CLEANING FAN	603380.0	1	1001080	4014486498240
24	THRESHING MACHINE	061872.0	2	1002867	4014486471939
25	THRESHING MACHINE	603015.0	1	1001503	4014486460186
25	THRESHING MACHINE	603247.0	1	1003626	4014486488111
	THRESHING MACHINE	603015.1	1	1001503	4014486460186
	THRESHING MACHINE	603247.1	1	1003626	4014486488111
	CLEANING FAN	603380.1	1	1001080	4014486498240
	REEL DRIVE	670224.1	1	1001158	4014486497380
		724248.1	1	1000850	4014486472806

## DOMINATOR 48 SP

3	REEL DRIVE	778561.0	1	1001038	4014486496376
5		724301.0	1	1000648	4014486470093
5		724301.1	1	1000648	4014486470093
8	REEL DRIVE	670224.1	1	1001158	4014486497380
9	FANNING MILL	724141.0	1	1000709	4014486470970
10	FOR THRESHING MECHANISM	724100.0	1	1001907	4014486489699
11	GRAIN TANK UNLOADING	673614.1	1	1001566	4014486484694
12	HYDRAULIC PUMP DRIVE	767057.1	1	1003333	4014486462609
13		783268.1	1	1002055	4014486475326
14	STRAW WALKER DRIVE	724180.0	1	1003615	4014486486490
15		785176.0	1	1000389	4014486466522
16		802931.0	1	1003456	4014486465945
18		724168.0	1	1000624	4014486520262
18		724339.0	1	1000630	4014486469813
19	CLEANING FAN	629756.0	1	1001209	4014486497687
20		724247.0	1	1000849	4014486472783
20		724247.1	1	1000849	4014486472783
21		603380.1	1	1001080	4014486498240
22		061902.0	1	1000851	4014486472813
26	STRAW CHOPPER	061872.0	2	1002867	4014486471939
27	AT N 650 - 1500 MIN-1 TO NO 15400931	603015.1	1	1001503	4014486460186
27	AT N 650 - 1500 MIN-1 FROM NO. 15400932	661429.0	1	1001212	4014486497717
27	AT N 500 - 1400 MIN-1	661430.0	1	1001229	4014486497830
28	PERKINS 4.236 / 4.248	147227.0	1	1003722	4014486494990
28	PERKINS 6.3544	147228.1	1	1002283	4014486479669
28	PERKINS 1006.6	147233.1	2	1002945	4014486495492

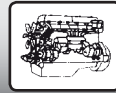
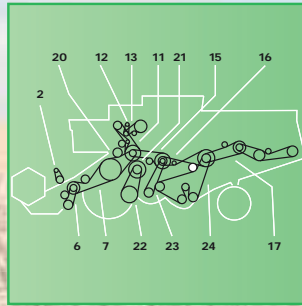
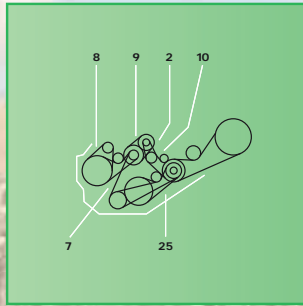
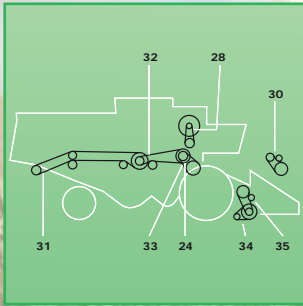

# CLAAS

## DOMINATOR 56

0	WHEEL SHAFT (FRONT)	060306.3	1	No AP	
0	WHEEL SHAFT (FRONT)	060306.4	1	1000723	4014486471151
0	DISCHARGE AUGER SHAFT	673614.1	1	1001566	4014486484694
2	REEL DRIVE VARIABLE SPEED	670224.0	1	1001158	4014486497380
6	KNIFE DRIVE	629214.0	1	1002317	4014486480054
7	CUTTING TABLE	603122.0	1	1001116	4014486497007
7	CUTTING TABLE	629081.0	1	1000754	4014486471533
7	CUTTING TABLE	629081.1	1	1000754	4014486471533
8	REEL DRIVE	603284.0	1	1000507	4014486467857
9	CUTTING MECH	056961.0	1	1000117	4014486461268
11	HYDRAULIC PUMP DRIVE	767057.1	1	1003333	4014486462609
12	AIR CONDITIONING	621903.0	1	1002041	4014486475166
12	AIR CONDITIONING	621903.1	1	1002041	4014486475166
13	DISCHARGE AUGER SHAFT	673614.0	1	1001566	4014486484694
14	TRACTION DRIVE	671012.0	1	1003631	4014486488500
15	THRESHING MACHINE	603337.0	1	1000662	4014486470260
15	THRESHING MACHINE	672358.0	1	1000662	4014486470260
16	SHAKER SHOE DRIVE	603336.0	1	1000478	4014486467499
16	SHAKER SHOE DRIVE	603336.1	1	1000478	4014486467499
17	STRAW WALKER	506671.0	1	1000506	4014486467840
17	STRAW WALKER	506671.1	1	1000506	4014486467840
17	STRAW WALKER	506671.2	1	1000506	4014486467840
18	CUTTING TABLE	603283.0	1	1000669	4014486470376
19	KNIFE DRIVE	603048.0	1	1000503	4014486467789
20	THRESHING MACHINE	673638.1	1	1001099	4014486496819
21	TRACTION DRIVE	629436.0	1	1001630	4014486485738
22	TRACTION DRIVE	629737.0	1	1001511	4014486460285
23	BLOWER	671209.0	1	1001039	4014486496383
24	SHAKER SHOE DRIVE	603017.0	2	1000833	4014486472592
24	SHAKER SHOE DRIVE	603017.3	2	1000833	4014486472592
25	STRAW DISTRIBUTOR	635494.0	2	1000382	4014486466454
25	STRAW DISTRIBUTOR	635494.1	2	1000382	4014486466454
28	COOLER	783430.0	1	1000238	4014486463422
28	COOLER	783430.1	1	1000238	4014486463422
30	THRESHING MACHINE	603247.0	1	1003626	4014486488111
30	THRESHING MACHINE	603247.1	1	1003626	4014486488111
31	STRAW CHOPPER DRIVE	061361.0	1	1000861	4014486472967
32	WHEEL SHAFT (FRONT)	060306.2	1	1000723	4014486471151
33	CYLINDER DRIVE	603015.1	1	1001503	4014486460186
34	FOR MAIZE PICKER	629410.0	2	1002872	4014486468441
35	FOR MAIZE PICKER	680334.0	1	1001819	4014486488364
35	FOR MAIZE PICKER	680334.1	1	1001819	4014486488364
	SHAKER SHOE DRIVE	603017.2	2	1000833	4014486472592
	KNIFE DRIVE	629214.1	1	1002317	4014486480054
		629410.1	2	1002872	4014486468441
	REEL DRIVE VARIABLE SPEED	670224.1	1	1001158	4014486497380
	TRACTION DRIVE	671012.1	1	1003631	4014486488500

## DOMINATOR 58

0		061872.0	2	1002867	4014486471939
0		061902.0	1	1000851	4014486472813
0		603015.0	1	1001503	4014486460186
0		603380.0	1	1001080	4014486498240

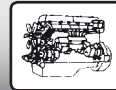
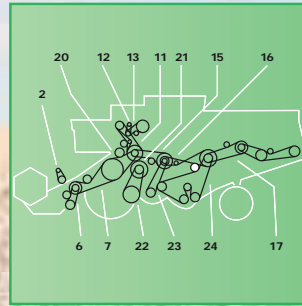
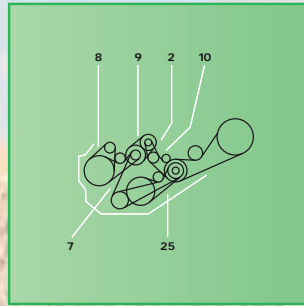
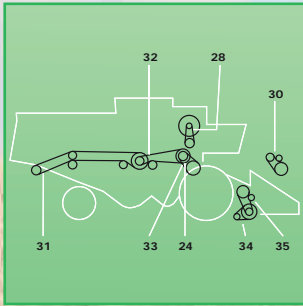

## CLAAS

0		629756.0	1	1001209	4014486497687
0		644177.0	1	1001221	4014486497762
0		673614.0	1	1001566	4014486484694
0		673614.1	1	1001566	4014486484694
0		724100.0	1	1001907	4014486489699
0		724141.0	1	1000709	4014486470970
0		724181.0	1	1001679	4014486486483
0		724247.0	1	1000849	4014486472783
0		724247.1	1	1000849	4014486472783
0		724301.0	1	1000648	4014486470093
0		724301.1	1	1000648	4014486470093
0		767057.0	1	1003333	4014486462609
0		767057.1	1	1003333	4014486462609
0		778561.0	1	1001038	4014486496376
0		785176.0	1	1000389	4014486466522
0		802931.0	1	1003456	4014486465945
		603015.1	1	1001503	4014486460186
		603380.1	1	1001080	4014486498240

### DOMINATOR 58 SP

3	TO CUTTERBAR 247184	778561.0	1	1001038	4014486496376
5		724301.0	1	1000648	4014486470093
5		724301.1	1	1000648	4014486470093
8	FROM CUTTERBAR 247185	670224.1	1	1001158	4014486497380
9	FANNING MILL	724141.0	1	1000709	4014486470970
10	FOR THRESHING MECHANISM	724100.0	1	1001907	4014486489699
11		673614.1	1	1001566	4014486484694
12	HYDRAULIC PUMP	767057.1	1	1003333	4014486462609
13	FROM CUTTERBAR 247185	783268.1	1	1002055	4014486475326
14	FROM NO. 15400642	724180.0	1	1003615	4014486486490
15	TO NO. 15400641	785176.0	1	1000389	4014486466522
16		802931.0	1	1003456	4014486465945
18		724168.0	1	1000624	4014486520262
18		724339.0	1	1000630	4014486469813
19		629756.0	1	1001209	4014486497687
20		724247.0	1	1000849	4014486472783
20		724247.1	1	1000849	4014486472783
21		603380.1	1	1001080	4014486498240
22		061902.0	1	1000851	4014486472813
26	STRAW CHOPPER	061872.0	2	1002867	4014486471939
27	AT N 650 - 1500 MIN-1 TO NO 15400931	603015.1	1	1001503	4014486460186
27	AT N 650 - 1500 MIN-1 FROM NO. 15400932	661429.0	1	1001212	4014486497717
27	AT N 500 - 1400 MIN-1	661430.0	1	1001229	4014486497830
28	PERKINS 4.236 / 4.248	147227.0	1	1003722	4014486494990
28	PERKINS 6.3544	147228.1	1	1002283	4014486479669
28	PERKINS 1006.6	147233.1	2	1002945	4014486495492

### DOMINATOR 66

0	WHEEL SHAFT (FRONT)	060306.3	1	No AP	
0	WHEEL SHAFT (FRONT)	060306.4	1	1000723	4014486471151
0		603017.0	2	1000833	4014486472592
0	DISCHARGE AUGER SHAFT	673614.1	1	1001566	4014486484694
2	REEL DRIVE VARIABLE SPEED	670224.0	1	1001158	4014486497380
6	KNIFE DRIVE	629214.0	1	1002317	4014486480054
7		603122.0	1	1001116	4014486497007



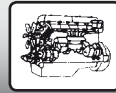
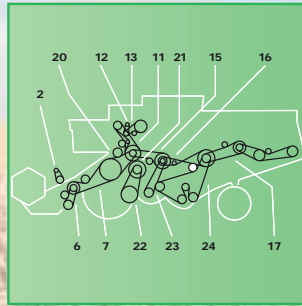
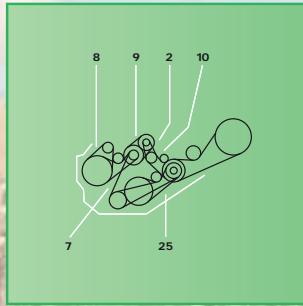
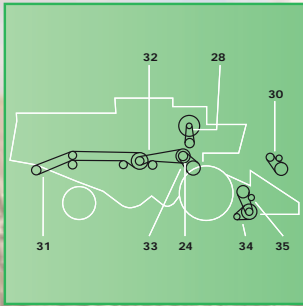

# CLAAS

7		629081.0	1	1000754	4014486471533
7		629081.1	1	1000754	4014486471533
8		603284.0	1	1000507	4014486467857
11	HYDRAULIC PUMP DRIVE	767057.1	1	1003333	4014486462609
12		621903.0	1	1002041	4014486475166
12		621903.1	1	1002041	4014486475166
13	DISCHARGE AUGER SHAFT	673614.0	1	1001566	4014486484694
14	TRACTION DRIVE	671012.0	1	1003631	4014486488500
15		603337.0	1	1000662	4014486470260
15		672358.0	1	1000662	4014486470260
16		603336.0	1	1000478	4014486467499
16		603336.1	1	1000478	4014486467499
17		506671.0	1	1000506	4014486467840
17		506671.1	1	1000506	4014486467840
17		506671.2	1	1000506	4014486467840
18		603283.0	1	1000669	4014486470376
19		603048.0	1	1000503	4014486467789
20		673638.1	1	1001099	4014486496819
21		629436.0	1	1001630	4014486485738
22		629737.0	1	1001511	4014486460285
23		671209.0	1	1001039	4014486496383
24		603017.3	2	1000833	4014486472592
25		635494.0	2	1000382	4014486466454
25		635494.1	2	1000382	4014486466454
28		783430.0	1	1000238	4014486463422
28		783430.1	1	1000238	4014486463422
30		603247.0	1	1003626	4014486488111
31		061361.0	1	1000861	4014486472967
32	WHEEL SHAFT (FRONT)	060306.2	1	1000723	4014486471151
33		603015.1	1	1001503	4014486460186
34		629410.0	2	1002872	4014486468441
35		680334.0	1	1001819	4014486488364
35		680334.1	1	1001819	4014486488364
		603017.2	2	1000833	4014486472592
		603247.1	1	1003626	4014486488111
	KNIFE DRIVE	629214.1	1	1002317	4014486480054
		629410.1	2	1002872	4014486468441
	REEL DRIVE VARIABLE SPEED	670224.1	1	1001158	4014486497380
	TRACTION DRIVE	671012.1	1	1003631	4014486488500

## DOMINATOR 68

0		673614.1	1	1001566	4014486484694
0	CUTTING MECHANICAL BY 3.6 M TO 5.1 M TO 25580	713506.0	1	1000315	4014486465310
0	FOR 3.6 M · 5.1 M TO CUTTING MECHANICAL 255807	713506.0	1	1000315	4014486465310
1	REEL DRIVE	603284.0	1	1000507	4014486467857
3	REEL DRIVE	670224.1	1	1001158	4014486497380
5	CUTTING MECHANICAL BY 3.0 M TO CUT 255806	603283.0	1	1000669	4014486470376
5	CUTTING MECHANICAL BY 3.6 M TO 5.1 M TO 255807	713506.0	1	1000315	4014486465310
5	CUTTING MECHANICAL BY 3.6 M TO 5.1 M TO 255807	713506.1	1	1000315	4014486465310
5	CUTTING MECHANICAL BY 3.6 M TO 5.1 M TO 255807	713506.2	1	1000315	4014486465310
5	TO CUTTING MECHANICAL BY 3.0 TO CUT. 255807	778717.1	2	1004307	4014486714937
6	CUTTING MECHANICAL BY 3.0 M	603048.0	1	1000503	4014486467789
7	2X BY MAIZE PICKET (TO NR. 15606083)	603290.0		1000764	4014486471670
7	2X BY MAIZE PICKET (TO NR. 15606082)	629836.0	1	1000746	4014486471427
11	THRESHING MACHINE	724100.0	1	1001907	4014486489699



## CLAAS

12	SHAKER SHOE DRIVE	724141.0	1	1000709	4014486470970
13	UNLOADER DRIVE	673614.0	1	1001566	4014486484694
14	HYDRAULIC PUMP DRIVE	767057.1	1	1003333	4014486462609
15	TRACTION DRIVE	724181.0	1	1001679	4014486486483
16	STRAW WALKER DRIVE	785176.0	1	1000389	4014486466522
17	AIR INTAKE	802931.0	1	1003456	4014486465945
18	STRAW DISTRIBUTOR	509435.0	1	1000403	4014486466669
20	CUTTING MECHANICAL TO 3.6 M	629214.1	1	1002317	4014486480054
21	THRESHING MACHINE	673638.1	1	1001099	4014486496819
22	TRACTION DRIVE	629756.0	1	1001209	4014486497687
23	FAN INTERMEDIATE DRIVE	603380.1	1	1001080	4014486498240
24	SHAKER SHOE DRIVE	724247.0	1	1000849	4014486472783
24	SHAKER SHOE DRIVE	724247.1	1	1000849	4014486472783
27	STRAW CHOPPER DRIVE FOR GRAIN	061902.0	1	1000851	4014486472813
27	CHOPPER FOR MAIZE	062043.0	1	1000843	4014486472721
28	THRESHING MACHINE	061872.0	2	1002867	4014486471939
30	CYLINDER DRIVE FOR N=650-1550 RPM (TO NR. 15603256)	603015.1	1	1001503	4014486460186
30	CYLINDER DRIVE FOR N=650-1500 RPM (TO NR. 15603257)	628630.0	1	1001208	4014486497670
30	CYLINDER DRIVE FOR N=500-1400 RPM	644177.0	1	1001221	4014486497762
31	CHOPPER DRIVE	629410.0	2	1002872	4014486468441
32	MAIZE PICKER	680334.0	1	1001819	4014486488364
32	MAIZE PICKER	680334.1	1	1001819	4014486488364
33	AIR CONDITIONING COMPRESSOR DRIVE	783268.1	1	1002055	4014486475326
	CUTTING MECHANICAL BY 3.0 M	056961.0	1	1000117	4014486461268
		629410.1	2	1002872	4014486468441
	2X BY MAIZE PICKET (TO NR. 15606082)	629836.1	2	1003819	4014486518870

## DOMINATOR 68 R

0	GRAIN TANK UNLOADING	673614.1	1	1001566	4014486484694
3	REEL VARIATOR	670224.1	1	1001158	4014486497380
5	KNIFE DRIVE	713506.0	1	1000315	4014486465310
5	KNIFE DRIVE	713506.1	1	1000315	4014486465310
5	KNIFE DRIVE	713506.2	1	1000315	4014486465310
7	FROM NO. 15500594 (2X FOR CORN)	603290.0		1000764	4014486471670
7	FEEDER DRIVE TO NO. 15500593 (2X FORN CORN)	629836.0	1	1000746	4014486471427
7	FEEDER DRIVE TO NO. 15500593 (2X FORN CORN)	629836.1	2	1003819	4014486518870
11		724100.0	1	1001907	4014486489699
12	FANNING MILL	724141.0	1	1000709	4014486470970
13	GRAIN TANK UNLOADING	673614.0	1	1001566	4014486484694
14	HYDRAULIC PUMP	767057.1	1	1003333	4014486462609
15	GROUND DRIVE	724181.0	1	1001679	4014486486483
16		785176.0	1	1000389	4014486466522
17	FEED RAKE DRIVE	802931.0	1	1003456	4014486465945
18	STRAW SPREADER	509435.0	1	1000403	4014486466669
21	CUTTERBAR DRIVE	673638.1	1	1001099	4014486496819
22	DRIVE - VARIATOR	629756.0	1	1001209	4014486497687
23	BLOWER - VARIATOR	603380.1	1	1001080	4014486498240
24	SIEVE PAN DRIVE	724247.0	1	1000849	4014486472783
24	SIEVE PAN DRIVE	724247.1	1	1000849	4014486472783
27	AT GRAIN	061902.0	1	1000851	4014486472813
27	AT CORN	062043.0	1	1000843	4014486472721
28	FEEDER HOUSING LONG	061872.0	2	1002867	4014486471939
28	STRAW CHOPPER	061872.0	2	1002867	4014486471939
30	AT N 650 - 1550 MIN-1	603015.1	1	1001503	4014486460186
30	AT N 650 - 1500 MIN-1	628630.0	1	1001208	4014486497670

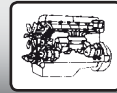
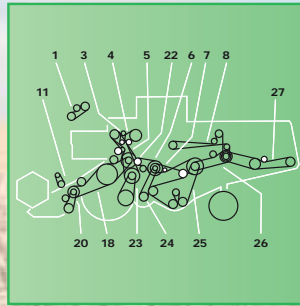
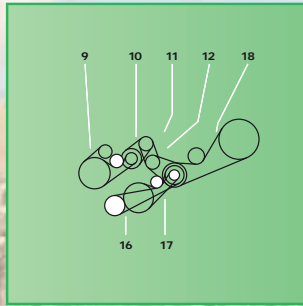
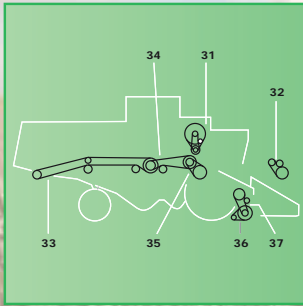

## CLAAS

30	AT N 500 - 1400 MIN-1	644177.0	1	1001221	4014486497762
31	FOR HPH - CHOPPER	629410.0	2	1002872	4014486468441
32	FOR HPH - CHOPPER	680334.0	1	1001819	4014486488364
32	FOR HPH - CHOPPER	680334.1	1	1001819	4014486488364
33	AIR CONDITIONER	783268.1	1	1002055	4014486475326
	FOR HPH - CHOPPER	629410.1	2	1002872	4014486468441
0	MERCEDES OM 352	133523.0	1	1002551	4014486494846
0	PERKINS 6.3544	147228.1	1	1002283	4014486479669
0	PERKINS 1006.6	147233.1	2	1002945	4014486495492

### DOMINATOR 68 SR

0	GRAIN TANK UNLOADING	673614.1	1	1001566	4014486484694
3	REEL VARIATOR	670224.1	1	1001158	4014486497380
5	KNIFE DRIVE	713506.0	1	1000315	4014486465310
5	KNIFE DRIVE	713506.1	1	1000315	4014486465310
5	KNIFE DRIVE	713506.2	1	1000315	4014486465310
7	FROM NO. 15500594 (2X FOR CORN)	603290.0		1000764	4014486471670
7	FEEDER DRIVE TO NO. 15500593 (2X FORN CORN)	629836.0	1	1000746	4014486471427
7	FEEDER DRIVE TO NO. 15500593 (2X FORN CORN)	629836.1	2	1003819	4014486518870
11		724100.0	1	1001907	4014486489699
12	FANNING MILL	724141.0	1	1000709	4014486470970
13	GRAIN TANK UNLOADING	673614.0	1	1001566	4014486484694
14	HYDRAULIC PUMP	767057.1	1	1003333	4014486462609
15	GROUND DRIVE	724181.0	1	1001679	4014486486483
16		785176.0	1	1000389	4014486466522
17	FEED RAKE DRIVE	802931.0	1	1003456	4014486465945
18	STRAW SPREADER	509435.0	1	1000403	4014486466669
21	CUTTERBAR DRIVE	673638.1	1	1001099	4014486496819
22	DRIVE - VARIATOR	629756.0	1	1001209	4014486497687
23	BLOWER - VARIATOR	603380.1	1	1001080	4014486498240
24	SIEVE PAN DRIVE	724247.0	1	1000849	4014486472783
24	SIEVE PAN DRIVE	724247.1	1	1000849	4014486472783
27	AT GRAIN	061902.0	1	1000851	4014486472813
27	AT CORN	062043.0	1	1000843	4014486472721
28	FEEDER HOUSING LONG	061872.0	2	1002867	4014486471939
28	STRAW CHOPPER	061872.0	2	1002867	4014486471939
30	AT N 650 - 1550 MIN-1	603015.1	1	1001503	4014486460186
30	AT N 650 - 1500 MIN-1	628630.0	1	1001208	4014486497670
30	AT N 500 - 1400 MIN-1	644177.0	1	1001221	4014486497762
31	FOR HPH - CHOPPER	629410.0	2	1002872	4014486468441
32	FOR HPH - CHOPPER	680334.0	1	1001819	4014486488364
32	FOR HPH - CHOPPER	680334.1	1	1001819	4014486488364
33	AIR CONDITIONER	783268.1	1	1002055	4014486475326
	FOR HPH - CHOPPER	629410.1	2	1002872	4014486468441
0	MERCEDES OM 352	133523.0	1	1002551	4014486494846
0	PERKINS 6.3544	147228.1	1	1002283	4014486479669
0	PERKINS 1006.6	147233.1	2	1002945	4014486495492

### DOMINATOR 76

0		056961.0	1	1000117	4014486461268
0		060306.3	1	No AP	
0		060306.4	1	1000723	4014486471151
0		603017.0	2	1000833	4014486472592
0	KNIFE DRIVE	629214.0	1	1002317	4014486480054
0	ELEVATOR DRIVE UNIT	629732.0	1	1000415	4014486466782



## CLAAS

0	DISCHARGE AUGER SHAFT	673614.1	1	1001566	4014486484694
1		673625.0	1	1001793	4014486488005
2	HYDRAULIC PUMP DRIVE	767057.1	1	1003333	4014486462609
3	AT AIR CONDITIONING	621903.0	1	1002041	4014486475166
3	AT AIR CONDITIONING	621903.1	1	1002041	4014486475166
3	AT AIR CONDITIONING	629908.0	1	1002332	4014486478631
3	AT AIR CONDITIONING	629908.1	1	1002332	4014486478631
4	DISCHARGE AUGER SHAFT	673614.0	1	1001566	4014486484694
5	TRACTION DRIVE	671012.0	1	1003631	4014486488500
5	TRACTION DRIVE	671012.1	1	1003631	4014486488500
6	FAN DRIVE	603337.0	1	1000662	4014486470260
6	FAN DRIVE	672358.0	1	1000662	4014486470260
7	SIEVE DRIVE	603336.0	1	1000478	4014486467499
7	SIEVE DRIVE	603336.1	1	1000478	4014486467499
8	STRAW WALKER DRIVE	629732.1	1	1000416	4014486466799
8		629732.2	1	1000417	4014486520507
9	REEL DRIVE	603284.0	1	1000507	4014486467857
11	REEL DRIVE VARIABLE SPEED	670224.0	1	1001158	4014486497380
11	FOR CUTTERBAR	670224.1	1	1001158	4014486497380
13	FOR CORN PICKER	692149.0	1	1001852	4014486488869
13	FOR CORN PICKER	692150.0	1	1001857	4014486488920
16	CUTTING TABLE	603283.0	1	1000669	4014486470376
16	FROM 3.6 M CUTTERBAR	713506.0	1	1000315	4014486465310
16	FROM 3.6 M CUTTERBAR	713506.1	1	1000315	4014486465310
16	FROM 3.6 M CUTTERBAR	713506.2	1	1000315	4014486465310
16	AT 3.0 M CUTTERBAR	778717.1	2	1004307	4014486714937
17	HEADER DRIVE	603048.0	1	1000503	4014486467789
18	FEEDER DRIVE FROM NO. 09101947 FOR CORN	603122.0	1	1001116	4014486497007
18	FROM NO. 09101947 FOR CORN	603290.0		1000764	4014486471670
18	FEEDER DRIVE TO NO. 09101946 FOR CORN	629836.0	1	1000746	4014486471427
20	AT MECHANICAL GROUND DRIVE	603427.0	1	1001627	4014486485660
21	AT MECHANICAL GROUND DRIVE	603317.0	1	1001515	4014486460346
21	THRESHING MACHINE	673638.1	1	1001099	4014486496819
22	TRACTION DRIVE	629436.0	1	1001630	4014486485738
22	TRACTION DRIVE	671209.0	1	1001039	4014486496383
23	RETURNS AUGER	603017.3	2	1000833	4014486472592
23	RETURNS AUGER	629737.0	1	1001511	4014486460285
25	SHAKER SHOE DRIVE	603017.3	2	1000833	4014486472592
26	STRAW WALKER DRIVE	506671.0	1	1000506	4014486467840
26	STRAW WALKER DRIVE	506671.1	1	1000506	4014486467840
26	STRAW WALKER DRIVE	506671.2	1	1000506	4014486467840
27	STRAW DISTRIBUTOR	623427.1	1	1000409	4014486466720
31	FOR GRAIN - CHOPPER	061360.1	1	1000870	4014486473094
31	COOLER	783430.0	1	1000238	4014486463422
31	COOLER	783430.1	1	1000238	4014486463422
32	TRESHING MACHINE	603247.0	1	1003626	4014486488111
33	STRAW CHOPPER DRIVE	061360.1	1	1000870	4014486473094
34	TRESHING MACHINE	060306.2	1	1000723	4014486471151
34	FOR HPG - G CHOPPER	680334.0	1	1001819	4014486488364
34	FOR HPG - G CHOPPER	680334.1	1	1001819	4014486488364
35	TRESHING MACHINE	603015.1	1	1001503	4014486460186
36	FOR MAIZE PICKER	629410.0	2	1002872	4014486468441
37	FOR MAIZE PICKER	680334.0	1	1001819	4014486488364
37	FOR MAIZE PICKER	680334.1	1	1001819	4014486488364
		603017.2	2	1000833	4014486472592

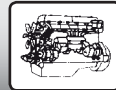

# CLAAS

		603247.1	1	1003626	4014486488111
	KNIFE DRIVE	629214.1	1	1002317	4014486480054
		629410.1	2	1002872	4014486468441

## DOMINATOR 78

0	FOR STRAW CHOPPER	060306.3	1	No AP	
0	FOR STRAW CHOPPER	060306.4	1	1000723	4014486471151
0	FOR CORN CHOPPER	061214.0	1	1000868	4014486473070
0	RETURNS AUGER	603017.0	2	1000833	4014486472592
0	ROTARY SCREEN	603341.0	1	1003328	4014486463217
0	AT N 650 - 1500 MIN-1	628630.0	1	1001208	4014486497670
0	AT N 500 - 1400 MIN-1	644177.0	1	1001221	4014486497762
0		673614.1	1	1001566	4014486484694
0	FOR HPG - G CHOPPER	695610.0	1	No AP	
1		673625.0	1	1001793	4014486488005
1	AT HYDRAULIC GROUND DRIVE	673625.0	1	1001793	4014486488005
2	HYDRAULIC PUMP DRIVE	767057.1	1	1003333	4014486462609
3	AT AIR CONDITIONING	621903.0	1	1002041	4014486475166
3	AT AIR CONDITIONING	621903.1	1	1002041	4014486475166
3	AT AIR CONDITIONING	629908.0	1	1002332	4014486478631
3	AT AIR CONDITIONING	629908.1	1	1002332	4014486478631
4	DISCHARGE AUGER SHAFT	673614.0	1	1001566	4014486484694
5	TRACTION DRIVE	671012.0	1	1003631	4014486488500
5	TRACTION DRIVE	671012.1	1	1003631	4014486488500
6	FAN DRIVE	603337.0	1	1000662	4014486470260
6	FAN DRIVE	672358.0	1	1000662	4014486470260
7	SIEVE DRIVE	603336.0	1	1000478	4014486467499
7	SIEVE DRIVE	603336.1	1	1000478	4014486467499
8	STRAW WALKER DRIVE	629732.1	1	1000416	4014486466799
8		629732.2	1	1000417	4014486520507
9	REEL DRIVE	603284.0	1	1000507	4014486467857
11	REEL DRIVE VARIABLE SPEED	670224.0	1	1001158	4014486497380
11	FOR CUTTERBAR	670224.1	1	1001158	4014486497380
13	FOR CORN PICKER	692149.0	1	1001852	4014486488869
13	FOR CORN PICKER	692150.0	1	1001857	4014486488920
16	CUTTING TABLE	603283.0	1	1000669	4014486470376
16	FROM 3.6 M CUTTERBAR	713506.0	1	1000315	4014486465310
16	FROM 3.6 M CUTTERBAR	713506.1	1	1000315	4014486465310
16	FROM 3.6 M CUTTERBAR	713506.2	1	1000315	4014486465310
16	AT 3.0 M CUTTERBAR	778717.1	2	1004307	4014486714937
17	HEADER DRIVE	603048.0	1	1000503	4014486467789
18	FEEDER DRIVE FROM NO. 09101947 FOR CORN	603122.0	1	1001116	4014486497007
18	FROM NO. 09101947 FOR CORN	603290.0		1000764	4014486471670
18	FEEDER DRIVE TO NO. 09101946 FOR CORN	629836.0	1	1000746	4014486471427
20	AT MECHANICAL GROUND DRIVE	603427.0	1	1001627	4014486485660
20	AT MECHANICAL GROUND DRIVE	629214.0	1	1002317	4014486480054
21	AT MECHANICAL GROUND DRIVE	603317.0	1	1001515	4014486460346
21	THRESHING MACHINE	673638.1	1	1001099	4014486496819
22	TRACTION DRIVE	629436.0	1	1001630	4014486485738
22	TRACTION DRIVE	671209.0	1	1001039	4014486496383
23	RETURNS AUGER	603017.3	2	1000833	4014486472592
23	RETURNS AUGER	629737.0	1	1001511	4014486460285
24	TRACTION DRIVE	671209.0	1	1001039	4014486496383
25	SHAKER SHOE DRIVE	603017.3	2	1000833	4014486472592
26	STRAW WALKER DRIVE	506671.0	1	1000506	4014486467840

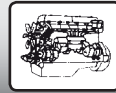
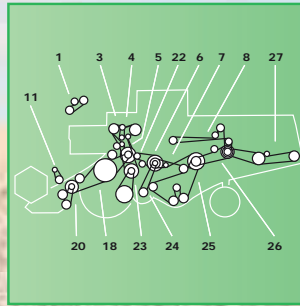
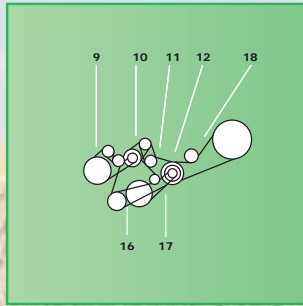
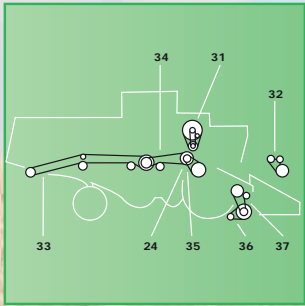

## CLAAS

26	STRAW WALKER DRIVE	506671.1	1	1000506	4014486467840
26	STRAW WALKER DRIVE	506671.2	1	1000506	4014486467840
27	FOR STRAW SPREADER	623427.1	1	1000409	4014486466720
31	FOR GRAIN - CHOPPER	061360.0	1	1000870	4014486473094
31	FOR GRAIN - CHOPPER	061360.1	1	1000870	4014486473094
31	COOLER	783430.0	1	1000238	4014486463422
31	COOLER	783430.1	1	1000238	4014486463422
32	TRESHING MACHINE	603247.0	1	1003626	4014486488111
33	STRAW CHOPPER DRIVE	061360.0	1	1000870	4014486473094
33	STRAW CHOPPER DRIVE	061360.1	1	1000870	4014486473094
34	TRESHING MACHINE	060306.2	1	1000723	4014486471151
34	FOR HPG - G CHOPPER	680334.0	1	1001819	4014486488364
34	FOR HPG - G CHOPPER	680334.1	1	1001819	4014486488364
36	FOR MAIZE PICKER	629410.0	2	1002872	4014486468441
37	FOR MAIZE PICKER	680334.0	1	1001819	4014486488364
37	FOR MAIZE PICKER	680334.1	1	1001819	4014486488364
	RETURNS AUGER	603017.2	2	1000833	4014486472592
	FEEDER DRIVE TO NO. 09101946 FOR CORN	629836.1	2	1003819	4014486518870

## DOMINATOR 80

0	COUNTERSHAFT DRIVE	060306.2	1	1000723	4014486471151
0	COUNTERSHAFT DRIVE	060306.3	1	No AP	
0	HYDRAULIC PUMP DRIVE	633030.2	1	1000220	4014486462838
0	DISCHARGE DRIVE GRAIN TANK	673614.1	1	1001566	4014486484694
0	HYDRAULIC PUMP DRIVE	767057.1	1	1003333	4014486462609
0	CUTTING TABLE DRIVE	778717.1	2	1004307	4014486714937
1	REEL DRIVE VARIABLE SPEED	670224.0	1	1001158	4014486497380
2	CUTTING TABLE DRIVE CLUTCH	560562.0	1	1001101	4014486496833
3	MAIN DRIVE	671012.0	1	1003631	4014486488500
3	MAIN DRIVE	671012.1	1	1003631	4014486488500
4	HYDRAULIC PUMP TRACTION DRIVE	673625.0	1	1001793	4014486488005
5	HYDRAULIC PUMP DRIVE	532011.0	1	1003396	4014486462784
5	HYDRAULIC PUMP DRIVE	633030.0	1	1000220	4014486462838
5	HYDRAULIC PUMP DRIVE	656028.0	1	1003335	4014486462869
5	HYDRAULIC PUMP DRIVE	767057.0	1	1003333	4014486462609
6	DISCHARGE DRIVE GRAIN TANK	673614.0	1	1001566	4014486484694
7	SHAKER SHOE FANNING MILL	672358.0	1	1000662	4014486470260
8	STRAW WALKER DRIVE	629036.0	1	1000515	4014486467949
8	STRAW WALKER DRIVE	673601.0	1	1000512	4014486467901
9	KNIFE DRIVE	629214.0	1	1002317	4014486480054
9	KNIFE DRIVE	769202.0	1	1000495	4014486467680
9	KNIFE DRIVE	769202.1	1	1000495	4014486467680
10	CUTTING TABLE DRIVE	673639.0	1	1000963	4014486474213
10	CUTTING TABLE DRIVE	778717.0	2	1004307	4014486714937
11	TRACTION DRIVE	720866.0	1	1003607	4014486485721
12	TRACTION VARIATOR DRIVE	671083.0	1	1003588	4014486460292
13	FAN MILL VARIABLE SPEED	671209.0	1	1001039	4014486496383
15	AUGER (GRAIN)	673690.0	1	1000558	4014486468557
15	AUGER (GRAIN)	673690.1	1	1000558	4014486468557
16	FEEDER AUGER	501925.0	1	1003449	4014486465501
17	COUNTERSHAFT DRIVE	060306.0	1	1000723	4014486471151
18	AIR INTAKE DRIVE	802931.0	1	1003456	4014486465945
19	STRAW CHOPPER DRIVE	060949.0	1	1000863	4014486473018
19	STRAW CHOPPER DRIVE	060949.1	1	1000863	4014486473018
20	CYLINDER VARIATOR DRIVE	629035.0	1	1001289	4014486520545

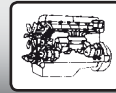
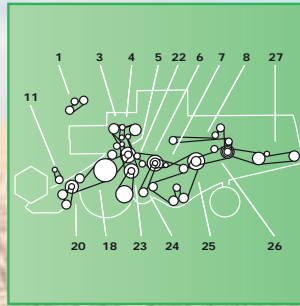
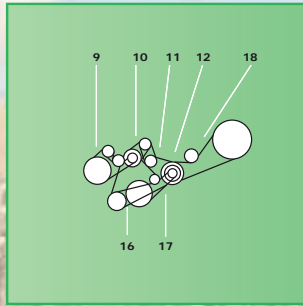
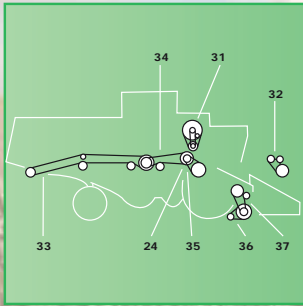

## CLAAS

20	CYLINDER VARIATOR DRIVE	671015.0	1	1001287	4014486497854
21	THRESHING MACHINE	629510.0	1	1003634	4014486488623
21	THRESHING MACHINE	629510.1	1	1003634	4014486488623
21	THRESHING MACHINE	671012.0	1	1003631	4014486488500
	HYDRAULIC PUMP DRIVE	532011.1	1	1003396	4014486462784
	KNIFE DRIVE	629214.1	1	1002317	4014486480054
	HYDRAULIC PUMP DRIVE	633030.1	1	1000220	4014486462838
	REEL DRIVE VARIABLE SPEED	670224.1	1	1001158	4014486497380
	THRESHING MACHINE	671012.1	1	1003631	4014486488500
	CUTTING TABLE DRIVE	673639.1	1	1001114	4014486496970

## DOMINATOR 85

0	COUNTERSHAFT DRIVE	060306.2	1	1000723	4014486471151
0	COUNTERSHAFT DRIVE	060306.3	1	No AP	
0	HYDRAULIC PUMP DRIVE	633030.2	1	1000220	4014486462838
0	DISCHARGE DRIVE GRAIN TANK	673614.1	1	1001566	4014486484694
0	HYDRAULIC PUMP DRIVE	767057.1	1	1003333	4014486462609
0	CUTTING TABLE DRIVE	778717.1	2	1004307	4014486714937
1	REEL DRIVE VARIABLE SPEED	670224.0	1	1001158	4014486497380
2	CUTTING TABLE DRIVE CLUTCH	560562.0	1	1001101	4014486496833
3	MAIN DRIVE	671012.0	1	1003631	4014486488500
3	MAIN DRIVE	671012.1	1	1003631	4014486488500
4	HYDRAULIC PUMP TRACTION DRIVE	673625.0	1	1001793	4014486470260
5	HYDRAULIC PUMP DRIVE	532011.0	1	1003396	4014486462784
5	HYDRAULIC PUMP DRIVE	633030.0	1	1000220	4014486462838
5	HYDRAULIC PUMP DRIVE	656028.0	1	1003335	4014486462869
5	HYDRAULIC PUMP DRIVE	767057.0	1	1003333	4014486462609
6	DISCHARGE DRIVE GRAIN TANK	673614.0	1	1001566	4014486484694
7	SHAKER SHOE FANNING MILL	672358.0	1	1000662	4014486470260
8	STRAW WALKER DRIVE	629036.0	1	1000515	4014486467949
8	STRAW WALKER DRIVE	673601.0	1	1000512	4014486467901
9	KNIFE DRIVE	629214.0	1	1002317	4014486480054
9	KNIFE DRIVE	769202.0	1	1000495	4014486467680
9	KNIFE DRIVE	769202.1	1	1000495	4014486467680
10	CUTTING TABLE DRIVE	673639.0	1	1000963	4014486474213
10	CUTTING TABLE DRIVE	778717.0	2	1004307	4014486714937
11	TRACTION DRIVE	720866.0	1	1003607	4014486485721
12	TRACTION VARIATOR DRIVE	671083.0	1	1003588	4014486460292
13	FAN MILL VARIABLE SPEED	671209.0	1	1001039	4014486496383
15	AUGER (GRAIN)	673690.0	1	1000558	4014486468557
15	AUGER (GRAIN)	673690.1	1	1000558	4014486468557
16	FEEDER AUGER	501925.0	1	1003449	4014486465501
17	COUNTERSHAFT DRIVE	060306.0	1	1000723	4014486471151
18	AIR INTAKE DRIVE	802931.0	1	1003456	4014486465945
19	STRAW CHOPPER DRIVE	060949.0	1	1000863	4014486473018
19	STRAW CHOPPER DRIVE	060949.1	1	1000863	4014486473018
20	CYLINDER VARIATOR DRIVE	629035.0	1	1001289	4014486520545
20	CYLINDER VARIATOR DRIVE	671015.0	1	1001287	4014486497854
21	THRESHING MACHINE	629510.0	1	1003634	4014486488623
21	THRESHING MACHINE	629510.1	1	1003634	4014486488623
21	THRESHING MACHINE	671012.0	1	1003631	4014486488500
	HYDRAULIC PUMP DRIVE	532011.1	1	1003396	4014486462784
	KNIFE DRIVE	629214.1	1	1002317	4014486480054
	HYDRAULIC PUMP DRIVE	633030.1	1	1000220	4014486462838
	REEL DRIVE VARIABLE SPEED	670224.1	1	1001158	4014486497380

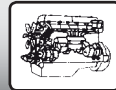
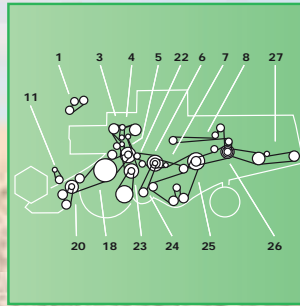
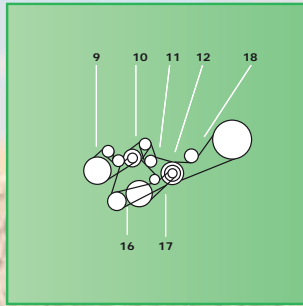
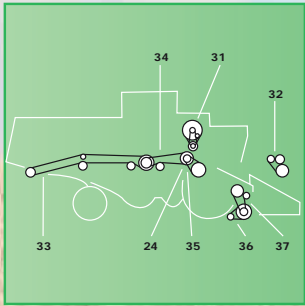

# CLAAS

	THRESHING MACHINE	671012.1	1	1003631	4014486488500
	CUTTING TABLE DRIVE	673639.1	1	1001114	4014486496970

## DOMINATOR 86

0	WHEEL SHAFT (FRONT)	060306.2	1	1000723	4014486471151
0	WHEEL SHAFT (FRONT)	060306.3	1	No AP	
0		603017.3	2	1000833	4014486472592
0	ELEVATOR DRIVE UNIT	629732.2	1	1000417	4014486520507
0	DISCHARGE AUGER SHAFT	673614.1	1	1001566	4014486484694
0	HYDRAULIC PUMP DRIVE	767057.1	1	1003333	4014486462609
1	HYDRAULIC PUMP DRIVE	767057.0	1	1003333	4014486462609
2	AIR CONDITION COMPRESSOR	621903.0	1	1002041	4014486475166
2	AIR CONDITION COMPRESSOR	621903.1	1	1002041	4014486475166
3	DISCHARGE AUGER SHAFT	673614.0	1	1001566	4014486484694
4	TRACTION DRIVE	671012.0	1	1003631	4014486488500
5	FRONT WHEEL SHAFT	603337.0	1	1000662	4014486470260
6	SHAKER SHOE DRIVE	603336.0	1	1000478	4014486467499
6	SHAKER SHOE DRIVE	603336.1	1	1000478	4014486467499
7	ELEVATOR DRIVE UNIT	629732.0	1	1000415	4014486466782
10	REEL DRIVE	670224.0	1	1001158	4014486497380
13	KNIFE DRIVE	629214.0	1	1002317	4014486480054
14	CUTTING TABLE	603122.0	1	1001116	4014486497007
15	CUTTING TABLE	673638.0	1	1001099	4014486496819
16	TRACTION DRIVE	603427.0	1	1001627	4014486485660
17	TRACTION DRIVE	603317.0	1	1001515	4014486460346
18	CLEANING FAN	671209.0	1	1001039	4014486496383
19	SHAKER SHOE DRIVE	603017.0	2	1000833	4014486472592
20	STRAW WALKER DRIVE	506671.0	1	1000506	4014486467840
20	STRAW WALKER DRIVE	506671.1	1	1000506	4014486467840
20	STRAW WALKER DRIVE	506671.2	1	1000506	4014486467840
21	STRAW DISTRIBUTOR	635494.0	2	1000382	4014486466454
21	STRAW DISTRIBUTOR	635494.1	2	1000382	4014486466454
24	COOLER	603341.0	1	1003328	4014486463217
26	STRAW CHOPPER DRIVE	061361.0	1	1000861	4014486472967
27	WHEEL SHAFT (FRONT)	060306.0	1	1000723	4014486471151
28	THRESHING MACHINE	603015.0	1	1001503	4014486460186
31	THRESHING MACHINE	603247.0	1	1003626	4014486488111
		603015.1	1	1001503	4014486460186
		603017.2	2	1000833	4014486472592
		603247.1	1	1003626	4014486488111
	KNIFE DRIVE	629214.1	1	1002317	4014486480054
	ELEVATOR DRIVE UNIT	629732.1	1	1000416	4014486466799
	REEL DRIVE ELEVATOR	670224.1	1	1001158	4014486497380
	TRACTION DRIVE	671012.1	1	1003631	4014486488500
		673638.1	1	1001099	4014486496819

## DOMINATOR 88

0		060306.2	1	1000723	4014486471151
0		060306.4	1	1000723	4014486471151
0	FOR CORN - CHOPPER	061213.0	1	1000860	4014486472943
0	FOR GRAIN - CHOPPER	061361.0	1	1000861	4014486472967
0		506671.1	1	1000506	4014486467840
0	SHAFTS DISTANCE 1306 MM	603290.0		1000764	4014486471670
0	ROTARY SCREEN	603341.0	1	1003328	4014486463217
0		609822.0	1	1001854	4014486488890



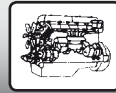
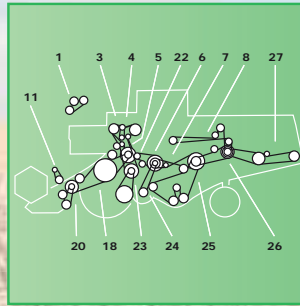
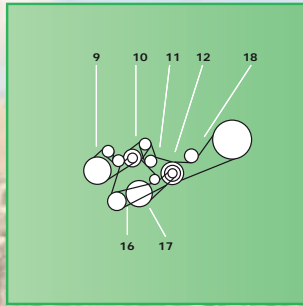
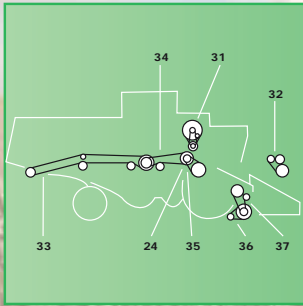

# CLAAS

0		609823.0	1	1001225	4014486497809
0	AT VAR. 7715	609823.0	1	1001225	4014486497809
0	AT N 650 - 1500 MIN-1	628630.0	1	1001208	4014486497670
0		629732.0	1	1000415	4014486466782
0		629732.1	1	1000416	4014486466799
0	FEEDER DRIVE SHAFTS DISTANCE 1177 MM	629836.0	1	1000746	4014486471427
0		629908.0	1	1002332	4014486478631
0		629908.1	1	1002332	4014486478631
0	AT N 500 - 1400 MIN-1	644177.0	1	1001221	4014486497762
0	AT VAR. 7715	661220.0	1	1003340	4014486488807
0	AT VAR. 7715	661220.1	1	1003340	4014486488807
0	AT 6.0 M - 6.6 M	671013.1	1	1000676	4014486470482
0		673625.0	1	1001793	4014486488005
0		673638.1	1	1001099	4014486496819
0	FOR HPH-G CHOPPER	680334.0	1	1001819	4014486488364
0	FOR HPH-G CHOPPER	680334.1	1	1001819	4014486488364
0	FOR CORN PICKER	692149.0	1	1001852	4014486488869
0	FOR CORN PICKER	692150.0	1	1001857	4014486488920
0	FOR HPH-G CHOPPER	695610.0	1	No AP	
0	AT 3.6 M - 5.1 M	713506.1	1	1000315	4014486465310
0	AT 3.6 M - 5.1 M	713506.2	1	1000315	4014486465310
1	HYDRAULIC PUMP	767057.1	1	1003333	4014486462609
3	DISCHARGE DRIVE GRAIN TANK	673614.1	1	1001566	4014486484694
4	TRACTION DRIVE	671012.1	1	1003631	4014486488500
5	FRONT WHEEL SHAFT	603337.0	1	1000662	4014486470260
6	SHAKER SHOE DRIVE	603336.0	1	1000478	4014486467499
6	SHAKER SHOE DRIVE	603336.1	1	1000478	4014486467499
7	STRAW WALKER DRIVE	629732.2	1	1000417	4014486520507
10	REEL DRIVE AT 3.6 M - 5.1 M	670224.1	1	1001158	4014486497380
10	REEL DRIVE AT 6.0 M - 6.6 M	670224.1	1	1001158	4014486497380
18	CLEANING FAN	671209.0	1	1001039	4014486496383
19	SHAKER SHOE DRIVE	603017.3	2	1000833	4014486472592
20	STRAW WALKER DRIVE	506671.2	1	1000506	4014486467840
21	STRAW WALKER DRIVE	635494.0	2	1000382	4014486466454
21	STRAW WALKER DRIVE	635494.1	2	1000382	4014486466454
27	FRONT WHEEL SHAFT	060306.3	1	No AP	
		603017.2	2	1000833	4014486472592
	FEEDER DRIVE SHAFTS DISTANCE 1177 MM	629836.1	2	1003819	4014486518870
	AT 3.6 M - 5.1 M	713506.0	1	1000315	4014486465310

# DOMINATOR 88 VX

0		060306.2	1	1000723	4014486471151
0		060306.4	1	1000723	4014486471151
0		506671.0	1	1000506	4014486467840
0		506671.1	1	1000506	4014486467840
0		603017.0	2	1000833	4014486472592
1		544048.0	1	1001933	4014486490299
2		767057.1	1	1003333	4014486462609
3		629908.0	1	1002332	4014486478631
3		629908.1	1	1002332	4014486478631
4		629769.0	1	1002699	4014486484922
4		629769.1	1	1002699	4014486484922
5		671012.1	1	1003631	4014486488500
6		603337.0	1	1000662	4014486470260
7		603336.0	1	1000478	4014486467499

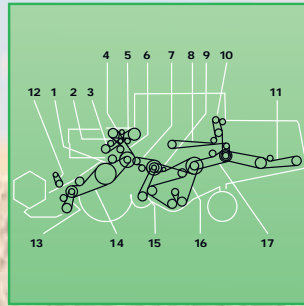
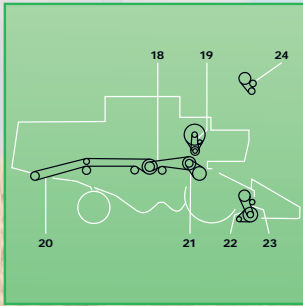

## CLAAS

7		603336.1	1	1000478	4014486467499
8		644447.0	1	1000420	4014486466836
9		635494.0	2	1000382	4014486466454
9		635494.1	2	1000382	4014486466454
10		661301.0	2	1000840	4014486472684
10		661301.1	2	1000840	4014486472684
11	FOR CORN	061213.0	1	1000860	4014486472943
11		061361.0	1	1000861	4014486472967
12		671209.0	1	1001039	4014486496383
13		603017.3	2	1000833	4014486472592
15		060306.3	1	No AP	
17		506671.2	1	1000506	4014486467840
18		661345.0	1	1000160	4014486461824
19		657793.0	1	1000107	4014486461114
20		628630.0	1	1001208	4014486497670
21		644448.0	1	1000139	4014486461565
22		609823.0	1	1001225	4014486497809
23		661220.0	1	1003340	4014486488807
23		661220.1	1	1003340	4014486488807
		603017.2	2	1000833	4014486472592

## DOMINATOR 96

0		603017.0	2	1000833	4014486472592
0		629732.0	1	1000415	4014486466782
0		673614.1	1	1001566	4014486484694
2		767057.1	1	1003333	4014486462609
3		673625.0	1	1001793	4014486488005
4		621903.0	1	1002041	4014486475166
4		621903.1	1	1002041	4014486475166
5		673614.0	1	1001566	4014486484694
6		671012.0	1	1003631	4014486488500
7		603337.0	1	1000662	4014486470260
8		629732.1	1	1000416	4014486466799
9		603336.0	1	1000478	4014486467499
9		603336.1	1	1000478	4014486467499
10		802931.0	1	1003456	4014486465945
11		623427.1	1	1000409	4014486466720
12		670224.0	1	1001158	4014486497380
13		629214.0	1	1002317	4014486480054
14		603122.0	1	1001116	4014486497007
15		671209.0	1	1001039	4014486496383
16		603017.3	2	1000833	4014486472592
17		506671.0	1	1000506	4014486467840
17		506671.1	1	1000506	4014486467840
17		506671.2	1	1000506	4014486467840
19		603341.0	1	1003328	4014486463217
20		061360.0	1	1000870	4014486473094
20		061360.1	1	1000870	4014486473094
21		603015.1	1	1001503	4014486460186
22		629410.0	2	1002872	4014486468441
23		680334.0	1	1001819	4014486488364
23		680334.1	1	1001819	4014486488364
24		603247.0	1	1003626	4014486488111
		603017.2	2	1000833	4014486472592
		603247.1	1	1003626	4014486488111

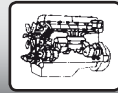
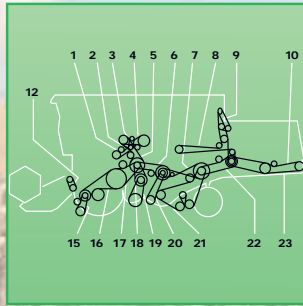
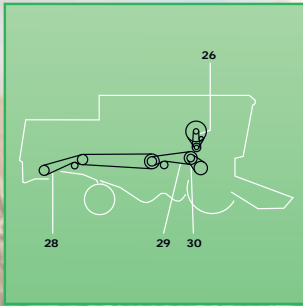

# CLAAS

		629214.1	1	1002317	4014486480054
		629410.1	2	1002872	4014486468441
		629732.2	1	1000417	4014486520507
		670224.1	1	1001158	4014486497380
		671012.1	1	1003631	4014486488500

## DOMINATOR 98

0	FOR STRAW CHOPPER	060306.2	1	1000723	4014486471151
0	FOR STRAW CHOPPER	060306.3	1	No AP	
0		603017.3	2	1000833	4014486472592
0		629732.2	1	1000417	4014486520507
0		673614.1	1	1001566	4014486484694
0		713506.2	1	1000315	4014486465310
0	MERCEDES ENGINE OM 360	767057.1	1	1003333	4014486462609
1	MERCEDES ENGINE OM 352A	629001.0	1	1001934	4014486490305
1	MERCEDES ENGINE OM 360	673625.0	1	1001793	4014486488005
2	MERCEDES ENGINE OM 352A + PERKINS ENGINE T63544	603378.0	1	1003388	4014486462524
2	MERCEDES ENGINE OM 360	767057.0	1	1003333	4014486462609
3	AIR CONDITION COMPRESSOR	629908.0	1	1002332	4014486478631
3	AIR CONDITION COMPRESSOR	629908.1	1	1002332	4014486478631
4	UNLOADER DRIVE	673614.0	1	1001566	4014486484694
5	MERCEDES ENGINE OM 352A + PERKINS ENGINE T63544	629000.0	1	1003661	4014486490657
5	MERCEDES ENGINE OM 360	671012.0	1	1003631	4014486488500
6	FRONT WHEEL SHAFT	603337.0	1	1000662	4014486470260
7	SHAKER SHOE DRIVE	603336.0	1	1000478	4014486467499
7	SHAKER SHOE DRIVE	603336.1	1	1000478	4014486467499
8	STRAW WALKER DRIVE	629732.0	1	1000415	4014486466782
9	STRAW WALKER DRIVE	802931.0	1	1003456	4014486465945
12	REEL DRIVE	670224.0	1	1001158	4014486497380
15	KNIFE DRIVE	713506.0	1	1000315	4014486465310
15	KNIFE DRIVE	713506.1	1	1000315	4014486465310
15	KNIFE DRIVE	713506.2	1	1000315	4014486465310
16	SHAFT BASE 1463 MM	061872.0	2	1002867	4014486471939
16	SHAFT BASE 1177 MM	629836.0	1	1000746	4014486471427
17	CUTTING TABLE	673638.0	1	1001099	4014486496819
18	TRACTION DRIVE	609822.0	1	1001854	4014486488890
19	CYLINDER DRIVE	609823.0	1	1001225	4014486497809
20	SHAKER SHOE DRIVE	671209.0	1	1001039	4014486496383
21	SHAKER SHOE DRIVE	603017.0	2	1000833	4014486472592
22	STRAW WALKER DRIVE	506671.0	1	1000506	401448647840
22	STRAW WALKER DRIVE	506671.1	1	1000506	4014486467840
22	STRAW WALKER DRIVE	506671.2	1	1000506	4014486467840
23	STRAW DISTRIBUTOR	623427.0	1	1000410	4014486466737
26	COOLER	603341.0	1	1003328	4014486463217
28	FOR STRAW CHOPPER	061214.0	1	1000868	4014486473070
28	FOR STRAW CHOPPER	061360.0	1	1000870	4014486473094
28	FOR STRAW CHOPPER	061360.1	1	1000870	4014486473094
29	FOR STRAW CHOPPER	060306.0	1	1000723	4014486471151
30	CYLINDER N=650-1500 RPM	628630.0	1	1001208	4014486497670
30	CYLINDER N=500-1400 RPM	644177.0	1	1001221	4014486497762
		603017.2	2	1000833	4014486472592
		623427.1	1	1000409	4014486466720
	MERCEDES ENGINE OM 352A + PERKINS ENGINE T63544	629000.1	1	1003661	4014486490657
	MERCEDES ENGINE OM 352A	629001.1	1	1001934	4014486490305
		629732.1	1	1000416	4014486466799

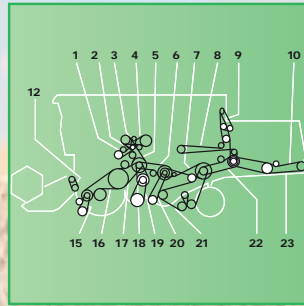
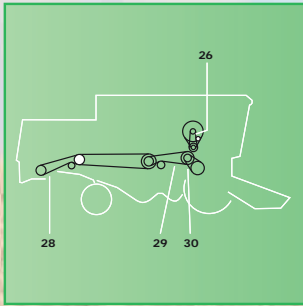

## CLAAS

	SHAFT BASE 1177 MM	629836.1	2	1003819	4014486518870
		670224.1	1	1001158	4014486497380
	MERCEDES ENGINE OM 360	671012.1	1	1003631	4014486488500
		673638.1	1	1001099	4014486496819

### DOMINATOR 98 VX

0		060306.2	1	1000723	4014486471151
0		060306.4	1	1000723	4014486471151
0		506671.0	1	1000506	4014486467840
0		506671.1	1	1000506	4014486467840
0		603017.0	2	1000833	4014486472592
0		755070.0	2	1002795	4014486463279
0		755070.2	2	1002795	4014486463279
1		544048.0	1	1001933	4014486490299
2		767057.1	1	1003333	4014486462609
3	AIR CONDITIONING COMPRESSOR DRIVE	629908.0	1	1002332	4014486478631
3	AIR CONDITIONING COMPRESSOR DRIVE	629908.1	1	1002332	4014486478631
4		629769.0	1	1002699	4014486484922
4		629769.1	1	1002699	4014486484922
5	THRESHING MACHINE	661458.0	1	1001957	4014486490640
6	FRONT WHEEL SHAFT	603337.0	1	1000662	4014486470260
7	SHAKER SHOE DRIVE	603336.0	1	1000478	4014486467499
7	SHAKER SHOE DRIVE	603336.1	1	1000478	4014486467499
9	STRAW WALKER DRIVE	802931.0	1	1003456	4014486465945
10	STRAW DISTRIBUTOR	623427.1	1	1000409	4014486466720
11	STRAW DISTRIBUTOR	755070.1	2	1002795	4014486463279
12	STRAW DISTRIBUTOR	066034.0	1	1000302	4014486465037
12	STRAW DISTRIBUTOR	785341.0	1	1000295	4014486464870
14	STRAW CHOPPER DRIVE	061214.0	1	1000868	4014486473070
15	SHAKER SHOE DRIVE	671209.0	1	1001039	4014486496383
16	KNIFE DRIVE	603017.3	2	1000833	4014486472592
18	COUNTERSHAFT	060306.3	1	No AP	
20	STRAW WALKER DRIVE	506671.2	1	1000506	4014486467840
21	COOLER	661345.0	1	1000160	4014486461824
22	COUNTERSHAFT	657793.0	1	1000107	4014486461114
23	CYLINDER DRIVE	644418.0	1	1001212	4014486497717
24	AIR EXHAUST	644448.0	1	1000139	4014486461565
25	CYLINDER DRIVE	609823.0	1	1001225	4014486497809
26	THRESHING MACHINE	661220.0	1	1003340	4014486488807
26	THRESHING MACHINE	661220.1	1	1003340	4014486488807
		603017.2	2	1000833	4014486472592
		644418.1	1	1001212	4014486497717
		661458.1	1	1001957	4014486490640

### EUROPA

0	HYDRAULIC PUMP DRIVE	755070.1	2	1002795	4014486463279
0	HYDRAULIC PUMP DRIVE	755070.2	2	1002795	4014486463279
0	RADIATOR FAN DRIVE	758662.1	1	1000240	4014486463484
0		772657.1	1	1000619	4014486469592
1	BALER	506880.0	1	1000901	4014486473476
2	KNIFE DRIVE	756051.0	1	1003508	4014486469240
3	TANK UNLOADER DRIVE	756051.0	1	1003508	4014486469240
3	TANK UNLOADER DRIVE	756059.0	1	1000889	4014486520286
4	RADIATOR FAN DRIVE	758662.0	1	1000240	4014486463484
4	RADIATOR FAN DRIVE	758719.0	1	1003405	4014486463309

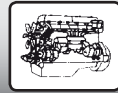

## CLAAS

5	CUTTING TABLE DRIVE	772657.0	1	1000619	4014486469592
6	SPREADER GRAIN IN TANK	775698.0	1	1000272	4014486464429
7	PICK UP DRIVE	800309.0	1	1003435	4014486464719
8	STRAW CHOPPER DRIVE	506940.0	1	1000934	4014486473858
10	HYDRAULIC PUMP DRIVE	755070.0	2	1002795	4014486463279
11	TRACTION DRIVE	750284.0	1	1000891	4014486473339
11	TRACTION DRIVE	750316.0	1	1000454	4014486467239
13	TRACTION DRIVE	751112.0	1	1001161	4014486497427
14	SHAKER SHOE FANBALER	772658.0	1	1000935	4014486473865
14	SHAKER SHOE FANBALER	772659.0	1	1000937	4014486473889
15	STRAW WALKER ELEVATOR	773313.0	1	1000480	4014486467512
15	STRAW WALKER ELEVATOR	774100.0	1	1003481	4014486467963
16	COUNTERSHAFT - STRAW CHOPPER	801221.0	1	1004103	4014486473315
22	CHAFF SPREADER DRIVE (LOWER)	123306A1	1	1002307	4014486479959

## JAGUAR 60

2	ANGLE GEAR BOX N=540 RPM	943227.0	2	1003760	4014486462951
4	ANGLE GEAR BOX N=1000 RPM	211148.0	1	1002114	4014486476156
4	ANGLE GEAR BOX N=1000 RPM	211148.1	1	1002114	4014486476156

## JAGUAR 675

0		673614.1	1	1001566	4014486484694
1	FEEDER DRIVE	629836.0	1	1000746	4014486471427
2		070310.1	1	1000380	4014486466430
3	FOR CORN - CRACKER	629769.0	1	1002699	4014486484922
3	FOR CORN - CRACKER	629769.1	1	1002699	4014486484922
4		070953.1	1	1002020	4014486491555
5		609823.0	1	1001225	4014486497809
6		644016.1	1	1001800	4014486488104
7	FOR HYDRAULIC PUMP	750193.1	1	1003399	4014486462937
7	FOR HYDRAULIC PUMP	750193.2	1	1003399	4014486462937
8	FOR AIR CONDITIONING	659025.0	1	1000094	4014486460926
9	FOR CORN - CRACKER	072110.0	1	1001182	4014486490206
10		673614.0	1	1001566	4014486484694
14	FOR ALTERNATOR AT OM 421	133528.0	1	1002560	4014486495102
15	COOLING AT OM 421	133630.1	2	1002961	4014486495058
15	COOLING AND ALTERNATOR AT OM 360	685693.0	2	1003773	4014486495065
	FEEDER DRIVE	629836.1	2	1003819	4014486518870

## JAGUAR 675 HYDRO

0		673614.1	1	1001566	4014486484694
0	FOR HYDRAULIC PUMP	750193.1	1	1003399	4014486462937
1	FEEDER DRIVE	629836.0	1	1000746	4014486471427
2		070310.1	1	1000380	4014486466430
3	FOR CORN CRACKER	629769.0	1	1002699	4014486484922
3	FOR CORN CRACKER	629769.1	1	1002699	4014486484922
4		070953.1	1	1002020	4014486491555
5	FOR HYDRAULIC PUMP	750193.2	1	1003399	4014486462937
6	FOR AIR CONDITIONING	659025.0	1	1000094	4014486460926
7		176543.1	1	1001793	4014486488005
9	FOR CORN CRACKER	072110.0	1	1001182	4014486490206
10		673614.0	1	1001566	4014486484694
13	FOR ALTERNATOR	133528.0	1	1002560	4014486495102

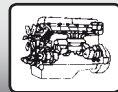

## CLAAS

14	FOR COOLING	133630.1	2	1002961	4014486495058
	FEEDER DRIVE	629836.1	2	1003819	4014486518870

### JAGUAR 680

0		673614.1	1	1001566	4014486484694
0	FOR HYDRAULIC PUMP	750193.1	1	1003399	4014486462937
1	FEEDER DRIVE	629836.0	1	1000746	4014486471427
2		070310.1	1	1000380	4014486466430
3	FOR CORN CRACKER	629769.0	1	1002699	4014486484922
3	FOR CORN CRACKER	629769.1	1	1002699	4014486484922
4		070953.1	1	1002020	4014486491555
5		609823.0	1	1001225	4014486497809
6		644016.1	1	1001800	4014486488104
7	FOR HYDRAULIC PUMP	750193.2	1	1003399	4014486462937
8	FOR AIR CONDITIONING	659025.0	1	1000094	4014486460926
9	FOR CORN CRACKER	072110.0	1	1001182	4014486490206
10		673614.0	1	1001566	4014486484694
14	FOR ALTERNATOR AT OM 421	133528.0	1	1002560	4014486495102
15	COOLING AT OM 421	133630.1	2	1002961	4014486495058
15	COOLING AND ALTERNATOR AT OM 360	685693.0	2	1003773	4014486495065
	FEEDER DRIVE	629836.1	2	1003819	4014486518870

### JAGUAR 680 HYDRO

0		673614.1	1	1001566	4014486484694
0	FOR HYDRAULIC PUMP	750193.1	1	1003399	4014486462937
1		629836.0	1	1000746	4014486471427
2		070310.1	1	1000380	4014486466430
3	FOR CORN CRACKER	629769.0	1	1002699	4014486484922
3	FOR CORN CRACKER	629769.1	1	1002699	4014486484922
4		070953.1	1	1002020	4014486491555
5	FOR HYDRAULIC PUMP	750193.2	1	1003399	4014486462937
6	FOR AIR CONDITIONING	659025.0	1	1000094	4014486460926
7		176543.1	1	1001793	4014486488005
9	FOR CORN CRACKER	072110.0	1	1001182	4014486490206
10		673614.0	1	1001566	4014486484694
13	FOR ALTERNATOR	133528.0	1	1002560	4014486495102
14	FOR COOLING	133630.1	2	1002961	4014486495058
		629836.1	2	1003819	4014486518870

### JAGUAR 682

0	FOR ACCELERATOR	629732.0	1	1000415	4014486466782
0	FOR ACCELERATOR	629732.1	1	1000416	4014486466799
0	AT 6G - TRANSMISSION	673614.1	1	1001566	4014486484694
1	FOR ACCELERATOR	629732.2	1	1000417	4014486520507
2	FOR SLIP DRIVE	070310.1	1	1000380	4014486466430
3	FOR HYDRAULIC PUMP FROM NO. 18600322	634019.0	2	1002792	4014486464368
3	FOR HYDRAULIC PUMP FROM NO. 18600322	634019.1	2	1002792	4014486464368
3	FOR HYDRAULIC PUMP FROM NO. 18600322	634019.2	2	1002792	4014486464368
3	FOR HYDRAULIC PUMP TO NO. 18600321	750294.0	1	1000251	4014486463897
7	FOR CORN CRACKER	629763.0	1	1003593	4014486484977
8	FOR CHOPPER DRUM	073202.1	1	1002012	4014486491425
9	AT HYDRAULIC GROUND DRIVE	073203.0	1	1001810	4014486488227
9	AT HYDRAULIC GROUND DRIVE	073203.1	1	1001810	4014486488227
9	AT MECHANICAL GROUND DRIVE	629756.0	1	1001209	4014486497687
10	MOTOR - INTERMEDIATE DRIVE FROM NO. 18600322	073199.0	1	1002004	4014486491319

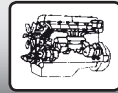
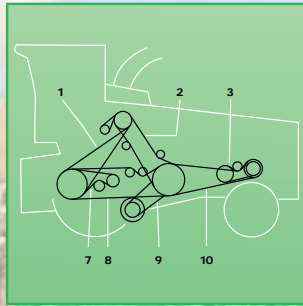
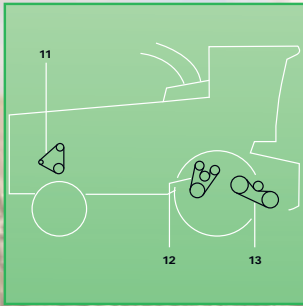

## CLAAS

10	MOTOR - INTERMEDIATE DRIVE TO NO. 18600321	073201.1	1	1002004	4014486491319
11	ALTERNATOR MERCEDES FROM NO. 18600322	133641.0	1	1002596	4014486496017
11	ALTERNATOR PERKINS TO NO. 18600321	602387.1	2	1002956	4014486495720
12	FOR CORN CRACKER	073204.0	1	1001183	4014486490213
12	FOR CORN CRACKER	073204.1	1	1001183	4014486490213
13	AT 4G - CHAIN DRIVE	644015.1	1	1002913	4014486484601
13	AT 6G - TRANSMISSION	673614.0	1	1001566	4014486484694

## JAGUAR 682 S

0	ENGINE	073201.1	1	1002004	4014486491319
0	THRESHING DRUM VARIATOR DRIVE	073202.1	1	1002012	4014486491425
1	DRUM DRIVE VARIABLE SPEED	629732.2	1	1000417	4014486520507
2	STRAW WALKER DRIVE	070310.1	1	1000380	4014486466430
3	HYDRAULIC PUMP DRIVE	750294.0	1	1000251	4014486463897
7	CORN CRACKER DRIVE	629763.0	1	1003593	4014486484977
8	THRESHING DRUM VARIATOR DRIVE	073202.0	1	1002012	4014486491425
9	HYDROSTATIC SPEED DRIVE	073203.0	1	1001810	4014486488227
9	HYDROSTATIC SPEED DRIVE	073203.1	1	1001810	4014486488227
9	MECHANICAL DRIVE	629756.0	1	1001209	4014486497687
10	ENGINE	073201.0	1	1002004	4014486491319
11	ALTERNATOR DRIVE	602387.0	2	1002956	4014486495720
12	CORN CRACKER DRIVE	073204.0	1	1001183	4014486490213
12	CORN CRACKER DRIVE	073204.1	1	1001183	4014486490213
13	FEEDER DRIVE	644015.1	1	1002913	4014486484601
13	FEEDER DRIVE	673614.0	1	1001566	4014486484694

## JAGUAR 682 SL

0	ENGINE	073201.1	1	1002004	4014486491319
0	THRESHING DRUM VARIATOR DRIVE	073202.1	1	1002012	4014486491425
1	DRUM DRIVE VARIABLE SPEED	629732.2	1	1000417	4014486520507
2	STRAW WALKER DRIVE	070310.1	1	1000380	4014486466430
3	HYDRAULIC PUMP DRIVE	750294.0	1	1000251	4014486463897
7	CORN CRACKER DRIVE	629763.0	1	1003593	4014486484977
8	THRESHING DRUM VARIATOR DRIVE	073202.0	1	1002012	4014486491425
9	HYDROSTATIC SPEED DRIVE	073203.0	1	1001810	4014486488227
9	HYDROSTATIC SPEED DRIVE	073203.1	1	1001810	4014486488227
9	MECHANICAL DRIVE	629756.0	1	1001209	4014486497687
10	ENGINE	073201.0	1	1002004	4014486491319
11	ALTERNATOR DRIVE	602387.0	2	1002956	4014486495720
12	CORN CRACKER DRIVE	073204.0	1	1001183	4014486490213
12	CORN CRACKER DRIVE	073204.1	1	1001183	4014486490213
13	FEEDER DRIVE	644015.1	1	1002913	4014486484601
13	FEEDER DRIVE	673614.0	1	1001566	4014486484694

## JAGUAR 682S

0	ALTERNATOR DRIVE	602387.0	2	1002956	4014486495720
0	ALTERNATOR DRIVE	602387.1	2	1002956	4014486495720
0	DRUM DRIVE VARIABLE SPEED	629732.0	1	1000415	4014486466782
0	DRUM DRIVE VARIABLE SPEED	629732.1	1	1000416	4014486466799
0	DRUM DRIVE VARIABLE SPEED	629732.2	1	1000417	4014486520507
0	FEEDER DRIVE	673614.0	1	1001566	4014486484694
0	FEEDER DRIVE	673614.1	1	1001566	4014486484694

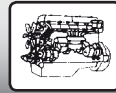
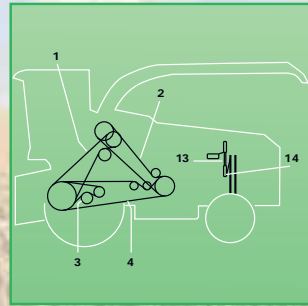
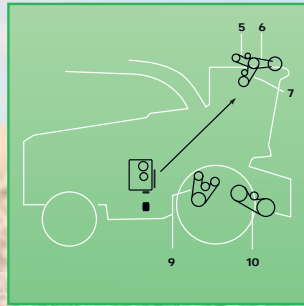
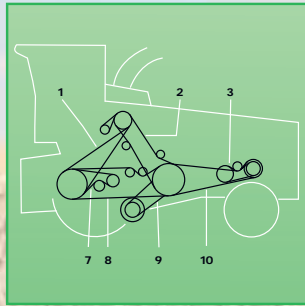
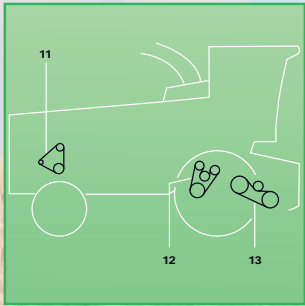

# CLAAS

## JAGUAR 682SL

0	ALTERNATOR DRIVE	602387.0	2	1002956	4014486495720
0	ALTERNATOR DRIVE	602387.1	2	1002956	4014486495720
0	DRUM DRIVE VARIABLE SPEED	629732.0	1	1000415	4014486466782
0	DRUM DRIVE VARIABLE SPEED	629732.1	1	1000416	4014486466799
0	DRUM DRIVE VARIABLE SPEED	629732.2	1	1000417	4014486520507
0	FEEDER DRIVE	673614.0	1	1001566	4014486484694
0	FEEDER DRIVE	673614.1	1	1001566	4014486484694

## JAGUAR 685

0	COOLING FAN	133630.1	2	1002961	4014486495058
0	HYDRAULIC SPEED DRIVE	176543.1	1	1001793	4014486488005
0	CHOPPER DRIVE	673614.1	1	1001566	4014486484694
0	FOR COMBINE PLATFORM	673614.1	1	1001566	4014486484694
0	HYDRAULIC PUMP DRIVE	750193.1	1	1003399	4014486462937
1	DRUM DRIVE	629836.0	1	1000746	4014486471427
2	FEEDER DRIVE	070310.1	1	1000380	4014486466430
3	LEFT CORN-CRACKER DRIVE	629769.0	1	1002699	4014486484922
3	LEFT CORN-CRACKER DRIVE	629769.1	1	1002699	4014486484922
4	HEAD DRUM DRIVE	070952.0	1	1001264	4014486492293
4	HEAD DRUM DRIVE	070952.1	1	1001264	4014486492293
4	HEAD DRUM DRIVE	070952.2	1	1001264	4014486492293
5	HYDRAULIC PUMP DRIVE	750193.2	1	1003399	4014486462937
6	AIR CONDITIONING COMPRESSOR DRIVE	659025.0	1	1000094	4014486460926
7	HYDRAULIC SPEED DRIVE	176543.0	1	1001793	4014486488005
7	HYDRAULIC SPEED DRIVE	673625.0	1	1001793	4014486488005
9	CORN - CRACKER DRIVE RIGHT	072110.0	1	1001182	4014486490206
10	CHOPPER DRIVE	673614.0	1	1001566	4014486484694
13	ALTERNATOR DRIVE	133528.0	1	1002560	4014486495102
14	COOLING FAN	133630.0	2	1002961	4014486495058
15	FOR COMBINE PLATFORM	673614.0	1	1001566	4014486484694
	DRUM DRIVE	629836.1	2	1003819	4014486518870

## JAGUAR 685 SL

0	COOLING FAN	133630.1	2	1002961	4014486495058
0	DRUM DRIVE VARIABLE SPEED	176543.1	1	1001793	4014486488005
0	FEEDER DRIVE	673614.1	1	1001566	4014486484694
0	FOR COMBINE PLATFORM	673614.1	1	1001566	4014486484694
0	HYDRAULIC PUMP DRIVE	750193.1	1	1003399	4014486462937
1	DRUM DRIVE	629836.0	1	1000746	4014486471427
2	FEEDER DRIVE	070310.1	1	1000380	4014486466430
3	ALTERNATOR DRIVE	133528.0	1	1002560	4014486495102
4	COOLING FAN	133630.0	2	1002961	4014486495058
5	CORN CRACKER DRIVE	629769.0	1	1003593	4014486484977
6	FOR JAGUAR 690/685 SL	070952.0	1	1001264	4014486492293
6	FOR JAGUAR 690/685 SL	070952.1	1	1001264	4014486492293
6	FOR JAGUAR 690/685 SL	070952.2	1	1001264	4014486492293
6	FOR JAGUAR 690/685 SL	074803.0	1	1001266	4014486492316
6	FOR JAGUAR 690/685 SL	074803.1	1	1001266	4014486492316
6	AT JAGUAR 685 SL FROM NO. 18800012	074803.2	1	1001266	4014486492316
7	HYDRAULIC PUMP DRIVE	750193.2	1	1003399	4014486462937
8	AIR CONDITIONING COMPRESSOR DRIVE	659025.0	1	1000094	4014486460926
9	DRUM DRIVE VARIABLE SPEED	176543.0	1	1001793	4014486488005
10	CORN CRACKER DRIVE	073204.0	1	1001183	4014486490213



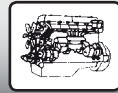
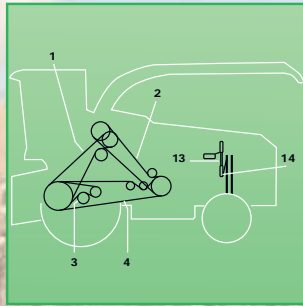
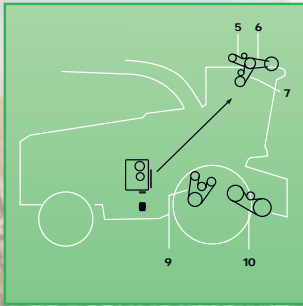

# CLAAS

10	CORN CRACKER DRIVE	073204.1	1	1001183	4014486490213
11	FEEDER DRIVE	673614.0	1	1001566	4014486484694
15	FOR COMBINE PLATFORM DRUM DRIVE	673614.0	1	1001566	4014486484694
		629836.1	2	1003819	4014486518870

## JAGUAR 690

0	COOLING FAN	133630.1	2	1002961	4014486495058
0	HYDRAULIC SPEED DRIVE	176543.1	1	1001793	4014486488005
0	CHOPPER DRIVE	673614.1	1	1001566	4014486484694
0	FOR COMBINE PLATFORM	673614.1	1	1001566	4014486484694
0	HYDRAULIC PUMP DRIVE	750193.1	1	1003399	4014486462937
1	DRUM DRIVE	629836.0	1	1000746	4014486471427
2	FEEDER DRIVE	070310.1	1	1000380	4014486466430
3	LEFT CORN-CRACKER DRIVE	629769.0	1	1002699	4014486484922
3	LEFT CORN-CRACKER DRIVE	629769.1	1	1002699	4014486484922
4	HEAD DRUM DRIVE	070952.0	1	1001264	4014486492293
4	HEAD DRUM DRIVE	070952.1	1	1001264	4014486492293
4	HEAD DRUM DRIVE	070952.2	1	1001264	4014486492293
5	HYDRAULIC PUMP DRIVE	750193.2	1	1003399	4014486462937
6	AIR CONDITIONING COMPRESSOR DRIVE	659025.0	1	1000094	4014486460926
7	HYDRAULIC SPEED DRIVE	176543.0	1	1001793	4014486488005
7	HYDRAULIC SPEED DRIVE	673625.0	1	1001793	4014486488005
9	CORN - CRACKER DRIVE RIGHT	072110.0	1	1001182	4014486490206
10	CHOPPER DRIVE	673614.0	1	1001566	4014486484694
13	ALTERNATOR DRIVE	133528.0	1	1002560	4014486495102
14	COOLING FAN	133630.0	2	1002961	4014486495058
15	FOR COMBINE PLATFORM DRUM DRIVE	673614.0	1	1001566	4014486484694
		629836.1	2	1003819	4014486518870

## JAGUAR 690 SL

0	AT JAGUAR 690 SL FROM NO. 18800012	074803.0	1	1001266	4014486492316
0	AT JAGUAR 690 SL FROM NO. 18800012	074803.1	1	1001266	4014486492316
0	FOR FEEDER DRIVE	673614.1	1	1001566	4014486484694
0	FOR HYDRAULIC PUMP	750193.1	1	1003399	4014486462937
1	FOR ACCELERATOR	629836.0	1	1000746	4014486471427
1	FOR ACCELERATOR	629836.1	2	1003819	4014486518870
2	FOR SLIP DRIVE	070310.1	1	1000380	4014486466430
3	FOR ALTERNATOR	133528.0	1	1002560	4014486495102
4	FOR MOTOR COOLING	133630.1	2	1002961	4014486495058
5	FOR CORN CRACKER	629763.0	1	1003593	4014486484977
6	AT JAGUAR 690 SL TO NO. 18800011	070952.0	1	1001264	4014486492293
6	AT JAGUAR 690 SL TO NO. 18800011	070952.1	1	1001264	4014486492293
6	AT JAGUAR 690 SL TO NO. 18800011	070952.2	1	1001264	4014486492293
6	AT JAGUAR 690 SL FROM NO. 18800012	074803.2	1	1001266	4014486492316
7	FOR HYDRAULIC PUMP	750193.2	1	1003399	4014486462937
8	FOR AIR CONDITIONING	659025.0	1	1000094	4014486460926
9	FOR GROUND DRIVE	176543.1	1	1001793	4014486488005
10	FOR CORN CRACKER	073204.0	1	1001183	4014486490213
10	FOR CORN CRACKER	073204.1	1	1001183	4014486490213
11	FOR FEEDER DRIVE	673614.0	1	1001566	4014486484694

AG - BI  
CA - CL  
DE - DR  
FE - FO  
GO - GR  
IN - JO  
KP - KZ  
LA - ME  
NE - RO  
SA - ST  
VA - ZM  
PARTS  
SERVICE

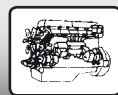
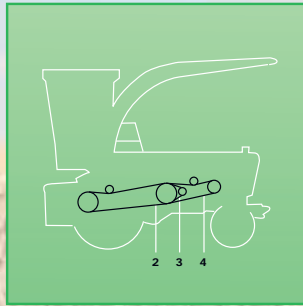
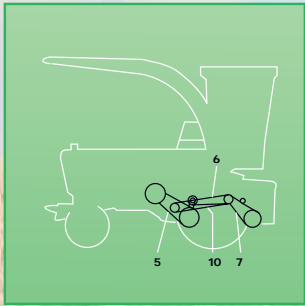

# CLAAS

## JAGUAR 695 SL

0	COOLING FAN	133630.1	2	1002961	4014486495058
0	DRUM DRIVE VARIABLE SPEED	176543.1	1	1001793	4014486488005
0	FEEDER DRIVE	673614.1	1	1001566	4014486484694
0	FOR COMBINE PLATFORM	673614.1	1	1001566	4014486484694
0	HYDRAULIC PUMP DRIVE	750193.1	1	1003399	4014486462937
1	DRUM DRIVE	629836.0	1	1000746	4014486471427
2	FEEDER DRIVE	070310.1	1	1000380	4014486466430
3	ALTERNATOR DRIVE	133528.0	1	1002560	4014486495102
4	COOLING FAN	133630.0	2	1002961	4014486495058
5	CORN CRACKER DRIVE	629763.0	1	1003593	4014486484977
6	FOR JAGUAR 695 SL	074771.0	1	1001267	4014486492323
6	FOR JAGUAR 695 SL	074771.1	1	1001267	4014486492323
6	FOR JAGUAR 695 SL	074771.2	1	1001267	4014486492323
7	HYDRAULIC PUMP DRIVE	750193.2	1	1003399	4014486462937
8	AIR CONDITIONING COMPRESSOR DRIVE	659025.0	1	1000094	4014486460926
9	DRUM DRIVE VARIABLE SPEED	176543.0	1	1001793	4014486488005
10	CORN CRACKER DRIVE	073204.0	1	1001183	4014486490213
10	CORN CRACKER DRIVE	073204.1	1	1001183	4014486490213
11	FEEDER DRIVE	673614.0	1	1001566	4014486484694
15	FOR COMBINE PLATFORM	673614.0	1	1001566	4014486484694
	DRUM DRIVE	629836.1	2	1003819	4014486518870

## JAGUAR 70 SF

0	HYDRAULIC PUMP DRIVE	633030.0	1	1000220	4014486462838
2	DRUM DRIVE VARIABLE SPEED	063309.0	1	1002003	4014486491296
3	HYDRAULIC PUMP DRIVE	633030.1	1	1000220	4014486462838
4	ENGINE	063285.0	1	1001245	4014486492002
5	DRUM DRIVE VARIABLE SPEED	629737.0	1	1001511	4014486460285
6	FEEDER DRIVE	618123.0	1	1003434	4014486464634
7	FEEDER DRIVE	063940.0	1	1000580	4014486468977
10	FEEDER DRIVE	062294.0	1	1001351	4014486474640
	HYDRAULIC PUMP DRIVE	633030.2	1	1000220	4014486462838

## JAGUAR 71

1	FEEDER SHAFT (UPPER)	981678.0	1	1001547	4014486484465
---	----------------------	----------	---	---------	---------------

## JAGUAR 75

1	FEEDER SHAFT (UPPER)	981678.0	1	1001547	4014486484465
---	----------------------	----------	---	---------	---------------

## JAGUAR 800

0	FOR ACCELERATOR	629732.0	1	1000415	4014486466782
0	FOR ACCELERATOR	629732.1	1	1000416	4014486466799
1	FOR ACCELERATOR	629732.2	1	1000417	4014486520507
2	FOR SLIP DRIVE	070310.1	1	1000380	4014486466430
3	FOR HYDRAULIC PUMP	634019.0	2	1002792	4014486464368
3	FOR HYDRAULIC PUMP	634019.1	2	1002792	4014486464368
3	FOR HYDRAULIC PUMP	634019.2	2	1002792	4014486464368
4	FOR CORN CRACKER	629763.0	1	1003593	4014486484977
5	FOR CHOPPER DRUM	073202.1	1	1002012	4014486491425
6	AT HYDRAULIC GROUND DRIVE	073203.0	1	1001810	4014486488227
6	AT HYDRAULIC GROUND DRIVE	073203.1	1	1001810	4014486488227
6	AT MECHANICAL GROUND DRIVE	629756.0	1	1001209	4014486497687
7	MOTOR - INTERMEDIATE DRIVE	073199.0	1	1002004	4014486491319



## CLAAS

8	FOR AIR CONDITIONING	667560.0	1	1002597	4014486496024
8	FOR AIR CONDITIONING	667560.1	1	1002597	4014486496024
9	FOR ALTERNATOR	133641.0	1	1002596	4014486496017
10	FOR CORN CRACKER	073204.0	1	1001183	4014486490213
10	FOR CORN CRACKER	073204.1	1	1001183	4014486490213
11	FOR FEEDER HOUSING	673614.1	1	1001566	4014486484694

### JAGUAR 820

1	MAIN DRIVE	077796.0	1	1001314	4014486492774
1	MAIN DRIVE	077797.0	1	1001270	4014486492378
2	ALTERNATOR DRIVE	512087.0	1	1002588	4014486495812
3	COMPRESSOR DRIVE	052393.1	1	1000122	4014486461336
4	FAN DRIVE	077400.0	1	1000282	4014486464597
5	CLEANING FAN DRIVE	077276.0	1	1000177	4014486462067
6	CORN CRACKER DRIVE	076403.1	1	1001186	4014486490244

### JAGUAR 830

0	CHOPPER DRIVE	984885.1	1	1001810	4014486488227
1	MAIN DRIVE	067745.0	1	1001271	4014486492385
2	FAN DRIVE FOR OM 502 LA	067289.0	1	1004700	4014486716474
2	FAN DRIVE FOR OM 457 LA	067290.0	1	1004463	4014486712155
2	FAN DRIVE FOR OM 460 LA	142232.0	1	1003950	4014486483581
3	CORN CRACKER DRIVE	067789.0	1	1001292	4014486492446
3	CORN CRACKER DRIVE	076403.1	1	1001186	4014486490244
4	CHOPPER DRIVE	984885.0	1	1001810	4014486488227
4	CHOPPER DRIVE	987883.0	1	1001943	4014486490435

### JAGUAR 840

1	MAIN DRIVE	077796.0	1	1001314	4014486492774
1	MAIN DRIVE	077797.0	1	1001270	4014486492378
2	ALTERNATOR DRIVE	512087.0	1	1002588	4014486495812
3	COMPRESSOR DRIVE	052393.1	1	1000122	4014486461336
4	FAN DRIVE	077400.0	1	1000282	4014486464597
5	CLEANING FAN DRIVE	077276.0	1	1000177	4014486462067
6	CORN CRACKER DRIVE	076403.1	1	1001186	4014486490244

### JAGUAR 85

0		633030.0	1	1000220	4014486462838
0	GRAIN TANK UNLOADING	673614.1	1	1001566	4014486484694
2	GRAIN TANK UNLOADING	673614.0	1	1001566	4014486484694
6		633030.2	1	1000220	4014486462838
		633030.1	1	1000220	4014486462838

### JAGUAR 850

0	CHOPPER DRIVE	984885.1	1	1001810	4014486488227
1	MAIN DRIVE	067746.0	1	1001315	4014486492781
2	FAN DRIVE FOR OM 502 LA	067289.0	1	1004700	4014486716474
2	FAN DRIVE FOR OM 457 LA	067290.0	1	1004463	4014486712155
2	FAN DRIVE FOR OM 460 LA	142232.0	1	1003950	4014486483581
3	CORN CRACKER DRIVE	067789.0	1	1001292	4014486492446
3	CORN CRACKER DRIVE	076403.1	1	1001186	4014486490244
4	CHOPPER DRIVE	984885.0	1	1001810	4014486488227
4	CHOPPER DRIVE	987883.0	1	1001943	4014486490435

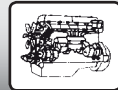
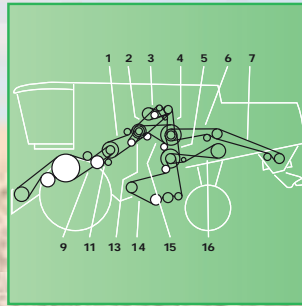
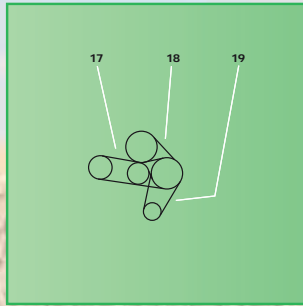
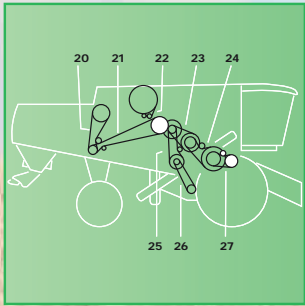

# CLAAS

## JAGUAR 8500 C

0		721211.0	1	1000115	4014486461237
---	--	----------	---	---------	---------------

## JAGUAR 8550

0		721211.0	1	1000115	4014486461237
---	--	----------	---	---------	---------------

## JAGUAR 870

0	CHOPPER DRIVE	984885.1	1	1001810	4014486488227
1	MAIN DRIVE	067746.0	1	1001315	4014486492781
2	FAN DRIVE FOR OM 502 LA	067289.0	1	1004700	4014486716474
2	FAN DRIVE FOR OM 457 LA	067290.0	1	1004463	4014486712155
2	FAN DRIVE FOR OM 460 LA	142232.0	1	1003950	4014486483581
3	CORN CRACKER DRIVE	067789.0	1	1001292	4014486492446
3	CORN CRACKER DRIVE	076403.1	1	1001186	4014486490244
4	CHOPPER DRIVE	984885.0	1	1001810	4014486488227
4	CHOPPER DRIVE	987883.0	1	1001943	4014486490435

## JAGUAR 8700

0		721211.0	1	1000115	4014486461237
---	--	----------	---	---------	---------------

## JAGUAR 890

0	CHOPPER DRIVE	984885.1	1	1001810	4014486488227
1	MAIN DRIVE	067747.0	1	1001325	4014486492880
1	MAIN DRIVE	067747.1	1	1001325	4014486492880
2	FAN DRIVE FOR OM 502 LA	067289.0	1	1004700	4014486716474
2	FAN DRIVE FOR OM 457 LA	067290.0	1	1004463	4014486712155
2	FAN DRIVE FOR OM 460 LA	142232.0	1	1003950	4014486483581
3	CORN CRACKER DRIVE	067789.0	1	1001292	4014486492446
3	CORN CRACKER DRIVE	076403.1	1	1001186	4014486490244
4	CHOPPER DRIVE	984885.0	1	1001810	4014486488227
4	CHOPPER DRIVE	987883.0	1	1001943	4014486490435

## JAGUAR 900

0	CHOPPER DRIVE	984885.1	1	1001810	4014486488227
1	MAIN DRIVE	067747.1	1	1001325	4014486492880
2	FAN DRIVE FOR OM 502 LA	067289.0	1	1004700	4014486716474
2	FAN DRIVE FOR OM 457 LA	067290.0	1	1004463	4014486712155
2	FAN DRIVE FOR OM 460 LA	142232.0	1	1003950	4014486483581
3	CORN CRACKER DRIVE	067789.0	1	1001292	4014486492446
3	CORN CRACKER DRIVE	076403.1	1	1001186	4014486490244
4	CHOPPER DRIVE	984885.0	1	1001810	4014486488227
4	CHOPPER DRIVE	987883.0	1	1001943	4014486490435

## LEXION 405

0	SIEVE PAN DRIVE - 1ST STAGE	644209.2	1	1004843	4014486715668
0	THRESHING DRUM VARIATOR DRIVE	667248.0	1	1001317	4014486497908
0	THRESHING DRUM VARIATOR DRIVE	667248.1	1	1001317	4014486497908
0	THRESHING DRUM VARIATOR DRIVE	667248.2	1	1001317	4014486497908
0	STRAW CHOPPER DRIVE - 1ST STAGE	667981.0	1	1001589	4014486485011
0	KNIFE DRIVE	742025.0	1	1000650	4014486470123
1	CUTTERBAR DRIVE	667947.0	1	1001633	4014486485783
2	THRESHING MACHINE	667680.0	1	1003353	4014486490978
3	DISCHARGE DRIVE GRAIN TANK	667681.0	1	1001583	4014486484908
4	STRAW CHOPPER DRIVE - 1ST STAGE	667981.2	1	1001588	4014486484991

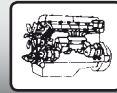
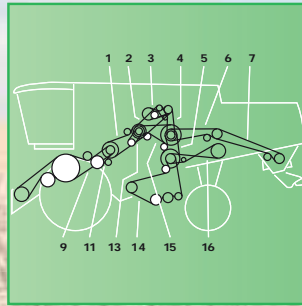
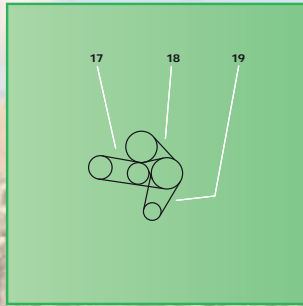
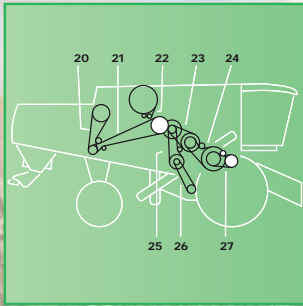

## CLAAS

5	SIEVE PAN DRIVE - 2ND STAGE	667252.0	1	1003602	4014486485349
6	STRAW CHOPPER DRIVE - 2ND STAGE	667683.0	1	1000738	4014486471335
7	STRAW CHOPPER DRIVE - 2ND STAGE	644771.0	1	1000752	4014486471519
9	CUTTERBAR DRIVE	667454.0	2	1002870	4014486472981
11	IMPELLER DRUM DRIVE	667249.0	1	1003591	4014486484762
13	HYDRAULIC PUMP DRIVE	758719.0	1	1003405	4014486463309
14	SIEVE PAN DRIVE 2RD STAGE	667651.0	1	1001706	4014486486834
15	SIEVE PAN DRIVE - 1ST STAGE	644209.0	1	1000699	4014486470826
15	SIEVE PAN DRIVE - 1ST STAGE	644209.1	1	1004843	4014486715668
16	STRAW WALKER DRIVE	667477.0	1	1000387	4014486466508
17	COMPRESSOR DRIVE	667560.0	1	1002597	4014486496024
17	COMPRESSOR DRIVE	667560.1	1	1002597	4014486496024
18	ROTARY SCREEN FAN AND DRIVE	667242.0	1	1000225	4014486463033
19	ALTERNATOR DRIVE STARTER	667673.0	1	1002549	4014486494815
20	AGITATOR DRIVE (REAR)	667973.0	1	1000340	4014486465877
21	AGITATOR DRIVE (FRONT)	667974.0	1	1000411	4014486466744
22	ROTARY SCREEN DRIVE	667561.1	1	1000168	4014486461930
23	THRESHING DRUM VARIATOR DRIVE	661427.0	1	1001228	4014486497847
24	THRESHING CYLINDER	667934.0	1	1001645	4014486485974
25	FAN DRIVE - 1ST STAGE	667957.0	1	1000320	4014486465396
26	FAN INTERMEDIATE DRIVE	667457.0	1	1001079	4014486498233
27	THRESHING DRUM VARIATOR DRIVE	667251.0	1	1003601	4014486485219
	THRESHING DRUM VARIATOR DRIVE	667251.1	1	1003601	4014486485219
	CUTTERBAR DRIVE	667454.1	2	1002870	4014486472981
	STRAW CHOPPER DRIVE - 2ND STAGE	667683.1	1	1000738	4014486471335
	CUTTERBAR DRIVE	667947.1	1	1004537	4014486720853
	STRAW CHOPPER DRIVE - 1ST STAGE	667981.1	1	1001589	4014486485011

## LEXION 410

0	SIEVE PAN DRIVE - 1ST STAGE	644209.2	1	1004843	4014486715668
0	THRESHING DRUM VARIATOR DRIVE	667248.0	1	1001317	4014486497908
0	THRESHING DRUM VARIATOR DRIVE	667248.1	1	1001317	4014486497908
0	THRESHING DRUM VARIATOR DRIVE	667248.2	1	1001317	4014486497908
0	STRAW CHOPPER DRIVE - 1ST STAGE	667981.0	1	1001589	4014486485011
0	KNIFE DRIVE	742025.0	1	1000650	4014486470123
1	CUTTERBAR DRIVE	667947.0	1	1001633	4014486485783
2	THRESHING MACHINE	667680.0	1	1003353	4014486490978
3	DISCHARGE DRIVE GRAIN TANK	667681.0	1	1001583	4014486484908
4	STRAW CHOPPER DRIVE - 1ST STAGE	667981.2	1	1001588	4014486484991
5	SIEVE PAN DRIVE - 2ND STAGE	667252.0	1	1003602	4014486485349
6	STRAW CHOPPER DRIVE - 2ND STAGE	667683.0	1	1000738	4014486471335
7	STRAW CHOPPER DRIVE - 2ND STAGE	644771.0	1	1000752	4014486471519
9	CUTTERBAR DRIVE	667454.0	2	1002870	4014486472981
11	IMPELLER DRUM DRIVE	667249.0	1	1003591	4014486484762
13	HYDRAULIC PUMP DRIVE	758719.0	1	1003405	4014486463309
14	SIEVE PAN DRIVE 2RD STAGE	667651.0	1	1001706	4014486486834
15	SIEVE PAN DRIVE - 1ST STAGE	644209.0	1	1000699	4014486470826
15	SIEVE PAN DRIVE - 1ST STAGE	644209.1	1	1004843	4014486715668
16	STRAW WALKER DRIVE	667477.0	1	1000387	4014486466508
17	COMPRESSOR DRIVE	667560.0	1	1002597	4014486496024
17	COMPRESSOR DRIVE	667560.1	1	1002597	4014486496024
18	ROTARY SCREEN FAN AND DRIVE	667242.0	1	1000225	4014486463033
19	ALTERNATOR DRIVE STARTER	667673.0	1	1002549	4014486494815
20	AGITATOR DRIVE (REAR)	667973.0	1	1000340	4014486465877
21	AGITATOR DRIVE (FRONT)	667974.0	1	1000411	4014486466744

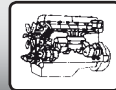

## CLAAS

22	ROTARY SCREEN DRIVE	667561.1	1	1000168	4014486461930
23	THRESHING DRUM VARIATOR DRIVE	661427.0	1	1001228	4014486497847
24	THRESHING CYLINDER	667934.0	1	1001645	4014486485974
25	FAN DRIVE - 1ST STAGE	667957.0	1	1000320	4014486465396
26	FAN INTERMEDIATE DRIVE	667457.0	1	1001079	4014486498233
27	THRESHING DRUM VARIATOR DRIVE	667251.0	1	1003601	4014486485219
	THRESHING DRUM VARIATOR DRIVE	667251.1	1	1003601	4014486485219
	CUTTERBAR DRIVE	667454.1	2	1002870	4014486472981
	STRAW CHOPPER DRIVE - 2ND STAGE	667683.1	1	1000738	4014486471335
	CUTTERBAR DRIVE	667947.1	1	1004537	4014486720853
	STRAW CHOPPER DRIVE - 1ST STAGE	667981.1	1	1001589	4014486485011

## LEXION 410 II

0	CLEANING, 1ST STAGE	644209.2	1	1004843	4014486715668
0	DRUM VARIATOR 2ND STAGE	667248.2	1	1001317	4014486497908
0	CUTTERBAR DRIVE, 2ND STAGE WITH VARIABLE SPEED DRIVE	667551.0	2	1000867	4014486473056
0	CHOPPER DRIVE 1ST STAGE	667958.2	1	1003598	4014486485073
2	CUTTERBAR DRIVE, 1ST STAGE	667255.0	1	1003357	4014486488951
2	CUTTERBAR DRIVE, 1ST STAGE	667255.1	1	1003357	4014486488951
3	THRESHING MECHANISM DRIVE	352371.0	1	1001982	4014486491012
3	THRESHING MECHANISM DRIVE	352371.1	1	1001982	4014486491012
4	GRAIN TANK UNLOADING	667250.0	1	1001586	4014486484960
5	CHOPPER DRIVE 1ST STAGE	667958.3	1	1001593	4014486485080
6	SIEVE PAN, 2ND STAGE	667252.0	1	1003602	4014486485349
7	CHOPPER DRIVE 2ND STAGE	667683.1	1	1000738	4014486471335
8	CHOPPER DRIVE 3RD STAGE RIGID CHOPPER	061701.1	1	1000790	4014486472066
8	CHOPPER DRIVE 3RD STAGE RIGID CHOPPER	061701.2	1	1000790	4014486472066
8	CHOPPER DRIVE 3RD STAGE ADJUSTABLE CHOPPER	667683.1	1	1000738	4014486471335
9	CUTTERBAR DRIVE, 2ND STAGE WITHOUT VARIABLE SPEED DRIVE	667454.0	2	1002870	4014486472981
10	CUTTERBAR DRIVE, 2ND STAGE WITH VARIABLE SPEED DRIVE	667551.1	2	1000867	4014486473056
11	SYNCHRONOUS DRIVE	667249.0	1	1003591	4014486484762
12	CUTTERBAR VARIATOR	667530.1	1	1001163	4014486497441
13	CHAFF SPREADER	758719.0	1	1003405	4014486463309
14	CLEANING, 3RD STAGE	667651.0	1	1001706	4014486486834
15	CLEANING, 1ST STAGE	644209.0	1	1000699	4014486470826
15	CLEANING, 1ST STAGE	644209.1	1	1004843	4014486715668
16	INTENSIVE SEPARATION SYSTEM, SHORT	667973.0	1	1000340	4014486465877
17	INTENSIVE SEPARATION SYSTEM, LONG	667974.0	1	1000411	4014486466744
18	CHOPPER DRIVE 4TH STAGE	667684.0	1	1000595	4014486469264
19	FINGER ROLLER	509035.0	1	1000430	4014486466973
19	FINGER ROLLER	509035.1	1	1000430	4014486466973
22	LEXION 410	661427.0	1	1001228	4014486497847
23	LEXION 410	644902.0	1	1001639	4014486485905
25	LEXION 410	667957.0	1	1000320	4014486465396
26	LEXION 410	644843.0	1	1002286	4014486479690
27	FAN VARIATOR	667457.0	1	1001079	4014486498233
28	PRE - DRUM DRIVE	667251.1	1	1003601	4014486485219
29	HYDRAULIC REEL DRIVE	829094.0	1	1000245	4014486463712
30	STRAW WALKER DRIVE	667477.0	1	1000387	4014486466508
31	STRAW SPREADER	539443.0	1	No AP	
32	DRUM VARIATOR 2ND STAGE	667248.0	1	1001317	4014486497908
33	RADIATOR SCREEN 2ND STAGE	545689.0	1	1003332	4014486461886
34	ENGINE 3126 B	796475.0	1	1003214	4014486482355
35	FAN DRIVE	796450.0	1	1003969	4014486480610
	DRUM VARIATOR 2ND STAGE	667248.1	1	1001317	4014486497908

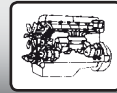
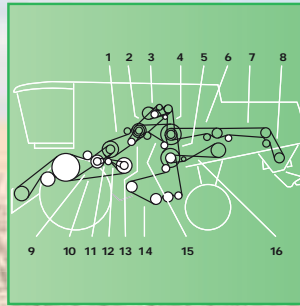
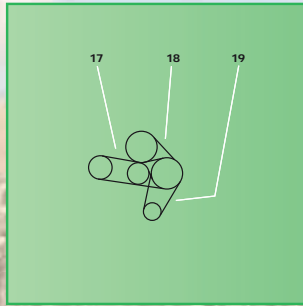
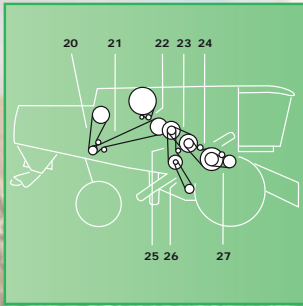

## CLAAS

	CUTTERBAR DRIVE, 2ND STAGE WITHOUT VARIABLE SPEED DRIVE	667454.1	2	1002870	4014486472981
	CUTTERBAR DRIVE, 2ND STAGE WITH VARIABLE SPEED DRIVE	667551.2	2	1000867	4014486473056
	CHOPPER DRIVE 1ST STAGE	667958.1	1	1003598	4014486485073

### LEXION 415

0	SIEVE PAN DRIVE - 1ST STAGE	644209.2	1	1004843	4014486715668
0	THRESHING DRUM VARIATOR DRIVE	667248.2	1	1001317	4014486497908
0	ROTARY SCREEN DRIVE	667456.0	1	1002554	4014486494914
0	STRAW CHOPPER DRIVE - 1ST STAGE	667981.0	1	1001589	4014486485011
0	KNIFE DRIVE	742025.0	1	1000650	4014486470123
1	CLUTCH FOR CUTTERBAR DRIVE	667255.0	1	1003357	4014486488951
1	CLUTCH FOR CUTTERBAR DRIVE	667255.1	1	1003357	4014486488951
2	THRESHING MECHANICAL DRIVE	667680.0	1	1003353	4014486490978
3	DISCHARGE DRIVE GRAIN TANK	667681.0	1	1001583	4014486484908
4	STRAW CHOPPER DRIVE - 1ST STAGE	667981.2	1	1001588	4014486484991
5	SIEVE PAN DRIVE - 2ND STAGE	667252.0	1	1003602	4014486485349
7	STRAW CHOPPER DRIVE - 2ND STAGE	667683.0	1	1000738	4014486471335
8	STRAW CHOPPER DRIVE - 4TH STAGE	667684.0	1	1000595	4014486469264
9	CUTTERBAR DRIVE WITHOUT VARIATOR DRIVE	667454.0	2	1002870	4014486472981
10	CUTTERBAR DRIVE WITHOUT VARIATOR DRIVE	667551.0	2	1000867	4014486473056
10	CUTTERBAR DRIVE WITHOUT VARIATOR DRIVE	667551.2	2	1000867	4014486473056
11	IMPELLER DRUM DRIVE	667249.0	1	1003591	4014486484762
12	CUTTERBAR DRIVE WITH VARIABLE SPEED DRIVE	667530.0	1	1001163	4014486497441
13	HYDRAULIC PUMP DRIVE	758719.0	1	1003405	4014486463309
14	SIEVE PAN DRIVE 2RD STAGE	667651.0	1	1001706	4014486486834
15	SIEVE PAN DRIVE - 1ST STAGE	644209.0	1	1000699	4014486470826
15	SIEVE PAN DRIVE - 1ST STAGE	644209.1	1	1004843	4014486715668
16	STRAW WALKER DRIVE	667477.0	1	1000387	4014486466508
17	COMPRESSOR DRIVE	667560.0	1	1002597	4014486496024
17	COMPRESSOR DRIVE	667560.1	1	1002597	4014486496024
18	ROTARY SCREEN FAN AND DRIVE	667242.0	1	1000225	4014486463033
19	ALTERNATOR DRIVE STARTER	667673.0	1	1002549	4014486494815
20	AGITATOR DRIVE (REAR)	667973.0	1	1000340	4014486465877
21	AGITATOR DRIVE (FRONT)	667974.0	1	1000411	4014486466744
22	ROTARY SCREEN DRIVE	667561.1	1	1000168	4014486461930
23	THRESHING DRUM VARIATOR DRIVE	667248.0	1	1001317	4014486497908
24	THRESHING DRUM VARIATOR DRIVE	667458.0	1	1003642	4014486489101
25	FAN DRIVE - 1ST STAGE	742026.0	1	1000328	4014486465587
26	FAN DRIVE - 1ST STAGE	667457.0	1	1001079	4014486498233
27	SPEED REDUCING GEAR BOX	667251.0	1	1003601	4014486485219
	THRESHING DRUM VARIATOR DRIVE	667248.1	1	1001317	4014486497908
	SPEED REDUCING GEAR BOX	667251.1	1	1003601	4014486485219
	CUTTERBAR DRIVE WITHOUT VARIATOR DRIVE	667454.1	2	1002870	4014486472981
	CUTTERBAR DRIVE WITH VARIABLE SPEED DRIVE	667530.1	1	1001163	4014486497441
	CUTTERBAR DRIVE WITHOUT VARIATOR DRIVE	667551.1	2	1000867	4014486473056
	STRAW CHOPPER DRIVE - 2ND STAGE	667683.1	1	1000738	4014486471335
	STRAW CHOPPER DRIVE - 1ST STAGE	667981.1	1	1001589	4014486485011
	FAN DRIVE - 1ST STAGE	742026.1	1	1003800	4014486518566

### LEXION 420 MONTANA

0	DRUM DRIVE	176442.0	1	1003641	4014486489033
0	DRUM DRIVE	176442.1	1	1003641	4014486489033
0	THRESHING MECHANISM DRIVE	352371.1	1	1001982	4014486491012
0	FINGER ROLLER	509035.1	1	1000430	4014486466973
0	STRAW SPREADER	539443.0	1	No AP	

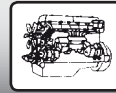
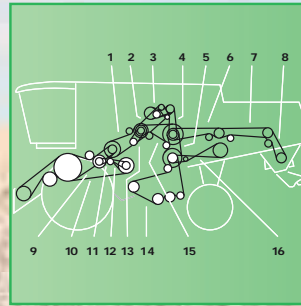
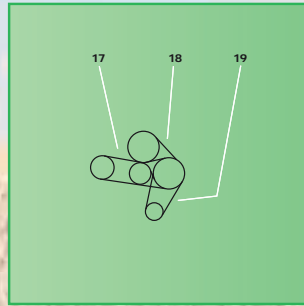
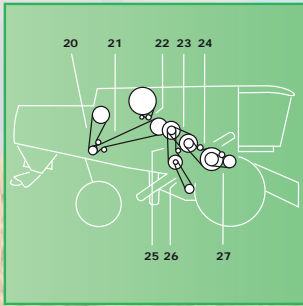

## CLAAS

0	RADIATOR SCREEN 2ND STAGE	545689.0	1	1003332	4014486461886
0	CLEANING, 1ST STAGE	644209.2	1	1004843	4014486715668
0	SUCTION FAN	644781.0	1	1000123	4014486461350
0	DRUM VARIATOR	667248.2	1	1001317	4014486497908
0	DRUM VARIATOR 2ND STAGE	667248.2	1	1001317	4014486497908
0	GRAIN TANK UNLOADING	667250.0	1	1001586	4014486484960
0	CUTTERBAR DRIVE, 3RD STAGE WITH VARIABLE SPEED	667551.0	2	1000867	4014486473056
0	CHOPPER DRIVE, 1ST STAGE	667958.2	1	1003598	4014486485073
0	CHOPPER DRIVE, 1ST STAGE	667958.3	1	1001593	4014486485080
0	FAN DRIVE	796450.0	1	1003969	4014486480610
0	ENGINE 3126 B	796475.0	1	1003214	4014486482355
0	HYDRAULIC REEL DRIVE	829094.0	1	1000245	4014486463712
1	CUTTERBAR DRIVE, 1ST STAGE	667255.0	1	1003357	4014486488951
1	CUTTERBAR DRIVE, 1ST STAGE	667255.1	1	1003357	4014486488951
5	SIEVE PAN, 2ND STAGE	667252.0	1	1003602	4014486485349
7	CHOPPER DRIVE 2ND STAGE	667683.1	1	1000738	4014486471335
7	CHOPPER DRIVE 3RD STAGE ADJUSTABLE CHOPPER	667683.1	1	1000738	4014486471335
8	CHOPPER DRIVE 4TH STAGE	667684.0	1	1000595	4014486469264
9	CUTTERBAR DRIVE, 2ND STAGE WITHOUT VARIABLE SPEED	667454.0	2	1002870	4014486472981
10	CUTTERBAR DRIVE, 3RD STAGE WITH VARIABLE SPEED	667551.1	2	1000867	4014486473056
11	SYNCHRONOUS DRIVE	667249.0	1	1003591	4014486484762
12	CUTTERBAR VARIATOR	667530.0	1	1001163	4014486497441
13	CHAFF SPREADER	758719.0	1	1003405	4014486463309
14	CLEANING, 3RD STAGE	667651.0	1	1001706	4014486486834
15	CLEANING, 1ST STAGE	644209.0	1	1000699	4014486470826
15	CLEANING, 1ST STAGE	644209.1	1	1004843	4014486715668
16	STRAW WALKER DRIVE	667477.0	1	1000387	4014486466508
20	INTENSIVE SEPARATION SYSTEM, SHORT	667973.0	1	1000340	4014486465877
21	INTENSIVE SEPARATION SYSTEM, LONG	667974.0	1	1000411	4014486466744
23	DRUM VARIATOR	667248.0	1	1001317	4014486497908
23	DRUM VARIATOR 2ND STAGE	667248.0	1	1001317	4014486497908
25	FAN DRIVE	742026.0	1	1000328	4014486465587
26	FAN VARIATOR	667457.0	1	1001079	4014486498233
27	PRE - DRUM DRIVE	667251.1	1	1003601	4014486485219
	DRUM VARIATOR	667248.1	1	1001317	4014486497908
	DRUM VARIATOR 2ND STAGE	667248.1	1	1001317	4014486497908
	CUTTERBAR DRIVE, 2ND STAGE WITHOUT VARIABLE SPEED	667454.1	2	1002870	4014486472981
	CUTTERBAR VARIATOR	667530.1	1	1001163	4014486497441
	CUTTERBAR DRIVE, 3RD STAGE WITH VARIABLE SPEED	667551.2	2	1000867	4014486473056
	CHOPPER DRIVE, 1ST STAGE	667958.1	1	1003598	4014486485073
	FAN DRIVE	742026.1	1	1003800	4014486518566

## LEXION 430

0	SIEVE PAN DRIVE - 1ST STAGE	644209.2	1	1004843	4014486715668
0	THRESHING DRUM VARIATOR DRIVE	667248.2	1	1001317	4014486497908
0	ROTARY SCREEN DRIVE	667456.0	1	1002554	4014486494914
0	STRAW CHOPPER DRIVE - 1ST STAGE	667981.0	1	1001589	4014486485011
0	KNIFE DRIVE	742025.0	1	1000650	4014486470123
1	CLUTCH FOR CUTTERBAR DRIVE	667255.0	1	1003357	4014486488951
1	CLUTCH FOR CUTTERBAR DRIVE	667255.1	1	1003357	4014486488951
2	THRESHING MECHANICAL DRIVE	667680.0	1	1003353	4014486490978
3	DISCHARGE DRIVE GRAIN TANK	667681.0	1	1001583	4014486484908
4	STRAW CHOPPER DRIVE - 1ST STAGE	667981.2	1	1001588	4014486484991
5	SIEVE PAN DRIVE - 2ND STAGE	667252.0	1	1003602	4014486485349
7	STRAW CHOPPER DRIVE - 2ND STAGE	667683.0	1	1000738	4014486471335





## CLAAS

8	STRAW CHOPPER DRIVE - 4TH STAGE	667684.0	1	1000595	4014486469264
9	CUTTERBAR DRIVE WITHOUT VARIATOR DRIVE	667454.0	2	1002870	4014486472981
10	CUTTERBAR DRIVE WITHOUT VARIATOR DRIVE	667551.0	2	1000867	4014486473056
10	CUTTERBAR DRIVE WITHOUT VARIATOR DRIVE	667551.2	2	1000867	4014486473056
11	IMPELLER DRUM DRIVE	667249.0	1	1003591	4014486484762
12	CUTTERBAR DRIVE WITH VARIABLE SPEED DRIVE	667530.0	1	1001163	4014486497441
13	HYDRAULIC PUMP DRIVE	758719.0	1	1003405	4014486463309
14	SIEVE PAN DRIVE 2RD STAGE	667651.0	1	1001706	4014486486834
15	SIEVE PAN DRIVE - 1ST STAGE	644209.0	1	1000699	4014486470826
15	SIEVE PAN DRIVE - 1ST STAGE	644209.1	1	1004843	4014486715668
16	STRAW WALKER DRIVE	667477.0	1	1000387	4014486466508
17	COMPRESSOR DRIVE	667560.0	1	1002597	4014486496024
17	COMPRESSOR DRIVE	667560.1	1	1002597	4014486496024
18	ROTARY SCREEN FAN AND DRIVE	667242.0	1	1000225	4014486463033
19	ALTERNATOR DRIVE STARTER	667673.0	1	1002549	4014486494815
20	AGITATOR DRIVE (REAR)	667973.0	1	1000340	4014486465877
21	AGITATOR DRIVE (FRONT)	667974.0	1	1000411	4014486466744
22	ROTARY SCREEN DRIVE	667561.1	1	1000168	4014486461930
23	THRESHING DRUM VARIATOR DRIVE	667248.0	1	1001317	4014486497908
24	THRESHING DRUM VARIATOR DRIVE	667458.0	1	1003642	4014486489101
25	FAN DRIVE - 1ST STAGE	742026.0	1	1000328	4014486465587
26	FAN DRIVE - 1ST STAGE	667457.0	1	1001079	4014486498233
27	SPEED REDUCING GEAR BOX	667251.0	1	1003601	4014486485219
	THRESHING DRUM VARIATOR DRIVE	667248.1	1	1001317	4014486497908
	SPEED REDUCING GEAR BOX	667251.1	1	1003601	4014486485219
	CUTTERBAR DRIVE WITHOUT VARIATOR DRIVE	667454.1	2	1002870	4014486472981
	CUTTERBAR DRIVE WITH VARIABLE SPEED DRIVE	667530.1	1	1001163	4014486497441
	CUTTERBAR DRIVE WITHOUT VARIATOR DRIVE	667551.1	2	1000867	4014486473056
	STRAW CHOPPER DRIVE - 2ND STAGE	667683.1	1	1000738	4014486471335
	STRAW CHOPPER DRIVE - 1ST STAGE	667981.1	1	1001589	4014486485011
	FAN DRIVE - 1ST STAGE	742026.1	1	1003800	4014486518566

## LEXION 430 II

0	CHOPPER DRIVE 3RD STAGE RIGID CHOPPER	061701.1	1	1000790	4014486472066
0	CHOPPER DRIVE 3RD STAGE RIGID CHOPPER	061701.2	1	1000790	4014486472066
0	DRUM DRIVE	176442.0	1	1003641	4014486489033
0	DRUM DRIVE	176442.1	1	1003641	4014486489033
0	FINGER ROLLER	509035.1	1	1000430	4014486466973
0	STRAW SPREADER	539443.0	1	No AP	
0	RADIATOR SCREEN 2ND STAGE	545689.0	1	1003332	4014486461886
0	CLEANING, 1ST STAGE	644209.2	1	1004843	4014486715668
0	SUCTION BLOWER LEXION 430, 420	644781.0	1	1000123	4014486461350
0	DRUM VARIATOR	667248.2	1	1001317	4014486497908
0	DRUM VARIATOR 2ND STAGE	667248.2	1	1001317	4014486497908
0	CUTTERBAR DRIVE, 2ND STAGE WITH VARIABLE SPEED DRIVE	667551.0	2	1000867	4014486473056
0	CHOPPER DRIVE 1ST STAGE	667958.2	1	1003598	4014486485073
0	FAN DRIVE	796450.0	1	1003969	4014486480610
0	ENGINE 3126 B	796475.0	1	1003214	4014486482355
0	HYDRAULIC REEL DRIVE	829094.0	1	1000245	4014486463712
1	CUTTERBAR DRIVE, 1ST STAGE	667255.0	1	1003357	4014486488951
1	CUTTERBAR DRIVE, 1ST STAGE	667255.1	1	1003357	4014486488951
2	THRESHING MECHANISM DRIVE	352371.1	1	1001982	4014486491012
3	GRAIN TANK UNLOADING	667250.0	1	1001586	4014486484960
4	CHOPPER DRIVE 1ST STAGE	667958.3	1	1001593	4014486485080
5	SIEVE PAN, 2ND STAGE	667252.0	1	1003602	4014486485349



## CLAAS

6	CHOPPER DRIVE 2ND STAGE	667683.1	1	1000738	4014486471335
7	CHOPPER DRIVE 3RD STAGE ADJUSTABLE CHOPPER	667683.1	1	1000738	4014486471335
8	CHOPPER DRIVE 4TH STAGE	667684.0	1	1000595	4014486469264
9	CUTTERBAR DRIVE, 2ND STAGE WITHOUT VARIABLE SPEED DRIVE	667454.0	2	1002870	4014486472981
10	CUTTERBAR DRIVE, 2ND STAGE WITH VARIABLE SPEED DRIVE	667551.1	2	1000867	4014486473056
11	SYNCHRONOUS DRIVE	667249.0	1	1003591	4014486484762
12	CUTTERBAR VARIATOR	667530.1	1	1001163	4014486497441
13	CHAFF SPREADER	758719.0	1	1003405	4014486463309
14	CLEANING, 3RD STAGE	667651.0	1	1001706	4014486486834
15	CLEANING, 1ST STAGE	644209.0	1	1000699	4014486470826
15	CLEANING, 1ST STAGE	644209.1	1	1004843	4014486715668
16	STRAW WALKER DRIVE	667477.0	1	1000387	4014486466508
20	INTENSIVE SEPARATION SYSTEM, SHORT	667973.0	1	1000340	4014486465877
21	INTENSIVE SEPARATION SYSTEM, LONG	667974.0	1	1000411	4014486466744
23	DRUM VARIATOR	667248.0	1	1001317	4014486497908
23	DRUM VARIATOR 2ND STAGE	667248.0	1	1001317	4014486497908
25	FAN DRIVE	742026.0	1	1000328	4014486465587
26	FAN VARIATOR	667457.0	1	1001079	4014486498233
27	PRE - DRUM DRIVE	667251.1	1	1003601	4014486485219
	DRUM VARIATOR	667248.1	1	1001317	4014486497908
	DRUM VARIATOR 2ND STAGE	667248.1	1	1001317	4014486497908
	CUTTERBAR DRIVE, 2ND STAGE WITHOUT VARIABLE SPEED DRIVE	667454.1	2	1002870	4014486472981
	CUTTERBAR DRIVE, 2ND STAGE WITH VARIABLE SPEED DRIVE	667551.2	2	1000867	4014486473056
	CHOPPER DRIVE 1ST STAGE	667958.1	1	1003598	4014486485073
	FAN DRIVE	742026.1	1	1003800	4014486518566

## LEXION 430 MONTANA

0	DRUM DRIVE	176442.0	1	1003641	4014486489033
0	DRUM DRIVE	176442.1	1	1003641	4014486489033
0	FINGER ROLLER	509035.1	1	1000430	4014486466973
0	STRAW SPREADER	539443.0	1	No AP	
0	RADIATOR SCREEN 2ND STAGE	545689.0	1	1003332	4014486461886
0	CLEANING, 1ST STAGE	644209.2	1	1004843	4014486715668
0	SUCTION FAN	644781.0	1	1000123	4014486461350
0	DRUM VARIATOR	667248.2	1	1001317	4014486497908
0	DRUM VARIATOR 2ND STAGE	667248.2	1	1001317	4014486497908
0	CUTTERBAR DRIVE, 3RD STAGE WITH VARIABLE SPEED	667551.0	2	1000867	4014486473056
0	CHOPPER DRIVE, 1ST STAGE	667958.2	1	1003598	4014486485073
0	FAN DRIVE	742026.0	1	1000328	4014486465587
0	FAN DRIVE	796450.0	1	1003969	4014486480610
0	ENGINE 3126 B	796475.0	1	1003214	4014486482355
0	HYDRAULIC REEL DRIVE	829094.0	1	1000245	4014486463712
1	CUTTERBAR DRIVE, 1ST STAGE	667255.0	1	1003357	4014486488951
1	CUTTERBAR DRIVE, 1ST STAGE	667255.1	1	1003357	4014486488951
2	THRESHING MECHANISM DRIVE	352371.1	1	1001982	4014486491012
3	GRAIN TANK UNLOADING	667250.0	1	1001586	4014486484960
4	CHOPPER DRIVE, 1ST STAGE	667958.3	1	1001593	4014486485080
5	SIEVE PAN, 2ND STAGE	667252.0	1	1003602	4014486485349
6	CHOPPER DRIVE 2ND STAGE	667683.1	1	1000738	4014486471335
7	CHOPPER DRIVE 3RD STAGE ADJUSTABLE CHOPPER	667683.1	1	1000738	4014486471335
8	CHOPPER DRIVE 4TH STAGE	667684.0	1	1000595	4014486469264
9	CUTTERBAR DRIVE, 2ND STAGE WITHOUT VARIABLE SPEED	667454.0	2	1002870	4014486472981
10	CUTTERBAR DRIVE, 3RD STAGE WITH VARIABLE SPEED	667551.1	2	1000867	4014486473056
11	SYNCHRONOUS DRIVE	667249.0	1	1003591	4014486484762
12	CUTTERBAR VARIATOR	667530.0	1	1001163	4014486497441

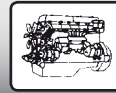
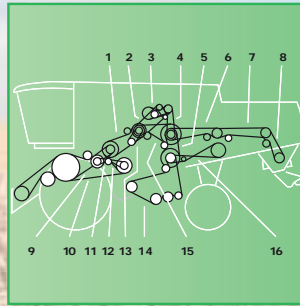
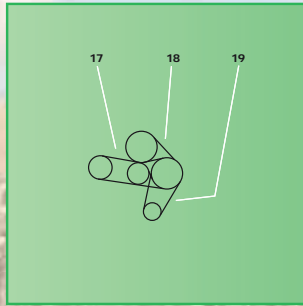
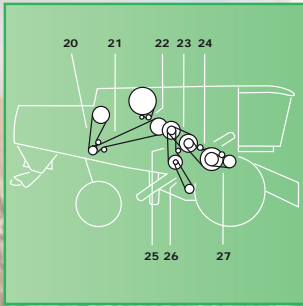

## CLAAS

13	CHAFF SPREADER	758719.0	1	1003405	4014486463309
14	CLEANING, 3RD STAGE	667651.0	1	1001706	4014486486834
15	CLEANING, 1ST STAGE	644209.0	1	1000699	4014486470826
15	CLEANING, 1ST STAGE	644209.1	1	1004843	4014486715668
16	STRAW WALKER DRIVE	667477.0	1	1000387	4014486466508
20	INTENSIVE SEPARATION SYSTEM, SHORT	667973.0	1	1000340	4014486465877
21	INTENSIVE SEPARATION SYSTEM, LONG	667974.0	1	1000411	4014486466744
23	DRUM VARIATOR	667248.0	1	1001317	4014486497908
23	DRUM VARIATOR 2ND STAGE	667248.0	1	1001317	4014486497908
26	FAN VARIATOR	667457.0	1	1001079	4014486498233
27	PRE - DRUM DRIVE	667251.1	1	1003601	4014486485219
	DRUM VARIATOR	667248.1	1	1001317	4014486497908
	DRUM VARIATOR 2ND STAGE	667248.1	1	1001317	4014486497908
	CUTTERBAR DRIVE, 2ND STAGE WITHOUT VARIABLE SPEED	667454.1	2	1002870	4014486472981
	CUTTERBAR VARIATOR	667530.1	1	1001163	4014486497441
	CUTTERBAR DRIVE, 3RD STAGE WITH VARIABLE SPEED	667551.2	2	1000867	4014486473056
	CHOPPER DRIVE, 1ST STAGE	667958.1	1	1003598	4014486485073
	FAN DRIVE	742026.1	1	1003800	4014486518566

## LEXION 440

0	SIEVE PAN DRIVE - 1ST STAGE	644209.2	1	1004843	4014486715668
0	THRESHING DRUM VARIATOR DRIVE	667248.2	1	1001317	4014486497908
0	STRAW CHOPPER DRIVE - 1ST STAGE	667958.3	1	1001593	4014486485080
0	KNIFE DRIVE	742025.0	1	1000650	4014486470123
1	CLUTCH FOR CUTTERBAR DRIVE	667255.0	1	1003357	4014486488951
1	CLUTCH FOR CUTTERBAR DRIVE	667255.1	1	1003357	4014486488951
2	THRESHING MECHANISM DRIVE	667453.0	1	1003350	4014486492095
3	DISCHARGE DRIVE GRAIN TANK	667250.0	1	1001586	4014486484960
4	STRAW CHOPPER DRIVE - 1ST STAGE	667958.2	1	1003598	4014486485073
5	SIEVE PAN DRIVE - 2ND STAGE	667252.0	1	1003602	4014486485349
6	STRAW CHOPPER DRIVE - 2ND STAGE	061700.1	1	1003356	4014486486131
7	STRAW CHOPPER DRIVE - 3ND STAGE	061700.1	1	1003356	4014486486131
8	STRAW CHOPPER DRIVE - 4TH STAGE	661093.0	1	1001581	4014486484885
9	CUTTERBAR DRIVE WITHOUT VARIATOR DRIVE	667454.0	2	1002870	4014486472981
10	CUTTERBAR DRIVE WITH VARIABLE SPEED DRIVE	667551.0	2	1000867	4014486473056
10	CUTTERBAR DRIVE WITH VARIABLE SPEED DRIVE	667551.2	2	1000867	4014486473056
11	IMPELLER DRUM DRIVE	667249.0	1	1003591	4014486484762
12	CUTTERBAR DRIVE WITH VARIABLE SPEED DRIVE	667530.0	1	1001163	4014486497441
13	HYDRAULIC PUMP DRIVE	758719.0	1	1003405	4014486463309
14	SIEVE PAN DRIVE 2RD STAGE	667651.0	1	1001706	4014486486834
15	SIEVE PAN DRIVE - 1ST STAGE	644209.0	1	1000699	4014486470826
15	SIEVE PAN DRIVE - 1ST STAGE	644209.1	1	1004843	4014486715668
16	STRAW WALKER DRIVE	667477.0	1	1000387	4014486466508
17	COMPRESSOR DRIVE	667560.0	1	1002597	4014486496024
17	COMPRESSOR DRIVE	667560.1	1	1002597	4014486496024
18	ROTARY SCREEN FAN AND DRIVE	667242.0	1	1000225	4014486463033
19	ROTARY SCREEN DRIVE	667456.0	1	1002554	4014486494914
20	AGITATOR DRIVE (REAR)	667973.0	1	1000340	4014486465877
21	AGITATOR DRIVE (FRONT)	667974.0	1	1000411	4014486466744
22	ROTARY SCREEN DRIVE	667561.1	1	1000168	4014486461930
23	THRESHING DRUM VARIATOR DRIVE	667248.0	1	1001317	4014486497908
24	THRESHING DRUM VARIATOR DRIVE	667458.0	1	1003642	4014486489101
25	FAN DRIVE - 1ST STAGE	742026.0	1	1000328	4014486465587
26	FAN INTERMEDIATE DRIVE	667457.0	1	1001079	4014486498233
27	SPEED REDUCING GEAR BOX	667251.0	1	1003601	4014486485219



## CLAAS

	THRESHING DRUM VARIATOR DRIVE	667248.1	1	1001317	4014486497908
	SPEED REDUCING GEAR BOX	667251.1	1	1003601	4014486485219
	CUTTERBAR DRIVE WITHOUT VARIATOR DRIVE	667454.1	2	1002870	4014486472981
	CUTTERBAR DRIVE WITH VARIABLE SPEED DRIVE	667530.1	1	1001163	4014486497441
	CUTTERBAR DRIVE WITH VARIABLE SPEED DRIVE	667551.1	2	1000867	4014486473056
	STRAW CHOPPER DRIVE - 1ST STAGE	667958.1	1	1003598	4014486485073
	FAN DRIVE - 1ST STAGE	742026.1	1	1003800	4014486518566

### LEXION 440 II

0	DRUM DRIVE	176442.0	1	1003641	4014486489033
0	DRUM DRIVE	176442.1	1	1003641	4014486489033
0	FINGER ROLLER	509035.1	1	1000430	4014486466973
0	RADIATOR SCREEN 2ND STAGE	545689.0	1	1003332	4014486461886
0	NO. 54401896 - 54402245	628888.0	1	1001684	4014486486551
0	CLEANING, 1ST STAGE	644209.2	1	1004843	4014486715668
0	SUCTION FAN	644781.0	1	1000123	4014486461350
0	DRUM VARIATOR	667248.2	1	1001317	4014486497908
0	DRUM VARIATOR 2ND STAGE	667248.2	1	1001317	4014486497908
0	CUTTERBAR DRIVE, 3RD STAGE WITH VARIABLE SPEED DRIVE	667551.0	2	1000867	4014486473056
0	CHOPPER DRIVE 1ST STAGE	667958.2	1	1003598	4014486485073
0	SUCTION BLOWER E - CHANNEL	765985.0	1	1002287	4014486479706
0	FAN DRIVE	796450.0	1	1003969	4014486480610
0	ENGINE C9	796474.0	1	1003217	4014486482454
0	ENGINE 3126 B	796475.0	1	1003214	4014486482355
1	CUTTERBAR DRIVE, 1ST STAGE	667255.0	1	1003357	4014486488951
1	CUTTERBAR DRIVE, 1ST STAGE	667255.1	1	1003357	4014486488951
2	THRESHING MECHANISM DRIVE	667453.0	1	1003350	4014486492095
3	GRAIN TANK UNLOADING	667250.0	1	1001586	4014486484960
4	CHOPPER DRIVE 1ST STAGE	667958.3	1	1001593	4014486485080
5	SIEVE PAN, 2ND STAGE	667252.0	1	1003602	4014486485349
6	CHOPPER DRIVE 2ND STAGE	061700.1	1	1003356	4014486486131
7	CHOPPER DRIVE 3RD STAGE ADJUSTABLE CHOPPER NO. 54401896 - 54402245	061700.1	1	1003356	4014486486131
8	CHOPPER DRIVE 4TH STAGE	661093.0	1	1001581	4014486484885
8	CHOPPER DRIVE 3RD STAGE RIGID CHOPPER FROM NO. 54402246 TO NO. 54401895	749828.0	1	1001681	4014486486513
9	CUTTERBAR DRIVE, 2ND STAGE WITHOUT VARIABLE SPEED DRIVE	667454.0	2	1002870	4014486472981
10	CUTTERBAR DRIVE, 3RD STAGE WITH VARIABLE SPEED DRIVE	667551.1	2	1000867	4014486473056
11	SYNCHRONOUS DRIVE	667249.0	1	1003591	4014486484762
12	CUTTERBAR VARIATOR	667530.1	1	1001163	4014486497441
13	CHAFF SPREADER	758719.0	1	1003405	4014486463309
14	CLEANING, 3RD STAGE	667651.0	1	1001706	4014486486834
15	CLEANING, 1ST STAGE	644209.0	1	1000699	4014486470826
15	CLEANING, 1ST STAGE	644209.1	1	1004843	4014486715668
16	STRAW WALKER DRIVE	667477.0	1	1000387	4014486466508
20	INTENSIVE SEPARATION SYSTEM, SHORT	667973.0	1	1000340	4014486465877
21	INTENSIVE SEPARATION SYSTEM, LONG	667974.0	1	1000411	4014486466744
22	DRUM VARIATOR	667248.0	1	1001317	4014486497908
23	DRUM VARIATOR 2ND STAGE	667248.0	1	1001317	4014486497908
25	FAN DRIVE	742026.0	1	1000328	4014486465587
26	FAN VARIATOR	667457.0	1	1001079	4014486498233
27	PRE - DRUM DRIVE	667251.1	1	1003601	4014486485219
29	HYDRAULIC REEL DRIVE	829094.0	1	1000245	4014486463712
31	STRAW SPREADER	539443.0	1	No AP	
	DRUM VARIATOR	667248.1	1	1001317	4014486497908
	DRUM VARIATOR 2ND STAGE	667248.1	1	1001317	4014486497908
	CUTTERBAR DRIVE, 2ND STAGE WITHOUT VARIABLE SPEED DRIVE	667454.1	2	1002870	4014486472981

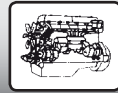

## CLAAS

	CUTTERBAR DRIVE, 3RD STAGE WITH VARIABLE SPEED DRIVE	667551.2	2	1000867	4014486473056
	CHOPPER DRIVE 1ST STAGE	667958.1	1	1003598	4014486485073
	FAN DRIVE	742026.1	1	1003800	4014486518566

### LEXION 450 II MTS

0	CLEANING, 1ST STAGE	644209.2	1	1004843	4014486715668
0	DRUM VARIATOR	667248.2	1	1001317	4014486497908
0	DRUM VARIATOR 2ND STAGE	667248.2	1	1001317	4014486497908
0	CUTTERBAR DRIVE, 3RD STAGE WITH VARIABLE SPEED DRIVE	667551.0	2	1000867	4014486473056
0	CHOPPER DRIVE 1ST STAGE	667958.2	1	1003598	4014486485073
2	CUTTERBAR DRIVE, 1ST STAGE	667255.0	1	1003357	4014486488951
2	CUTTERBAR DRIVE, 1ST STAGE	667255.1	1	1003357	4014486488951
3	THRESHING MECHANISM DRIVE	352403.0	1	1001253	4014486492101
4	GRAIN TANK UNLOADING	667250.0	1	1001586	4014486484960
5	CHOPPER DRIVE 1ST STAGE	667958.3	1	1001593	4014486485080
6	SIEVE PAN 2ND STAGE	667252.0	1	1003602	4014486485349
7	CHOPPER DRIVE 2ND STAGE	061700.1	1	1003356	4014486486131
8	CHOPPER DRIVE 3RD STAGE ADJUSTABLE CHOPPER	061700.1	1	1003356	4014486486131
8	NO. 54700041 - 54700049	628888.0	1	1001684	4014486486551
8	CHOPPER DRIVE 3RD STAGE RIGID CHOPPER FROM NO. 54700050	749828.0	1	1001681	4014486486513
8	TO NO. 54700040	749828.0	1	1001681	4014486486513
9	CUTTERBAR DRIVE, 2ND STAGE WITHOUT VARIABLE SPEED DRIVE	667454.0	2	1002870	4014486472981
10	CUTTERBAR DRIVE, 3RD STAGE WITH VARIABLE SPEED DRIVE	667551.1	2	1000867	4014486473056
11	SYNCHRONOUS DRIVE	667249.0	1	1003591	4014486484762
12	CUTTERBAR VARIATOR	667530.1	1	1001163	4014486497441
13	CHAFF SPREADER	758719.0	1	1003405	4014486463309
14	CLEANING, 3RD STAGE	667651.0	1	1001706	4014486486834
15	CLEANING, 1ST STAGE	644209.0	1	1000699	4014486470826
15	CLEANING, 1ST STAGE	644209.1	1	1004843	4014486715668
18	CHOPPER DRIVE 4TH STAGE	661093.0	1	1001581	4014486484885
19	FINGER ROLLER	509035.1	1	1000430	4014486466973
22	DRUM VARIATOR	667248.0	1	1001317	4014486497908
23	DRUM DRIVE	176442.0	1	1003641	4014486489033
23	DRUM DRIVE	176442.1	1	1003641	4014486489033
25	FAN DRIVE	742026.0	1	1000328	4014486465587
26	SUCTION FAN	644781.0	1	1000123	4014486461350
27	FAN VARIATOR	667457.0	1	1001079	4014486498233
28	PRE - DRUM DRIVE	667251.1	1	1003601	4014486485219
29	HYDRAULIC REEL DRIVE	829094.0	1	1000245	4014486463712
30	STRAW WALKER DRIVE	667477.0	1	1000387	4014486466508
31	STRAW SPREADER	539443.0	1	No AP	
32	DRUM VARIATOR 2ND STAGE	667248.0	1	1001317	4014486497908
33	RADIATOR SCREEN 2ND STAGE	545689.0	1	1003332	4014486461886
34	ENGINE C9	796474.0	1	1003217	4014486482454
35	FAN DRIVE	796450.0	1	1003969	4014486480610
36	SUCTION BLOWER E - CHANNEL	765985.0	1	1002287	4014486479706
	DRUM VARIATOR	667248.1	1	1001317	4014486497908
	DRUM VARIATOR 2ND STAGE	667248.1	1	1001317	4014486497908
	CUTTERBAR DRIVE, 2ND STAGE WITHOUT VARIABLE SPEED DRIVE	667454.1	2	1002870	4014486472981
	CUTTERBAR DRIVE, 3RD STAGE WITH VARIABLE SPEED DRIVE	667551.2	2	1000867	4014486473056
	CHOPPER DRIVE 1ST STAGE	667958.1	1	1003598	4014486485073
	FAN DRIVE	742026.1	1	1003800	4014486518566

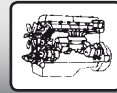
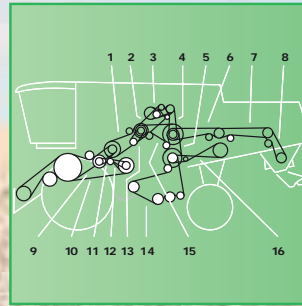
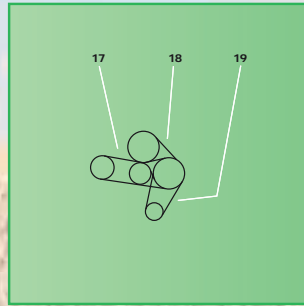
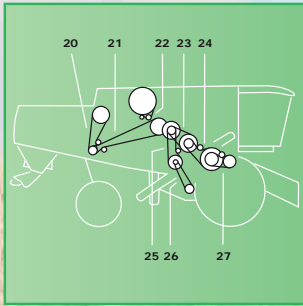

# CLAAS

## LEXION 450 TERRA

0	1ST STAGE CLEANING	644209.2	1	1004843	4014486715668
0	DRUM VARIABLE SPEED DRIVE	667248.2	1	1001317	4014486497908
0	3RD STAGE CUTTERBAR WITH VARIABLE SPEED	667551.0	2	1000867	4014486473056
0	1ST STAGE CHOPPER	667958.2	1	1003598	4014486485073
1	1ST STAGE CUTTERBAR	667255.0	1	1003357	4014486488951
1	1ST STAGE CUTTERBAR	667255.1	1	1003357	4014486488951
2	THRESHING MECHANISM	667453.0	1	1003350	4014486492095
3	GRAIN TANK UNLOADING	667250.0	1	1001586	4014486484960
4	1ST STAGE CHOPPER	667958.3	1	1001593	4014486485080
5	2ND STAGE CLEANING	667252.0	1	1003602	4014486485349
6	2ND STAGE CHOPPER	061700.1	1	1003356	4014486486131
7	3RD STAGE CHOPPER	061700.1	1	1003356	4014486486131
8	4TH STAGE CHOPPER	661093.0	1	1001581	4014486484885
9	2ND STAGE CUTTERBAR WITHOUT VARIABLE SPEED	667454.0	2	1002870	4014486472981
10	3RD STAGE CUTTERBAR WITH VARIABLE SPEED	667551.1	2	1000867	4014486473056
11	IMPELLER DRUM	667249.0	1	1003591	4014486484762
12	CUTTERBAR VARIABLE SPEED	667530.0	1	1001163	4014486497441
13	HYDRAULIC PUMP	758719.0	1	1003405	4014486463309
14	3RD STAGE CLEANING	667651.0	1	1001706	4014486486834
15	1ST STAGE CLEANING	644209.0	1	1000699	4014486470826
15	1ST STAGE CLEANING	644209.1	1	1004843	4014486715668
16	STRAW WALKER	667477.0	1	1000387	4014486466508
17	COMPRESSOR	667560.0	1	1002597	4014486496024
17	COMPRESSOR	667560.1	1	1002597	4014486496024
18	MOTOR FAN	667242.0	1	1000225	4014486463033
19	1ST STAGE RADIATOR SCREEN	667456.0	1	1002554	4014486494914
20	REAR FEED RAKE	667973.0	1	1000340	4014486465877
21	FRONT FEED RAKE	667974.0	1	1000411	4014486466744
22	2ND STAGE RADIATOR SCREEN	667561.1	1	1000168	4014486461930
24	DRUM VARIABLE SPEED DRIVE	667248.0	1	1001317	4014486497908
24	THRESHING DRUM FROM NO. 45800017	176442.0	1	1003641	4014486489033
24	THRESHING DRUM FROM NO. 45800017	176442.1	1	1003641	4014486489033
24	THRESHING DRUM AT DISC D 593 MM OPTIONAL	667255.0	1	1003357	4014486488951
24	THRESHING DRUM AT DISC D 593 MM OPTIONAL	667255.1	1	1003357	4014486488951
24	THRESHING DRUM TO NO. 45700016	667458.0	1	1003642	4014486489101
25	1ST STAGE BLOWER	742026.0	1	1000328	4014486465587
26	FAN VARIABLE SPEED DRIVE	667457.0	1	1001079	4014486498233
27	ACCELERATOR	667251.1	1	1003601	4014486485219
28	SUCTION FAN	644781.0	1	1000123	4014486461350
	DRUM VARIABLE SPEED DRIVE	667248.1	1	1001317	4014486497908
	2ND STAGE CUTTERBAR WITHOUT VARIABLE SPEED	667454.1	2	1002870	4014486472981
	CUTTERBAR VARIABLE SPEED	667530.1	1	1001163	4014486497441
	3RD STAGE CUTTERBAR WITH VARIABLE SPEED	667551.2	2	1000867	4014486473056
	1ST STAGE CHOPPER	667958.1	1	1003598	4014486485073
	1ST STAGE BLOWER	742026.1	1	1003800	4014486518566

## LEXION 460

0	SIEVE PAN DRIVE - 1ST STAGE	644209.2	1	1004843	4014486715668
0	THRESHING DRUM VARIATOR DRIVE	667248.2	1	1001317	4014486497908
0	STRAW CHOPPER DRIVE - 1ST STAGE	667958.3	1	1001593	4014486485080
0	KNIFE DRIVE	742025.0	1	1000650	4014486470123
1	CLUTCH FOR CUTTERBAR DRIVE	667255.0	1	1003357	4014486488951
1	CLUTCH FOR CUTTERBAR DRIVE	667255.1	1	1003357	4014486488951

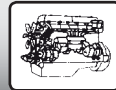

## CLAAS

2	THRESHING MECHANISM DRIVE	667453.0	1	1003350	4014486492095
3	DISCHARGE DRIVE GRAIN TANK	667250.0	1	1001586	4014486484960
4	STRAW CHOPPER DRIVE - 1ST STAGE	667958.2	1	1003598	4014486485073
5	SIEVE PAN DRIVE - 2ND STAGE	667252.0	1	1003602	4014486485349
6	STRAW CHOPPER DRIVE - 2ND STAGE	061700.1	1	1003356	4014486486131
7	STRAW CHOPPER DRIVE - 3ND STAGE	061700.1	1	1003356	4014486486131
8	STRAW CHOPPER DRIVE - 4TH STAGE	661093.0	1	1001581	4014486484885
9	CUTTERBAR DRIVE WITHOUT VARIATOR DRIVE	667454.0	2	1002870	4014486472981
10	CUTTERBAR DRIVE WITH VARIABLE SPEED DRIVE	667551.0	2	1000867	4014486473056
10	CUTTERBAR DRIVE WITH VARIABLE SPEED DRIVE	667551.2	2	1000867	4014486473056
11	IMPELLER DRUM DRIVE	667249.0	1	1003591	4014486484762
12	CUTTERBAR DRIVE WITH VARIABLE SPEED DRIVE	667530.0	1	1001163	4014486497441
13	HYDRAULIC PUMP DRIVE	758719.0	1	1003405	4014486463309
14	SIEVE PAN DRIVE 2RD STAGE	667651.0	1	1001706	4014486486834
15	SIEVE PAN DRIVE - 1ST STAGE	644209.0	1	1000699	4014486470826
15	SIEVE PAN DRIVE - 1ST STAGE	644209.1	1	1004843	4014486715668
16	STRAW WALKER DRIVE	667477.0	1	1000387	4014486466508
17	COMPRESSOR DRIVE	667560.0	1	1002597	4014486496024
17	COMPRESSOR DRIVE	667560.1	1	1002597	4014486496024
18	ROTARY SCREEN FAN AND DRIVE	667242.0	1	1000225	4014486463033
19	ROTARY SCREEN DRIVE	667456.0	1	1002554	4014486494914
20	AGITATOR DRIVE (REAR)	667973.0	1	1000340	4014486465877
21	AGITATOR DRIVE (FRONT)	667974.0	1	1000411	4014486466744
22	ROTARY SCREEN DRIVE	667561.1	1	1000168	4014486461930
23	THRESHING DRUM VARIATOR DRIVE	667248.0	1	1001317	4014486497908
24	THRESHING DRUM VARIATOR DRIVE	667458.0	1	1003642	4014486489101
25	FAN DRIVE - 1ST STAGE	742026.0	1	1000328	4014486465587
26	FAN INTERMEDIATE DRIVE	667457.0	1	1001079	4014486498233
27	SPEED REDUCING GEAR BOX	667251.0	1	1003601	4014486485219
	THRESHING DRUM VARIATOR DRIVE	667248.1	1	1001317	4014486497908
	SPEED REDUCING GEAR BOX	667251.1	1	1003601	4014486485219
	CUTTERBAR DRIVE WITHOUT VARIATOR DRIVE	667454.1	2	1002870	4014486472981
	CUTTERBAR DRIVE WITH VARIABLE SPEED DRIVE	667530.1	1	1001163	4014486497441
	CUTTERBAR DRIVE WITH VARIABLE SPEED DRIVE	667551.1	2	1000867	4014486473056
	STRAW CHOPPER DRIVE - 1ST STAGE	667958.1	1	1003598	4014486485073
	FAN DRIVE - 1ST STAGE	742026.1	1	1003800	4014486518566

## LEXION 460 II

0	DRUM DRIVE	176442.0	1	1003641	4014486489033
0	DRUM DRIVE	176442.1	1	1003641	4014486489033
0	THRESHING MECHANISM DRIVE	352403.0	1	1001253	4014486492101
0	FINGER ROLLER	509035.1	1	1000430	4014486466973
0	STRAW SPREADER	539443.0	1	No AP	
0	RADIATOR SCREEN 2ND STAGE	545689.0	1	1003332	4014486461886
0	NO. 54401896 - 54402245	628888.0	1	1001684	4014486486551
0	CLEANING, 1ST STAGE	644209.2	1	1004843	4014486715668
0	SUCTION FAN	644781.0	1	1000123	4014486461350
0	DRUM VARIATOR	667248.2	1	1001317	4014486497908
0	DRUM VARIATOR 2ND STAGE	667248.2	1	1001317	4014486497908
0	CUTTERBAR DRIVE, 3RD STAGE WITH VARIABLE SPEED DRIVE	667551.0	2	1000867	4014486473056
0	CHOPPER DRIVE 1ST STAGE	667958.2	1	1003598	4014486485073
0	CHOPPER DRIVE 3RD STAGE RIGID CHOPPER FROM NO. 54402246	749828.0	1	1001681	4014486486513
0	TO NO. 54401895	749828.0	1	1001681	4014486486513
0	SUCTION BLOWER E - CHANNEL	765985.0	1	1002287	4014486479706
0	FAN DRIVE	796450.0	1	1003969	4014486480610



## CLAAS

0	ENGINE C9	796474.0	1	1003217	4014486482454
0	ENGINE 3126 B	796475.0	1	1003214	4014486482355
0	HYDRAULIC REEL DRIVE	829094.0	1	1000245	4014486463712
1	CUTTERBAR DRIVE, 1ST STAGE	667255.0	1	1003357	4014486488951
1	CUTTERBAR DRIVE, 1ST STAGE	667255.1	1	1003357	4014486488951
3	GRAIN TANK UNLOADING	667250.0	1	1001586	4014486484960
4	CHOPPER DRIVE 1ST STAGE	667958.3	1	1001593	4014486485080
5	SIEVE PAN, 2ND STAGE	667252.0	1	1003602	4014486485349
6	CHOPPER DRIVE 2ND STAGE	061700.1	1	1003356	4014486486131
7	CHOPPER DRIVE 3RD STAGE ADJUSTABLE CHOPPER	061700.1	1	1003356	4014486486131
8	CHOPPER DRIVE 4TH STAGE	661093.0	1	1001581	4014486484885
9	CUTTERBAR DRIVE, 2ND STAGE WITHOUT VARIABLE SPEED DRIVE	667454.0	2	1002870	4014486472981
10	CUTTERBAR DRIVE, 3RD STAGE WITH VARIABLE SPEED DRIVE	667551.1	2	1000867	4014486473056
11	SYNCHRONOUS DRIVE	667249.0	1	1003591	4014486484762
12	CUTTERBAR VARIATOR	667530.1	1	1001163	4014486497441
13	CHAFF SPREADER	758719.0	1	1003405	4014486463309
14	CLEANING, 3RD STAGE	667651.0	1	1001706	4014486486834
15	CLEANING, 1ST STAGE	644209.0	1	1000699	4014486470826
15	CLEANING, 1ST STAGE	644209.1	1	1004843	4014486715668
16	STRAW WALKER DRIVE	667477.0	1	1000387	4014486466508
20	INTENSIVE SEPERATION SYSTEM, SHORT	667973.0	1	1000340	4014486465877
21	INTENSIVE SEPERATION SYSTEM, LONG	667974.0	1	1000411	4014486466744
23	DRUM VARIATOR	667248.0	1	1001317	4014486497908
23	DRUM VARIATOR 2ND STAGE	667248.0	1	1001317	4014486497908
25	FAN DRIVE	742026.0	1	1000328	4014486465587
26	FAN VARIATOR	667457.0	1	1001079	4014486498233
27	PRE - DRUM DRIVE	667251.1	1	1003601	4014486485219
	DRUM VARIATOR	667248.1	1	1001317	4014486497908
	DRUM VARIATOR 2ND STAGE	667248.1	1	1001317	4014486497908
	CUTTERBAR DRIVE, 2ND STAGE WITHOUT VARIABLE SPEED DRIVE	667454.1	2	1002870	4014486472981
	CUTTERBAR DRIVE, 3RD STAGE WITH VARIABLE SPEED DRIVE	667551.2	2	1000867	4014486473056
	CHOPPER DRIVE 1ST STAGE	667958.1	1	1003598	4014486485073
	FAN DRIVE	742026.1	1	1003800	4014486518566

## LEXION 460 II MTS

0	DRUM DRIVE	176442.0	1	1003641	4014486489033
0	DRUM DRIVE	176442.1	1	1003641	4014486489033
0	THRESHING MECHANISM DRIVE	352403.0	1	1001253	4014486492101
0	FINGER ROLLER	509035.1	1	1000430	4014486466973
0	STRAW SPREADER	539443.0	1	No AP	
0	RADIATOR SCREEN 2ND STAGE	545689.0	1	1003332	4014486461886
0	NO. 54700041 - 54700049	628888.0	1	1001684	4014486486551
0	CLEANING, 1ST STAGE	644209.2	1	1004843	4014486715668
0	SUCTION FAN	644781.0	1	1000123	4014486461350
0	DRUM VARIATOR	667248.2	1	1001317	4014486497908
0	DRUM VARIATOR 2ND STAGE	667248.2	1	1001317	4014486497908
0	CUTTERBAR DRIVE, 3RD STAGE WITH VARIABLE SPEED DRIVE	667551.0	2	1000867	4014486473056
0	CUTTERBAR DRIVE, 3RD STAGE WITH VARIABLE SPEED DRIVE	667551.1	2	1000867	4014486473056
0	CHOPPER DRIVE 1ST STAGE	667958.2	1	1003598	4014486485073
0	CHOPPER DRIVE 3RD STAGE RIGID CHOPPER FROM NO. 54700050	749828.0	1	1001681	4014486486513
0	TO NO. 54700040	749828.0	1	1001681	4014486486513
0	SUCTION BLOWER E - CHANNEL	765985.0	1	1002287	4014486479706
0	FAN DRIVE	796450.0	1	1003969	4014486480610
0	ENGINE C9	796474.0	1	1003217	4014486482454
0	HYDRAULIC REEL DRIVE	829094.0	1	1000245	4014486463712





## CLAAS

1	CUTTERBAR DRIVE, 1ST STAGE	667255.0	1	1003357	4014486488951
1	CUTTERBAR DRIVE, 1ST STAGE	667255.1	1	1003357	4014486488951
3	GRAIN TANK UNLOADING	667250.0	1	1001586	4014486484960
4	CHOPPER DRIVE 1ST STAGE	667958.3	1	1001593	4014486485080
5	SIEVE PAN 2ND STAGE	667252.0	1	1003602	4014486485349
6	CHOPPER DRIVE 2ND STAGE	061700.1	1	1003356	4014486486131
7	CHOPPER DRIVE 3RD STAGE ADJUSTABLE CHOPPER	061700.1	1	1003356	4014486486131
8	CHOPPER DRIVE 4TH STAGE	661093.0	1	1001581	4014486484885
9	CUTTERBAR DRIVE, 2ND STAGE WITHOUT VARIABLE SPEED DRIVE	667454.0	2	1002870	4014486472981
11	SYNCHRONOUS DRIVE	667249.0	1	1003591	4014486484762
12	CUTTERBAR VARIATOR	667530.1	1	1001163	4014486497441
13	CHAFF SPREADER	758719.0	1	1003405	4014486463309
14	CLEANING, 3RD STAGE	667651.0	1	1001706	4014486486834
15	CLEANING, 1ST STAGE	644209.0	1	1000699	4014486470826
15	CLEANING, 1ST STAGE	644209.1	1	1004843	4014486715668
16	STRAW WALKER DRIVE	667477.0	1	1000387	4014486466508
23	DRUM VARIATOR	667248.0	1	1001317	4014486497908
23	DRUM VARIATOR 2ND STAGE	667248.0	1	1001317	4014486497908
25	FAN DRIVE	742026.0	1	1000328	4014486465587
26	FAN VARIATOR	667457.0	1	1001079	4014486498233
27	PRE - DRUM DRIVE	667251.1	1	1003601	4014486485219
	DRUM VARIATOR	667248.1	1	1001317	4014486497908
	DRUM VARIATOR 2ND STAGE	667248.1	1	1001317	4014486497908
	CUTTERBAR DRIVE, 2ND STAGE WITHOUT VARIABLE SPEED DRIVE	667454.1	2	1002870	4014486472981
	CUTTERBAR DRIVE, 3RD STAGE WITH VARIABLE SPEED DRIVE	667551.2	2	1000867	4014486473056
	CHOPPER DRIVE 1ST STAGE	667958.1	1	1003598	4014486485073
	FAN DRIVE	742026.1	1	1003800	4014486518566

## LEXION 460 TERRA

0	THRESHING DRUM FROM NO. 45800017	176442.0	1	1003641	4014486489033
0	THRESHING DRUM FROM NO. 45800017	176442.1	1	1003641	4014486489033
0	1ST STAGE CLEANING	644209.2	1	1004843	4014486715668
0	SUCTION FAN	644781.0	1	1000123	4014486461350
0	DRUM VARIABLE SPEED DRIVE	667248.2	1	1001317	4014486497908
0	THRESHING DRUM AT DISC D 593 MM OPTIONAL	667255.0	1	1003357	4014486488951
0	THRESHING DRUM AT DISC D 593 MM OPTIONAL	667255.1	1	1003357	4014486488951
0	3RD STAGE CUTTERBAR WITH VARIABLE SPEED	667551.0	2	1000867	4014486473056
0	1ST STAGE CHOPPER	667958.2	1	1003598	4014486485073
1	1ST STAGE CUTTERBAR	667255.0	1	1003357	4014486488951
1	1ST STAGE CUTTERBAR	667255.1	1	1003357	4014486488951
2	THRESHING MECHANISM	667453.0	1	1003350	4014486492095
3	GRAIN TANK UNLOADING	667250.0	1	1001586	4014486484960
4	1ST STAGE CHOPPER	667958.3	1	1001593	4014486485080
5	2ND STAGE CLEANING	667252.0	1	1003602	4014486485349
6	2ND STAGE CHOPPER	061700.1	1	1003356	4014486486131
7	3RD STAGE CHOPPER	061700.1	1	1003356	4014486486131
8	4TH STAGE CHOPPER	661093.0	1	1001581	4014486484885
9	2ND STAGE CUTTERBAR WITHOUT VARIABLE SPEED	667454.0	2	1002870	4014486472981
10	3RD STAGE CUTTERBAR WITH VARIABLE SPEED	667551.1	2	1000867	4014486473056
11	IMPELLER DRUM	667249.0	1	1003591	4014486484762
12	CUTTERBAR VARIABLE SPEED	667530.0	1	1001163	4014486497441
13	HYDRAULIC PUMP	758719.0	1	1003405	4014486463309
14	3RD STAGE CLEANING	667651.0	1	1001706	4014486486834
15	1ST STAGE CLEANING	644209.0	1	1000699	4014486470826
15	1ST STAGE CLEANING	644209.1	1	1004843	4014486715668



## CLAAS

16	STRAW WALKER	667477.0	1	1000387	4014486466508
17	COMPRESSOR	667560.0	1	1002597	4014486496024
17	COMPRESSOR	667560.1	1	1002597	4014486496024
18	MOTOR FAN	667242.0	1	1000225	4014486463033
19	1ST STAGE RADIATOR SCREEN	667456.0	1	1002554	4014486494914
20	REAR FEED RAKE	667973.0	1	1000340	4014486465877
21	FRONT FEED RAKE	667974.0	1	1000411	4014486466744
22	2ND STAGE RADIATOR SCREEN	667561.1	1	1000168	4014486461930
23	DRUM VARIABLE SPEED DRIVE	667248.0	1	1001317	4014486497908
24	THRESHING DRUM TO NO. 45700016	667458.0	1	1003642	4014486489101
25	1ST STAGE BLOWER	742026.0	1	1000328	4014486465587
26	FAN VARIABLE SPEED DRIVE	667457.0	1	1001079	4014486498233
27	ACCELERATOR	667251.1	1	1003601	4014486485219
	DRUM VARIABLE SPEED DRIVE	667248.1	1	1001317	4014486497908
	2ND STAGE CUTTERBAR WITHOUT VARIABLE SPEED	667454.1	2	1002870	4014486472981
	CUTTERBAR VARIABLE SPEED	667530.1	1	1001163	4014486497441
	3RD STAGE CUTTERBAR WITH VARIABLE SPEED	667551.2	2	1000867	4014486473056
	1ST STAGE CHOPPER	667958.1	1	1003598	4014486485073
	1ST STAGE BLOWER	742026.1	1	1003800	4014486518566

## LEXION 470

0	CLEANING - 1ST STAGE	644209.2	1	1004843	4014486715668
0	DRUM DRIVE VARIABLE SPEED	667248.2	1	1001317	4014486497908
0	HYBRID VARIABLE SPEED DRIVE	667248.2	1	1001317	4014486497908
0	CUTTERBAR DRIVE - 3RD STAGE FOR VARIABLE SPEED DRIVE	667551.0	2	1000867	4014486473056
0	CHOPPER DRIVE - 1ST STAGE	667958.2	1	1003598	4014486485073
2	CUTTERBAR DRIVE - 1ST STAGE	667255.0	1	1003357	4014486488951
2	CUTTERBAR DRIVE - 1ST STAGE	667255.1	1	1003357	4014486488951
3	THRESHING MECHANISM DRIVE	352403.0	1	1001253	4014486492101
4	DISCHARGE DRIVE GRAIN TANK	667250.0	1	1001586	4014486484960
5	CHOPPER DRIVE - 1ST STAGE	667958.3	1	1001593	4014486485080
6	SIEVE PAN DRIVE - 2ND STAGE	667252.0	1	1003602	4014486485349
7	CHOPPER DRIVE - 2ND STAGE	061700.1	1	1003356	4014486486131
8	CHOPPER DRIVE - 3RD STAGE	350463.0	1	1001665	4014486486278
9	CUTTERBAR DRIVE - 2ND STAGE WITHOUT VARIABLE SPEED DRIVE	667454.0	2	1002870	4014486472981
10	CUTTERBAR DRIVE - 3RD STAGE FOR VARIABLE SPEED DRIVE	667551.1	2	1000867	4014486473056
11	SYNCHRONOUS DRIVE	667249.0	1	1003591	4014486484762
12	CUTTERBAR DRIVE WITH VARIABLE SPEED DRIVE	667530.1	1	1001163	4014486497441
13	CHAFF SPREADER DRIVE	758719.0	1	1003405	4014486463309
14	CLEANING - 3RD STAGE	667651.0	1	1001706	4014486486834
15	CLEANING - 1ST STAGE	644209.0	1	1000699	4014486470826
15	CLEANING - 1ST STAGE	644209.1	1	1004843	4014486715668
16	HYBRID DRIVE - 2ND STAGE	629510.0	1	1003634	4014486488623
16	HYBRID DRIVE - 2ND STAGE	629510.1	1	1003634	4014486488623
17	HYBRID DRIVE - 1ST STAGE	749886.1	1	1001928	4014486489972
22	DRUM DRIVE VARIABLE SPEED	667248.0	1	1001317	4014486497908
23	DRUM DRIVE	176442.0	1	1003641	4014486489033
23	DRUM DRIVE	176442.1	1	1003641	4014486489033
25	FAN DRIVE	742026.0	1	1000328	4014486465587
26	SUCTION FAN	644781.0	1	1000123	4014486461350
27	FAN DRIVE VARIABLE SPEED	667457.0	1	1001079	4014486498233
28	PRE-DRUM DRIVE	667251.1	1	1003601	4014486485219
29	HYDRAULIC REEL PUMP DRIVE	829094.0	1	1000245	4014486463712
30	STRAW SPREADER DRIVE	539443.0	1	No AP	
31	HYBRID VARIABLE SPEED DRIVE	667248.0	1	1001317	4014486497908

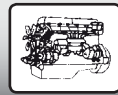

## CLAAS

32	RADIATOR SCREEN 2ND STAGE	545689.0	1	1003332	4014486461886
33	ENGINE C9	796474.0	1	1003217	4014486482454
34	FAN DRIVE	796450.0	1	1003969	4014486480610
	DRUM DRIVE VARIABLE SPEED	667248.1	1	1001317	4014486497908
	HYBRID VARIABLE SPEED DRIVE	667248.1	1	1001317	4014486497908
	CUTTERBAR DRIVE - 2ND STAGE WITHOUT VARIABLE SPEED DRIVE	667454.1	2	1002870	4014486472981
	CUTTERBAR DRIVE - 3RD STAGE FOR VARIABLE SPEED DRIVE	667551.2	2	1000867	4014486473056
	CHOPPER DRIVE - 1ST STAGE	667958.1	1	1003598	4014486485073
	FAN DRIVE	742026.1	1	1003800	4014486518566

### LEXION 470 MONTANA

0	CLEANING, 1ST STAGE	644209.2	1	1004843	4014486715668
0	DRUM VARIATOR	667248.2	1	1001317	4014486497908
0	HYBRID VARIABLE SPEED DRIVE	667248.2	1	1001317	4014486497908
0	CUTTERBAR DRIVE 3RD STAGE WITH VARIABLE SPEED DRIVE	667551.0	2	1000867	4014486473056
0	CHOPPER DRIVE 1ST STAGE	667958.2	1	1003598	4014486485073
2	CUTTERBAR DRIVE, 1ST STAGE	667255.0	1	1003357	4014486488951
2	CUTTERBAR DRIVE, 1ST STAGE	667255.1	1	1003357	4014486488951
3	THRESHING MECHANISM DRIVE	352403.0	1	1001253	4014486492101
4	GRAIN TANK UNLOADING	667250.0	1	1001586	4014486484960
5	CHOPPER DRIVE 1ST STAGE	667958.3	1	1001593	4014486485080
6	SIEVE PAN, 2ND STAGE	667252.0	1	1003602	4014486485349
7	CHOPPER DRIVE 2ND STAGE	061700.1	1	1003356	4014486486131
8	CHOPPER DRIVE 3RD STAGE	350463.0	1	1001665	4014486486278
9	CUTTERBAR DRIVE 2ND STAGE WITHOUT VARIABLE SPEED DRIVE	667454.0	2	1002870	4014486472981
10	CUTTERBAR DRIVE 3RD STAGE WITH VARIABLE SPEED DRIVE	667551.1	2	1000867	4014486473056
11	SYNCHRONOUS DRIVE	667249.0	1	1003591	4014486484762
12	CUTTERBAR VARIATOR	667530.0	1	1001163	4014486497441
13	CHAFF SPREADER	758719.0	1	1003405	4014486463309
14	CLEANING, 3RD STAGE	667651.0	1	1001706	4014486486834
15	CLEANING, 1ST STAGE	644209.0	1	1000699	4014486470826
15	CLEANING, 1ST STAGE	644209.1	1	1004843	4014486715668
16	HYBRID DRIVE, 2ND STAGE	629510.0	1	1003634	4014486488623
16	HYBRID DRIVE, 2ND STAGE	629510.1	1	1003634	4014486488623
17	HYBRID DRIVE, 1ST STAGE	749886.1	1	1001928	4014486489972
22	DRUM VARIATOR	667248.0	1	1001317	4014486497908
23	DRUM DRIVE	176442.0	1	1003641	4014486489033
23	DRUM DRIVE	176442.1	1	1003641	4014486489033
25	FAN DRIVE	742026.0	1	1000328	4014486465587
26	SUCTION FAN	644781.0	1	1000123	4014486461350
27	FAN VARIATOR	667457.0	1	1001079	4014486498233
28	PRE - DRUM DRIVE	667251.1	1	1003601	4014486485219
29	HYDRAULIC REEL DRIVE	829094.0	1	1000245	4014486463712
30	STRAW SPREADER	539443.0	1	No AP	
31	HYBRID VARIABLE SPEED DRIVE	667248.0	1	1001317	4014486497908
32	RADIATOR SCREEN 2ND STAGE	545689.0	1	1003332	4014486461886
33	ENGINE C9	796474.0	1	1003217	4014486482454
34	FAN DRIVE	796450.0	1	1003969	4014486480610
	DRUM VARIATOR	667248.1	1	1001317	4014486497908
	HYBRID VARIABLE SPEED DRIVE	667248.1	1	1001317	4014486497908
	CUTTERBAR DRIVE 2ND STAGE WITHOUT VARIABLE SPEED DRIVE	667454.1	2	1002870	4014486472981
	CUTTERBAR VARIATOR	667530.1	1	1001163	4014486497441
	CUTTERBAR DRIVE 3RD STAGE WITH VARIABLE SPEED DRIVE	667551.2	2	1000867	4014486473056
	CHOPPER DRIVE 1ST STAGE	667958.1	1	1003598	4014486485073
	FAN DRIVE	742026.1	1	1003800	4014486518566

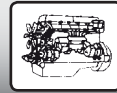
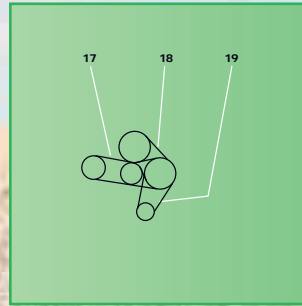
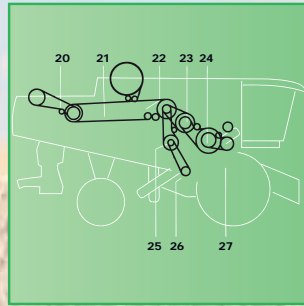
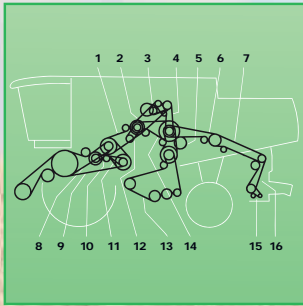

# CLAAS

## LEXION 480

0	SIEVE PAN DRIVE - 1ST STAGE	644209.2	1	1004843	4014486715668
0	THRESHING DRUM VARIATOR DRIVE	667248.2	1	1001317	4014486497908
0	UNI SPREADER DRIVE - 1ST STAGE	667798.0	1	1000307	4014486465143
0	KNIFE DRIVE	742025.0	1	1000650	4014486470123
0	FAN DRIVE - 1ST STAGE	742026.1	1	1003800	4014486518566
1	CLUTCH FOR CUTTERBAR DRIVE	667255.0	1	1003357	4014486488951
1	CLUTCH FOR CUTTERBAR DRIVE	667255.1	1	1003357	4014486488951
2	TENSIONER FOR THRESHING MECHANICAL DRIVE	667881.0	1	1001320	4014486492828
3	DISCHARGE DRIVE GRAIN TANK	667250.0	1	1001586	4014486484960
4	STRAW CHOPPER DRIVE - 1ST STAGE	644685.0	1	1003359	4014486488449
4	STRAW CHOPPER DRIVE - 1ST STAGE	644685.1	1	1003359	4014486488449
5	SIEVE PAN DRIVE - 2ND STAGE	667252.0	1	1003602	4014486485349
6	STRAW CHOPPER DRIVE - 2ND STAGE	061700.1	1	1003356	4014486486131
7	STRAW CHOPPER DRIVE - 2ND STAGE	661298.0	1	1001630	4014486485738
7	STRAW CHOPPER DRIVE - 2ND STAGE	749712.0	1	1003611	4014486486230
8	CUTTERBAR DRIVE WITHOUT VARIATOR DRIVE	667454.0	2	1002870	4014486472981
9	CUTTERBAR DRIVE WITH VARIABLE SPEED DRIVE	667551.0	2	1000867	4014486473056
9	CUTTERBAR DRIVE WITH VARIABLE SPEED DRIVE	667551.2	2	1000867	4014486473056
10	IMPELLER DRUM DRIVE	667249.0	1	1003591	4014486484762
11	CUTTERBAR DRIVE WITH VARIABLE SPEED DRIVE	667530.0	1	1001163	4014486497441
12	HYDRAULIC PUMP DRIVE	233843.1	1	1000237	4014486463408
12	HYDRAULIC PUMP DRIVE	758719.0	1	1003405	4014486463309
13	SIEVE PAN DRIVE 2RD STAGE	667651.0	1	1001706	4014486486834
14	SIEVE PAN DRIVE - 1ST STAGE	644209.0	1	1000699	4014486470826
14	SIEVE PAN DRIVE - 1ST STAGE	644209.1	1	1004843	4014486715668
15	UNI SPREADER DRIVE - 2ND STAGE	667891.0	1	1001013	4014486487954
16	UNI SPREADER DRIVE - 1ST STAGE	667798.2	1	1000310	4014486465198
17	COMPRESSOR DRIVE	667560.0	1	1002597	4014486496024
17	COMPRESSOR DRIVE	667560.1	1	1002597	4014486496024
18	ROTARY SCREEN FAN AND DRIVE	667242.0	1	1000225	4014486463033
19	ROTARY SCREEN DRIVE	667456.0	1	1002554	4014486494914
20	HYBRID DRIVE - 2ND STAGE	667427.0	1	1001839	4014486488654
20	HYBRID DRIVE - 2ND STAGE	667983.0	1	1003645	4014486489194
21	HYBRID DRIVE - 1ST STAGE	667554.0	1	1001926	4014486489941
22	ROTARY SCREEN DRIVE	667561.1	1	1000168	4014486461930
23	THRESHING DRUM VARIATOR DRIVE	667248.0	1	1001317	4014486497908
24	THRESHING DRUM VARIATOR DRIVE	667458.0	1	1003642	4014486489101
25	FAN DRIVE - 1ST STAGE	742026.0	1	1000328	4014486465587
26	FAN INTERMEDIATE DRIVE	667457.0	1	1001079	4014486498233
27	SPEED REDUCING GEAR BOX	667251.0	1	1003601	4014486485219
	THRESHING DRUM VARIATOR DRIVE	667248.1	1	1001317	4014486497908
	SPEED REDUCING GEAR BOX	667251.1	1	1003601	4014486485219
	CUTTERBAR DRIVE WITHOUT VARIATOR DRIVE	667454.1	2	1002870	4014486472981
	CUTTERBAR DRIVE WITH VARIABLE SPEED DRIVE	667530.1	1	1001163	4014486497441
	CUTTERBAR DRIVE WITH VARIABLE SPEED DRIVE	667551.1	2	1000867	4014486473056
	UNI SPREADER DRIVE - 1ST STAGE	667798.1	1	1000307	4014486465143
	UNI SPREADER DRIVE - 2ND STAGE	667891.1	1	1001012	4014486487947

## LEXION 480 II

0	CLEANING, 1ST STAGE	644209.2	1	1004843	4014486715668
0	DRUM VARIATOR	667248.2	1	1001317	4014486497908
0	HYBRID VARIABLE SPEED DRIVE	667248.2	1	1001317	4014486497908
0	CUTTERBAR DRIVE, 3RD STAGE WITH VARIABLE SPEED DRIVE	667551.0	2	1000867	4014486473056

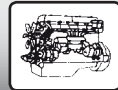

## CLAAS

0	FAN DRIVE	742026.1	1	1003800	4014486518566
2	CUTTERBAR DRIVE, 1ST STAGE	667255.0	1	1003357	4014486488951
2	CUTTERBAR DRIVE, 1ST STAGE	667255.1	1	1003357	4014486488951
3	THRESHING MECHANISM DRIVE	667881.0	1	1001320	4014486492828
4	GRAIN TANK UNLOADING	667250.0	1	1001586	4014486484960
5	CHOPPER DRIVE 1ST STAGE	644966.0	1	1001823	4014486488425
6	SIEVE PAN, 2ND STAGE	667252.0	1	1003602	4014486485349
7	CHOPPER DRIVE, 2ND STAGE	644889.0	1	1001658	4014486486148
8	CHOPPER DRIVE, 3RD STAGE ONLY FOR RICE	350463.0	1	1001665	4014486486278
8	STRENGTHENED DRIVE	644890.0	1	1001664	4014486486247
9	CUTTERBAR DRIVE, 2ND STAGE WITHOUT VARIABLE SPEED DRIVE	667454.0	2	1002870	4014486472981
10	CUTTERBAR DRIVE, 3RD STAGE WITH VARIABLE SPEED DRIVE	667551.1	2	1000867	4014486473056
11	SYNCHRONOUS DRIVE	667249.0	1	1003591	4014486484762
12	CUTTERBAR VARIATOR	667530.1	1	1001163	4014486497441
13	AT SPREADER FAN	233843.1	1	1000237	4014486463408
13	AT CHAFF SPREADER	758719.0	1	1003405	4014486463309
14	CLEANING, 3RD STAGE	644866.0	1	1003618	4014486486865
15	CLEANING, 1ST STAGE	644209.0	1	1000699	4014486470826
15	CLEANING, 1ST STAGE	644209.1	1	1004843	4014486715668
16	HYBRID DRIVE, 2ND STAGE	629510.0	1	1003634	4014486488623
16	HYBRID DRIVE, 2ND STAGE	629510.1	1	1003634	4014486488623
17	HYBRID DRIVE, 1ST STAGE	749886.1	1	1001928	4014486489972
18	RADIATOR SCREEN 2ND STAGE	545689.0	1	1003332	4014486461886
19	FAN DRIVE / C12	761979.1	1	1002668	4014486482027
22	DRUM VARIATOR	667248.0	1	1001317	4014486497908
23	DRUM DRIVE	176442.0	1	1003641	4014486489033
23	DRUM DRIVE	176442.1	1	1003641	4014486489033
25	FAN DRIVE	742026.0	1	1000328	4014486465587
26	SUCTION FAN	644781.0	1	1000123	4014486461350
27	FAN VARIATOR	667457.0	1	1001079	4014486498233
28	PRE - DRUM DRIVE	667251.1	1	1003601	4014486485219
29	HYDRAULIC REEL DRIVE	829094.0	1	1000245	4014486463712
30	STRAW SPREADER	539443.0	1	No AP	
31	HYBRID VARIABLE SPEED DRIVE	667248.0	1	1001317	4014486497908
32	SPREADER FAN, 2ND STAGE	667891.1	1	1001012	4014486487947
33	SPREADER FAN, 1ST STAGE	644942.0	1	1001385	4014486475012
34	SUCTION BLOWER E - CHANNEL	765985.0	1	1002287	4014486479706
	DRUM VARIATOR	667248.1	1	1001317	4014486497908
	HYBRID VARIABLE SPEED DRIVE	667248.1	1	1001317	4014486497908
	CUTTERBAR DRIVE, 2ND STAGE WITHOUT VARIABLE SPEED DRIVE	667454.1	2	1002870	4014486472981
	CUTTERBAR DRIVE, 3RD STAGE WITH VARIABLE SPEED DRIVE	667551.2	2	1000867	4014486473056

## LEXION 480 II MTS

0	CLEANING, 1ST STAGE	644209.2	1	1004843	4014486715668
0	DRUM VARIATOR	667248.2	1	1001317	4014486497908
0	HYBRID VARIABLE SPEED DRIVE	667248.2	1	1001317	4014486497908
0	CUTTERBAR DRIVE 3RD STAGE WITH VARIABLE SPEED DRIVE	667551.0	2	1000867	4014486473056
0	FAN DRIVE	742026.1	1	1003800	4014486518566
2	CUTTERBAR DRIVE, 1ST STAGE	667255.0	1	1003357	4014486488951
2	CUTTERBAR DRIVE, 1ST STAGE	667255.1	1	1003357	4014486488951
3	THRESHING MECHANISM DRIVE	667881.0	1	1001320	4014486492828
4	GRAIN TANK UNLOADING	667250.0	1	1001586	4014486484960
5	CHOPPER DRIVE, 1ST STAGE	644966.0	1	1001823	4014486488425
6	SIEVE PAN, 2ND STAGE	667252.0	1	1003602	4014486485349
7	CHOPPER DRIVE 2ND STAGE	644889.0	1	1001658	4014486486148

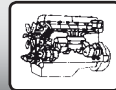

## CLAAS

8	CHOPPER DRIVE 3RD STAGE ONLY FOR RICE	350463.0	1	1001665	4014486486278
8	STRENGTHENED DRIVE	644890.0	1	1001664	4014486486247
9	CUTTERBAR DRIVE 2ND STAGE WITHOUT VARIABLE SPEED DRIVE	667454.0	2	1002870	4014486472981
10	CUTTERBAR DRIVE 3RD STAGE WITH VARIABLE SPEED DRIVE	667551.1	2	1000867	4014486473056
11	SYNCHRONOUS DRIVE	667249.0	1	1003591	4014486484762
12	CUTTERBAR VARIATOR	667530.1	1	1001163	4014486497441
13	AT SPREADER FAN	233843.1	1	1000237	4014486463408
13	AT CHAFF SPREADER	758719.0	1	1003405	4014486463309
14	CLEANING, 3RD STAGE	644866.0	1	1003618	4014486486865
15	CLEANING, 1ST STAGE	644209.0	1	1000699	4014486470826
15	CLEANING, 1ST STAGE	644209.1	1	1004843	4014486715668
16	HYBRID DRIVE, 2ND STAGE	629510.0	1	1003634	4014486488623
16	HYBRID DRIVE, 2ND STAGE	629510.1	1	1003634	4014486488623
17	HYBRID DRIVE, 1ST STAGE	749886.1	1	1001928	4014486489972
18	RADIATOR SCREEN 2ND STAGE	545689.0	1	1003332	4014486461886
19	FAN DRIVE / C12	761979.1	1	1002668	4014486482027
22	DRUM VARIATOR	667248.0	1	1001317	4014486497908
23	DRUM DRIVE	176442.0	1	1003641	4014486489033
23	DRUM DRIVE	176442.1	1	1003641	4014486489033
25	FAN DRIVE	742026.0	1	1000328	4014486465587
26	SUCTION FAN	644781.0	1	1000123	4014486461350
27	FAN VARIATOR	667457.0	1	1001079	4014486498233
28	PRE - DRUM DRIVE	667251.1	1	1003601	4014486485219
29	HYDRAULIC REEL DRIVE	829094.0	1	1000245	4014486463712
30	STRAW SPREADER	539443.0	1	No AP	
31	HYBRID VARIABLE SPEED DRIVE	667248.0	1	1001317	4014486497908
32	SPREADER FAN, 2ND STAGE	667891.1	1	1001012	4014486487947
33	SPREADER FAN, 1ST STAGE	644942.0	1	1001385	4014486475012
34	SUCTION BLOWER E - CHANNEL	765985.0	1	1002287	4014486479706
	DRUM VARIATOR	667248.1	1	1001317	4014486497908
	HYBRID VARIABLE SPEED DRIVE	667248.1	1	1001317	4014486497908
	CUTTERBAR DRIVE 2ND STAGE WITHOUT VARIABLE SPEED DRIVE	667454.1	2	1002870	4014486472981
	CUTTERBAR DRIVE 3RD STAGE WITH VARIABLE SPEED DRIVE	667551.2	2	1000867	4014486473056

## LEXION 480 TERRA

0	1ST STAGE CLEANING	644209.2	1	1004843	4014486715668
0	DRUM VARIABLE SPEED DRIVE	667248.2	1	1001317	4014486497908
0	3RD STAGE CUTTERBAR WITH VARIABLE SPEED DRIVE	667551.0	2	1000867	4014486473056
0	1ST EACH SPREADER BLOWER TO NO. 46800033	667798.0	1	1000307	4014486465143
0	1ST STAGE BLOWER	742026.1	1	1003800	4014486518566
1	1ST STAGE CUTTERBAR	667255.0	1	1003357	4014486488951
1	1ST STAGE CUTTERBAR	667255.1	1	1003357	4014486488951
2	THRESHING MECHANISM	667881.0	1	1001320	4014486492828
3	GRAIN TANK UNLOADING	667250.0	1	1001586	4014486484960
4	1ST STAGE CHOPPER TO NO. 46800070	644685.1	1	1003359	4014486488449
4	1ST STAGE CHOPPER FROM NO. 46800071	644966.0	1	1001823	4014486488425
5	2ND STAGE CLEANING	667252.0	1	1003602	4014486485349
6	2ND STAGE CHOPPER TO NO. 46800070	061700.1	1	1003356	4014486486131
6	2ND STAGE CHOPPER FROM NO. 46800071	644889.0	1	1001658	4014486486148
7	3RD STAGE CHOPPER FROM NO. 46800071	644890.0	1	1001664	4014486486247
7	3RD STAGE CHOPPER TO NO. 46800070	749712.0	1	1003611	4014486486230
8	2ND STAGE CUTTERBAR WITHOUT VARIABLE SPEED DRIVE	667454.0	2	1002870	4014486472981
9	3RD STAGE CUTTERBAR WITH VARIABLE SPEED DRIVE	667551.1	2	1000867	4014486473056
10	IMPELLER DRUM	667249.0	1	1003591	4014486484762
11	CUTTERBAR VARIABLE SPEED DRIVE	667530.0	1	1001163	4014486497441

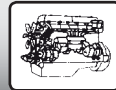

## CLAAS

12	STRAW SPREADER	233843.1	1	1000237	4014486463408
12	STRAW SPREADER	758719.0	1	1003405	4014486463309
13	3RD STAGE CLEANING	644866.0	1	1003618	4014486486865
14	1ST STAGE CLEANING	644209.0	1	1000699	4014486470826
14	1ST STAGE CLEANING	644209.1	1	1004843	4014486715668
15	2ND STAGE SPREADER BLOWER	667891.1	1	1001012	4014486487947
16	1ST EACH SPREADER BLOWER FROM NO. 46800034	644942.0	1	1001385	4014486475012
16	1ST EACH SPREADER BLOWER TO NO. 46800033	667798.2	1	1000310	4014486465198
17	COMPRESSOR	667560.0	1	1002597	4014486496024
17	COMPRESSOR	667560.1	1	1002597	4014486496024
18	MOTOR FAN	667242.0	1	1000225	4014486463033
19	1ST STAGE RADIATOR SCREEN	667456.0	1	1002554	4014486494914
20	2ND STAGE HYBRID FROM NO. 46800081	629510.0	1	1003634	4014486488623
20	2ND STAGE HYBRID FROM NO. 46800081	629510.1	1	1003634	4014486488623
20	BEI N = 300 MIN-1	667458.0	1	1003642	4014486489101
20	2ND STAGE HYBRID TO NO. 46800080	667983.0	1	1003645	4014486489194
21	1ST STAGE HYBRID TO NO. 46800080	667554.0	1	1001926	4014486489941
21	1ST STAGE HYBRID FROM NO. 46800081	749886.1	1	1001928	4014486489972
22	2ND STAGE RADIATOR SCREEN	667561.1	1	1000168	4014486461930
23	DRUM VARIBALE SPEED DRIVE	667248.0	1	1001317	4014486497908
24	THRESHING DRUM	176442.0	1	1003641	4014486489033
24	THRESHING DRUM	176442.1	1	1003641	4014486489033
24	THRESHING DRUM AT DISC 644878.1 OPTIONAL	667255.0	1	1003357	4014486488951
24	THRESHING DRUM AT DISC 644878.1 OPTIONAL	667255.1	1	1003357	4014486488951
25	1ST STAGE BLOWER	742026.0	1	1000328	4014486465587
26	FAN VARIABLE SPEED DRIVE	667457.0	1	1001079	4014486498233
27	ACCELERATOR	667251.1	1	1003601	4014486485219
28	SUCTION FAN	644781.0	1	1000123	4014486461350
	DRUM VARIBALE SPEED DRIVE	667248.1	1	1001317	4014486497908
	2ND STAGE CUTTERBAR WITHOUT VARIABLE SPEED DRIVE	667454.1	2	1002870	4014486472981
	CUTTERBAR VARIABLE SPEED DRIVE	667530.1	1	1001163	4014486497441
	3RD STAGE CUTTERBAR WITH VARIABLE SPEED DRIVE	667551.2	2	1000867	4014486473056
	1ST EACH SPREADER BLOWER TO NO. 46800033	667798.1	1	1000307	4014486465143

## LEXION 510

0	CLEANING, 1ST STAGE	644209.2	1	1004843	4014486715668
0	DRUM VARIATOR FROM NO. 58300369	667248.2	1	1001317	4014486497908
0	CUTTERBAR DRIVE, 3RD STAGE WITH VARIABLE SPEED DRIVE	667551.0	2	1000867	4014486473056
0	CHOPPER DRIVE 1ST STAGE AT MOTOR 3126B AND C9 - EXHAUST LEVEL 3A	667958.2	1	1003598	4014486485073
0	CHAFF SPREADER	746508.3	1	1000266	4014486464252
2	CUTTERBAR DRIVE, 1ST STAGE	644892.0	1	1001860	4014486488968
3	THRESHING MECHANISM DRIVE P02/540/541/560/P02/670/671/680/681	352371.1	1	1001982	4014486491012
3	THRESHING MECHANISM DRIVE P02/590/591/660/661	667453.0	1	1003350	4014486492095
4	GRAIN TANK UNLOADING	667250.0	1	1001586	4014486484960
5	CHOPPER DRIVE 1ST STAGE AT MOTOR C6.6	355696.0	1	1004835	4014486717099
5	CHOPPER DRIVE 1ST STAGE AT MOTOR 3126B AND C9 - EXHAUST LEVEL 3A	667958.3	1	1001593	4014486485080
6	SIEVE PAN, 2ND STAGE	667252.0	1	1003602	4014486485349
7	CHOPPER DRIVE, 2ND STAGE	061700.1	1	1003356	4014486486131
8	CHOPPER DRIVE, 3RD STAGE RIGID CHOPPER	628888.0	1	1001684	4014486486551
9	CUTTERBAR DRIVE, 2ND STAGE WITHOUT VARIABLE SPEED DRIVE	667454.0	2	1002870	4014486472981
10	CUTTERBAR DRIVE, 3RD STAGE WITH VARIABLE SPEED DRIVE	667551.1	2	1000867	4014486473056
11	SYNCHRONOUS DRIVE	667249.0	1	1003591	4014486484762
12	CUTTERBAR VARIATOR	667530.1	1	1001163	4014486497441
13	CHAFF SPREADER	746508.1	1	1000266	4014486464252
14	CLEANING, 3RD STAGE	667651.0	1	1001706	4014486486834



## CLAAS

15	CLEANING, 1ST STAGE	644209.0	1	1000699	4014486470826
15	CLEANING, 1ST STAGE	644209.1	1	1004843	4014486715668
19	FINGER ROLLER	628991.0	1	1000433	4014486467000
22	DRUM VARIATOR	661427.0	1	1001228	4014486497847
22	DRUM VARIATOR FROM NO. 58300369	667248.0	1	1001317	4014486497908
23	DRUM DRIVE	176442.0	1	1003641	4014486489033
23	DRUM DRIVE	176442.1	1	1003641	4014486489033
23	DRUM DRIVE	644902.0	1	1001639	4014486485905
25	FAN DRIVE	778717.1	2	1004307	4014486714937
26	SUCTION BLOWER	644843.0	1	1002286	4014486479690
27	FAN VARIATOR	667457.0	1	1001079	4014486498233
28	PRE - DRUM DRIVE	667251.1	1	1003601	4014486485219
29	HYDRAULIC REEL DRIVE	829094.0	1	1000245	4014486463712
30	STRAW WALKER DRIVE	667477.0	1	1000387	4014486466508
31	STRAW SPREADER	539443.0	1	No AP	
33	RADIATOR SCREEN 2ND STAGE	545689.0	1	1003332	4014486461886
34	AT MOTOR 3126B	796474.0	1	1003217	4014486482454
35	AT MOTOR C6.6	580157.0	1	1003786	4014486481334
35	AT MOTOR C9	584627.0	1	1002652	4014486481259
35	AT MOTOR C9	584627.1	1	1002652	4014486481259
35	FAN DRIVE AT MOTOR 3126B	796450.0	1	1003969	4014486480610
36	SUCTION BLOWER E - CHANNEL	765985.0	1	1002287	4014486479706
	DRUM VARIATOR FROM NO. 58300369	667248.1	1	1001317	4014486497908
	CUTTERBAR DRIVE, 2ND STAGE WITHOUT VARIABLE SPEED DRIVE	667454.1	2	1002870	4014486472981
	CUTTERBAR DRIVE, 3RD STAGE WITH VARIABLE SPEED DRIVE	667551.2	2	1000867	4014486473056
	CHOPPER DRIVE 1ST STAGE AT MOTOR 3126B AND C9 - EXHAUST LEVEL 3A	667958.1	1	1003598	4014486485073

## LEXION 520 MONTANA

0	CLEANING, 1ST STAGE	644209.2	1	1004843	4014486715668
0	DRUM VARIATOR	667248.2	1	1001317	4014486497908
0	CUTTERBAR DRIVE 3RD STAGE WITH VARIABLE SPEED DRIVE	667551.0	2	1000867	4014486473056
0	CHOPPER DRIVE 1ST STAGE AT MOTOR 3126B, C9	667958.2	1	1003598	4014486485073
0	CHAFF SPREADER	746508.3	1	1000266	4014486464252
2	CUTTERBAR DRIVE 1ST STAGE	644892.0	1	1001860	4014486488968
3	THRESHING MECHANISM DRIVE P02/540/541/670/671	352371.1	1	1001982	4014486491012
3	THRESHING MECHANISM DRIVE P02/660/661 FROM NO. 58200137	352403.0	1	1001253	4014486492101
3	THRESHING MECHANISM DRIVE P02/590/591 P02/660/661	667453.0	1	1003350	4014486492095
4	GRAIN TANK UNLOADING	667250.0	1	1001586	4014486484960
5	CHOPPER DRIVE 1ST STAGE AT MOTOR C6.6	355696.0	1	1004835	4014486717099
5	CHOPPER DRIVE 1ST STAGE AT MOTOR 3126B, C9	667958.3	1	1001593	4014486485080
6	SIEVE PAN 2ND STAGE	667252.0	1	1003602	4014486485349
7	CHOPPER DRIVE 2ND STAGE	061700.1	1	1003356	4014486486131
8	CHOPPER DRIVE 3RD STAGE RIGID CHOPPER	628888.0	1	1001684	4014486486551
9	CUTTERBAR DRIVE 2ND STAGE WITHOUT VARIABLE SPEED DRIVE	667454.0	2	1002870	4014486472981
10	CUTTERBAR DRIVE 3RD STAGE WITH VARIABLE SPEED DRIVE	667551.1	2	1000867	4014486473056
11	SYNCHRONOUS DRIVE	667249.0	1	1003591	4014486484762
12	CUTTERBAR VARIATOR	667530.1	1	1001163	4014486497441
13	CHAFF SPREADER	746508.1	1	1000266	4014486464252
14	CLEANING, 3RD STAGE	667651.0	1	1001706	4014486486834
15	CLEANING, 1ST STAGE	644209.0	1	1000699	4014486470826
15	CLEANING, 1ST STAGE	644209.1	1	1004843	4014486715668
19	FINGER ROLLER	628991.0	1	1000433	4014486467000
22	DRUM VARIATOR	667248.0	1	1001317	4014486497908
23	DRUM DRIVE	176442.0	1	1003641	4014486489033
23	DRUM DRIVE	176442.1	1	1003641	4014486489033





## CLAAS

25	FAN DRIVE	746506.0	4	1002784	4014486465716
26	SUCTION FAN	644781.0	1	1000123	4014486461350
27	FAN VARIATOR	667457.0	1	1001079	4014486498233
28	PRE - DRUM DRIVE	667251.1	1	1003601	4014486485219
29	HYDRAULIC REEL DRIVE	829094.0	1	1000245	4014486463712
30	STRAW WALKER DRIVE	667477.0	1	1000387	4014486466508
31	STRAW SPREADER	539443.0	1	No AP	
33	RADIATOR SCREEN 2ND STAGE	545689.0	1	1003332	4014486461886
34	AT MOTOR 3126B	796474.0	1	1003217	4014486482454
35	AT MOTOR C6.6	580157.0	1	1003786	4014486481334
35	AT MOTOR C9	584627.1	1	1002652	4014486481259
35	FAN DRIVE AT MOTOR 3126B	796450.0	1	1003969	4014486480610
36	SUCTION BLOWER E - CHANNEL	765985.0	1	1002287	4014486479706
	DRUM VARIATOR	667248.1	1	1001317	4014486497908
	CUTTERBAR DRIVE 2ND STAGE WITHOUT VARIABLE SPEED DRIVE	667454.1	2	1002870	4014486472981
	CUTTERBAR DRIVE 3RD STAGE WITH VARIABLE SPEED DRIVE	667551.2	2	1000867	4014486473056
	CHOPPER DRIVE 1ST STAGE AT MOTOR 3126B, C9	667958.1	1	1003598	4014486485073

## LEXION 530

0	CLEANING, 1ST STAGE	644209.2	1	1004843	4014486715668
0	DRUM VARIATOR FROM NO. 58300369	667248.2	1	1001317	4014486497908
0	CUTTERBAR DRIVE, 3RD STAGE WITH VARIABLE SPEED DRIVE	667551.0	2	1000867	4014486473056
0	CHOPPER DRIVE 1ST STAGE AT MOTOR 3126B AND C9 - EXHAUST LEVEL 3A	667958.2	1	1003598	4014486485073
0	CHAFF SPREADER	746508.3	1	1000266	4014486464252
2	CUTTERBAR DRIVE, 1ST STAGE	644892.0	1	1001860	4014486488968
3	THRESHING MECHANISM DRIVE P02/540/541/560/P02/670/671/680/681	352371.1	1	1001982	4014486491012
3	THRESHING MECHANISM DRIVE P02/590/591/660/661	667453.0	1	1003350	4014486492095
4	GRAIN TANK UNLOADING	667250.0	1	1001586	4014486484960
5	CHOPPER DRIVE 1ST STAGE AT MOTOR C6.6	355696.0	1	1004835	4014486717099
5	CHOPPER DRIVE 1ST STAGE AT MOTOR 3126B AND C9 - EXHAUST LEVEL 3A	667958.3	1	1001593	4014486485080
6	SIEVE PAN, 2ND STAGE	667252.0	1	1003602	4014486485349
7	CHOPPER DRIVE, 2ND STAGE	061700.1	1	1003356	4014486486131
8	CHOPPER DRIVE, 3RD STAGE RIGID CHOPPER	628888.0	1	1001684	4014486486551
9	CUTTERBAR DRIVE, 2ND STAGE WITHOUT VARIABLE SPEED DRIVE	667454.0	2	1002870	4014486472981
10	CUTTERBAR DRIVE, 3RD STAGE WITH VARIABLE SPEED DRIVE	667551.1	2	1000867	4014486473056
11	SYNCHRONOUS DRIVE	667249.0	1	1003591	4014486484762
12	CUTTERBAR VARIATOR	667530.1	1	1001163	4014486497441
13	CHAFF SPREADER	746508.1	1	1000266	4014486464252
14	CLEANING, 3RD STAGE	667651.0	1	1001706	4014486486834
15	CLEANING, 1ST STAGE	644209.0	1	1000699	4014486470826
15	CLEANING, 1ST STAGE	644209.1	1	1004843	4014486715668
19	FINGER ROLLER	628991.0	1	1000433	4014486467000
22	DRUM VARIATOR FROM NO. 58300369	667248.0	1	1001317	4014486497908
23	DRUM DRIVE LEXION 530, 520, 510 FROM NO. 58300369	176442.0	1	1003641	4014486489033
23	DRUM DRIVE LEXION 530, 520, 510 FROM NO. 58300369	176442.1	1	1003641	4014486489033
25	FAN DRIVE	746506.0	4	1002784	4014486465716
26	SUCTION BLOWER	644781.0	1	1000123	4014486461350
27	FAN VARIATOR	667457.0	1	1001079	4014486498233
28	PRE - DRUM DRIVE	667251.1	1	1003601	4014486485219
29	HYDRAULIC REEL DRIVE	829094.0	1	1000245	4014486463712
30	STRAW WALKER DRIVE	667477.0	1	1000387	4014486466508
31	STRAW SPREADER	539443.0	1	No AP	
33	RADIATOR SCREEN 2ND STAGE	545689.0	1	1003332	4014486461886
34	AT MOTOR 3126B	796474.0	1	1003217	4014486482454
35	AT MOTOR C6.6	580157.0	1	1003786	4014486481334



## CLAAS

35	AT MOTOR C9	584627.1	1	1002652	4014486481259
35	FAN DRIVE AT MOTOR 3126B	796450.0	1	1003969	4014486480610
36	SUCTION BLOWER E - CHANNEL	765985.0	1	1002287	4014486479706
	DRUM VARIATOR FROM NO. 58300369	667248.1	1	1001317	4014486497908
	CUTTERBAR DRIVE, 2ND STAGE WITHOUT VARIABLE SPEED DRIVE	667454.1	2	1002870	4014486472981
	CUTTERBAR DRIVE, 3RD STAGE WITH VARIABLE SPEED DRIVE	667551.2	2	1000867	4014486473056
	CHOPPER DRIVE 1ST STAGE AT MOTOR 3126B AND C9 - EXHAUST LEVEL 3A	667958.1	1	1003598	4014486485073

## LEXION 530 MONTANA

0	CLEANING, 1ST STAGE	644209.2	1	1004843	4014486715668
0	DRUM VARIATOR	667248.2	1	1001317	4014486497908
0	CUTTERBAR DRIVE 3RD STAGE WITH VARIABLE SPEED DRIVE	667551.0	2	1000867	4014486473056
0	CHOPPER DRIVE 1ST STAGE AT MOTOR 3126B, C9	667958.2	1	1003598	4014486485073
0	CHAFF SPREADER	746508.3	1	1000266	4014486464252
2	CUTTERBAR DRIVE 1ST STAGE	644892.0	1	1001860	4014486488968
3	THRESHING MECHANISM DRIVE P02/540/541/670/671	352371.1	1	1001982	4014486491012
3	THRESHING MECHANISM DRIVE P02/660/661 FROM NO. 58200137	352403.0	1	1001253	4014486492101
3	THRESHING MECHANISM DRIVE P02/590/591 P02/660/661	667453.0	1	1003350	4014486492095
4	GRAIN TANK UNLOADING	667250.0	1	1001586	4014486484960
5	CHOPPER DRIVE 1ST STAGE AT MOTOR C6.6	355696.0	1	1004835	4014486717099
5	CHOPPER DRIVE 1ST STAGE AT MOTOR 3126B, C9	667958.3	1	1001593	4014486485080
6	SIEVE PAN 2ND STAGE	667252.0	1	1003602	4014486485349
7	CHOPPER DRIVE 2ND STAGE	061700.1	1	1003356	4014486486131
8	CHOPPER DRIVE 3RD STAGE RIGID CHOPPER	628888.0	1	1001684	4014486486551
9	CUTTERBAR DRIVE 2ND STAGE WITHOUT VARIABLE SPEED DRIVE	667454.0	2	1002870	4014486472981
10	CUTTERBAR DRIVE 3RD STAGE WITH VARIABLE SPEED DRIVE	667551.1	2	1000867	4014486473056
11	SYNCHRONOUS DRIVE	667249.0	1	1003591	4014486484762
12	CUTTERBAR VARIATOR	667530.1	1	1001163	4014486497441
13	CHAFF SPREADER	746508.1	1	1000266	4014486464252
14	CLEANING, 3RD STAGE	667651.0	1	1001706	4014486486834
15	CLEANING, 1ST STAGE	644209.0	1	1000699	4014486470826
15	CLEANING, 1ST STAGE	644209.1	1	1004843	4014486715668
19	FINGER ROLLER	628991.0	1	1000433	4014486467000
22	DRUM VARIATOR	667248.0	1	1001317	4014486497908
23	DRUM DRIVE	176442.0	1	1003641	4014486489033
23	DRUM DRIVE	176442.1	1	1003641	4014486489033
25	FAN DRIVE	746506.0	4	1002784	4014486465716
26	SUCTION FAN	644781.0	1	1000123	4014486461350
27	FAN VARIATOR	667457.0	1	1001079	4014486498233
28	PRE - DRUM DRIVE	667251.1	1	1003601	4014486485219
29	HYDRAULIC REEL DRIVE	829094.0	1	1000245	4014486463712
30	STRAW WALKER DRIVE	667477.0	1	1000387	4014486466508
31	STRAW SPREADER	539443.0	1	No AP	
33	RADIATOR SCREEN 2ND STAGE	545689.0	1	1003332	4014486461886
34	AT MOTOR 3126B	796474.0	1	1003217	4014486482454
35	AT MOTOR C6.6	580157.0	1	1003786	4014486481334
35	AT MOTOR C9	584627.1	1	1002652	4014486481259
35	FAN DRIVE AT MOTOR 3126B	796450.0	1	1003969	4014486480610
36	SUCTION BLOWER E - CHANNEL	765985.0	1	1002287	4014486479706
	DRUM VARIATOR	667248.1	1	1001317	4014486497908
	CUTTERBAR DRIVE 2ND STAGE WITHOUT VARIABLE SPEED DRIVE	667454.1	2	1002870	4014486472981
	CUTTERBAR DRIVE 3RD STAGE WITH VARIABLE SPEED DRIVE	667551.2	2	1000867	4014486473056
	CHOPPER DRIVE 1ST STAGE AT MOTOR 3126B, C9	667958.1	1	1003598	4014486485073



# CLAAS

## LEXION 540

0	CLEANING - 1ST STAGE	644209.2	1	1004843	4014486715668
0	DRUM DRIVE VARIABLE SPEED	667248.2	1	1001317	4014486497908
0	CUTTERBAR DRIVE - 3RD STAGE WITH VARIABLE SPEED	667551.0	2	1000867	4014486473056
0	CHOPPER DRIVE - 1ST STAGE AT MOTOR C13, C10, C9 AND 3126B	667958.2	1	1003598	4014486485073
0	CHAFF SPREADER DRIVE	746508.3	1	1000266	4014486464252
2	CUTTERBAR DRIVE - 1ST STAGE	644892.0	1	1001860	4014486488968
3	THRESHING MECHANISM ENGINE C9	352403.0	1	1001253	4014486492101
3	THRESHING MECHANISM ENGINE 3126B, C6.6	667453.0	1	1003350	4014486492095
3	THRESHING MECHANISM AT CATERPILLAR C13, C10	667881.0	1	1001320	4014486492828
4	DISCHARGE DRIVE GRAIN TANK	667250.0	1	1001586	4014486484960
5	CHOPPER DRIVE - 1ST STAGE AT MOTOR C6.6	355696.0	1	1004835	4014486717099
5	CHOPPER DRIVE - 1ST STAGE AT MOTOR C13, C10, C9 AND 3126B	667958.3	1	1001593	4014486485080
6	SIEVE PAN DRIVE - 2ND STAGE	667252.0	1	1003602	4014486485349
7	CHOPPER DRIVE - 2ND STAGE	061700.1	1	1003356	4014486486131
8	CHOPPER DRIVE - 3RD STAGE RIGID CHOPPER	628888.0	1	1001684	4014486486551
9	CUTTERBAR DRIVE - 2ND WITHOUT VARIABLE SPEED	667454.0	2	1002870	4014486472981
10	CUTTERBAR DRIVE - 3RD STAGE WITH VARIABLE SPEED	667551.1	2	1000867	4014486473056
11	SYNCHRONOUS DRIVE	667249.0	1	1003591	4014486484762
12	CUTTERBAR DRIVE WITH VARIABLE SPEED DRIVE	667530.1	1	1001163	4014486497441
13	CHAFF SPREADER DRIVE	746508.1	1	1000266	4014486464252
14	CLEANING - 3RD STAGE	667651.0	1	1001706	4014486486834
15	CLEANING - 1ST STAGE	644209.0	1	1000699	4014486470826
15	CLEANING - 1ST STAGE	644209.1	1	1004843	4014486715668
19	FINGER ROLLER	628991.0	1	1000433	4014486467000
22	DRUM DRIVE VARIABLE SPEED	667248.0	1	1001317	4014486497908
23	DRUM DRIVE	176442.0	1	1003641	4014486489033
23	DRUM DRIVE	176442.1	1	1003641	4014486489033
25	FAN DRIVE	746506.0	4	1002784	4014486465716
26	SUCTION FAN	644781.0	1	1000123	4014486461350
27	FAN DRIVE VARIABLE SPEED	667457.0	1	1001079	4014486498233
28	PRE-DRUM DRIVE	667251.1	1	1003601	4014486485219
29	HYDRAULIC REEL PUMP DRIVE	829094.0	1	1000245	4014486463712
30	STRAW WALKER DRIVE	667477.0	1	1000387	4014486466508
31	STRAW SPREADER DRIVE	539443.0	1	No AP	
33	RADIATOR SCREEN 2ND STAGE	545689.0	1	1003332	4014486461886
34	ENGINE 3126 B	796474.0	1	1003217	4014486482454
34	ENGINE C9 EMISSION STANDARD 2	796786.0	1	1003220	4014486482478
35	FAN DRIVE AT MOTOR C6.6	580157.0	1	1003786	4014486481334
35	FAN DRIVE C9-EXHAUST LEVEL 3A	584627.1	1	1002652	4014486481259
35	FAN DRIVE - ENGINE C10, C13 (FROM NR. 58401487)	628964.1	1	1002687	4014486482850
35	FAN DRIVE (UP TO NR. 58401486)	743910.1	1	1003202	4014486482041
35	FAN DRIVE - ENGINE 3126B AND AT C9-EMISSION STANDARD	796450.0	1	1003969	4014486480610
36	SUCTION BLOWER E.-CHANNEL	765985.0	1	1002287	4014486479706
	DRUM DRIVE VARIABLE SPEED	667248.1	1	1001317	4014486497908
	CUTTERBAR DRIVE - 2ND WITHOUT VARIABLE SPEED	667454.1	2	1002870	4014486472981
	CUTTERBAR DRIVE - 3RD STAGE WITH VARIABLE SPEED	667551.2	2	1000867	4014486473056
	CHOPPER DRIVE - 1ST STAGE AT MOTOR C13, C10, C9 AND 3126B	667958.1	1	1003598	4014486485073

## LEXION 550 MONTANA

0	CLEANING - 1ST STAGE	644209.2	1	1004843	4014486715668
0	DRUM VARIATOR	667248.2	1	1001317	4014486497908
0	CUTTERBAR DRIVE 3RD STAGE WITH VARIABLE SPEED DRIVE	667551.0	2	1000867	4014486473056
0	CHOPPER DRIVE 1ST STAGE	667958.2	1	1003598	4014486485073



## CLAAS

0	CHAFF SPREADER	746508.3	1	1000266	4014486464252
2	CUTTERBAR DRIVE 1ST STAGE	644892.0	1	1001860	4014486488968
3	THRESHING MECHANISM DRIVE ENGINE C9	352403.0	1	1001253	4014486492101
3	THRESHING MECHANISM DRIVE ENGINE C10	667881.0	1	1001320	4014486492828
4	GRAIN TANK UNLOADING	667250.0	1	1001586	4014486484960
5	CHOPPER DRIVE 1ST STAGE	667958.3	1	1001593	4014486485080
6	SIEVE PAN 2ND STAGE	667252.0	1	1003602	4014486485349
7	CHOPPER DRIVE 2ND STAGE	061700.1	1	1003356	4014486486131
8	CHOPPER DRIVE 3RD STAGE RIGID CHOPPER	628888.0	1	1001684	4014486486551
9	CUTTERBAR DRIVE 2ND STAGE WITHOUT VARIABLE SPEED DRIVE	667454.0	2	1002870	4014486472981
10	CUTTERBAR DRIVE 3RD STAGE WITH VARIABLE SPEED DRIVE	667551.1	2	1000867	4014486473056
11	SYNCHRONOUS DRIVE	667249.0	1	1003591	4014486484762
12	CUTTERBAR VARIATOR	667530.1	1	1001163	4014486497441
13	CHAFF SPREADER	746508.1	1	1000266	4014486464252
14	CLEANING 3RD STAGE	667651.0	1	1001706	4014486486834
15	CLEANING - 1ST STAGE	644209.0	1	1000699	4014486470826
15	CLEANING - 1ST STAGE	644209.1	1	1004843	4014486715668
19	FINGER ROLLER	628991.0	1	1000433	4014486467000
22	DRUM VARIATOR	667248.0	1	1001317	4014486497908
23	DRUM DRIVE	176442.0	1	1003641	4014486489033
23	DRUM DRIVE	176442.1	1	1003641	4014486489033
25	FAN DRIVE	746506.0	4	1002784	4014486465716
26	SUCTION FAN	644781.0	1	1000123	4014486461350
27	FAN VARIATOR	667457.0	1	1001079	4014486498233
28	PRE - DRUM DRIVE	667251.1	1	1003601	4014486485219
29	HYDRAULIC REEL DRIVE	829094.0	1	1000245	4014486463712
30	STRAW WALKER DRIVE	667477.0	1	1000387	4014486466508
31	STRAW SPREADER	539443.0	1	No AP	
33	RADIATOR SCREEN 2ND STAGE	545689.0	1	1003332	4014486461886
34	ENGINE C9	796786.0	1	1003220	4014486482478
35	FAN DRIVE C9 EXHAUST LEVEL 3A	584627.1	1	1002652	4014486481259
35	FAN DRIVE ENGINE C10 FROM NO. 58000036	628964.1	1	1002687	4014486482850
35	FAN DRIVE ENGINE C10 TO NO. 58000035	743910.1	1	1003202	4014486482041
35	FAN DRIVE C9 EMISSION STANDARD 2	796450.0	1	1003969	4014486480610
36	SUCTION BLOWER E - CHANNEL	765985.0	1	1002287	4014486479706
	DRUM VARIATOR	667248.1	1	1001317	4014486497908
	CUTTERBAR DRIVE 2ND STAGE WITHOUT VARIABLE SPEED DRIVE	667454.1	2	1002870	4014486472981
	CUTTERBAR DRIVE 3RD STAGE WITH VARIABLE SPEED DRIVE	667551.2	2	1000867	4014486473056
	CHOPPER DRIVE 1ST STAGE	667958.1	1	1003598	4014486485073

## LEXION 560

0	CLEANING - 1ST STAGE	644209.2	1	1004843	4014486715668
0	DRUM DRIVE VARIABLE SPEED	667248.2	1	1001317	4014486497908
0	CUTTERBAR DRIVE - 3RD STAGE WITH VARIABLE SPEED	667551.0	2	1000867	4014486473056
0	CHOPPER DRIVE - 1ST STAGE AT MOTOR C13, C10, C9 AND 3126B	667958.2	1	1003598	4014486485073
0	CHAFF SPREADER DRIVE	746508.3	1	1000266	4014486464252
2	CUTTERBAR DRIVE - 1ST STAGE	644892.0	1	1001860	4014486488968
3	THRESHING MECHANISM ENGINE C9	352403.0	1	1001253	4014486492101
3	THRESHING MECHANISM ENGINE 3126B, C6.6	667453.0	1	1003350	4014486492095
3	THRESHING MECHANISM AT CATERPILLAR C13, C10	667881.0	1	1001320	4014486492828
4	DISCHARGE DRIVE GRAIN TANK	667250.0	1	1001586	4014486484960
5	CHOPPER DRIVE - 1ST STAGE AT MOTOR C6.6	355696.0	1	1004835	4014486717099
5	CHOPPER DRIVE - 1ST STAGE AT MOTOR C13, C10, C9 AND 3126B	667958.3	1	1001593	4014486485080
6	SIEVE PAN DRIVE - 2ND STAGE	667252.0	1	1003602	4014486485349
7	CHOPPER DRIVE - 2ND STAGE	061700.1	1	1003356	4014486486131

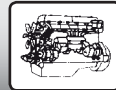

## CLAAS

8	CHOPPER DRIVE - 3RD STAGE RIGID CHOPPER	628888.0	1	1001684	4014486486551
9	CUTTERBAR DRIVE - 2ND WITHOUT VARIABLE SPEED	667454.0	2	1002870	4014486472981
10	CUTTERBAR DRIVE - 3RD STAGE WITH VARIABLE SPEED	667551.1	2	1000867	4014486473056
11	SYNCHRONOUS DRIVE	667249.0	1	1003591	4014486484762
12	CUTTERBAR DRIVE WITH VARIABLE SPEED DRIVE	667530.1	1	1001163	4014486497441
13	CHAFF SPREADER DRIVE	746508.1	1	1000266	4014486464252
14	CLEANING - 3RD STAGE	667651.0	1	1001706	4014486486834
15	CLEANING - 1ST STAGE	644209.0	1	1000699	4014486470826
15	CLEANING - 1ST STAGE	644209.1	1	1004843	4014486715668
19	FINGER ROLLER	628991.0	1	1000433	4014486467000
22	DRUM DRIVE VARIABLE SPEED	667248.0	1	1001317	4014486497908
23	DRUM DRIVE	176442.0	1	1003641	4014486489033
23	DRUM DRIVE	176442.1	1	1003641	4014486489033
25	FAN DRIVE	746506.0	4	1002784	4014486465716
26	SUCTION FAN	644781.0	1	1000123	4014486461350
27	FAN DRIVE VARIABLE SPEED	667457.0	1	1001079	4014486498233
28	PRE-DRUM DRIVE	667251.1	1	1003601	4014486485219
29	HYDRAULIC REEL PUMP DRIVE	829094.0	1	1000245	4014486463712
30	STRAW WALKER DRIVE	667477.0	1	1000387	4014486466508
31	STRAW SPREADER DRIVE	539443.0	1	No AP	
33	RADIATOR SCREEN 2ND STAGE	545689.0	1	1003332	4014486461886
34	ENGINE 3126 B	796474.0	1	1003217	4014486482454
34	ENGINE C9 EMISSION STANDARD 2	796786.0	1	1003220	4014486482478
35	FAN DRIVE AT MOTOR C6.6	580157.0	1	1003786	4014486481334
35	FAN DRIVE C9-EXHAUST LEVEL 3A	584627.1	1	1002652	4014486481259
35	FAN DRIVE - ENGINE C10, C13 (FROM NR. 58401487)	628964.1	1	1002687	4014486482850
35	FAN DRIVE (UP TO NR. 58401486)	743910.1	1	1003202	4014486482041
35	FAN DRIVE - ENGINE 3126B AND AT C9-EMISSION STANDARD	796450.0	1	1003969	4014486480610
36	SUCTION BLOWER E.-CHANNEL	765985.0	1	1002287	4014486479706
	DRUM DRIVE VARIABLE SPEED	667248.1	1	1001317	4014486497908
	CUTTERBAR DRIVE - 2ND WITHOUT VARIABLE SPEED	667454.1	2	1002870	4014486472981
	CUTTERBAR DRIVE - 3RD STAGE WITH VARIABLE SPEED	667551.2	2	1000867	4014486473056
	CHOPPER DRIVE - 1ST STAGE AT MOTOR C13, C10, C9 AND 3126B	667958.1	1	1003598	4014486485073

## LEXION 560 MONTANA

0	CLEANING - 1ST STAGE	644209.2	1	1004843	4014486715668
0	DRUM VARIATOR	667248.2	1	1001317	4014486497908
0	CUTTERBAR DRIVE 3RD STAGE WITH VARIABLE SPEED DRIVE	667551.0	2	1000867	4014486473056
0	CHOPPER DRIVE 1ST STAGE	667958.2	1	1003598	4014486485073
0	CHAFF SPREADER	746508.3	1	1000266	4014486464252
2	CUTTERBAR DRIVE 1ST STAGE	644892.0	1	1001860	4014486488968
3	THRESHING MECHANISM DRIVE ENGINE C9	352403.0	1	1001253	4014486492101
3	THRESHING MECHANISM DRIVE ENGINE C10	667881.0	1	1001320	4014486492828
4	GRAIN TANK UNLOADING	667250.0	1	1001586	4014486484960
5	CHOPPER DRIVE 1ST STAGE	667958.3	1	1001593	4014486485080
6	SIEVE PAN 2ND STAGE	667252.0	1	1003602	4014486485349
7	CHOPPER DRIVE 2ND STAGE	061700.1	1	1003356	4014486486131
8	CHOPPER DRIVE 3RD STAGE RIGID CHOPPER	628888.0	1	1001684	4014486486551
9	CUTTERBAR DRIVE 2ND STAGE WITHOUT VARIABLE SPEED DRIVE	667454.0	2	1002870	4014486472981
10	CUTTERBAR DRIVE 3RD STAGE WITH VARIABLE SPEED DRIVE	667551.1	2	1000867	4014486473056
11	SYNCHRONOUS DRIVE	667249.0	1	1003591	4014486484762
12	CUTTERBAR VARIATOR	667530.1	1	1001163	4014486497441
13	CHAFF SPREADER	746508.1	1	1000266	4014486464252
14	CLEANING 3RD STAGE	667651.0	1	1001706	4014486486834
15	CLEANING - 1ST STAGE	644209.0	1	1000699	4014486470826

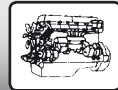

## CLAAS

15	CLEANING - 1ST STAGE	644209.1	1	1004843	4014486715668
19	FINGER ROLLER	628991.0	1	1000433	4014486467000
22	DRUM VARIATOR	667248.0	1	1001317	4014486497908
23	DRUM DRIVE	176442.0	1	1003641	4014486489033
23	DRUM DRIVE	176442.1	1	1003641	4014486489033
25	FAN DRIVE	746506.0	4	1002784	4014486465716
26	SUCTION FAN	644781.0	1	1000123	4014486461350
27	FAN VARIATOR	667457.0	1	1001079	4014486498233
28	PRE - DRUM DRIVE	667251.1	1	1003601	4014486485219
29	HYDRAULIC REEL DRIVE	829094.0	1	1000245	4014486463712
30	STRAW WALKER DRIVE	667477.0	1	1000387	4014486466508
31	STRAW SPREADER	539443.0	1	No AP	
33	RADIATOR SCREEN 2ND STAGE	545689.0	1	1003332	4014486461886
34	ENGINE C9	796786.0	1	1003220	4014486482478
35	FAN DRIVE C9 EXHAUST LEVEL 3A	584627.1	1	1002652	4014486481259
35	FAN DRIVE ENGINE C10 FROM NO. 58000036	628964.1	1	1002687	4014486482850
35	FAN DRIVE ENGINE C10 TO NO. 58000035	743910.1	1	1003202	4014486482041
35	FAN DRIVE C9 EMISSION STANDARD 2	796450.0	1	1003969	4014486480610
36	SUCTION BLOWER E - CHANNEL	765985.0	1	1002287	4014486479706
	DRUM VARIATOR	667248.1	1	1001317	4014486497908
	CUTTERBAR DRIVE 2ND STAGE WITHOUT VARIABLE SPEED DRIVE	667454.1	2	1002870	4014486472981
	CUTTERBAR DRIVE 3RD STAGE WITH VARIABLE SPEED DRIVE	667551.2	2	1000867	4014486473056
	CHOPPER DRIVE 1ST STAGE	667958.1	1	1003598	4014486485073

## LEXION 570

0	CLEANING - 1ST STAGE	644209.2	1	1004843	4014486715668
0	DRUM DRIVE VARIABLE SPEED	667248.2	1	1001317	4014486497908
0	HYBRID VARIABLE SPEED DRIVE (UP TO NR. 58500162)	667248.2	1	1001317	4014486497908
0	CUTTERBAR DRIVE - 3RD STAGE WITH VARIABLE SPEED	667551.0	2	1000867	4014486473056
0	CHOPPER DRIVE - 1ST STAGE	667958.2	1	1003598	4014486485073
0	CHAFF SPREADER DRIVE	746508.3	1	1000266	4014486464252
2	CUTTERBAR DRIVE - 1ST STAGE	644892.0	1	1001860	4014486488968
3	THRESHING MECHANISM DRIVE	667452.1	1	1001302	4014486492606
4	DISCHARGE DRIVE GRAIN TANK	667250.0	1	1001586	4014486484960
5	CHOPPER DRIVE - 1ST STAGE	667958.3	1	1001593	4014486485080
6	SIEVE PAN DRIVE - 2ND STAGE (FROM NR. 58500163-58500093-107)	644902.0	1	1001639	4014486485905
6	TO NR. 58500092 - NR. 58500108-162	667252.0	1	1003602	4014486485349
7	CHOPPER DRIVE - 2ND STAGE	061700.1	1	1003356	4014486486131
8	CHOPPER DRIVE - 3RD STAGE	628978.0	1	1001670	4014486486346
9	CUTTERBAR DRIVE - 2ND STAGE WITHOUT VARIABLE SPEED	667454.0	2	1002870	4014486472981
10	CUTTERBAR DRIVE - 3RD STAGE WITH VARIABLE SPEED	667551.1	2	1000867	4014486473056
11	SYNCHRONOUS DRIVE	667249.0	1	1003591	4014486484762
12	CUTTERBAR DRIVE WITH VARIABLE SPEED DRIVE	667530.1	1	1001163	4014486497441
13	CHAFF SPREADER DRIVE	746508.1	1	1000266	4014486464252
14	CLEANING (TO NR. 58500092 - NR. 58500108-162)	667651.0	1	1001706	4014486486834
14	CLEANING - 3RD STAGE (FROM NR. 58500163-58500093-107)	756466.0	1	1003613	4014486486384
15	CLEANING - 1ST STAGE	644209.0	1	1000699	4014486470826
15	CLEANING - 1ST STAGE	644209.1	1	1004843	4014486715668
16	HYBRID DRIVE - 2ND STAGE (FROM NR. 58500163)	628792.0	1	1001834	4014486488586
16	HYBRID DRIVE - 2ND STAGE (UP TO NR. 58500162)	749895.0	1	1001828	4014486488494
17	HYBRID DRIVE - 1ST STAGE	749886.1	1	1001928	4014486489972
22	DRUM DRIVE VARIABLE SPEED	667248.0	1	1001317	4014486497908
23	DRUM DRIVE	176442.0	1	1003641	4014486489033
23	DRUM DRIVE	176442.1	1	1003641	4014486489033
25	FAN DRIVE (FROM NR. 58500163-NR. 58500093-107)	667957.0	1	1000320	4014486465396

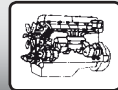

## CLAAS

25	FAN DRIVE (TO NR. 58500092 -NR. 58500108-162)	746506.0	4	1002784	4014486465716
26	SUCTION BLOWER (TO NR. 58500092 -NR. 58500108-162)	644781.0	1	1000123	4014486461350
26	SUCTION BLOWER (FROM NR. 58500163-NR. 58500093-107)	667367.0	1	1002582	4014486495638
27	FAN DRIVE VARIABLE SPEED (TO NR. 58100092 - NR. 58500108-162)	667457.0	1	1001079	4014486498233
27	FAN DRIVE VARIABLE SPEED (FROM NR. 58500163-NR. 58500093-107)	744785.0	1	1000326	4014486465525
28	PRE-DRUM DRIVE	667251.1	1	1003601	4014486485219
29	HYDRAULIC REEL PUMP DRIVE	829094.0	1	1000245	4014486463712
30	STRAW SPREADER DRIVE	539443.0	1	No AP	
31	HYBRID VARIABLE SPEED DRIVE (UP TO NR. 58500162)	667248.0	1	1001317	4014486497908
31	HYBRID DRIVE - 2ND STAGE (FROM NR. 58500163)	744965.0	1	1004897	
32	RADIATOR SCREEN 2ND STAGE	545689.0	1	1003332	4014486461886
34	FAN DRIVE (FROM NR. 58500253)	628964.1	1	1002687	4014486482850
34	FAN DRIVE (UP TO NR. 58500252)	743910.1	1	1003202	4014486482041
35	SUCTION BLOWER E.-CHANNEL	765985.0	1	1002287	4014486479706
36	FROM NR. 58500163-NR. 58500093-107	628847.1	1	1001213	4014486497724
	DRUM DRIVE VARIABLE SPEED	667248.1	1	1001317	4014486497908
	HYBRID VARIABLE SPEED DRIVE (UP TO NR. 58500162)	667248.1	1	1001317	4014486497908
	CUTTERBAR DRIVE - 2ND STAGE WITHOUT VARIABLE SPEED	667454.1	2	1002870	4014486472981
	CUTTERBAR DRIVE - 3RD STAGE WITH VARIABLE SPEED	667551.2	2	1000867	4014486473056
	CHOPPER DRIVE - 1ST STAGE	667958.1	1	1003598	4014486485073

## LEXION 570 MONTANA

0	CLEANING - 1ST STAGE	644209.2	1	1004843	4014486715668
0	DRUM VARIATOR	667248.2	1	1001317	4014486497908
0	FROM NO. 58100038	667248.2	1	1001317	4014486497908
0	CUTTERBAR DRIVE 3RD STAGE WITH VARIABLE SPEED DRIVE	667551.0	2	1000867	4014486473056
0	CHOPPER DRIVE 1ST STAGE	667958.2	1	1003598	4014486485073
0	CHAFF SPREADER	746508.3	1	1000266	4014486464252
2	CUTTERBAR DRIVE, 1ST STAGE	644892.0	1	1001860	4014486488968
3	THRESHING MECHANISM DRIVE	667452.1	1	1001302	4014486492606
4	GRAIN TANK UNLOADING	667250.0	1	1001586	4014486484960
5	CHOPPER DRIVE 1ST STAGE	667958.3	1	1001593	4014486485080
6	SIEVE PAN 2ND STAGE FROM NO. 58100038	644902.0	1	1001639	4014486485905
6	TO NO. 58100037	667252.0	1	1003602	4014486485349
7	CHOPPER DRIVE 2ND STAGE TO NO. 58100186	061700.1	1	1003356	4014486486131
7	CHOPPER DRIVE 2ND STAGE FROM NO. 58100187	644889.0	1	1001658	4014486486148
8	CHOPPER DRIVE 3RD STAGE	628978.0	1	1001670	4014486486346
9	CUTTERBAR DRIVE 2ND STAGE WITHOUT VARIABLE SPEED DRIVE	667454.0	2	1002870	4014486472981
10	CUTTERBAR DRIVE 3RD STAGE WITH VARIABLE SPEED DRIVE	667551.1	2	1000867	4014486473056
11	SYNCHRONOUS DRIVE	667249.0	1	1003591	4014486484762
12	CUTTERBAR VARIATOR	667530.1	1	1001163	4014486497441
13	CHAFF SPREADER	746508.1	1	1000266	4014486464252
14	TO NO. 58100037	667651.0	1	1001706	4014486486834
14	CLEANING, 3RD STAGE FROM NO. 58100038	756466.0	1	1003613	4014486486384
15	CLEANING - 1ST STAGE	644209.0	1	1000699	4014486470826
15	CLEANING - 1ST STAGE	644209.1	1	1004843	4014486715668
16	HYBRID DRIVE 2ND STAGE FROM NO. 58100038	628792.0	1	1001834	4014486488586
16	HYBRID DRIVE 2ND STAGE TO NO. 58100037	749895.0	1	1001828	4014486488494
17	HYBRID DRIVE 1ST FROM NO. 58100038	644961.0	1	1001930	4014486490008
17	TO NO. 58100037	749886.1	1	1001928	4014486489972
22	DRUM VARIATOR	667248.0	1	1001317	4014486497908
23	DRUM DRIVE	176442.0	1	1003641	4014486489033
23	DRUM DRIVE	176442.1	1	1003641	4014486489033
25	FAN DRIVE FROM NO. 58100038	667957.0	1	1000320	4014486465396
25	TO NO. 58100037	746506.0	4	1002784	4014486465716



## CLAAS

26	TO NO. 58100037	644781.0	1	1000123	4014486461350
26	SUCTION BLOWER FROM NO. 58100038	667367.0	1	1002582	4014486495638
27	TO NO. 58100037	667457.0	1	1001079	4014486498233
27	FAN VARIATOR FROM NO. 58100038	744785.0	1	1000326	4014486465525
28	PRE - DRUM DRIVE	667251.1	1	1003601	4014486485219
29	HYDRAULIC REEL DRIVE	829094.0	1	1000245	4014486463712
30	STRAW SPREADER	539443.0	1	No AP	
31	FROM NO. 58100038	667248.0	1	1001317	4014486497908
31	HYBRID DRIVE 2ND STAGE	744965.0	1	1004897	
32	HYBRID VARIABLE SPEED DRIVE TO NO. 58100037	545689.0	1	1003332	4014486461886
34	RADIATOR SCREEN 2ND STAGE	628964.1	1	1002687	4014486482850
34	FAN DRIVE FROM NO. 58100038	743910.1	1	1003202	4014486482041
35	FAN DRIVE TO NO. 58100037	765985.0	1	1002287	4014486479706
36	SUCTION BLOWER E - CHANNEL FROM NO. 58100038	628847.1	1	1001213	4014486497724
	DRUM VARIATOR	667248.1	1	1001317	4014486497908
	FROM NO. 58100038	667248.1	1	1001317	4014486497908
	CUTTERBAR DRIVE 2ND STAGE WITHOUT VARIABLE SPEED DRIVE	667454.1	2	1002870	4014486472981
	CUTTERBAR DRIVE 3RD STAGE WITH VARIABLE SPEED DRIVE	667551.2	2	1000867	4014486473056
	CHOPPER DRIVE 1ST STAGE	667958.1	1	1003598	4014486485073

## LEXION 580

0	CLEANING - 1ST STAGE	644209.2	1	1004843	4014486715668
0	DRUM DRIVE VARIABLE SPEED	667248.2	1	1001317	4014486497908
0	HYBRID VARIABLE SPEED DRIVE (UP TO NR. 58600056)	667248.2	1	1001317	4014486497908
0	CUTTERBAR DRIVE - 3RD STAGE WITH VARIABLE SPEED	667551.0	2	1000867	4014486473056
0	DISCHARGE DRIVE GRAIN TANK	667981.0	1	1001589	4014486485011
0	AT CHAFF-, STRAW- AND RADIAL SPREADER	746508.3	1	1000266	4014486464252
2	CUTTERBAR DRIVE - 1ST STAGE	644892.0	1	1001860	4014486488968
3	THRESHING MECHANISM DRIVE	644884.0	1	1001321	4014486492835
4	DISCHARGE DRIVE GRAIN TANK	667981.2	1	1001588	4014486484991
5	CHOPPER DRIVE - 1ST STAGE	644885.0	1	1001825	4014486488456
6	SIEVE PAN DRIVE - 2ND STAGE	667252.0	1	1003602	4014486485349
7	CHOPPER DRIVE - 2ND STAGE	644889.0	1	1001658	4014486486148
8	CHOPPER DRIVE - 3RD STAGE ONLY FOR RICE	628978.0	1	1001670	4014486486346
8	STRENGTHENED DRIVE	644890.0	1	1001664	4014486486247
9	CUTTERBAR DRIVE - 2ND STAGE WITHOUT VARIABLE SPEED	667454.0	2	1002870	4014486472981
10	CUTTERBAR DRIVE - 3RD STAGE WITH VARIABLE SPEED	667551.1	2	1000867	4014486473056
11	SYNCHRONOUS DRIVE	667249.0	1	1003591	4014486484762
12	CUTTERBAR DRIVE WITH VARIABLE SPEED DRIVE	667530.1	1	1001163	4014486497441
13	AT SPREADER FAN	233843.1	1	1000237	4014486463408
13	AT CHAFF-, STRAW- AND RADIAL SPREADER	746508.1	1	1000266	4014486464252
14	CLEANING - 3RD STAGE	644866.0	1	1003618	4014486486865
15	CLEANING - 1ST STAGE	644209.0	1	1000699	4014486470826
15	CLEANING - 1ST STAGE	644209.1	1	1004843	4014486715668
16	HYBRID DRIVE - 2ND STAGE (FROM NR. 58600057)	628792.0	1	1001834	4014486488586
16	HYBRID DRIVE - 2ND STAGE (UP TO NR. 58600056)	749895.0	1	1001828	4014486488494
17	HYBRID DRIVE - 1ST STAGE	749886.1	1	1001928	4014486489972
18	RADIATOR SCREEN 2ND STAGE	545689.0	1	1003332	4014486461886
19	FAN DRIVE	628964.1	1	1002687	4014486482850
20	ENGINE	744873.0	1	1001338	4014486483543
22	DRUM DRIVE VARIABLE SPEED	667248.0	1	1001317	4014486497908
23	DRUM DRIVE	644965.0	1	1001864	4014486489040
25	FAN DRIVE	746506.0	4	1002784	4014486465716
26	SUCTION FAN	644781.0	1	1000123	4014486461350
27	FAN DRIVE VARIABLE SPEED	667457.0	1	1001079	4014486498233





## CLAAS

28	PRE-DRUM DRIVE	667251.1	1	1003601	4014486485219
29	HYDRAULIC REEL PUMP DRIVE	829094.0	1	1000245	4014486463712
30	STRAW SPREADER DRIVE	539443.0	1	No AP	
31	HYBRID VARIABLE SPEED DRIVE (UP TO NR. 58600056)	667248.0	1	1001317	4014486497908
31	HYBRID VARIABLE SPEED DRIVE (FROM NR. 58600057)	744965.0	1	1004897	
32	SPREADER FAN - 2ND STAGE	667891.1	1	1001012	4014486487947
33	SPREADER FAN - 1ST STAGE (FROM NR. 58600862)	644893.0	1	1001608	4014486485356
33	SPREADER FAN - 1ST STAGE (TO NR. 58600861)	644942.0	1	1001385	4014486475012
34	SUCTION BLOWER E.-CHANNEL	765985.0	1	1002287	4014486479706
35	FEEDER BASE	661425.0	1	1000357	4014486466140
36	FEEDER BASE	758719.0	1	1003405	4014486463309
	DRUM DRIVE VARIABLE SPEED	667248.1	1	1001317	4014486497908
	HYBRID VARIABLE SPEED DRIVE (UP TO NR. 58600056)	667248.1	1	1001317	4014486497908
	CUTTERBAR DRIVE - 2ND STAGE WITHOUT VARIABLE SPEED	667454.1	2	1002870	4014486472981
	CUTTERBAR DRIVE - 3RD STAGE WITH VARIABLE SPEED	667551.2	2	1000867	4014486473056
	DISCHARGE DRIVE GRAIN TANK	667981.1	1	1001589	4014486485011

## LEXION 580 R AUSTRALIA

0	CLEANING - 1ST STAGE	644209.2	1	1004843	4014486715668
0	DRUM VARIATOR	667248.2	1	1001317	4014486497908
0	CUTTERBAR DRIVE 3RD STAGE WITH VARIABLE SPEED DRIVE	667551.0	2	1000867	4014486473056
0	CHOPPER DRIVE 1ST STAGE	667958.2	1	1003598	4014486485073
0	CHAFF SPREADER	746508.3	1	1000266	4014486464252
2	CUTTERBAR DRIVE, 1ST STAGE	644892.0	1	1001860	4014486488968
3	THRESHING MECHANISM DRIVE	667452.1	1	1001302	4014486492606
4	GRAIN TANK UNLOADING	667250.0	1	1001586	4014486484960
5	CHOPPER DRIVE 1ST STAGE	667958.3	1	1001593	4014486485080
6	SIEVE PAN 2ND STAGE	644902.0	1	1001639	4014486485905
7	CHOPPER DRIVE 2ND STAGE	644890.0	1	1001664	4014486486247
8	CHOPPER DRIVE 3RD STAGE	355658.0	1	1001672	4014486486360
9	CUTTERBAR DRIVE 2ND STAGE WITHOUT VARIABLE SPEED DRIVE	667454.0	2	1002870	4014486472981
10	CUTTERBAR DRIVE 3RD STAGE WITH VARIABLE SPEED DRIVE	667551.1	2	1000867	4014486473056
11	SYNCHRONOUS DRIVE	667249.0	1	1003591	4014486484762
12	CUTTERBAR VARIATOR	667530.1	1	1001163	4014486497441
13	CHAFF SPREADER	746508.1	1	1000266	4014486464252
14	CLEANING 3RD STAGE	756466.0	1	1003613	4014486486384
15	CLEANING - 1ST STAGE	644209.0	1	1000699	4014486470826
15	CLEANING - 1ST STAGE	644209.1	1	1004843	4014486715668
16	HYBRID DRIVE 2ND STAGE	628792.0	1	1001834	4014486488586
17	HYBRID DRIVE 1ST STAGE	644961.0	1	1001930	4014486490008
22	DRUM VARIATOR	667248.0	1	1001317	4014486497908
23	DRUM DRIVE	176442.0	1	1003641	4014486489033
23	DRUM DRIVE	176442.1	1	1003641	4014486489033
25	FAN DRIVE 1ST STAGE	667957.0	1	1000320	4014486465396
26	SUCTION FAN	667367.0	1	1002582	4014486495638
27	FAN DRIVE 3RD STAGE	744785.0	1	1000326	4014486465525
28	PRE - DRUM DRIVE	667251.1	1	1003601	4014486485219
29	HYDRAULIC REEL DRIVE	829094.0	1	1000245	4014486463712
30	STRAW SPREADER	539443.0	1	No AP	
31	HYBRID DRIVE, 2ND STAGE	744965.0	1	1004897	
32	RADIATOR SCREEN 2ND STAGE	545689.0	1	1003332	4014486461886
34	FAN DRIVE	628964.1	1	1002687	4014486482850
35	SUCTION BLOWER E - CHANNEL	765985.0	1	1002287	4014486479706
36	FAN VARIABLE SPEED DRIVE 2ND STAGE	628847.1	1	1001213	4014486497724
	DRUM VARIATOR	667248.1	1	1001317	4014486497908



## CLAAS

	CUTTERBAR DRIVE 2ND STAGE WITHOUT VARIABLE SPEED DRIVE	667454.1	2	1002870	4014486472981
	CUTTERBAR DRIVE 3RD STAGE WITH VARIABLE SPEED DRIVE	667551.2	2	1000867	4014486473056
	CHOPPER DRIVE 1ST STAGE	667958.1	1	1003598	4014486485073

### LEXION 600

0	SIEVE PAN DRIVE - 1ST STAGE	644209.2	1	1004843	4014486715668
0	DISCHARGE DRIVE GRAIN TANK - 1ST STAGE	667981.0	1	1001589	4014486485011
0	SUCTION FAN	744874.1	1	1004797	4014486719451
0	AT CHAFF-, STRAW- AND RADIAL SPREADER	746508.3	1	1000266	4014486464252
1	SUCTION BLOWER E.-CHANNEL	765985.0	1	1002287	4014486479706
2	CUTTERBAR DRIVE - 2ND STAGE WITHOUT VARIABLE SPEED	628579.0	3	1000862	4014486472998
3	CUTTERBAR DRIVE - 3RD STAGE WITH VARIABLE SPEED	628779.0	3	1002871	4014486473063
4	CUTTERBAR DRIVE - 2ND STAGE WITH VARIABLE SPEED	744870.0	1	No AP	
5	IMPELLER DRUM DRIVE	667249.0	1	1003591	4014486484762
6	HYDRAULIC REEL PUMP DRIVE	829094.0	1	1000245	4014486463712
7	CUTTERBAR DRIVE - 1ST STAGE B06 / 10 - STANDARD	644892.0	1	1001860	4014486488968
7	CUTTERBAR DRIVE - 1ST STAGE B06 / 20 - VARIATOR	749859.0	1	1001974	4014486490916
8	AT CHAFF-, STRAW- AND RADIAL SPREADER	746508.1	1	1000266	4014486464252
9	THRESHING MECHANISM DRIVE	644884.0	1	1001321	4014486492835
10	DISCHARGE DRIVE GRAIN TANK - 1ST STAGE	667981.2	1	1001588	4014486484991
12	CHOPPER DRIVE - 1ST STAGE	644885.0	1	1001825	4014486488456
13	CHOPPER DRIVE - 2ND STAGE	644889.0	1	1001658	4014486486148
14	CHOPPER DRIVE - 3RD STAGE ONLY FOR RICE	628978.0	1	1001670	4014486486346
17	STRAW SPREADER DRIVE	539443.0	1	No AP	
18	SIEVE PAN DRIVE - 1ST STAGE	644209.0	1	1000699	4014486470826
18	SIEVE PAN DRIVE - 1ST STAGE	644209.1	1	1004843	4014486715668
19	SIEVE PAN DRIVE - 2ND STAGE	644902.0	1	1001639	4014486485905
21	SIEVE PAN DRIVE 2RD STAGE	756466.0	1	1003613	4014486486384
40	HYBRID DRIVE - 2ND STAGE	628792.0	1	1001834	4014486488586
41	HYBRID VARIABLE SPEED - 2ND STAGE	744965.0	1	1004897	
42	HYBRID DRIVE - 1ST STAGE	749886.1	1	1001928	4014486489972
47	FAN DRIVE - 1ST STAGE	667957.0	1	1000320	4014486465396
49	BLOWER VARIABLE SPEED - 2ND STAGE	628847.1	1	1001213	4014486497724
50	FAN DRIVE - 3RD STAGE	744785.0	1	1000326	4014486465525
52	THRESHING MECHANISM DRIVE	744965.0	1	1004897	
53	DRUM DRIVE	644965.0	1	1001864	4014486489040
54	PRE-DRUM DRIVE	667251.1	1	1003601	4014486485219
60	ENGINE	744873.0	1	1001338	4014486483543
61	FAN DRIVE	628964.1	1	1002687	4014486482850
63	SUCTION FAN	744874.0	1	1000088	4014486460858
	CUTTERBAR DRIVE - 2ND STAGE WITHOUT VARIABLE SPEED	628579.1	3	1000862	4014486472998
	CUTTERBAR DRIVE - 3RD STAGE WITH VARIABLE SPEED	628779.1	3	1002871	4014486473063
	DISCHARGE DRIVE GRAIN TANK - 1ST STAGE	667981.1	1	1001589	4014486485011

### MATADOR - GIGANT

0	HYDRAULIC PUMP DRIVE	767057.1	1	1003333	4014486462609
1	TURNING DRUM DRIVE	610197.0	1	1000903	4014486473490
2	TURNING DRUM DRIVE	500863.0	1	1000902	4014486473483
3	COUNTERSHAFT - BALER	551068.0	1	1000925	4014486473759
4	MAIN DRIVE	630144.0	1	1000965	4014486474244
5	RADIATOR FAN DRIVE	610196.0	1	1001029	4014486496284
5	RADIATOR FAN DRIVE	610835.0	1	1001031	4014486496307
5	RADIATOR FAN DRIVE	653121.0	1	1001030	4014486496291
6	KNIFE DRIVE	610833.0	2	1002788	4014486466201
9		630025.0	1	No AP	

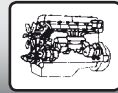

## CLAAS

10	HYDRAULIC PUMP DRIVE	767057.0	1	1003333	4014486462609
11	SIEVE BOX	772658.0	1	1000935	4014486473865
12	REEL DRIVE VARIABLE SPEED	778561.0	1	1001038	4014486496376
13	PICK UP DRIVE	800309.0	1	1003435	4014486464719
14	DRIVE GRAIN TANK	636021.0	1	1000882	4014486473223
14	DRIVE GRAIN TANK	636021.1	1	1000883	4014486473230
15	TRACTION DRIVE	630156.0	1	1000980	4014486474404
16	DRUM DRIVE VARIABLE SPEED	750294.0	1	1000251	4014486463897
17	STRAW SHAKER	801222.0	4	1002798	4014486465808
	KNIFE DRIVE	610833.1	2	1002788	4014486466201

## MATADOR - STANDARD

0	HYDRAULIC PUMP DRIVE	767057.1	1	1003333	4014486462609
1	TURNING DRUM DRIVE	610197.0	1	1000903	4014486473490
2	TURNING DRUM DRIVE	500863.0	1	1000902	4014486473483
3	COUNTERSHAFT - BALER	551068.0	1	1000925	4014486473759
4	MAIN DRIVE	630144.0	1	1000965	4014486474244
5	RADIATOR FAN DRIVE	610196.0	1	1001029	4014486496284
5	RADIATOR FAN DRIVE	610835.0	1	1001031	4014486496307
5	RADIATOR FAN DRIVE	653121.0	1	1001030	4014486496291
6	KNIFE DRIVE	610833.0	2	1002788	4014486466201
9		630025.0	1	No AP	
10	HYDRAULIC PUMP DRIVE	767057.0	1	1003333	4014486462609
11	SIEVE BOX	772658.0	1	1000935	4014486473865
12	REEL DRIVE VARIABLE SPEED	778561.0	1	1001038	4014486496376
13	PICK UP DRIVE	800309.0	1	1003435	4014486464719
14	DRIVE GRAIN TANK	636021.0	1	1000882	4014486473223
14	DRIVE GRAIN TANK	636021.1	1	1000883	4014486473230
15	TRACTION DRIVE	630156.0	1	1000980	4014486474404
16	DRUM DRIVE VARIABLE SPEED	750294.0	1	1000251	4014486463897
17	STRAW SHAKER	801222.0	4	1002798	4014486465808
	KNIFE DRIVE	610833.1	2	1002788	4014486466201

## MEDION 310

0		056961.0	1	1000117	4014486461268
0		506671.0	1	1000506	4014486467840
0		506671.1	1	1000506	4014486467840
0		603017.0	2	1000833	4014486472592
0		755070.0	2	1002795	4014486463279
0		755070.2	2	1002795	4014486463279
1		644016.1	1	1001800	4014486488104
2		656028.0	1	1003335	4014486462869
3		621903.0	1	1002041	4014486475166
3		621903.1	1	1002041	4014486475166
4		660409.0	1	1001575	4014486484809
6		603337.0	1	1000662	4014486470260
7		603336.0	1	1000478	4014486467499
7		603336.1	1	1000478	4014486467499
9		623427.1	1	1000409	4014486466720
10		755070.1	2	1002795	4014486463279
13		061214.0	1	1000868	4014486473070
13		061353.0	1	1000870	4014486473094
13		061353.1	1	1000870	4014486473094
14		671209.0	1	1001039	4014486496383
15		603017.3	2	1000833	4014486472592



## CLAAS

19		506671.2	1	1000506	4014486467840
20		545689.0	1	1003332	4014486461886
22		644448.0	1	1000139	4014486461565
23		609823.0	1	1001225	4014486497809
24		661220.0	1	1003340	4014486488807
24		661220.1	1	1003340	4014486488807
26		661429.0	1	1001212	4014486497717
		603017.2	2	1000833	4014486472592

### MEDION 320

0		056961.0	1	1000117	4014486461268
0		506671.0	1	1000506	4014486467840
0		506671.1	1	1000506	4014486467840
0		603017.0	2	1000833	4014486472592
0		755070.0	2	1002795	4014486463279
0		755070.2	2	1002795	4014486463279
1		644016.1	1	1001800	4014486488104
2		656028.0	1	1003335	4014486462869
3		621903.0	1	1002041	4014486475166
3		621903.1	1	1002041	4014486475166
4		660409.0	1	1001575	4014486484809
6		603337.0	1	1000662	4014486470260
7		603336.0	1	1000478	4014486467499
7		603336.1	1	1000478	4014486467499
9		623427.1	1	1000409	4014486466720
10		755070.1	2	1002795	4014486463279
13		061214.0	1	1000868	4014486473070
13		061353.0	1	1000870	4014486473094
13		061353.1	1	1000870	4014486473094
14		671209.0	1	1001039	4014486496383
15		603017.3	2	1000833	4014486472592
19		506671.2	1	1000506	4014486467840
20		545689.0	1	1003332	4014486461886
22		644448.0	1	1000139	4014486461565
23		609823.0	1	1001225	4014486497809
24		661220.0	1	1003340	4014486488807
24		661220.1	1	1003340	4014486488807
26		661429.0	1	1001212	4014486497717
		603017.2	2	1000833	4014486472592

### MEDION 320/310

0		506671.0	1	1000506	4014486467840
0		506671.1	1	1000506	4014486467840
0		506671.2	1	1000506	4014486467840

### MEDION 330

0		056961.0	1	1000117	4014486461268
0	N = 519 MIN-1	066034.0	1	1000302	4014486465037
0		506671.0	1	1000506	4014486467840
0		506671.1	1	1000506	4014486467840
0	ALTERNATOR TILL NR. 932002271	545954.0	1	1002646	4014486480849
0		603017.0	2	1000833	4014486472592
0		755070.0	2	1002795	4014486463279
0		755070.2	2	1002795	4014486463279
0	ALTERNATOR FROM NO. 93202272	796998.0	1	1003945	4014486481969

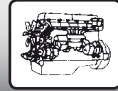

## CLAAS

1		644016.1	1	1001800	4014486488104
2		656028.0	1	1003335	4014486462869
3		621903.0	1	1002041	4014486475166
3		621903.1	1	1002041	4014486475166
4	WITH MERCEDES OM 906 LA	544166.0	1	1003360	4014486484830
4	WITH PERKINS 1006-6 TA	660409.0	1	1001575	4014486484809
5	WITH PERKINS 1006-6 TA	544114.1	1	1001846	4014486488760
5	WITH MERCEDES OM 906 LA	544164.0	1	1001969	4014486490800
6		603337.0	1	1000662	4014486470260
7		603336.0	1	1000478	4014486467499
7		603336.1	1	1000478	4014486467499
8		644447.0	1	1000420	4014486466836
9		623427.1	1	1000409	4014486466720
10		755070.1	2	1002795	4014486463279
11	N = 660 MIN-1	785341.0	1	1000295	4014486464870
12		661301.0	2	1000840	4014486472684
12		661301.1	2	1000840	4014486472684
13	FOR CORN	061214.0	1	1000868	4014486473070
13		061353.0	1	1000870	4014486473094
13		061353.1	1	1000870	4014486473094
14		671209.0	1	1001039	4014486496383
15		603017.3	2	1000833	4014486472592
17		544147.0	1	1000727	4014486471199
19		506671.2	1	1000506	4014486467840
20	TO NO. 93202271	545689.0	1	1003332	4014486461886
20	FROM NO. 93202272	821734.2	1	1000154	4014486461763
22		644448.0	1	1000139	4014486461565
23		661427.0	1	1001228	4014486497847
24	DRUM VARIABLE SPEED DRIVE	661220.0	1	1003340	4014486488807
24	DRUM VARIABLE SPEED DRIVE	661220.1	1	1003340	4014486488807
26	DIRECT DRIVE	661429.0	1	1001212	4014486497717
		603017.2	2	1000833	4014486472592

## MEDION 330 HYDRO

0	STRAW WALKER DRIVE	506671.0	1	1000506	4014486467840
0	STRAW WALKER DRIVE	506671.1	1	1000506	4014486467840
0	ALTERNATOR FROM NR. 93100213	545954.0	1	1002646	4014486480849
0	SIEVE PAN, 3RD STAGE	603017.0	2	1000833	4014486472592
0	ALTERNATOR FROM NO. 93100214	796998.0	1	1003945	4014486481969
1	HYDRAULIC GROUND DRIVE	644016.1	1	1001800	4014486488104
2	GEAR PUMP	656028.0	1	1003335	4014486462869
3	AIR CONDITIONER	621903.0	1	1002041	4014486475166
3	AIR CONDITIONER	621903.1	1	1002041	4014486475166
4	GRAIN TANK UNLOADING	544166.0	1	1003360	4014486484830
5	THRESHING MECHANISM DRIVE	544164.0	1	1001969	4014486490800
6	SIEVE PAN, 1ST STAGE	603337.0	1	1000662	4014486470260
7	SIEVE PAN, 2ND STAGE	603336.0	1	1000478	4014486467499
7	SIEVE PAN, 2ND STAGE	603336.1	1	1000478	4014486467499
8	INTENSIVE SEPARATION SYSTEM	644447.0	1	1000420	4014486466836
12		644419.0	2	1000832	4014486472585
13	CHOPPER DRIVE 2ND STAGE	061353.0	1	1000870	4014486473094
13	CHOPPER DRIVE 2ND STAGE	061353.1	1	1000870	4014486473094
14	FAN VARIATOR	671209.0	1	1001039	4014486496383
15	SIEVE PAN, 3RD STAGE	603017.3	2	1000833	4014486472592
17	CHOPPER DRIVE 1ST STAGE	544147.0	1	1000727	4014486471199

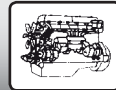
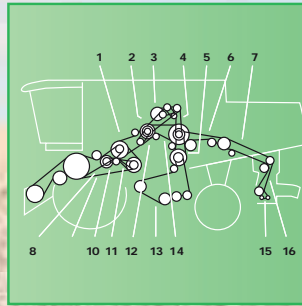
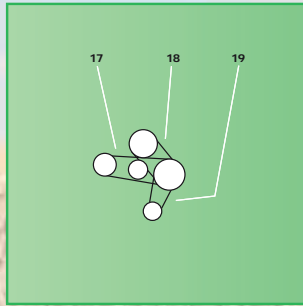
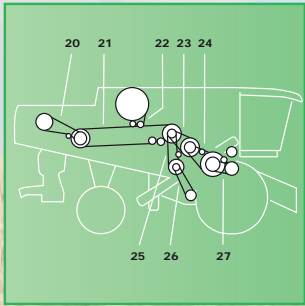

## CLAAS

19	STRAW WALKER DRIVE	506671.2	1	1000506	4014486467840
20	RADIATOR SCREEN 2ND STAGE TO NO. 93100143	545689.0	1	1003332	4014486461886
20	RADIATOR SCREEN 2ND STAGE FROM NO. 93100144	821734.2	1	1000154	4014486461763
22	RADIATOR SCREEN SUCTION BLOWER	644448.0	1	1000139	4014486461565
26	DIRECT DRIVE DRUM VARIABLE SPEED DRIVE 650 - 1500 RPM	661429.0	1	1001212	4014486497717
	SIEVE PAN, 3RD STAGE	603017.2	2	1000833	4014486472592
		644419.1	2	1000832	4014486472585

## MEDION 340

0		506671.0	1	1000506	4014486467840
0		506671.1	1	1000506	4014486467840
0		755070.0	2	1002795	4014486463279
0		755070.2	2	1002795	4014486463279
2		656028.0	1	1003335	4014486462869
3		621903.0	1	1002041	4014486475166
3		621903.1	1	1002041	4014486475166
4		544166.0	1	1003360	4014486484830
5		544164.0	1	1001969	4014486490800
6		603337.0	1	1000662	4014486470260
7		644141.1	1	1000476	4014486467475
9		623427.1	1	1000409	4014486466720
10		755070.1	2	1002795	4014486463279
13		061214.0	1	1000868	4014486473070
14		603380.1	1	1001080	4014486498240
15		609762.0	1	1001713	4014486486919
19		506671.2	1	1000506	4014486467840
23		609823.0	1	1001225	4014486497809
24		661220.0	1	1003340	4014486488807
24		661220.1	1	1003340	4014486488807

## MERCATOR 50

0	STRAW WALKER DRIVE	755070.1	2	1002795	4014486463279
0	STRAW WALKER DRIVE	755070.2	2	1002795	4014486463279
1	MAIN DRIVE	653060.0	1	1003653	4014486489514
2	HYDRAULIC PUMP DRIVE	656028.0	1	1003335	4014486462869
3	MAIN DRIVE	630144.0	1	1000965	4014486474244
3	MAIN DRIVE	653059.0	1	1000960	4014486474183
3	MAIN DRIVE	653062.0	1	1000964	4014486474220
3	MAIN DRIVE	653064.0	1	1000968	4014486474275
4	REEL DRIVE VARIABLE SPEED	778561.0	1	1001038	4014486496376
5	KNIFE DRIVE	610830.0	2	1002789	4014486466249
5	KNIFE DRIVE	610833.0	2	1002788	4014486466201
6	CUTTING TABLE DRIVE	653063.0	1	1003572	4014486497045
8	FANNING MILL	653121.0	1	1001030	4014486496291
9	SHAKER SHOE DRIVE	653120.0	1	1000929	4014486473797
10	DRIVE GRAIN TANK	634019.0	2	1002792	4014486464368
10	DRIVE GRAIN TANK	634019.1	2	1002792	4014486464368
10	DRIVE GRAIN TANK	634019.2	2	1002792	4014486464368
10	DRIVE GRAIN TANK	653450.0	1	1002137	4014486476491
11	STRAW WALKER DRIVE	653933.0	1	1002119	4014486476200
11	STRAW WALKER DRIVE	755070.0	2	1002795	4014486463279
12	TURNING DRUM DRIVE	750294.0	1	1000251	4014486463897
13	TANK UNLOADER DRIVE	653779.0	1	1000909	4014486473551
14	TRACTION DRIVE	655408.0	1	1001527	4014486460469
	KNIFE DRIVE	610830.1	2	1002789	4014486466249

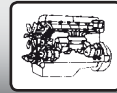
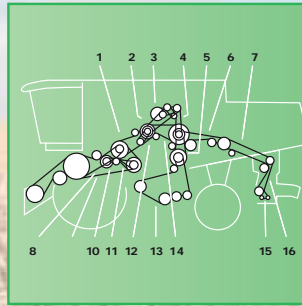
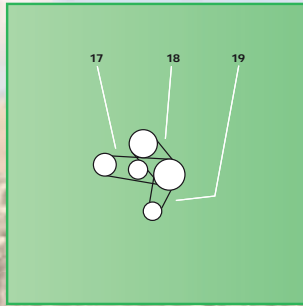
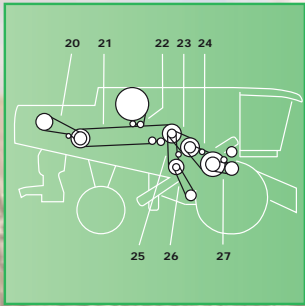

# CLAAS

KNIFE DRIVE		610833.1	2	1002788	4014486466201
<b>MERCATOR 60</b>					
0	STRAW WALKER DRIVE	755070.1	2	1002795	4014486463279
0	STRAW WALKER DRIVE	755070.2	2	1002795	4014486463279
1	MAIN DRIVE	653060.0	1	1003653	4014486489514
2	HYDRAULIC PUMP DRIVE	656028.0	1	1003335	4014486462869
3	MAIN DRIVE	630144.0	1	1000965	4014486474244
3	MAIN DRIVE	653059.0	1	1000960	4014486474183
3	MAIN DRIVE	653062.0	1	1000964	4014486474220
3	MAIN DRIVE	653064.0	1	1000968	4014486474275
4	REEL DRIVE VARIABLE SPEED	778561.0	1	1001038	4014486496376
5	KNIFE DRIVE	610830.0	2	1002789	4014486466249
5	KNIFE DRIVE	610833.0	2	1002788	4014486466201
6	CUTTING TABLE DRIVE	653063.0	1	1003572	4014486497045
8	FANNING MILL	653121.0	1	1001030	4014486496291
9	SHAKER SHOE DRIVE	653120.0	1	1000929	4014486473797
10	DRIVE GRAIN TANK	634019.0	2	1002792	4014486464368
10	DRIVE GRAIN TANK	634019.1	2	1002792	4014486464368
10	DRIVE GRAIN TANK	634019.2	2	1002792	4014486464368
10	DRIVE GRAIN TANK	653450.0	1	1002137	4014486476491
11	STRAW WALKER DRIVE	653933.0	1	1002119	4014486476200
11	STRAW WALKER DRIVE	755070.0	2	1002795	4014486463279
12	TURNING DRUM DRIVE	750294.0	1	1000251	4014486463897
13	TANK UNLOADER DRIVE	653779.0	1	1000909	4014486473551
14	TRACTION DRIVE	655408.0	1	1001527	4014486460469
	KNIFE DRIVE	610830.1	2	1002789	4014486466249
	KNIFE DRIVE	610833.1	2	1002788	4014486466201

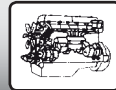
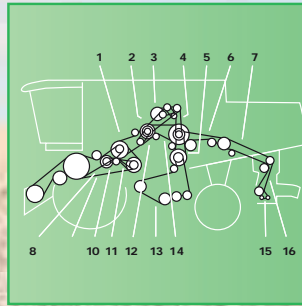
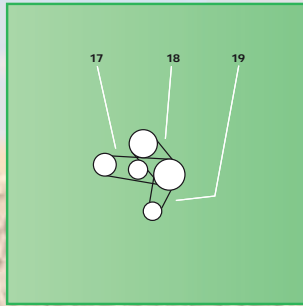
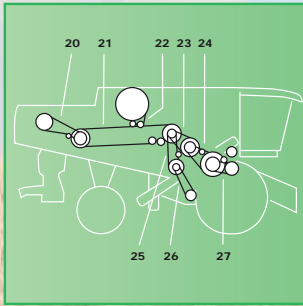

# CLAAS

## MERCATOR 75

0	STRAW WALKER DRIVE	755070.1	2	1002795	4014486463279
0	STRAW WALKER DRIVE	755070.2	2	1002795	4014486463279
1	MAIN DRIVE	653060.0	1	1003653	4014486489514
2	HYDRAULIC PUMP DRIVE	656028.0	1	1003335	4014486462869
3	MAIN DRIVE	630144.0	1	1000965	4014486474244
3	MAIN DRIVE	653059.0	1	1000960	4014486474183
3	MAIN DRIVE	653062.0	1	1000964	4014486474220
3	MAIN DRIVE	653064.0	1	1000968	4014486474275
4	REEL DRIVE VARIABLE SPEED	778561.0	1	1001038	4014486496376
5	KNIFE DRIVE	610830.0	2	1002789	4014486466249
5	KNIFE DRIVE	610833.0	2	1002788	4014486466201
6	CUTTING TABLE DRIVE	653063.0	1	1003572	4014486497045
8	FANNING MILL	653380.0	1	1001032	4014486496314
9	SHAKER SHOE DRIVE	653120.0	1	1000929	4014486473797
10	DRIVE GRAIN TANK	634019.0	2	1002792	4014486464368
10	DRIVE GRAIN TANK	634019.1	2	1002792	4014486464368
10	DRIVE GRAIN TANK	634019.2	2	1002792	4014486464368
10	DRIVE GRAIN TANK	653450.0	1	1002137	4014486476491
11	TURNING DRUM DRIVE	750294.0	1	1000251	4014486463897
12	STRAW WALKER DRIVE	653933.0	1	1002119	4014486476200
12	STRAW WALKER DRIVE	755070.0	2	1002795	4014486463279
13	TANK UNLOADER DRIVE	654534.0	1	1000913	4014486473629
14	TRACTION DRIVE	655408.0	1	1001527	4014486460469
15	SHAKER SHAFT DRIVE	687046.0	1	1003448	4014486465495
	KNIFE DRIVE	610830.1	2	1002789	4014486466249
	KNIFE DRIVE	610833.1	2	1002788	4014486466201
	FANNING MILL	653380.1	1	1001032	4014486496314
	SHAKER SHAFT DRIVE	687046.1	1	1000323	4014486465471

## MERCATOR S 70

0	STRAW WALKER DRIVE	755070.1	2	1002795	4014486463279
0	STRAW WALKER DRIVE	755070.2	2	1002795	4014486463279
1	MAIN DRIVE	653060.0	1	1003653	4014486489514
2	HYDRAULIC PUMP DRIVE	656028.0	1	1003335	4014486462869
3	MAIN DRIVE	630144.0	1	1000965	4014486474244
3	MAIN DRIVE	653059.0	1	1000960	4014486474183
3	MAIN DRIVE	653062.0	1	1000964	4014486474220
3	MAIN DRIVE	653064.0	1	1000968	4014486474275
4	REEL DRIVE VARIABLE SPEED	778561.0	1	1001038	4014486496376
5	KNIFE DRIVE	610830.0	2	1002789	4014486466249
5	KNIFE DRIVE	610833.0	2	1002788	4014486466201
6	CUTTING TABLE DRIVE	653063.0	1	1003572	4014486497045
8	FANNING MILL	653380.0	1	1001032	4014486496314
9	SHAKER SHOE DRIVE	653120.0	1	1000929	4014486473797
10	DRIVE GRAIN TANK	634019.0	2	1002792	4014486464368
10	DRIVE GRAIN TANK	634019.1	2	1002792	4014486464368
10	DRIVE GRAIN TANK	634019.2	2	1002792	4014486464368
10	DRIVE GRAIN TANK	653450.0	1	1002137	4014486476491
11	TURNING DRUM DRIVE	750294.0	1	1000251	4014486463897
12	STRAW WALKER DRIVE	653933.0	1	1002119	4014486476200
12	STRAW WALKER DRIVE	755070.0	2	1002795	4014486463279
13	TANK UNLOADER DRIVE	654534.0	1	1000913	4014486473629
14	TRACTION DRIVE	655408.0	1	1001527	4014486460469





## CLAAS

15	SHAKER SHAFT DRIVE	687046.0	1	1003448	4014486465495
	KNIFE DRIVE	610830.1	2	1002789	4014486466249
	KNIFE DRIVE	610833.1	2	1002788	4014486466201
	FANNING MILL	653380.1	1	1001032	4014486496314
	SHAKER SHAFT DRIVE	687046.1	1	1000323	4014486465471

### MERCUR

0	RADIATOR FAN DRIVE	758662.1	1	1000240	4014486463484
0		773313.0	1	1000480	4014486467512
0	KNIFE DRIVE	778717.1	2	1004307	4014486714937
1	BALER	500863.0	1	1000902	4014486473483
2	RADIATOR FAN DRIVE	758662.0	1	1000240	4014486463484
2	RADIATOR FAN DRIVE	758719.0	1	1003405	4014486463309
3	KNIFE DRIVE	770214.0	1	1003560	4014486473391
3	KNIFE DRIVE	778717.0	2	1004307	4014486714937
4	SPREADER GRAIN IN TANK	775698.0	1	1000272	4014486464429
5	REEL DRIVE VARIABLE SPEED	778561.0	1	1001038	4014486496376
7	CUTTING TABLE DRIVE	779214.0	1	1000452	4014486467215
7	CUTTING TABLE DRIVE	779272.0	1	1000459	4014486467284
8	TANK UNLOADER DRIVE	780419.0	1	1003559	4014486473254
9	PICK UP DRIVE	800309.0	1	1003435	4014486464719
10	STRAW CHOPPER DRIVE	551190.0	1	1000933	4014486473841
11	TRACTION VARIATOR DRIVE	751112.0	1	1001161	4014486497427
13	TRACTION DRIVE	758853.0	1	1000456	4014486467253
14	THRESHING MACHINE	758854.0	1	1000449	4014486467161
16	SHAKER SHOE FAN ELEVATOR - BALER	779212.0	1	1000486	4014486467574
17	SHAKER SHOE FAN ELEVATOR	779213.0	1	1000482	4014486467536

### OLDER MODELS

0	FAN DRIVE	505143.1	1	1000513	4014486467925
0	HYDRAULIC PUMP DRIVE	633030.2	1	1000220	4014486462838
1	FAN DRIVE	505143.0	1	1000513	4014486467925
2	BALER	506023.0	1	1000928	4014486473780
3	GOVERNOR DRIVE	624131.0	1	1000194	4014486462289
4	HYDRAULIC PUMP DRIVE	633030.0	1	1000220	4014486462838
5	SIEVE BOX	634019.0	2	1002792	4014486464368
5	SIEVE BOX	634019.1	2	1002792	4014486464368
5	SIEVE BOX	634019.2	2	1002792	4014486464368
6	STRAW WALKER DRIVE	501925.0	1	1003449	4014486465501
7	MAIN DRIVE FLAT BELT	630025.0	1	No AP	
8	CYLINDER	503969.0	1	1000956	4014486520293
9	PICK UP DRIVE	507020.0	2	1002788	4014486466201
	HYDRAULIC PUMP DRIVE	633030.1	1	1000220	4014486462838

### PROTECTOR

0	SHAKER SHOE DRIVE	653120.0	1	1000929	4014486473797
1	KNIFE DRIVE	610830.0	2	1002789	4014486466249
1	KNIFE DRIVE	610833.0	2	1002788	4014486466201
3	MAIN DRIVE	630144.0	1	1000965	4014486474244
3	MAIN DRIVE	653059.0	1	1000960	4014486474183
3	MAIN DRIVE	653062.0	1	1000964	4014486474220
3	MAIN DRIVE	653064.0	1	1000968	4014486474275
4	CYLINDER DRIVE	653060.0	1	1003653	4014486489514
5	CUTTING TABLE DRIVE	653063.0	1	1003572	4014486497045
7	FANNING MILL	653121.0	1	1001030	4014486496291



## CLAAS

8	SHAKER SHOE DRIVE	653450.0	1	1002137	4014486476491
9	HYDRAULIC PUMP DRIVE	656028.0	1	1003335	4014486462869
10	REEL DRIVE VARIABLE SPEED	778561.0	1	1001038	4014486496376
11	TANK UNLOADER DRIVE	653779.0	1	1000909	4014486473551
12	STRAW WALKER DRIVE	653933.0	1	1002119	4014486476200
13	TRACTION DRIVE	655408.0	1	1001527	4014486460469
14	TURNING DRUM DRIVE	750294.0	1	1000251	4014486463897
	KNIFE DRIVE	610830.1	2	1002789	4014486466249
	KNIFE DRIVE	610833.1	2	1002788	4014486466201

## RAPS DOMINATOR

0		509206.0	1	1000519	4014486467994
---	--	----------	---	---------	---------------

## SENATOR

0	HYDRAULIC PUMP DRIVE	633030.2	1	1000220	4014486462838
0	SHAKER SHOE DRIVE	653120.0	1	1000929	4014486473797
1	KNIFE DRIVE	610830.0	2	1002789	4014486466249
1	KNIFE DRIVE	610833.0	2	1002788	4014486466201
3	MAIN DRIVE	630144.0	1	1000965	4014486474244
3	MAIN DRIVE	653059.0	1	1000960	4014486474183
3	MAIN DRIVE	653062.0	1	1000964	4014486474220
3	MAIN DRIVE	653064.0	1	1000968	4014486474275
4	HYDRAULIC PUMP DRIVE	633030.0	1	1000220	4014486462838
5	CYLINDER	653060.0	1	1003653	4014486489514
6	CUTTING TABLE DRIVE	653063.0	1	1003572	4014486497045
8	FANNING MILL	653121.0	1	1001030	4014486496291
8	FANNING MILL	653380.0	1	1001032	4014486496314
9	REEL DRIVE VARIABLE SPEED	778561.0	1	1001038	4014486496376
10	TRACTION DRIVE	631904.0	1	1001162	4014486497434
10	TRACTION DRIVE	655408.0	1	1001527	4014486460469
11	TANK UNLOADER DRIVE	654013.0	1	1002233	4014486477955
12	TURNING DRUM DRIVE	750294.0	1	1000251	4014486463897
13	STRAW WALKER DRIVE	653933.0	1	1002119	4014486476200
13	STRAW WALKER DRIVE	801222.0	4	1002798	4014486465808
	KNIFE DRIVE	610830.1	2	1002789	4014486466249
	KNIFE DRIVE	610833.1	2	1002788	4014486466201
	HYDRAULIC PUMP DRIVE	633030.1	1	1000220	4014486462838
	FANNING MILL	653380.1	1	1001032	4014486496314

## SF

0	HYDRAULIC PUMP DRIVE	633030.2	1	1000220	4014486462838
1	DRIVE GRAIN TANK	636021.0	1	1000882	4014486473223
2	DRIVE GRAIN TANK	636021.1	1	1000883	4014486473230
3	ENGINE	624131.0	1	1000194	4014486462289
4	HYDRAULIC PUMP DRIVE	633030.0	1	1000220	4014486462838
5	STRAW SHAKER	618123.0	1	1003434	4014486464634
6	CUTTING TABLE DRIVE	610197.0	1	1000903	4014486473490
8	MAIN DRIVE	630144.0	1	1000965	4014486474244
9	TRACTION DRIVE	630156.0	1	1000980	4014486474404
11	MAIN DRIVE FLAT BELT	630025.0	1	No AP	
12	MAIN DRIVE	630118.0	1	1000959	4014486474169
	HYDRAULIC PUMP DRIVE	633030.1	1	1000220	4014486462838



# CLAAS

## TUCANO 330/320

1		554017.0	2	1003974	4014486472790
3		549099.0	1	1003966	4014486491708
4		667251.1	1	1003601	4014486485219
5		603247.1	1	1003626	4014486488111
6		603337.0	1	1000662	4014486470260
7		644362.0	1	1001077	4014486498219
8		644267.0	1	1000243	4014486463613
9		644141.1	1	1000476	4014486467475
10		609762.0	1	1001713	4014486486919
11		506671.2	1	1000506	4014486467840
12		644447.0	1	1000420	4014486466836
13		544216.0	1	1003967	4014486465938
13		544216.1	1	1003967	4014486465938
14		629402.0	1	1000409	4014486466720
15		633030.2	1	1000220	4014486462838
40		544172.0	1	1001745	4014486487299
41		061700.1	1	1003356	4014486486131
42		661427.0	1	1001228	4014486497847
43		661220.0	1	1003340	4014486488807
43		661220.1	1	1003340	4014486488807
44		661429.0	1	1001212	4014486497717
45		077276.0	1	1000177	4014486462067
46		799181.0	1	1003970	4014486481808
47		549752.0	2	1002745	4014486460957

## TUCANO 340

1		554017.0	2	1003974	4014486472790
3		549099.0	1	1003966	4014486491708
4		667251.1	1	1003601	4014486485219
5		544049.1	2	1001561	4014486484618
6		603337.0	1	1000662	4014486470260
7		644362.0	1	1001077	4014486498219
8		538714.0	1	1003403	4014486463194
9		644141.1	1	1000476	4014486467475
10		609762.0	1	1001713	4014486486919
11		506671.2	1	1000506	4014486467840
12		644447.0	1	1000420	4014486466836
13		544216.0	1	1003967	4014486465938
13		544216.1	1	1003967	4014486465938
14		629402.0	1	1000409	4014486466720
15		633030.2	1	1000220	4014486462838
40		544172.0	1	1001745	4014486487299
41		061700.1	1	1003356	4014486486131
42		661427.0	1	1001228	4014486497847
43		661220.0	1	1003340	4014486488807
43		661220.1	1	1003340	4014486488807
44		661429.0	1	1001212	4014486497717
45		077276.0	1	1000177	4014486462067
46		799181.0	1	1003970	4014486481808
47		549752.0	2	1002745	4014486460957

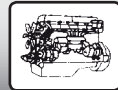

# CLAAS

## TUCANO 430

1		549055.0	2	1003968	4014486520309
1		549055.1	2	1003968	4014486520309
2		661031.1	1	1001564	4014486484663
3		549099.0	1	1003966	4014486491708
4		667251.1	1	1003601	4014486485219
5		544049.1	2	1001561	4014486484618
6		603337.0	1	1000662	4014486470260
7		644362.0	1	1001077	4014486498219
8		538714.0	1	1003403	4014486463194
9		644141.1	1	1000476	4014486467475
10		609762.0	1	1001713	4014486486919
11		506671.2	1	1000506	4014486467840
12		644447.0	1	1000420	4014486466836
13		544216.0	1	1003967	4014486465938
13		544216.1	1	1003967	4014486465938
14		629402.0	1	1000409	4014486466720
15		633030.2	1	1000220	4014486462838
40		544172.0	1	1001745	4014486487299
41		061700.1	1	1003356	4014486486131
42		661427.0	1	1001228	4014486497847
43		661220.0	1	1003340	4014486488807
43		661220.1	1	1003340	4014486488807
45		077276.0	1	1000177	4014486462067
46		799181.0	1	1003970	4014486481808
47		549752.0	2	1002745	4014486460957

## TUCANO 450/440

1		549055.0	2	1003968	4014486520309
2		661031.1	1	1001564	4014486484663
3		549099.0	1	1003966	4014486491708
4		667251.1	1	1003601	4014486485219
5		544049.1	2	1001561	4014486484618
6		603337.0	1	1000662	4014486470260
7		644362.0	1	1001077	4014486498219
8		538714.0	1	1003403	4014486463194
9		644141.1	1	1000476	4014486467475
10		609762.0	1	1001713	4014486486919
11		506671.2	1	1000506	4014486467840
12		2227662.0	1	1000421	4014486466843
13		544216.0	1	1003967	4014486465938
13		544216.1	1	1003967	4014486465938
14		629402.0	1	1000409	4014486466720
15		633030.2	1	1000220	4014486462838
40		544172.0	1	1001745	4014486487299
41		061700.1	1	1003356	4014486486131
42		661427.0	1	1001228	4014486497847
43		661220.0	1	1003340	4014486488807
43		661220.1	1	1003340	4014486488807
45		077276.0	1	1000177	4014486462067
46		799181.0	1	1003970	4014486481808
47		549752.0	2	1002745	4014486460957

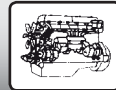

## DEUTZ-FAHR

11	ENGINE - GRAIN TANK CLUTCH	01141613	1	1001749	4014486487329
		1139214	1	1002452	4014486493337
		1139215	1	1002453	4014486493351
		1139219	1	1002468	4014486493542
		1139222	1	1002483	4014486493801
		1141502	1	1001748	4014486487312
		1141624	1	1001710	4014486486889
		1141625	1	1001727	4014486487107
		1141637	1	1001440	4014486459487
		1141762	1	1001092	4014486496741
		1141888	1	1004549	4014486721393
		1142840	1	1001383	4014486474992
		1145064	1	1001069	4014486496536
		1145334	1	1001156	4014486497373
		1145457	1	1001810	4014486488227
		1145458	1	1003651	4014486489446
		1145459	1	1001981	4014486491005
		1145590	1	1001008	4014486487909
		1145626	1	1001459	4014486459678
		1145628	1	1001311	4014486492729
		1145632	1	1001750	4014486519518
		1145660	1	1001994	4014486491173
		1145668	2	1002509	4014486494150
		1145680	1	1001298	4014486492507
		1145689	1	1002017	4014486491500
		1145690	1	1001925	4014486489934
		1145693	1	1004736	4014486719079
		1145726	1	1001464	4014486459746
		1145750	1	1001752	4014486487350
		1145751	1	1001927	4014486489965
		1145802	1	1001466	4014486459760
		1146033	1	1001744	4014486487282
		1146076	1	No AP	
		1148874	1	1003183	4014486481662
		1154311	2	1002590	4014486495850
		1154352	1	1002529	4014486494488
		1154357	1	1002547	4014486494778
		1168314	1	1002532	4014486494525
		1168325	1	1002556	4014486494983
		1174974	1	1001903	4014486489637
		1176330	1	1002562	4014486495157
		1178461	1	1004705	4014486719826
		1178685	1	1004724	4014486716504
		1178737	2	1004710	4014486716573
		1179088	2	1004709	4014486716566
		1179479	1	1002532	4014486494525
		1179564	1	1002465	4014486493504
		1179565	1	1002460	4014486493436
		1179777	1	1002452	4014486493337
		1179988	1	1002455	4014486493375
		1180150	1	1002547	4014486494778
		1180172	1	1002539	4014486494648
		1180468	1	1002529	4014486494488
		1180516	1	1003723	4014486494976
		1180517	1	1003742	4014486495690

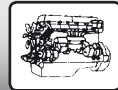

## DEUTZ-FAHR

	1180553	1	1002738	4014486496208
	1180619	1	1002537	4014486494600
	1180833	1	1004876	4014486719840
	1180847	1	1004851	4014486716542
	1180848	1	1002522	4014486494402
	1181185	1	1003713	4014486494716
	1181366	1	1002466	4014486493528
	1182063	1	1002537	4014486494600
	1182339	1	1002500	4014486494068
	1182429	1	1002500	4014486494068
	1182499	2	1002937	4014486493238
	1182599	1	1003813	4014486481501
	1183205	1	1002531	4014486494501
	2231579	1	1002460	4014486493436
	2235176	2	1002931	4014486493818
	2235255	1	1002490	4014486493931
	2235421	1	1002498	4014486494044
	2419104	2	1002985	4014486494365
	3170529	1	1000707	4014486470949
	3170537	1	1004844	4014486715842
	3651575	1	1001806	4014486488173
	4305745	1	1002525	4014486494433
	4325871	1	1003700	4014486494198
	4343181	1	1003724	4014486494969
	4435634	1	1002432	4014486493108
	4437559	1	1003743	4014486495768
	4437560	1	1002592	4014486495898
	4438414	1	1002592	4014486495898
	4450657	1	1002951	4014486495676
	4452089	1	1003781	4014486480245
	4452440	1	1002736	4014486496185
	4452801	1	1003704	4014486494396
	4455177	1	1003713	4014486494716
	4455253	1	1003105	4014486480320
	6204307	1	1001176	4014486497489
	6204311	1	1001937	4014486490343
	6204313	1	1001200	4014486497564
	6212834	4	1003059	4014486474480
	6212847	1	1002465	4014486493504
	6212850	1	1002475	4014486493627
	6212851	1	1002478	4014486493696
	6212852	1	1002483	4014486493801
	6215206	1	1001106	4014486496888
	6215207	1	1001002	4014486497250
	6215208	1	1001441	4014486459494
	6215211	1	1001197	4014486497533
	6215212	1	1001201	4014486497571
	6215226	1	1001210	4014486497694
	6215261	1	1001964	4014486490749
	6225210	1	No AP	
	6241305	2	1002917	4014486460070
	6259006	2	1001155	4014486473896
	6273876	1	1001440	4014486459487
	16006626	1	No AP	
	16015922	1	1001613	4014486485431

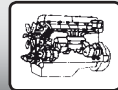

## DEUTZ-FAHR

	16015923	1	1003664	4014486490831
	16024474	1	1004579	4014486717716
	16026321	1	1001290	4014486492798
	16029939	5	1002607	4014486496147
	16031403	1	1001297	4014486492491
	16031404	2	1001138	4014486490176
	16031538	1	1001603	4014486485257
	16039033	1	1004544	4014486719642
	16042133	1	1001239	4014486491937
	16055471	1	1004655	4014486720594
	16061769	1	1004840	4014486715446
	16062265	1	1004585	4014486717778
	16062735	1	1004641	4014486718614
	16062737	1	1004541	4014486718430
	16062738	1	1003981	4014486519594
	16062763	1	1002540	4014486494686
	16062841	1	1004379	4014486714494
	16062842	1	1000302	4014486465037
	16062883	1	No AP	
	16062884	1	1002541	4014486494693
	16062885	1	1004540	4014486718423
	16063211	1	No AP	
	16064323	1	No AP	
	16617104	1	1002405	4014486479492
	33700746	1	1003547	4014486471540
	36200413	1	1000700	4014486470833
	0.017.4868.0	1	1000230	4014486463187
	0.017.7465.0	1	1004854	4014486719659
	0.017.9350.0	1	1002055	4014486475326
	0.018.1907.0	1	1004857	4014486717655
	0.018.1930.0	1	1004593	4014486717860
	0.018.3550.0	1	1004831	4014486714128
	0.018.9044.0	1	1001724	4014486487077
	0.018.9690.0	1	1003980	4014486518511
	0.0183111.0	1	1000039	4014486460766
	01100903	3	1002851	4014486465112
	01104054	1	1000887	4014486473285
	01116060	1	1000094	4014486460926
	01116062	1	1003367	4014486460971
	01116063	1	1000100	4014486461008
	01116080	1	1000196	4014486462333
	01116089	1	1000217	4014486462760
	01116091	1	1003400	4014486462906
	01116092	1	1003402	4014486463170
	01116093	1	1003414	4014486463583
	01116094	1	1003425	4014486464030
	01116095	1	1000288	4014486464726
	01116096	1	1003438	4014486464894
	01116097	1	1000336	4014486465792
	01116113	1	1000492	4014486467642
	01116114	1	1000494	4014486467666
	01116131	1	1000605	4014486469387
	01129779	1	1000228	4014486463088
	01129780	2	1002817	4014486465532
	01129970	1	1002247	4014486478143

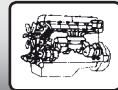

## DEUTZ-FAHR

	01130742	1	1003431	4014486464313
	01136717	1	1003422	4014486463811
	01136724	1	1000514	4014486467932
	01136729	1	1003566	4014486473735
	01136731	1	1000952	4014486474077
	01136734	1	1002050	4014486475265
	01136747	1	1002240	4014486478051
	01137509	1	1003407	4014486463354
	01139068	1	1003460	4014486466072
	01139070	1	1003478	4014486467796
	01139071	1	1000505	4014486467833
	01139073	1	1000521	4014486468014
	01139074	1	1000522	4014486468021
	01139076	1	1000525	4014486468052
	01139078	1	1000530	4014486468106
	01139079	1	1000602	4014486469349
	01139080	1	1000623	4014486469684
	01139081	1	1003519	4014486469745
	01139082	1	1003544	4014486470963
	01139083	1	1000738	4014486471335
	01139084	1	1003547	4014486471540
	01139085	1	1000784	4014486472004
	01139086	1	1000795	4014486472141
	01139088	1	1000864	4014486473025
	01139089	1	1000902	4014486473483
	01139090	1	1000926	4014486473766
	01139091	1	1003568	4014486473940
	01139092	1	1000943	4014486473971
	01139093	1	1000948	4014486474039
	01139204	1	1002257	4014486478242
	01139205	1	1002275	4014486478433
	01139206	1	1002278	4014486478464
	01139207	1	1002111	4014486476101
	01139209	1	1002232	4014486477948
	01139210	1	1003312	4014486477993
	01139213	1	1002260	4014486478273
	01139224	1	1004752	4014486719109
	01139227	1	1002045	4014486475210
	01139228	1	1004884	4014486719130
	01139230	1	1004885	4014486719154
	01139231	1	1002051	4014486475289
	01139232	1	1002055	4014486475326
	01139234	1	1002065	4014486475456
	01139235	1	1002080	4014486475708
	01139237	1	1002081	4014486475715
	01139240	1	1002152	4014486476705
	01139241	1	1002193	4014486477412
	01139242	1	1002200	4014486477504
	01139243	1	1000438	4014486467055
	01139244	1	1000439	4014486467062
	01139245	1	1000442	4014486467093
	01139246	1	1000443	4014486467109
	01139247	1	1000445	4014486467123
	01139248	1	1000448	4014486467154
	01139250	1	1000465	4014486467352





## DEUTZ-FAHR

	01139251	1	1000469	4014486467406
	01139252	1	1000545	4014486468298
	01139253	1	1002210	4014486477610
	01139254	1	1002215	4014486477665
	01139256	1	1002230	4014486477924
	01139258	1	1002245	4014486478112
	01139259	1	1002246	4014486478129
	01139260	1	1002251	4014486478181
	01139300	1	1002061	4014486475418
	01139301	1	1000779	4014486471915
	01139634	1	1002106	4014486476033
	01141373	1	1000675	4014486470475
	01141503	1	1001698	4014486486742
	01141530	1	1000435	4014486467024
	01141554	1	1000535	4014486468151
	01141555	1	1004755	4014486719185
	01141556	1	1002117	4014486476170
	01141595	2	1002907	4014486471304
	01141608	1	1001637	4014486485868
	01141622	1	1000665	4014486470314
	01141623	1	1002239	4014486478044
	01141626	2	1002908	4014486470796
	01141642	1	1002108	4014486476057
	01141643	1	1000735	4014486471311
	01141644	1	1000812	4014486472363
	01141666	1	1000794	4014486472134
	01141758	1	1000694	4014486470734
	01141765	1	1000366	4014486466287
	01141770	1	1000639	4014486469974
	01141788	2	1002841	4014486464078
	01141789	1	1003462	4014486466966
	01141792	1	1001807	4014486488180
	01141792	1	1001807	4014486488180
	01141798	1	1000792	4014486472110
	01141801	1	1002101	4014486475975
	01141816	1	1001630	4014486485738
	01141818	1	1002100	4014486475951
	01141819	1	1001644	4014486485967
	01141823	1	1000772	4014486471809
	01141840	1	1000356	4014486466133
	01141850	1	1000398	4014486466614
	01141882	1	1000654	4014486470178
	01141894	1	1000706	4014486470925
	01141917	1	1000659	4014486470239
	01141918	1	1001650	4014486486025
	01141938	1	1003513	4014486469547
	01141958	1	1000682	4014486470581
	01142150	1	1003536	4014486470598
	01143410	2	1002835	4014486463668
	01143412	2	1002909	4014486471779
	01143497	1	1000398	4014486466614
	01145003	1	1003458	4014486465990
	01145026	1	1001541	4014486460605
	01145047	1	1003411	4014486463491
	01145051	2	1000333	4014486465723



## DEUTZ-FAHR

	01145052	1	1000350	4014486466065
	01145053	1	1000434	4014486467017
	01145054	1	1000427	4014486466904
	01145055	1	1000825	4014486472516
	01145143	1	1000665	4014486470314
	01145186	1	1000764	4014486471670
	01145203	1	1000658	4014486470222
	01145211	2	1000768	4014486471755
	01145214	1	1000308	4014486465167
	01145215	1	1000324	4014486465488
	01145216	1	1000354	4014486466119
	01145218	1	1000408	4014486466713
	01145226	1	1001657	4014486486117
	01145260	1	1001612	4014486485400
	01145262	1	1001595	4014486675481
	01145263	1	1000407	4014486466706
	01145318	1	1002046	4014486475227
	01145330	1	1001636	4014486485844
	01145335	1	1000847	4014486472769
	01145348	1	1004854	4014486719659
	01145367	2	1000091	4014486460896
	01145368	1	1004565	4014486718478
	01145374	1	1001541	4014486460605
	01145449	1	1003522	4014486469905
	01145461	1	1000685	4014486470635
	01145462	1	1003532	4014486470413
	01145465	1	1001164	4014486497458
	01145475	2	1000689	4014486470673
	01145481	1	1000780	4014486471892
	01145484	1	No AP	
	01145504	1	1000683	4014486470604
	01145505	1	1000671	4014486470390
	01145625	1	1003424	4014486463996
	01145627	1	1004658	4014486718720
	01145630	1	1004139	4014486523195
	01145631	3	1002853	4014486464863
	01145633	1	1000799	4014486472189
	01145640	1	1001734	4014486487183
	01145667	1	1001622	4014486485554
	01145685	4	1000293	4014486464849
	01145697	1	1000393	4014486466560
	01145699	1	1000564	4014486468694
	01145703	1	1004545	4014486719666
	01145725	3	1002854	4014486464672
	01145738	1	1000629	4014486469790
	01145766	1	No AP	
	01145782	4	1000273	4014486464436
	01145790	2	1002839	4014486463514
	01145792	1	1000770	4014486471762
	01145823	1	1002090	4014486475838
	01145877	1	1004543	4014486719635
	01145884	1	1000685	4014486470635
	01145921	1	1000042	4014486460797
	01145922	1	1003558	4014486472899
	01145937	2	1002914	4014486484878



## DEUTZ-FAHR

	01145940	3	1002844	4014486464122
	01145949	1	1000776	4014486471854
	01145959	2	1002849	4014486463910
	01145960	3	1002755	4014486463323
	01145961	1	1001821	4014486488395
	01145970	1	1000043	4014486460803
	01145973	4	1002761	4014486465044
	01145977	1	1000268	4014486464283
	01145980	2	1004507	4014486717136
	01145989	2	1002855	4014486465679
	01145990	1	1000560	4014486468595
	01145991	1	1004093	4014486475791
	01146013	1	1000301	4014486465006
	01146027	1	1004436	4014486715354
	01146032	1	1001742	4014486487268
	01146045	1	1004419	4014486714869
	01160990	1	1000019	4014486483376
	01162717	1	1000052	4014486483727
	01163087	2	1000029	4014486483512
	01168304	1	1000018	4014486483352
	01169885	1	1000011	4014486483284
	01169889	1	1004338	4014486714241
	01179132	1	1000545	4014486468298
	01180447	1	1001041	4014486498110
	01180448	1	1001042	4014486498127
	01180450	1	1001045	4014486498158
	01180913	1	No AP	
	01181260	1	1001044	4014486498141
	01181730	1	1000981	4014486483611
	01181748	1	1004312	4014486715910
	01181768	1	1004313	4014486715927
	01182044	1	No AP	
	01182600	1	1004312	4014486715910
	01182726	1	1004688	4014486715934
	01182727	1	1004688	4014486715934
	01182767	1	1004318	4014486715972
	01183152	1	1004688	4014486715934
	01183156	1	1004316	4014486715958
	01231688	1	1000813	4014486472370
	01231696	1	1000819	4014486472455
	01231697	1	1000838	4014486472653
	01339252	1	1003485	4014486468274
	01397518	4	1002102	4014486475982
	01397596	2	1000581	4014486468984
	01397776	3	1002831	4014486463132
	01397850	4	1002809	4014486462944
	01445465	1	No AP	
	02929933	1	No AP	
	02931480	1	No AP	
	03210969	1	1003483	4014486468212
	04437549	1	1001050	4014486498202
	04437867	1	No AP	
	04439434	1	No AP	
	04453084	1	1000981	4014486483611
	06204283	1	1000044	4014486483635



## DEUTZ-FAHR

	06204284	4	1002057	4014486475357
	06204285	4	1002069	4014486475517
	06204286	4	1002999	4014486475562
	06204287	4	1003000	4014486475487
	06204288	5	1002075	4014486475647
	06204289	1	1000509	4014486467871
	06204291	1	1000652	4014486470154
	06204295	1	1000529	4014486468090
	06204296	1	1000978	4014486474381
	06204297	1	1000979	4014486474398
	06204300	5	1000444	4014486467116
	06204304	1	1000880	4014486473209
	06204305	3	1000440	4014486467079
	06204310	1	1003477	4014486467604
	06204314	1	1002163	4014486476866
	06204315	1	1000464	4014486467345
	06204317	1	1000462	4014486467321
	06204318	1	1000475	4014486467468
	06204322	1	1000906	4014486473537
	06204324	2	1002177	4014486477177
	06204325	1	1000455	4014486467246
	06204326	1	1000471	4014486467420
	06204327	1	1000474	4014486467451
	06204329	1	1000479	4014486467505
	06204331	1	1002127	4014486476309
	06204332	1	1000961	4014486474190
	06204333	1	1000958	4014486474152
	06204334	1	1003605	4014486485561
	06204335	1	1000957	4014486474145
	06210851	2	1003535	4014486470567
	06210853	2	1000406	4014486466690
	06210869	1	1003377	4014486461435
	06210870	1	1000136	4014486461534
	06210874	1	1000190	4014486462203
	06210880	1	1000199	4014486462364
	06210881	1	1000201	4014486462395
	06210889	1	1003408	4014486463392
	06210890	1	1003410	4014486463477
	06210894	1	1003427	4014486464160
	06210904	2	1003759	4014486465259
	06210906	1	1003446	4014486465365
	06210912	1	1000330	4014486465662
	06210913	1	1000331	4014486465693
	06210915	1	1000339	4014486520217
	06210916	1	1003455	4014486465907
	06210917	1	1000343	4014486465921
	06210918	1	1000344	4014486465952
	06210919	1	1000348	4014486466027
	06210921	1	1000356	4014486466133
	06210923	1	1000364	4014486466232
	06210924	1	1003461	4014486466324
	06210925	1	1000375	4014486466379
	06210927	1	1000390	4014486466539
	06210929	1	1000418	4014486466812
	06210930	1	1000428	4014486466928

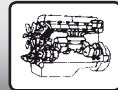

## DEUTZ-FAHR

	06210932	1	1000493	4014486467659
	06210934	1	1000496	4014486467703
	06210938	1	1000497	4014486467727
	06210939	1	1000498	4014486467734
	06210941	1	1000499	4014486467741
	06210943	1	1000502	4014486467772
	06210947	1	1003479	4014486467819
	06210951	1	1000510	4014486467888
	06210953	1	1003480	4014486467918
	06210954	1	1000516	4014486467956
	06210955	1	1000517	4014486467970
	06210957	1	1000518	4014486467987
	06210960	1	1000523	4014486468038
	06210963	1	1000526	4014486468069
	06210969	1	1003483	4014486468212
	06210970	1	1003488	4014486468366
	06210971	1	1003491	4014486468458
	06210973	1	1003500	4014486469042
	06210973	1	1003500	4014486469042
	06210975	1	1000599	4014486469318
	06210977	1	1003504	4014486469127
	06210978	1	1003508	4014486469240
	06210981	1	1003511	4014486469417
	06210984	1	1003516	4014486469677
	06210986	1	1000632	4014486469851
	06210988	1	1000646	4014486470062
	06210989	1	1003526	4014486470086
	06210990	1	1000654	4014486470178
	06210991	1	1000660	4014486470246
	06210992	1	1000670	4014486470383
	06210993	1	1003531	4014486470406
	06210994	1	1003533	4014486470451
	06210996	1	1000684	4014486470628
	06210997	1	1003541	4014486470864
	06210999	1	1000724	4014486471168
	06211001	1	1000751	4014486471496
	06211003	1	1000763	4014486471649
	06211004	1	1000769	4014486471748
	06211006	1	1003550	4014486471908
	06211009	1	1000814	4014486472387
	06211010	1	1000826	4014486472523
	06211014	1	1000879	4014486473193
	06211016	1	1000884	4014486473247
	06211019	1	1000889	4014486520286
	06211020	1	1000890	4014486473322
	06211023	1	1000892	4014486473346
	06211024	1	1000896	4014486473384
	06211025	1	1000897	4014486473407
	06211026	1	1003561	4014486473421
	06211026	1	1003561	4014486473421
	06211027	1	1000901	4014486473476
	06211031	1	1000907	4014486473544
	06211032	1	1000914	4014486473636
	06211033	1	1000920	4014486473698
	06211034	1	1000923	4014486473728

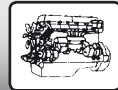

## DEUTZ-FAHR

	06211041	1	1003569	4014486473988
	06211042	1	1000945	4014486474008
	06211043	1	1000947	4014486474022
	06211046	1	1000951	4014486474060
	06211053	1	1000893	4014486473353
	06212828	2	1004754	4014486719123
	06212833	4	1002994	4014486476002
	06212839	1	1002258	4014486478259
	06212840	1	1002259	4014486478266
	06212842	1	1002261	4014486478280
	06212843	1	1002262	4014486478297
	06212845	1	1002264	4014486478310
	06212855	1	1002279	4014486478471
	06212866	1	1002049	4014486475258
	06212870	1	1004886	4014486719161
	06212871	1	1002055	4014486475326
	06212872	1	1002055	4014486475326
	06212874	1	1002059	4014486475371
	06212883	1	1002077	4014486475678
	06212885	1	1002078	4014486475685
	06212890	1	1002083	4014486475739
	06212894	1	1002093	4014486475869
	06212895	1	1002105	4014486476026
	06212896	1	1002109	4014486476064
	06212900	1	1003420	4014486463729
	06212907	1	1002199	4014486477498
	06212909	1	1000437	4014486467048
	06212915	1	1000447	4014486467147
	06212918	1	1000461	4014486467314
	06212919	1	1000463	4014486467338
	06212924	1	1002211	4014486477627
	06212925	1	1003686	4014486477757
	06212927	1	1003314	4014486477832
	06212932	1	1002234	4014486477962
	06212933	1	1002235	4014486477986
	06214290	1	1000531	4014486468113
	06215191	1	1001035	4014486496345
	06215192	1	1001036	4014486496352
	06215193	1	1001037	4014486496369
	06215194	1	No AP	
	06215218	1	No AP	
	06215219	1	1000977	4014486474374
	06215225	1	No AP	
	06215228	1	1004494	4014486718232
	06215231	1	1001638	4014486485882
	06215234	1	1001696	4014486486728
	06215235	1	1001699	4014486486759
	06215236	1	1001679	4014486486483
	06215238	1	1001628	4014486485684
	06215239	1	1001601	4014486485233
	06215240	1	1001578	4014486484823
	06215241	1	1001691	4014486486650
	06215242	1	1001686	4014486486599
	06215243	1	1003616	4014486486667
	06215248	1	1001901	4014486489613

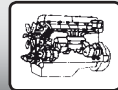

## DEUTZ-FAHR

	06215249	1	1004576	4014486717686
	06215251	1	1004580	4014486717723
	06215254	1	1001810	4014486488227
	06228207	4	1002098	4014486475913
	06235567	2	1003041	4014486477894
	06240407	1	1004845	4014486721386
	06241147	2	1000468	4014486467390
	06241910	2	1002229	4014486477917
	06242124	2	1002857	4014486467369
	06254069	3	1000453	4014486467222
	06254070	7	1000441	4014486467086
	06255583	2	1002910	4014486472288
	06256381	1	1000306	4014486497960
	06256546	3	1002759	4014486465013
	06256547	1	1000313	4014486465273
	06256619	2	1002762	4014486465570
	06256714	3	1002763	4014486464290
	06257897	2	1000854	4014486472868
	06257898	2	1002911	4014486470666
	06273236	1	1000736	4014486471298
	06273237	1	1000811	4014486472356
	06298998	1	1002067	4014486475470
	06301463	1	1003316	4014486477900
	06528420	1	No AP	
	06580049	4	1002998	4014486475906
	06580119	3	1002094	4014486475876
	11 0464	1	No AP	
	11116150117.00	1	1004845	4014486721386
	114291.3	4	1003867	4014486519952
	16062737/10	1	1004853	4014486718447
	16062737/20	1	1004542	4014486718454
	16062737/30	1	1004853	4014486718447
	1-99-51021	1	1004496	4014486716993
	1-99-51995	1	1004183	4014486554380
	1-99-71575	1	1004596	4014486717891
	2.4119.203.0	1	1004811	4014486720525
	2.4119.204.0	1	1004832	4014486714142
	2.4119.205.0	1	1004812	4014486720532
	2.4119.207.0	1	1004883	4014486714630
	2.4119.208.0	1	1004396	4014486714623
	2.4119.210.0	1	1004385	4014486713916
	2.4119.211.0	1	1004368	4014486714111
	2.4119.213.0	1	1001724	4014486487077
	317-0537	1	1004844	4014486715842
	4454180	1	1002632	4014486480252
	9351.0176.00	1	1004018	4014486519419
	T040H02	1	1004017	4014486519501
	X221765	1	1004813	4014486720549



## DEUTZ-FAHR

### M 1000

5	RETURN ELEVATOR DRIVE	6240268	1	1001372	4014486474862
13	REEL DRIVE COUNTERSHAFT	6215196	1	1001064	4014486496482
15	COUNTERSHAFT - FAN DRIVE	6215199	1	1001071	4014486496550
16	ALTERNATOR DRIVE	1139218	1	1002465	4014486493504
17	RADIATOR FAN DRIVE	1139221	1	1002478	4014486493696
19	THRESHING DRUM VARIATOR DRIVE	6215222	1	1001223	4014486497786
	REEL DRIVE VARIABLE SPEED	6215217	1	1001157	4014486497366

### M 1002

1	ENGINE - COUNTERSHAFT / M1002	6215237	1	1003655	4014486489651
2	COUNTERSHAFT - FAN DRIVE	6215197	1	1001066	4014486496505
3	THRESHING DRUM VARIATOR DRIVE	6215220	1	1001222	4014486497779
4	REEL DRIVE VARIABLE SPEED	6215217	1	1001157	4014486497366
7	COUNTERSHAFT - TRAVEL SPEED VARIATOR /-4232 M900-1002	6215213	1	1001519	4014486460384
11	COUNTERSHAFT - STRAW STRIPPER DRUM	6215250	1	1001833	4014486488562
	ALTERNATOR DRIVE (ENGINE) / -1980 M1002	2235179	1	1002460	4014486493436
	ALTERNATOR DRIVE (ENGINE) /+1981 M1002/1080	2235180	1	1002462	4014486493467
	BLOWER DRIVE (ENGINE) / M1002	2235533	1	1002482	4014486493788

### M 1102

5	COUNTERSHAFT - RETURN ELEVATOR	6240268	1	1001372	4014486474862
11	FAN DRIVE VARIABLE SPEED	6215199	1	1001071	4014486496550
12	THRESHING DRUM VARIATOR DRIVE	6215222	1	1001223	4014486497786
13	BLOWER DRIVE	2235254	1	1002483	4014486493801
14	ALTERNATOR DRIVE	2235180	1	1002462	4014486493467
	REEL DRIVE VARIABLE SPEED	6215217	1	1001157	4014486497366

### M 1200

5	RETURN ELEVATOR DRIVE	6240268	1	1001372	4014486474862
13	REEL DRIVE COUNTERSHAFT	6215196	1	1001064	4014486496482
15	COUNTERSHAFT - FAN DRIVE	6215199	1	1001071	4014486496550
16	ALTERNATOR DRIVE	1139218	1	1002465	4014486493504
17	RADIATOR FAN DRIVE	1139221	1	1002478	4014486493696
19	THRESHING DRUM VARIATOR DRIVE	6215222	1	1001223	4014486497786
	REEL DRIVE VARIABLE SPEED	6215217	1	1001157	4014486497366

### M 1202

5	COUNTERSHAFT - RETURN ELEVATOR	6240268	1	1001372	4014486474862
11	FAN DRIVE VARIABLE SPEED	6215199	1	1001071	4014486496550
12	THRESHING DRUM VARIATOR DRIVE	6215222	1	1001223	4014486497786
13	BLOWER DRIVE	2235254	1	1002483	4014486493801
14	ALTERNATOR DRIVE	2235180	1	1002462	4014486493467
	REEL DRIVE VARIABLE SPEED	6215217	1	1001157	4014486497366

### M 1300

3	THRESHING DRUM VARIATOR DRIVE	6215221	1	1001227	4014486497823
3	THRESHING DRUM VARIATOR DRIVE	6215222	1	1001223	4014486497786
15	TRACTION VARIATOR DRIVE	6215222	1	1001223	4014486497786
	REEL DRIVE VARIABLE SPEED	6215217	1	1001157	4014486497366



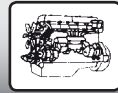
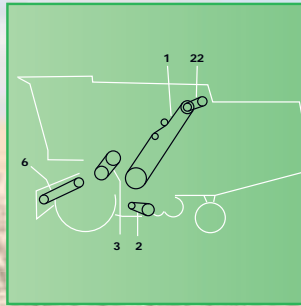
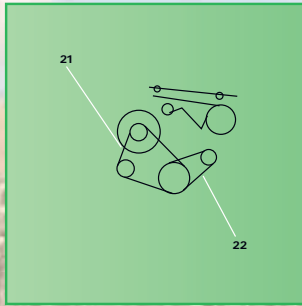
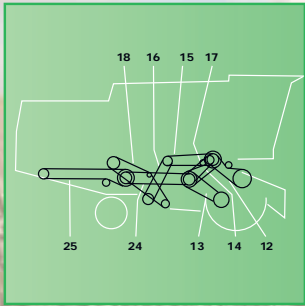

# DEUTZ-FAHR

M 1302					
3	THRESHING DRUM VARIATOR DRIVE	6215221	1	1001227	4014486497823
3	THRESHING DRUM VARIATOR DRIVE	6215222	1	1001223	4014486497786
15	TRACTION VARIATOR DRIVE	6215222	1	1001223	4014486497786
	REEL DRIVE VARIABLE SPEED	6215217	1	1001157	4014486497366
M 1302 H					
3	THRESHING DRUM VARIATOR DRIVE	6215221	1	1001227	4014486497823
3	THRESHING DRUM VARIATOR DRIVE	6215222	1	1001223	4014486497786
15	TRACTION VARIATOR DRIVE	6215222	1	1001223	4014486497786
	REEL DRIVE VARIABLE SPEED	6215217	1	1001157	4014486497366
M 1600					
3	THRESHING DRUM VARIATOR DRIVE	6215221	1	1001227	4014486497823
3	THRESHING DRUM VARIATOR DRIVE	6215222	1	1001223	4014486497786
7	ENGINE - ALTERNATOR	1139216	1	1002458	4014486493412
		1141613	1	1001749	4014486487329
		1141645	1	1003620	4014486486957
		2234343	2	1002485	4014486493856
M 1620					
3	THRESHING DRUM VARIATOR DRIVE	6215221	1	1001227	4014486497823
3	THRESHING DRUM VARIATOR DRIVE	6215222	1	1001223	4014486497786
7	ENGINE - ALTERNATOR	1139216	1	1002458	4014486493412
		1141613	1	1001749	4014486487329
		1141645	1	1003620	4014486486957
		2234343	2	1002485	4014486493856
M 1630					
3	THRESHING DRUM VARIATOR DRIVE	6215221	1	1001227	4014486497823
3	THRESHING DRUM VARIATOR DRIVE	6215222	1	1001223	4014486497786
7	ENGINE - ALTERNATOR	1139216	1	1002458	4014486493412
		1141613	1	1001749	4014486487329
		1141645	1	1003620	4014486486957
		2234343	2	1002485	4014486493856
M 2385					
1	MAIN DRIVE	6285949	1	1001916	4014486489828
2	COUNTERSHAFT - FAN DRIVE	6215197	1	1001066	4014486496505
3	STRAW STRIPPER DRUM - THRESHING DRUM	6215220	1	1001222	4014486497779
6	FEEDER CHANNEL - COUNTERSHAFT	6215205	1	1001100	4014486496826
12	STRAW STRIPPER DRUM - FEED CHANNEL	6215204	1	1001097	4014486496796
13	COUNTERSHAFT - TRAVEL SPEED VARIATOR	6215216	1	1001522	4014486460414
22	ALTERNATOR DRIVE	2235180	1	1002462	4014486493467
	REEL DRIVE VARIABLE SPEED	6215217	1	1001157	4014486497366

AG - BI  
CA - CL  
DE - DR  
FE - FO  
GO - GR  
IN - JO  
KP - KZ  
LA - ME  
NE - RO  
SA - ST  
VA - ZM  
PARTS  
SERVICE

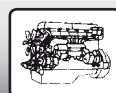
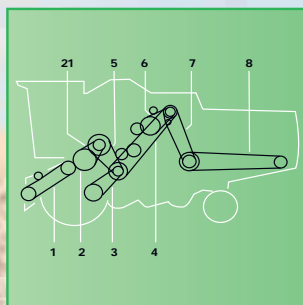
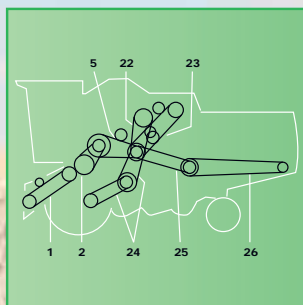
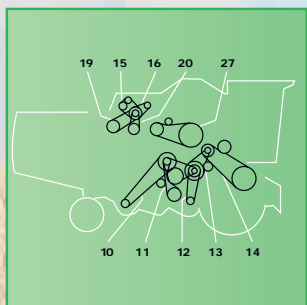

# DEUTZ-FAHR

## M 2480

1	FEEDER CHANNEL - COUNTERSHAFT	6215205	1	1001100	4014486496826
2	STRAW STRIPPER DRUM - THRESHING DRUM	6215220	1	1001222	4014486497779
3	DRIVING SPEED VARIATOR / M2580-M2685	6215214	1	1001517	4014486460360
4	ENGINE - COUNTERSHAFT / M2580.2680.2780H	6215258	1	1001912	4014486489750
5	COUNTERSHAFT - STRAW STRIPPER DRUM	6215253	1	1001843	4014486488722
7	ENGINE - CHOPPER TRANSMISSION / +102	6215245	1	1001763	4014486487466
10	COUNTERSHAFT - RETURN ELEVATOR	6210922	1	1000360	4014486466188
10	COUNTERSHAFT - RETURN ELEVATOR	06210922	1	1000360	4014486466188
11	COUNTERSHAFT - WALKER + SHAKER SHOE DRIVE	6215255	1	1003331	4014486489224
12	COUNTERSHAFT - FAN DRIVE	6215202	1	1001420	4014486459272
14	STRIPPER DRUM - FEED CHANNEL / M2480-M2680	6215203	1	1001094	4014486496765
15	BLOWER DRIVE / M2480 - M2680	2235532	2	1002925	4014486493795
16	ALTERNATOR DRIVE	2235180	1	1002462	4014486493467
19	ENGINE - COMPRESSOR	1139233	1	1002558	4014486495034
23	ENGINE - COUNTERSHAFT / M2480	6215257	1	1001882	4014486489330
24	TRAVEL SPEED VARIATOR	6215209	2	1001472	4014486459821
	REEL DRIVE VARIABLE SPEED	6215217	1	1001157	4014486497366

## M 2780

1	FEEDER CHANNEL - COUNTERSHAFT	6215205	1	1001100	4014486496826
2	STRAW STRIPPER DRUM - THRESHING DRUM	6215220	1	1001222	4014486497779
3	DRIVING SPEED VARIATOR / M2580-M2685	6215214	1	1001517	4014486460360
4	ENGINE - COUNTERSHAFT / M2580.2680.2780H	6215258	1	1001912	4014486489750
4	ENGINE - COUNTERSHAFT / M2685.2780	6215262	1	1002022	4014486491579
5	COUNTERSHAFT - STRAW STRIPPER DRUM	6215253	1	1001843	4014486488722
7	ENGINE - CHOPPER TRANSMISSION / +102	6215245	1	1001763	4014486487466
10	COUNTERSHAFT - RETURN ELEVATOR	6210922	1	1000360	4014486466188
10	COUNTERSHAFT - RETURN ELEVATOR	06210922	1	1000360	4014486466188
11	COUNTERSHAFT - WALKER + SHAKER SHOE DRIVE	6215255	1	1003331	4014486489224
12	COUNTERSHAFT - FAN DRIVE	6215202	1	1001420	4014486459272
15	BLOWER DRIVE / M2685 - 2780H.2780	2234343	2	1002485	4014486493856
16	ALTERNATOR DRIVE	2235180	1	1002462	4014486493467
19	ENGINE - COMPRESSOR	1139233	1	1002558	4014486495034
	REEL DRIVE VARIABLE SPEED	6215217	1	1001157	4014486497366

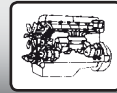
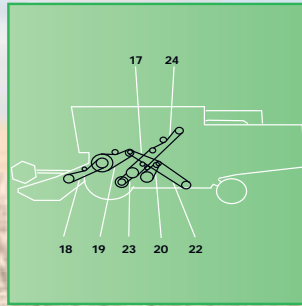
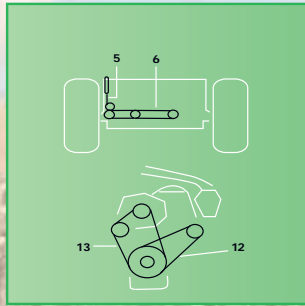
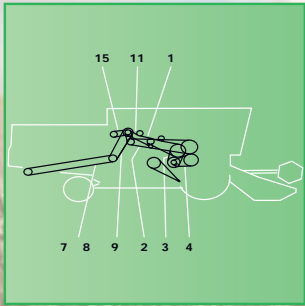

# DEUTZ-FAHR

## M 3280

1		1141591	1	1001902	4014486489620
3	THRESHING DRUM VARIATOR DRIVE	6215222	1	1001223	4014486497786
11		1141613	1	1001749	4014486487329
23		1141971	1	1001224	4014486497793
24		6215244	1	1001787	4014486487756

## M 3480

2		1141820	1	1001067	4014486496512
7		1141912	1	1003631	4014486488500
8		1141909	1	1001909	4014486489712
12		6215214	1	1001517	4014486460360
13	THRESHING DRUM VARIATOR DRIVE	6215222	1	1001223	4014486497786
14		1141944	1	1001226	4014486497816

## M 3540

2		1141820	1	1001067	4014486496512
7		1141912	1	1003631	4014486488500
8		1141909	1	1001909	4014486489712
12		6215214	1	1001517	4014486460360
13	THRESHING DRUM VARIATOR DRIVE	6215222	1	1001223	4014486497786
14		1141944	1	1001226	4014486497816

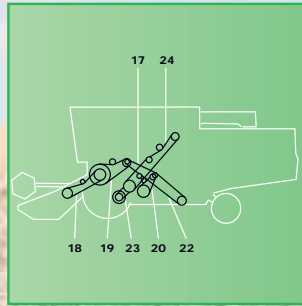
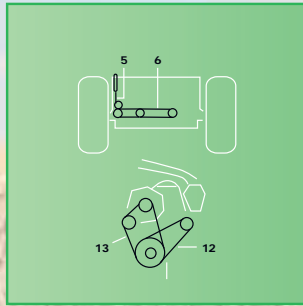
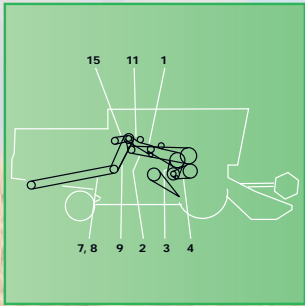

# DEUTZ-FAHR

## M 3570

1	STRAW STRIPPER DRUM	1141591	1	1001902	4014486489620
3	THRESHING DRUM VARIATOR DRIVE	6215222	1	1001223	4014486497786
8	STRAW CHOPPER - STRAW HOOD	1141645	1	1003620	4014486486957
12	ALTERNATOR DRIVE	2235180	1	1002462	4014486493467
13	BLOWER DRIVE	2234343	2	1002485	4014486493856
23	TRAVEL SPEED VARIATOR	6215223	1	1001223	4014486497786
24	ENGINE - COUNTERSHAFT	6215244	1	1001787	4014486487756
		1141971	1	1001224	4014486497793
	REEL DRIVE VARIABLE SPEED	6215217	1	1001157	4014486497366

## M 3578

1	STRAW STRIPPER DRUM	1141591	1	1001902	4014486489620
3	THRESHING DRUM VARIATOR DRIVE	6215222	1	1001223	4014486497786
8	STRAW CHOPPER - STRAW HOOD	1141645	1	1003620	4014486486957
11	ENGINE - GRAIN TANK CLUTCH / M3580	1141613	1	1001749	4014486487329
12	ALTERNATOR DRIVE	2235180	1	1002462	4014486493467
13	BLOWER DRIVE	2234343	2	1002485	4014486493856
23	TRAVEL SPEED VARIATOR	6215223	1	1001223	4014486497786
24	ENGINE - COUNTERSHAFT	6215244	1	1001787	4014486487756
	PICKING - ATTACHMENTS DRIVE (MAIZE)	1141615	1	1003624	4014486487589
		1141971	1	1001224	4014486497793
	REEL DRIVE VARIABLE SPEED	6215217	1	1001157	4014486497366

## M 3580

6		1141591	1	1001902	4014486489620
8		1141613	1	1001749	4014486487329
9	THRESHING DRUM VARIATOR DRIVE	6215222	1	1001223	4014486497786
10		1141971	1	1001224	4014486497793

## M 3610

2	REEL DRIVE VARIABLE SPEED	6215217	1	1001157	4014486497366
3		2235177	2	1002487	4014486493894
8	STRAW CHOPPER - STRAW HOOD / M3610	1141941	1	1001865	4014486489057
9		1141591	1	1001902	4014486489620
12		1141613	1	1001749	4014486487329
13	THRESHING DRUM VARIATOR DRIVE	6215222	1	1001223	4014486497786
16		1141645	1	1003620	4014486486957
17		2234343	2	1002485	4014486493856
18		2235180	1	1002462	4014486493467

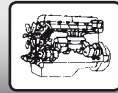
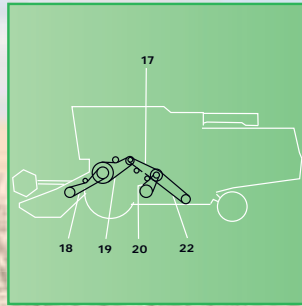
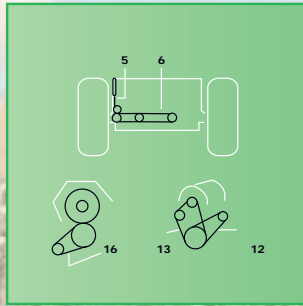
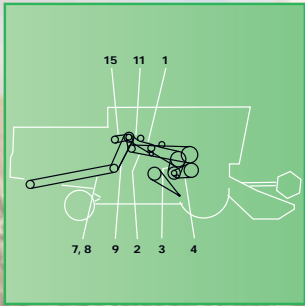

# DEUTZ-FAHR

## M 3630

3	THRESHING DRUM VARIATOR DRIVE	6215222	1	1001223	4014486497786
8	STRAW CHOPPER - STRAW HOOD / M3630/M3640	1141749	1	1001738	4014486487220
12	ALTERNATOR DRIVE / TYPE 6204	2235180	1	1002462	4014486493467
13	BLOWER DRIVE / -262 TYPE 6204	2234343	2	1002485	4014486493856
13	BLOWER DRIVE / +263 TYPE 6204	2235177	2	1002487	4014486493894
16	ALTERNATOR DRIVE / TYPE 6208	2235713	1	1002451	4014486493313
		1141510	1	1002013	4014486491432
		1141591	1	1001902	4014486489620
		1141613	1	1001749	4014486487329
	PICKING - ATTACHMENTS DRIVE (MAIZE)	1141615	1	1003624	4014486487589
		1141941	1	1001865	4014486489057

## M 3640

3	THRESHING DRUM VARIATOR DRIVE	6215222	1	1001223	4014486497786
8	STRAW CHOPPER - STRAW HOOD / M3630/M3640	1141749	1	1001738	4014486487220
12	ALTERNATOR DRIVE / TYPE 6204	2235180	1	1002462	4014486493467
13	BLOWER DRIVE / -262 TYPE 6204	2234343	2	1002485	4014486493856
13	BLOWER DRIVE / +263 TYPE 6204	2235177	2	1002487	4014486493894
16	ALTERNATOR DRIVE / TYPE 6208	2235713	1	1002451	4014486493313
		1141510	1	1002013	4014486491432
		1141591	1	1001902	4014486489620
		1141613	1	1001749	4014486487329
	PICKING - ATTACHMENTS DRIVE (MAIZE)	1141615	1	1003624	4014486487589
		1141941	1	1001865	4014486489057

## M 600

8	ELEVATOR DRIVE GRAIN	6210922	1	1000360	4014486466188
8	ELEVATOR DRIVE GRAIN	06210922	1	1000360	4014486466188
13	REEL DRIVE	6215195	1	1001062	4014486496468
15	RADIATOR FAN DRIVE	1139216	1	1002458	4014486493412
15	ALTERNATOR DRIVE	1139217	1	1002459	4014486493429

## M 660

9	STRAW WALKER - GRAIN AUGER	6210922	1	1000360	4014486466188
9	STRAW WALKER - GRAIN AUGER	06210922	1	1000360	4014486466188
16	REEL DRIVE COUNTERSHAFT	6215195	1	1001062	4014486496468
21	BLOWER DRIVE	2235175	1	1002478	4014486493696
22	ALTERNATOR DRIVE	2235178	1	1002459	4014486493429

## M 750

9	ELEVATOR SHAKER GRAIN	6210922	1	1000360	4014486466188
9	ELEVATOR SHAKER GRAIN	06210922	1	1000360	4014486466188
12	REEL DRIVE	6215195	1	1001062	4014486496468
14	ALTERNATOR DRIVE	1139216	1	1002458	4014486493412
14	RADIATOR FAN DRIVE	1139220	1	1002475	4014486493627

## M 770

9	STRAW WALKER - GRAIN AUGER	6210922	1	1000360	4014486466188
9	STRAW WALKER - GRAIN AUGER	06210922	1	1000360	4014486466188
16	REEL DRIVE COUNTERSHAFT	6215195	1	1001062	4014486496468
21	BLOWER DRIVE	2235175	1	1002478	4014486493696
22	ALTERNATOR DRIVE	2235178	1	1002459	4014486493429

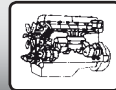

## DEUTZ-FAHR

### M 88

4		6215195	1	1001062	4014486496468
---	--	---------	---	---------	---------------

### M 88 S

4		6215195	1	1001062	4014486496468
---	--	---------	---	---------	---------------

### M 900

2	COUNTERSHAFT - FAN DRIVE	6215197	1	1001066	4014486496505
3	THRESHING DRUM VARIATOR DRIVE	6215220	1	1001222	4014486497779
4	REEL DRIVE VARIABLE SPEED	6215217	1	1001157	4014486497366
7	COUNTERSHAFT - TRAVEL SPEED VARIATOR /-4232 M900-1002	6215213	1	1001519	4014486460384
11	COUNTERSHAFT - STRAW STRIPPER DRUM	6215250	1	1001833	4014486488562
	ALTERNATOR DRIVE (ENGINE) /+2281 M900-980	2235178	1	1002459	4014486493429
	BLOWER DRIVE (ENGINE) / M900/922	2235531	1	1002475	4014486493627

### M 922

2	COUNTERSHAFT - FAN DRIVE	6215197	1	1001066	4014486496505
3	THRESHING DRUM VARIATOR DRIVE	6215220	1	1001222	4014486497779
4	REEL DRIVE VARIABLE SPEED	6215217	1	1001157	4014486497366
7	COUNTERSHAFT - TRAVEL SPEED VARIATOR /-4232 M900-1002	6215213	1	1001519	4014486460384
7	COUNTERSHAFT - TRAVEL SPEED VARIATOR /+4233 M980/1080	6215215	1	1001520	4014486460391
11	COUNTERSHAFT - STRAW STRIPPER DRUM	6215250	1	1001833	4014486488562
	BLOWER DRIVE (ENGINE) / M900/922	2235531	1	1002475	4014486493627

### MEGA 218

18	AT 4.5M - 5.1M	01139067	3	1002856	4014486465358
----	----------------	----------	---	---------	---------------

### POWERLINER 4030

1		6215217	1	1001157	4014486497366
2		2235254	1	1002483	4014486493801
9		1145261	1	1001827	4014486488487
10		6215258	1	1001912	4014486489750
12		1145224	1	1001072	4014486496567
13		1141971	1	1001224	4014486497793

### POWERLINER 4035

1		6215217	1	1001157	4014486497366
2		2235254	1	1002483	4014486493801
9		1145261	1	1001827	4014486488487
10		6215258	1	1001912	4014486489750
12		1145224	1	1001072	4014486496567
13		1141971	1	1001224	4014486497793

### STARLINER 4040

5		1141941	1	1001865	4014486489057
6		1141591	1	1001902	4014486489620
8		1141613	1	1001749	4014486487329
9		6215244	1	1001787	4014486487756
10	THRESHING DRUM VARIATOR DRIVE	6215222	1	1001223	4014486497786
13		1141645	1	1003620	4014486486957
14		1145331	1	1001075	4014486496598
15		2235180	1	1002462	4014486493467

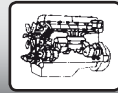
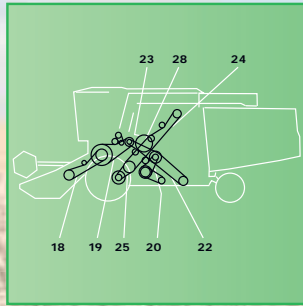
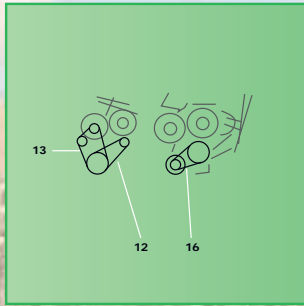
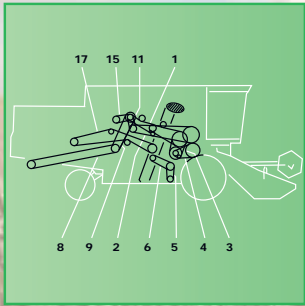

# DEUTZ-FAHR

## STARLINER 4045

5		1141941	1	1001865	4014486489057
6		1141591	1	1001902	4014486489620
8		1141613	1	1001749	4014486487329
9		6215244	1	1001787	4014486487756
10	THRESHING DRUM VARIATOR DRIVE	6215222	1	1001223	4014486497786
13		1141645	1	1003620	4014486486957
14		1145331	1	1001075	4014486496598
15		2235180	1	1002462	4014486493467

## TOPLINER 4060

1	ENGINE - STRAW STRIPPER DRUM	1145050	1	1001917	4014486489835
5	FAN DRIVE VARIABLE SPEED - CLEANING FAN	1145097	1	1001073	4014486496574
6	STRAW WALKER - VARIATOR	1145202	1	1001075	4014486496598
8	FOR STRAW CHOPPER INTEGRATED	1145187	1	1001740	4014486487244
8	FOR STRAW CHOPPER INTEGRATED	1145188	1	1001716	4014486486971
11	ENGINE - GRAIN TANK CLUTCH	1141613	1	1001749	4014486487329
12	ALTERNATOR DRIVE	2235180	1	1002462	4014486493467
13	BLOWER DRIVE	2234343	2	1002485	4014486493856
13	BLOWER DRIVE	2235177	2	1002487	4014486493894
18	PICKING - ATTACHMENTS DRIVE (MAIZE)	1145025	1	1001779	4014486520378
19	EQUIPMENT (MAIZE)	1141941	1	1001865	4014486489057
24	ENGINE - COUNTERSHAFT	1145102	1	1001788	4014486487763
25	TRAVEL SPEED VARIATOR	1141944	1	1001226	4014486497816
	SHAKER SHOE - WALKER TRANSMISSION	01143413	3	1002852	4014486464498

## TOPLINER 4065

1	ENGINE - STRAW STRIPPER DRUM	1145050	1	1001917	4014486489835
5	FAN DRIVE VARIABLE SPEED - CLEANING FAN	1145097	1	1001073	4014486496574
6	STRAW WALKER - VARIATOR	1145202	1	1001075	4014486496598
8	FOR STRAW CHOPPER INTEGRATED	1145187	1	1001740	4014486487244
8	FOR STRAW CHOPPER INTEGRATED	1145188	1	1001716	4014486486971
11	ENGINE - GRAIN TANK CLUTCH	1141613	1	1001749	4014486487329
12	ALTERNATOR DRIVE	2235180	1	1002462	4014486493467
13	BLOWER DRIVE	2234343	2	1002485	4014486493856
13	BLOWER DRIVE	2235177	2	1002487	4014486493894
18	PICKING - ATTACHMENTS DRIVE (MAIZE)	1145025	1	1001779	4014486520378
19	EQUIPMENT (MAIZE)	1141941	1	1001865	4014486489057
24	ENGINE - COUNTERSHAFT	1145102	1	1001788	4014486487763
25	TRAVEL SPEED VARIATOR	1141944	1	1001226	4014486497816
	SHAKER SHOE - WALKER TRANSMISSION	01143413	3	1002852	4014486464498

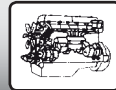
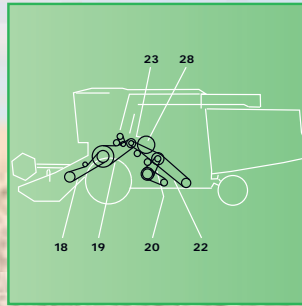
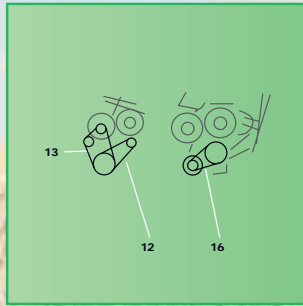
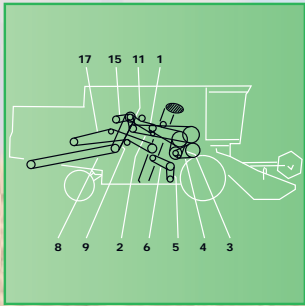

## DEUTZ-FAHR

### TOPLINER 4070

1	STRAW STRIPPER DRUM	1145056	1	1002028	4014486491630
1	STRAW STRIPPER DRUM	1145057	1	1001269	4014486492354
5	FAN DRIVE VARIABLE SPEED - CLEANING FAN	1145332	1	1001073	4014486496574
5	FAN DRIVE VARIABLE SPEED - CLEANING FAN	1145369	1	1001074	4014486496581
6	STRAW WALKER - VARIATOR	1145331	1	1001075	4014486496598
8	CHOPPER DRIVE	1145187	1	1001740	4014486487244
8	CHOPPER DRIVE	1145188	1	1001716	4014486486971
9	CHOPPER DRIVE	1145479	1	1001767	4014486487510
11	CLUTCH GRAIN TANK	1141613	1	1001749	4014486487329
12	ALTERNATOR DRIVE FOR 4070/4075	2235180	1	1002462	4014486493467
13	BLOWER DRIVE FOR 4070/4075	2235177	2	1002487	4014486493894
18	CUTTING TABLE DRIVE	1145025	1	1001779	4014486520378
19	FEEDER CHANNEL	1141941	1	1001865	4014486489057
19	FEEDER CHANNEL	1145329	1	1001863	4014486489026
	SHAKER SHOE DRIVE	01143413	3	1002852	4014486464498

### TOPLINER 4075

1	STRAW STRIPPER DRUM	1145056	1	1002028	4014486491630
1	STRAW STRIPPER DRUM	1145057	1	1001269	4014486492354
5	FAN DRIVE VARIABLE SPEED - CLEANING FAN	1145332	1	1001073	4014486496574
5	FAN DRIVE VARIABLE SPEED - CLEANING FAN	1145369	1	1001074	4014486496581
6	STRAW WALKER - VARIATOR	1145331	1	1001075	4014486496598
8	CHOPPER DRIVE	1145187	1	1001740	4014486487244
8	CHOPPER DRIVE	1145188	1	1001716	4014486486971
9	CHOPPER DRIVE	1145479	1	1001767	4014486487510
11	CLUTCH GRAIN TANK	1141613	1	1001749	4014486487329
12	ALTERNATOR DRIVE FOR 4070/4075	2235180	1	1002462	4014486493467
13	BLOWER DRIVE FOR 4070/4075	2235177	2	1002487	4014486493894
16	ALTERNATOR DRIVE FOR 4075/4080/4090	2237477	1	1002452	4014486493337
18	CUTTING TABLE DRIVE	1145025	1	1001779	4014486520378
19	FEEDER CHANNEL	1141941	1	1001865	4014486489057
19	FEEDER CHANNEL	1145329	1	1001863	4014486489026
	SHAKER SHOE DRIVE	01143413	3	1002852	4014486464498

### TOPLINER 4080

1	STRAW STRIPPER DRUM	1145056	1	1002028	4014486491630
1	STRAW STRIPPER DRUM	1145057	1	1001269	4014486492354
5	FAN DRIVE VARIABLE SPEED - CLEANING FAN	1145332	1	1001073	4014486496574
5	FAN DRIVE VARIABLE SPEED - CLEANING FAN	1145369	1	1001074	4014486496581
6	STRAW WALKER - VARIATOR	1145331	1	1001075	4014486496598
8	CHOPPER DRIVE	1145187	1	1001740	4014486487244
8	CHOPPER DRIVE	1145188	1	1001716	4014486486971
9	CHOPPER DRIVE	1145479	1	1001767	4014486487510
11	CLUTCH GRAIN TANK	1141615	1	1003624	4014486487589
16	ALTERNATOR DRIVE FOR 4075/4080/4090	2237477	1	1002452	4014486493337
18	CUTTING TABLE DRIVE	1145025	1	1001779	4014486520378
19	FEEDER CHANNEL	1141941	1	1001865	4014486489057
19	FEEDER CHANNEL	1145329	1	1001863	4014486489026
	SHAKER SHOE DRIVE	01143413	3	1002852	4014486464498



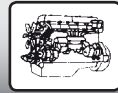
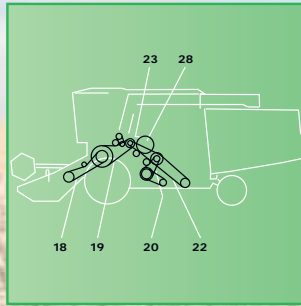
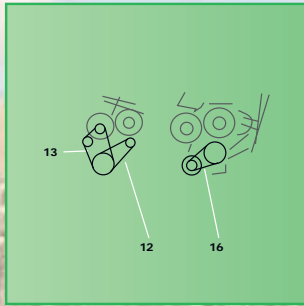
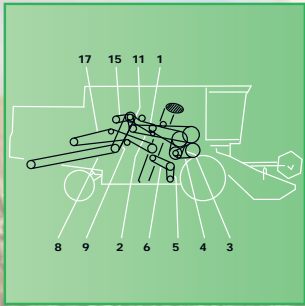

# DEUTZ-FAHR

## TOPLINER 4090

1	STRAW STRIPPER DRUM	1145056	1	1002028	4014486491630
1	STRAW STRIPPER DRUM	1145057	1	1001269	4014486492354
5	FAN DRIVE VARIABLE SPEED - CLEANING FAN	1145332	1	1001073	4014486496574
5	FAN DRIVE VARIABLE SPEED - CLEANING FAN	1145369	1	1001074	4014486496581
6	STRAW WALKER - VARIATOR	1145331	1	1001075	4014486496598
8	CHOPPER DRIVE	1145187	1	1001740	4014486487244
8	CHOPPER DRIVE	1145188	1	1001716	4014486486971
9	CHOPPER DRIVE	1145479	1	1001767	4014486487510
11	CLUTCH GRAIN TANK	1141615	1	1003624	4014486487589
16	ALTERNATOR DRIVE FOR 4075/4080/4090	2237477	1	1002452	4014486493337
18	CUTTING TABLE DRIVE	1145025	1	1001779	4014486520378
19	FEEDER CHANNEL	1141941	1	1001865	4014486489057
19	FEEDER CHANNEL	1145329	1	1001863	4014486489026
	SHAKER SHOE DRIVE	01143413	3	1002852	4014486464498

## TOPLINER 8XL

1		1145744	1	1001309	4014486492699
9		1180173	1	1002468	4014486493542
11		1145742	1	1001299	4014486492521
14		1145332	1	1001073	4014486496574
15		1145724	1	1001076	4014486496604
18		1145865	1	1001991	4014486491111
19		1145866	1	1001926	4014486489941
24		1141904	1	1001457	4014486459654



## DRONNINGBORG

### 8300

13		41990001	1	1002212	4014486477634
----	--	----------	---	---------	---------------

### DRONNINGBORG

4	HYDRAULIC PUMP DRIVE	41991400	1	1001559	4014486484588
6	STRAW CHOPPER DRIVE	41986500	1	1000805	4014486472271
7	COUNTERSHAFT DRIVE	41989100	1	1000915	4014486473643
8	FEEDER SHAFT (UPPER)	41988900	1	1000899	4014486473438

### D 1200

1	FILLING ELEVATOR	41935700	1	1003447	4014486465464
1	FILLING ELEVATOR	41935700	1	1003447	4014486465464
3	ELEVATOR - RETURN ELEVATOR GRAIN	41932600	1	1000289	4014486464757
4	COUNTERSHAFT DRIVE	41998900	1	No AP	
6	DRIVING GEAR	41996300	1	1002205	4014486477566
7	AWNER SHAFT	41974300	1	1001357	4014486474718
8	STRAW SHAKER	41966500	1	1003444	4014486465235
10	FEEDER SHAFT (UPPER)	41937300	1	1000339	4014486520217
11	KNIFE DRIVE	41964400	1	1003409	4014486463415
12	FEEDER AUGER	41953700	1	1003505	4014486469196
13	HYDRAULIC DRIVE VARIATOR	41996500	1	1002150	4014486476682
15	SPRING LOADED DRIVE VARIATOR	41994300	1	1001215	4014486497748
16	STRAW GUIDE	41926100	1	1000224	4014486462913
20	STRAW GUIDE	41996100	1	1002080	4014486475708
21	MAIN FAN VARIABLE SPEED DRIVE	41928100	1	1003415	4014486463637
22	MAIN FAN	41930300	1	1003426	4014486464092
24	FEEDER SHAFT (UPPER)	41954800	1	1003537	4014486470611

### D 1250

1	FILLING ELEVATOR	41935700	1	1003447	4014486465464
3	ELEVATOR - RETURN ELEVATOR GRAIN	41932600	1	1000289	4014486464757
4	COUNTERSHAFT DRIVE	41998900	1	No AP	
6	DRIVING GEAR	41996300	1	1002205	4014486477566
7	AWNER SHAFT	41974300	1	1001357	4014486474718
8	STRAW SHAKER	41966500	1	1003444	4014486465235
10	FEEDER SHAFT (UPPER)	41937300	1	1000339	4014486520217
11	KNIFE DRIVE	41964400	1	1003409	4014486463415
12	FEEDER AUGER	41953700	1	1003505	4014486469196
13	HYDRAULIC DRIVE VARIATOR	41996500	1	1002150	4014486476682
15	SPRING LOADED DRIVE VARIATOR	41994300	1	1001215	4014486497748
16	STRAW GUIDE	41926100	1	1000224	4014486462913
20	STRAW GUIDE	41996100	1	1002080	4014486475708
21	MAIN FAN VARIABLE SPEED DRIVE	41928100	1	1003415	4014486463637
22	MAIN FAN	41930300	1	1003426	4014486464092
24	FEEDER SHAFT (UPPER)	41954800	1	1003537	4014486470611

### D 1500

1	FAN DRIVE	41928100	1	1003415	4014486463637
2	COUNTERSHAFT DRIVE	41996400	1	1002071	4014486475579
4	FAN DRIVE	41974300	1	1001357	4014486474718
6	HYDRAULIC DRIVE VARIATOR	41996500	1	1002150	4014486476682
7	GEAR BOX	41994300	1	1001215	4014486497748
10	SHAKER SHAFT DRIVE	41966900	1	1003449	4014486465501
11	FILLING AUGER	41997600	1	1002197	4014486477467



## DRONNINGBORG

14	FEEDER AUGER	41953700	1	1003505	4014486469196
22	THRESHING DRUM VARIATOR DRIVE	41981900	1	1000570	4014486468786
29	CRANK PULLEY	41964400	1	1003409	4014486463415

### D 1600

1	FILLING ELEVATOR	41935700	1	1003447	4014486465464
3	ELEVATOR - RETURN ELEVATOR GRAIN	41932600	1	1000289	4014486464757
4	COUNTERSHAFT DRIVE	41998900	1	No AP	
6	DRIVING GEAR	41996300	1	1002205	4014486477566
7	AWNER SHAFT	41974300	1	1001357	4014486474718
8	STRAW SHAKER	41966500	1	1003444	4014486465235
10	FEEDER SHAFT (UPPER)	41937300	1	1000339	4014486520217
11	KNIFE DRIVE	41964400	1	1003409	4014486463415
12	FEEDER AUGER	41953700	1	1003505	4014486469196
13	HYDRAULIC DRIVE VARIATOR	41996500	1	1002150	4014486476682
15	SPRING LOADED DRIVE VARIATOR	41994300	1	1001215	4014486497748
16	STRAW GUIDE	41926100	1	1000224	4014486462913
20	STRAW GUIDE	41996100	1	1002080	4014486475708
21	MAIN FAN VARIABLE SPEED DRIVE	41928100	1	1003415	4014486463637
22	MAIN FAN	41930300	1	1003426	4014486464092
24	FEEDER SHAFT (UPPER)	41954800	1	1003537	4014486470611

### D 1650

1	FILLING ELEVATOR	41935700	1	1003447	4014486465464
3	ELEVATOR - RETURN ELEVATOR GRAIN	41932600	1	1000289	4014486464757
4	COUNTERSHAFT DRIVE	41998900	1	No AP	
6	DRIVING GEAR	41996300	1	1002205	4014486477566
7	AWNER SHAFT	41974300	1	1001357	4014486474718
8	STRAW SHAKER	41966500	1	1003444	4014486465235
10	FEEDER SHAFT (UPPER)	41937300	1	1000339	4014486520217
11	KNIFE DRIVE	41964400	1	1003409	4014486463415
12	FEEDER AUGER	41953700	1	1003505	4014486469196
13	HYDRAULIC DRIVE VARIATOR	41996500	1	1002150	4014486476682
15	SPRING LOADED DRIVE VARIATOR	41994300	1	1001215	4014486497748
16	STRAW GUIDE	41926100	1	1000224	4014486462913
20	STRAW GUIDE	41996100	1	1002080	4014486475708
21	MAIN FAN VARIABLE SPEED DRIVE	41928100	1	1003415	4014486463637
22	MAIN FAN	41930300	1	1003426	4014486464092
24	FEEDER SHAFT (UPPER)	41954800	1	1003537	4014486470611

### D 1800

1	FAN DRIVE	41928100	1	1003415	4014486463637
2	COUNTERSHAFT DRIVE	41996400	1	1002071	4014486475579
4	FAN DRIVE	41974300	1	1001357	4014486474718
6	HYDRAULIC DRIVE VARIATOR	41996500	1	1002150	4014486476682
7	GEAR BOX	41994300	1	1001215	4014486497748
10	SHAKER SHAFT DRIVE	41966900	1	1003449	4014486465501
11	FILLING AUGER	41997600	1	1002197	4014486477467
14	FEEDER AUGER	41953700	1	1003505	4014486469196
22	THRESHING DRUM VARIATOR DRIVE	41981900	1	1000570	4014486468786
29	CRANK PULLEY	41964400	1	1003409	4014486463415

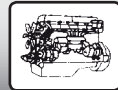

## DRONNINGBORG

### D 1900

1		41983500	1	1000611	4014486469493
2		41964300	1	1003405	4014486463309
5		41950600	1	1003524	4014486469998
6		41950900	1	1000600	4014486469325
9		41987200	1	1003518	4014486469714
10		41935200	1	1000318	4014486465372
12		41928900	1	1000249	4014486463828
13		41942100	1	1000404	4014486466676
14		41987300	1	1000815	4014486472400
18		41935900	1	1000328	4014486465587
19		41950400	1	1003517	4014486469691
20		41929200	1	1003424	4014486463996

### D 2250

1	FEEDER AUGER	41983500	1	1000611	4014486469493
2	COUNTERSHAFT DRIVE	41964300	1	1003405	4014486463309
2	KNIFE DRIVE	41964300	1	1003405	4014486463309
3	COUNTERSHAFT DRIVE	41955400	1	1000724	4014486471168
3	FEEDER SHAFT (UPPER)	41955400	1	1000724	4014486471168
5	ELEVATOR DRIVE GRAIN	41954100	1	1000645	4014486470055
5	ECCENTRIC SHAFT DRIVE	41982200	1	1003499	4014486469004
6	CENTER SHAFT	41987100	1	1000602	4014486469349
6	STRAW SHAKER - RETURN AUGER	41989900	1	1001375	4014486474893
7	INTERMEDIATE SHAFT	41950000	1	1000625	4014486469738
7	ENGINE	41994600	1	1001845	4014486488746
9	STRAW GUIDE	41950000	1	1000625	4014486469738
9	COUNTERSHAFT DRIVE	41995600	1	1001822	4014486488401
10	HYDRAULIC PUMP DRIVE	41997200	1	1003676	4014486476460
10	HYDRAULIC PUMP DRIVE	41997200	1	1003676	4014486476460
11	RETURN AUGER DRIVE	41989900	1	1001375	4014486474893
11	COUNTER DRIVE	41999700	1	1002208	4014486477597
12	STRAW CUTTER	41999800	1	1002207	4014486477580
13	STRAW CHOPPER DRIVE	41940900	1	1000385	4014486466485
13	STRAW GUIDE - DISCHARGE AUGER	41995100	2	1000546	4014486468328
14	MAIN FAN	41957600	1	1000656	4014486470208
14	THRESHING DRUM VARIATOR DRIVE	41957800	1	1000706	4014486470925
14	THRESHING DRUM VARIATOR DRIVE	D41957800	1	1000706	4014486470925
15	MAIN FAN	41950100	1	1000627	4014486469776
16	MAIN FAN VARIABLE SPEED DRIVE	41950200	1	1003539	4014486470727
17	MAIN FAN	41950300	3	1002859	4014486471007

### D 2500

1	FEEDER AUGER	41983500	1	1000611	4014486469493
2	KNIFE DRIVE	41964300	1	1003405	4014486463309
3	COUNTERSHAFT DRIVE	41955400	1	1000724	4014486471168
5	ECCENTRIC SHAFT DRIVE	41982200	1	1003499	4014486469004
6	STRAW SHAKER - RETURN AUGER	41989900	1	1001375	4014486474893
7	INTERMEDIATE SHAFT	41950000	1	1000625	4014486469738
9	COUNTERSHAFT DRIVE	41995600	1	1001822	4014486488401
10	HYDRAULIC PUMP DRIVE	41997200	1	1003676	4014486476460
11	COUNTER DRIVE STRAW CHOPPER	41999700	1	1002208	4014486477597
12	STRAW CUTTER	41999800	1	1002207	4014486477580
13	STRAW GUIDE - DISCHARGE AUGER	41995100	2	1000546	4014486468328

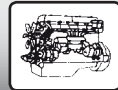

## DRONNINGBORG

14	THRESHING DRUM VARIATOR DRIVE	41957800	1	1000706	4014486470925
14	THRESHING DRUM VARIATOR DRIVE	D41957800	1	1000706	4014486470925
16	MAIN FAN VARIABLE SPEED DRIVE	41950200	1	1003539	4014486470727
17	MAIN FAN	41950300	3	1002859	4014486471007
<b>D 2600</b>					
1	FEEDER AUGER	41983500	1	1000611	4014486469493
2	KNIFE DRIVE	41964300	1	1003405	4014486463309
3	COUNTERSHAFT DRIVE	41955400	1	1000724	4014486471168
7	CENTER SHAFT	41950000	1	1000625	4014486469738
8	STRAW GUIDE	41986800	1	1000684	4014486470628
10	ENGINE	41997200	1	1003676	4014486476460
11	COUNTER DRIVE	41999700	1	1002208	4014486477597
12	STRAW CHOPPER DRIVE	41999800	1	1002207	4014486477580
14	THRESHING DRUM VARIATOR DRIVE	41957800	1	1000706	4014486470925
14	THRESHING DRUM VARIATOR DRIVE	D41957800	1	1000706	4014486470925
16	SELECTOR FOR MAIN FAN	41950200	1	1003539	4014486470727
17	MAIN FAN	41950300	3	1002859	4014486471007
<b>D 3000 S</b>					
1	RETURN AUGER (UPPER)	41964300	1	1003405	4014486463309
5	HYDRAULIC PUMP DRIVE	41924900	1	1003394	4014486462692
8	COUNTERSHAFT DRIVE	41992700	1	1000910	4014486473575
9	FEEDER SHAFT (UPPER)	41983900	1	1003521	4014486469882
10	COUNTER DRIVE	41955900	1	1000704	4014486470888
10	COUNTER DRIVE STRAW CHOPPER	41955900	1	1000704	4014486470888
11	COUNTER DRIVE	41955900	1	1000704	4014486470888
11	COUNTER DRIVE STRAW CHOPPER	41955900	1	1000704	4014486470888
14	INTERMEDIATE SHAFT	41926600	1	1000235	4014486463361
15	ELEVATOR DRIVE GRAIN	41937600	1	1003450	4014486465600
15	STRIPPER BEATER	41937600	1	1003450	4014486465600
16	DISCHARGE AUGER SHAFT	41984300	1	1000898	4014486473414
17	ECCENTRIC SHAFT DRIVE	41926300	1	1000230	4014486463187
18	MAIN FAN	41930300	1	1003426	4014486464092
19	ECCENTRIC SHAFT DRIVE	41934900	1	1003445	4014486465303
19	MAIN FAN SELECTOR	41934900	1	1003445	4014486465303
19	AWNER SHAFT	41966500	1	1003444	4014486465235
20	DISCHARGE AUGER SHAFT	41980300	1	1001439	4014486459470
20	STRIPPER BEATER	41980600	1	1001439	4014486459470
20	DISCHARGE AUGER SHAFT	D41980300	1	1001439	4014486459470
20	STRIPPER BEATER	D41980600	1	1001439	4014486459470
<b>D 4000</b>					
1	STRIPPER BEATER	41964300	1	1003405	4014486463309
2	FILLING AUGER	41972200	1	1001353	4014486474664
2	FILLING AUGER	41972300	1	1001353	4014486474664
2	FILLING AUGER	D41972300	1	1001353	4014486474664
3	STRIPPER BEATER	41992200	1	1001653	4014486486063
4	HYDRAULIC PUMP DRIVE	41924900	1	1003394	4014486462692
5	PROPULSION PUMP DRIVE	41992100	1	1001643	4014486485950
6	STRAW CHOPPER DRIVE	41958500	1	1000859	4014486472936
7	FEEDER DRUM	41953700	1	1003505	4014486469196
8	COUNTERSHAFT DRIVE	41964400	1	1003409	4014486463415
9	COUNTERSHAFT DRIVE	41992400	1	1000918	4014486473674
9	COUNTERSHAFT DRIVE	41992700	1	1000910	4014486473575

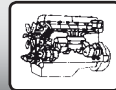

## DRONNINGBORG

10	FEEDER SHAFT (UPPER)	41983900	1	1003521	4014486469882
11	COUNTER DRIVE STRAW CHOPPER	41955900	1	1000704	4014486470888
12	STRAW WALKER - ECCENTRIC	41972800	1	1001355	4014486474695
12	STRAW WALKER - ECCENTRIC	D41972800	1	1001355	4014486474695
13	AWNER SHAFT - FAN SHAFT	41958500	1	1000859	4014486472936
13	AWNER SHAFT - FAN SHAFT	41978500	1	1001365	4014486474794
14	INTERMEDIATE SHAFT	41926600	1	1000235	4014486463361
15	ELEVATOR DRIVE GRAIN	41937600	1	1003450	4014486465600
16	DISCHARGE AUGER SHAFT	41984300	1	1000898	4014486473414
17	MAIN FAN SELECTOR	41926300	1	1000230	4014486463187
18	MAIN FAN	41930300	1	1003426	4014486464092
19	ECCENTRIC SHAFT DRIVE	41934900	1	1003445	4014486465303
19	ECCENTRIC SHAFT DRIVE	41966500	1	1003444	4014486465235
20	THRESHING DRUM VARIATOR DRIVE	41980300	1	1001439	4014486459470
20	THRESHING DRUM VARIATOR DRIVE	D41980300	1	1001439	4014486459470

### D 4000 S

1	STRIPPER BEATER	41964300	1	1003405	4014486463309
2	FILLING AUGER	41972200	1	1001353	4014486474664
2	FILLING AUGER	41972300	1	1001353	4014486474664
2	FILLING AUGER	D41972300	1	1001353	4014486474664
3	STRIPPER BEATER	41992200	1	1001653	4014486486063
4	HYDRAULIC PUMP DRIVE	41924900	1	1003394	4014486462692
5	PROPULSION PUMP DRIVE	41992100	1	1001643	4014486485950
6	STRAW CHOPPER DRIVE	41958500	1	1000859	4014486472936
7	FEEDER DRUM	41953700	1	1003505	4014486469196
8	COUNTERSHAFT DRIVE	41964400	1	1003409	4014486463415
9	COUNTERSHAFT DRIVE	41992400	1	1000918	4014486473674
9	COUNTERSHAFT DRIVE	41992700	1	1000910	4014486473575
10	FEEDER SHAFT (UPPER)	41983900	1	1003521	4014486469882
11	COUNTER DRIVE STRAW CHOPPER	41955900	1	1000704	4014486470888
12	STRAW WALKER - ECCENTRIC	41972800	1	1001355	4014486474695
12	STRAW WALKER - ECCENTRIC	D41972800	1	1001355	4014486474695
13	AWNER SHAFT - FAN SHAFT	41958500	1	1000859	4014486472936
13	AWNER SHAFT - FAN SHAFT	41978500	1	1001365	4014486474794
14	INTERMEDIATE SHAFT	41926600	1	1000235	4014486463361
15	ELEVATOR DRIVE GRAIN	41937600	1	1003450	4014486465600
16	DISCHARGE AUGER SHAFT	41984300	1	1000898	4014486473414
17	MAIN FAN SELECTOR	41926300	1	1000230	4014486463187
18	MAIN FAN	41930300	1	1003426	4014486464092
19	ECCENTRIC SHAFT DRIVE	41934900	1	1003445	4014486465303
19	ECCENTRIC SHAFT DRIVE	41966500	1	1003444	4014486465235
20	THRESHING DRUM VARIATOR DRIVE	41980300	1	1001439	4014486459470
20	THRESHING DRUM VARIATOR DRIVE	D41980300	1	1001439	4014486459470

### D 4500

1	RETURN AUGER (UPPER)	41964300	1	1003405	4014486463309
2	FILLING AUGER	41972100	1	1001352	4014486474657
3	STRIPPER BEATER	41991600	1	1003647	4014486489279
5	STRAW CHOPPER DRIVE	41958500	1	1000859	4014486472936
9	COUNTER DRIVE STRAW CHOPPER	41955900	1	1000704	4014486470888
10	STRAW SHAKER - ECCENTRIC SHAFT	41972800	1	1001355	4014486474695
10	STRAW SHAKER - ECCENTRIC SHAFT	D41972800	1	1001355	4014486474695
13	FAN SHAFT AWNER SHAFT	41978500	1	1001365	4014486474794
14	INTERMEDIATE SHAFT	41912300	1	1003380	4014486461749

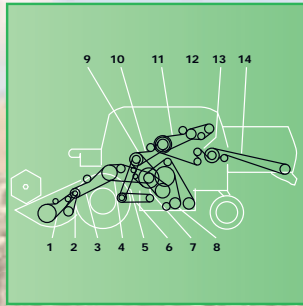
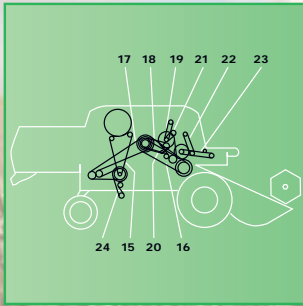

## DRONNINGBORG

16	ELEVATOR DRIVE GRAIN	41935700	1	1003447	4014486465464
17	DISCHARGE AUGER SHAFT	41988700	1	1003562	4014486473452
18	MAIN FAN SELECTOR	41926300	1	1000230	4014486463187
19	MAIN FAN	41930300	1	1003426	4014486464092
20	ECCENTRIC SHAFT DRIVE	41935500	1	1000321	4014486465419
21	THRESHING DRUM VARIATOR DRIVE	41980800	1	1001501	4014486460155

### D 500

2	STRIPPER BEATER - SHAKER	41974300	1	1001357	4014486474718
4	RETURN ELEVATOR DRIVE	41932800	1	1003437	4014486464818
4	RETURN ELEVATOR DRIVE	D41932800	1	1003437	4014486464818
6	FAN SECOND CLEANER	41974300	1	1001357	4014486474718
9	FILLING AUGER	41964500	1	1003408	4014486463392
14	HYDRAULIC PUMP DRIVE	41902600	1	1000086	4014486460834

### D 600

2	STRIPPER BEATER - SHAKER	41974300	1	1001357	4014486474718
4	RETURN ELEVATOR DRIVE	41932800	1	1003437	4014486464818
4	RETURN ELEVATOR DRIVE	D41932800	1	1003437	4014486464818
6	FAN SECOND CLEANER	41974300	1	1001357	4014486474718
9	FILLING AUGER	41964500	1	1003408	4014486463392
14	HYDRAULIC PUMP DRIVE	41902600	1	1000086	4014486460834

### D 7000

1	FEEDER DRUM	41983500	1	1000611	4014486469493
2	CRANKSHAFT	41964300	1	1003405	4014486463309
3	COUNTERSHAFT DRIVE	41993000	1	1001104	4014486496864
5		41950600	1	1003524	4014486469998
6		41950900	1	1000600	4014486469325
7	ECCENTRIC SHAFT DRIVE	41982400	1	1003501	4014486469059
8	STRAW SHAKER CRANK - GRAIN AUGER	41990100	1	1001377	4014486474916
9	INTERMEDIATE SHAFT	41987200	1	1003518	4014486469714
10	STRIPPER BEATER	41935200	1	1000318	4014486465372
11	COUNTERSHAFT DRIVE	41993400	1	1003633	4014486488609
12	HYDRAULIC PUMP DRIVE	41928900	1	1000249	4014486463828
12	HYDRAULIC PUMP DRIVE	41929000	1	1000251	4014486463897
12	HYDRAULIC PUMP DRIVE	41929200	1	1003424	4014486463996
12	HYDRAULIC PUMP DRIVE	41930200	1	1000260	4014486464108
12	HYDRAULIC PUMP DRIVE	D41929000	1	1000251	4014486463897
13	COUNTER DRIVE STRAW CHOPPER	41942100	1	1000404	4014486466676
14	STRAW CHOPPER DRIVE	41987300	1	1000815	4014486472400
15	AWNER SHAFT	41912400	1	1003381	4014486461732
16	THRESHING DRUM VARIATOR DRIVE	41999200	1	1004068	4014486518375
18	DISCHARGE AUGER SHAFT	41935900	1	1000328	4014486465587
18	DISCHARGE AUGER SHAFT	41936200	2	1002770	4014486465648
20	STRIPPER BEATER	41982400	1	1003501	4014486469059
25	MAIN FAN SELECTOR - MAIN FAN	41982200	1	1003499	4014486469004
26	COUNTER DRIVE RADIATOR	41905300	1	1000114	4014486461220
27	COUNTER DRIVE RADIATOR	41911000	1	1000143	4014486461619

### D 7000 S

1	FEEDER DRUM	41983500	1	1000611	4014486469493
2	CRANKSHAFT	41964300	1	1003405	4014486463309
3	COUNTERSHAFT DRIVE	41993000	1	1001104	4014486496864
5		41950600	1	1003524	4014486469998

AG - BI  
 CA - CL  
 DE - DR  
 FE - FO  
 GO - GR  
 IN - JO  
 KP - KZ  
 LA - ME  
 NE - RO  
 SA - ST  
 VA - ZM  
 PARTS  
 SERVICE

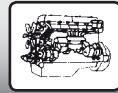
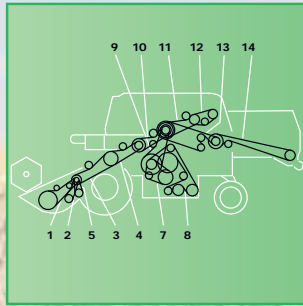
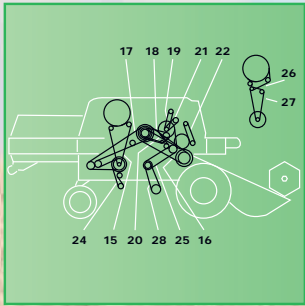

## DRONNINGBORG

6		41950900	1	1000600	4014486469325
7	ECCENTRIC SHAFT DRIVE	41982400	1	1003501	4014486469059
8	STRAW SHAKER CRANK - GRAIN AUGER	41990100	1	1001377	4014486474916
9	INTERMEDIATE SHAFT	41987200	1	1003518	4014486469714
10	STRIPPER BEATER	41935200	1	1000318	4014486465372
11	COUNTERSHAFT DRIVE	41993400	1	1003633	4014486488609
12	HYDRAULIC PUMP DRIVE	41928900	1	1000249	4014486463828
12	HYDRAULIC PUMP DRIVE	41929000	1	1000251	4014486463897
12	HYDRAULIC PUMP DRIVE	41929200	1	1003424	4014486463996
12	HYDRAULIC PUMP DRIVE	41930200	1	1000260	4014486464108
12	HYDRAULIC PUMP DRIVE	D41929000	1	1000251	4014486463897
13	COUNTER DRIVE STRAW CHOPPER	41942100	1	1000404	4014486466676
14	STRAW CHOPPER DRIVE	41987300	1	1000815	4014486472400
15	AWNER SHAFT	41912400	1	1003381	4014486461732
16	THRESHING DRUM VARIATOR DRIVE	41999200	1	1004068	4014486518375
18	DISCHARGE AUGER SHAFT	41935900	1	1000328	4014486465587
18	DISCHARGE AUGER SHAFT	41936200	2	1002770	4014486465648
20	STRIPPER BEATER	41982400	1	1003501	4014486469059
25	MAIN FAN SELECTOR - MAIN FAN	41982200	1	1003499	4014486469004
26	COUNTER DRIVE RADIATOR	41905300	1	1000114	4014486461220
27	COUNTER DRIVE RADIATOR	41911000	1	1000143	4014486461619

### D 7200

1	FEEDER DRUM	41983500	1	1000611	4014486469493
1	FEEDER DRUM	41983600	1	1000611	4014486469493
2	CRANKSHAFT	41963900	1	1000233	4014486463293
2	CRANKSHAFT	41964300	1	1003405	4014486463309
3	COUNTERSHAFT DRIVE	41989200	1	1000908	4014486473568
3	COUNTERSHAFT DRIVE	41989400	1	1000911	4014486473605
4	FEEDER SHAFT (UPPER)	41991700	1	1001844	4014486488739
7	ECCENTRIC SHAFT DRIVE	41982400	1	1003501	4014486469059
7	ECCENTRIC SHAFT DRIVE	41982500	1	1000585	4014486469066
8	STRAW SHAKER CRANK - GRAIN AUGER	41990100	1	1001377	4014486474916
8	STRAW SHAKER CRANK	41990400	1	1003581	4014486474930
9	INTERMEDIATE SHAFT	41987800	1	1000620	4014486469608
9	INTERMEDIATE SHAFT	41988000	1	1000698	4014486470802
10	STRIPPER BEATER	41934800	3	1002768	4014486465228
11	COUNTER SELECTOR	41993400	1	1003633	4014486488609
12	HYDRAULIC PUMP DRIVE	41929000	1	1000251	4014486463897
12	HYDRAULIC PUMP DRIVE	41930200	1	1000260	4014486464108
12	HYDRAULIC PUMP DRIVE	D41929000	1	1000251	4014486463897
13	COUNTER DRIVE STRAW CHOPPER	41942100	1	1000404	4014486466676
14	STRAW CHOPPER DRIVE	41987300	1	1000815	4014486472400
15	AWNER SHAFT	41912300	1	1003380	4014486461749
15	AWNER SHAFT	41912400	1	1003381	4014486461732
17	FAN SHAFT AWNER SHAFT	41990400	1	1003581	4014486474930
18	DISCHARGE AUGER SHAFT	41936200	2	1002770	4014486465648
20	STRIPPER BEATER	41982500	1	1000585	4014486469066
25	MAIN FAN SELECTOR	41987900	1	1000575	4014486468847
26	COUNTER DRIVE RADIATOR	41905300	1	1000114	4014486461220
27	COUNTER DRIVE RADIATOR	41911000	1	1000143	4014486461619
28	MAIN FAN	41982100	1	1000582	4014486469011
28	MAIN FAN	41982200	1	1003499	4014486469004
28	MAIN FAN	41987900	1	1000575	4014486468847



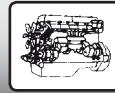
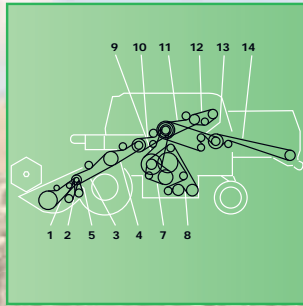
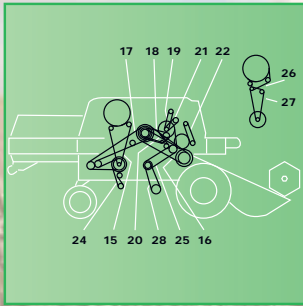

# DRONNINGBORG

## D 7500

1	FEEDER DRUM	41983500	1	1000611	4014486469493
1	FEEDER DRUM	41983600	1	1000611	4014486469493
2	CRANKSHAFT	41963900	1	1000233	4014486463293
2	CRANKSHAFT	41964300	1	1003405	4014486463309
3	COUNTERSHAFT DRIVE	41989200	1	1000908	4014486473568
3	COUNTERSHAFT DRIVE	41989400	1	1000911	4014486473605
4	FEEDER SHAFT (UPPER)	41991700	1	1001844	4014486488739
7	ECCENTRIC SHAFT DRIVE	41982400	1	1003501	4014486469059
7	ECCENTRIC SHAFT DRIVE	41982500	1	1000585	4014486469066
8	STRAW SHAKER CRANK - GRAIN AUGER	41990100	1	1001377	4014486474916
8	STRAW SHAKER CRANK - GRAIN AUGER	41990400	1	1003581	4014486474930
9	INTERMEDIATE SHAFT	41987800	1	1000620	4014486469608
9	INTERMEDIATE SHAFT	41988000	1	1000698	4014486470802
10	STRIPPER BEATER	41934800	3	1002768	4014486465228
11	COUNTERSHAFT DRIVE	41993400	1	1003633	4014486488609
12	ENGINE - HYDRAULIC PUMP	41929000	1	1000251	4014486463897
12	HYDRAULIC PUMP DRIVE	41930200	1	1000260	4014486464108
12	ENGINE - HYDRAULIC PUMP	D41929000	1	1000251	4014486463897
13	COUNTER DRIVE STRAW CHOPPER	41942100	1	1000404	4014486466676
14	STRAW CHOPPER DRIVE	41987300	1	1000815	4014486472400
15	AWNER SHAFT	41912300	1	1003380	4014486461749
15	AWNER SHAFT	41912400	1	1003381	4014486461732
16	THRESHING DRUM VARIATOR DRIVE	41980900	1	1001526	4014486460452
16	THRESHING DRUM VARIATOR DRIVE	D41980900	1	1001526	4014486460452
17	FAN SHAFT AWNER SHAFT	41990400	1	1003581	4014486474930
18	DISCHARGE AUGER SHAFT	41936200	2	1002770	4014486465648
20	STRIPPER BEATER	41982500	1	1000585	4014486469066
25	MAIN FAN SELECTOR	41987900	1	1000575	4014486468847
26	COUNTER DRIVE RADIATOR	41905300	1	1000114	4014486461220
27	COUNTER DRIVE RADIATOR	41911000	1	1000143	4014486461619
28	MAIN FAN SELECTOR - MAIN FAN	41982100	1	1000582	4014486469011
28	MAIN FAN	41982200	1	1003499	4014486469004
28	MAIN FAN	41987900	1	1000575	4014486468847

## D 8000

1	FEEDER DRUM	41983500	1	1000611	4014486469493
1	FEEDER DRUM	41983600	1	1000611	4014486469493
2	CRANKSHAFT	41964300	1	1003405	4014486463309
3	COUNTERSHAFT DRIVE	41993000	1	1001104	4014486496864
5		41950600	1	1003524	4014486469998
6		41950900	1	1000600	4014486469325
7	ECCENTRIC SHAFT DRIVE	41982400	1	1003501	4014486469059
8	STRAW SHAKER CRANK - GRAIN AUGER	41990100	1	1001377	4014486474916
9	INTERMEDIATE SHAFT	41987200	1	1003518	4014486469714
10	STRIPPER BEATER	41935200	1	1000318	4014486465372
11	COUNTER SELECTOR	41993400	1	1003633	4014486488609
12	HYDRAULIC PUMP DRIVE	41929000	1	1000251	4014486463897
12	HYDRAULIC PUMP DRIVE	41930200	1	1000260	4014486464108
12	HYDRAULIC PUMP DRIVE	41930300	1	1003426	4014486464092
12	HYDRAULIC PUMP DRIVE	D41929000	1	1000251	4014486463897
13	COUNTER DRIVE STRAW CHOPPER	41942100	1	1000404	4014486466676
14	STRAW CHOPPER DRIVE	41987600	1	1000853	4014486472844
15	AWNER SHAFT	41912400	1	1003381	4014486461732

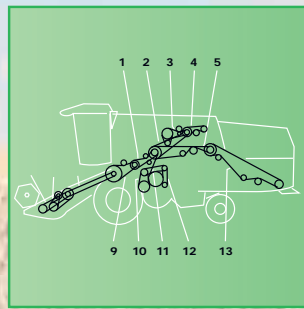
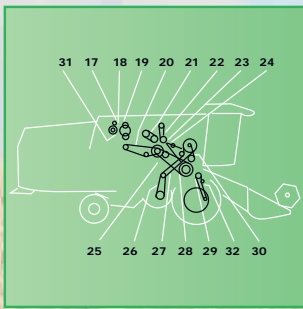

## DRONNINGBORG

16	THRESHING DRUM VARIATOR DRIVE	41999200	1	1004068	4014486518375
18	DISCHARGE AUGER SHAFT	41935900	1	1000328	4014486465587
18	DISCHARGE AUGER SHAFT	41936200	2	1002770	4014486465648
20	STRIPPER BEATER	41982400	1	1003501	4014486469059
25	MAIN FAN SELECTOR	41982200	1	1003499	4014486469004
26	COUNTER DRIVE RADIATOR	41905300	1	1000114	4014486461220
27	COUNTER DRIVE RADIATOR	41911000	1	1000143	4014486461619

### D 8000 S

1	FEEDER DRUM	41983500	1	1000611	4014486469493
1	FEEDER DRUM	41983600	1	1000611	4014486469493
2	CRANKSHAFT	41964300	1	1003405	4014486463309
3	COUNTERSHAFT DRIVE	41993000	1	1001104	4014486496864
5		41950600	1	1003524	4014486469998
6		41950900	1	1000600	4014486469325
7	ECCENTRIC SHAFT DRIVE	41982400	1	1003501	4014486469059
8	STRAW SHAKER CRANK - GRAIN AUGER	41990100	1	1001377	4014486474916
9	INTERMEDIATE SHAFT	41987200	1	1003518	4014486469714
10	STRIPPER BEATER	41935200	1	1000318	4014486465372
11	COUNTER SELECTOR	41993400	1	1003633	4014486488609
12	HYDRAULIC PUMP DRIVE	41929000	1	1000251	4014486463897
12	HYDRAULIC PUMP DRIVE	41930200	1	1000260	4014486464108
12	HYDRAULIC PUMP DRIVE	41930300	1	1003426	4014486464092
12	HYDRAULIC PUMP DRIVE	D41929000	1	1000251	4014486463897
13	COUNTER DRIVE STRAW CHOPPER	41942100	1	1000404	4014486466676
14	STRAW CHOPPER DRIVE	41987600	1	1000853	4014486472844
15	AWNER SHAFT	41912400	1	1003381	4014486461732
16	THRESHING DRUM VARIATOR DRIVE	41999200	1	1004068	4014486518375
18	DISCHARGE AUGER SHAFT	41935900	1	1000328	4014486465587
18	DISCHARGE AUGER SHAFT	41936200	2	1002770	4014486465648
20	STRIPPER BEATER	41982400	1	1003501	4014486469059
25	MAIN FAN SELECTOR	41982200	1	1003499	4014486469004
26	COUNTER DRIVE RADIATOR	41905300	1	1000114	4014486461220
27	COUNTER DRIVE RADIATOR	41911000	1	1000143	4014486461619

### D 8400

1	STRIPPER BEATER	41934800	3	1002768	4014486465228
2	COUNTERSHAFT DRIVE	41990051	1	1001877	4014486489255
3	DISCHARGE AUGER SHAFT	41990050	1	1003600	4014486485196
5	INTERMEDIATE SHAFT - STRAW CHOPPER	41942200	1	1000410	4014486466737
6	KNIFE DRIVE	41985600	1	1000693	4014486470741
9	FEEDER SHAFT (UPPER)	41991700	1	1001844	4014486488739
10	ECCENTRIC SHAFT DRIVE	41982100	1	1000582	4014486469011
11	INTERMEDIATE SHAFT	41984100	1	1000655	4014486470185
12	STRAW SHAKER CRANK	41990068	1	1001368	4014486474824
13	STRAW CHOPPER DRIVE	41978400	1	1001725	4014486487084
17	AIR CONDITIONING COMPRESSOR DRIVE	41909000	1	1003748	4014486496048
17	AIR CONDITIONING COMPRESSOR DRIVE	41991000	1	1002346	4014486478792
19	SUCTION STRAINER	41990009	1	1002357	4014486478907
20	DUST EXTRACTOR	41936700	1	1000327	4014486465556
21	DISCHARGE AUGER SHAFT	41979600	1	1003347	4014486486285
23	INTERMEDIATE SHAFT - FILL ELEVATOR	41950100	1	1000627	4014486469776
25	COUNTERSHAFT - GRAIN SEPARATOR	41982100	1	1000582	4014486469011
26	MAIN FAN	41982100	1	1000582	4014486469011
27	MAIN FAN VARIABLE SPEED DRIVE	41987900	1	1000575	4014486468847

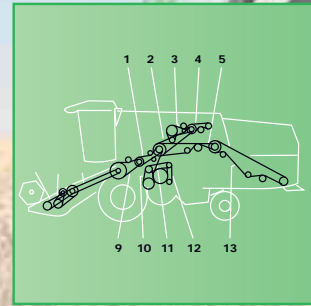
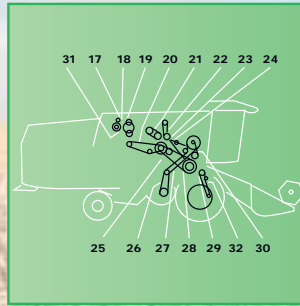
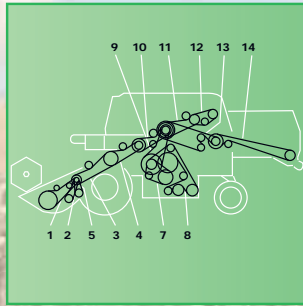
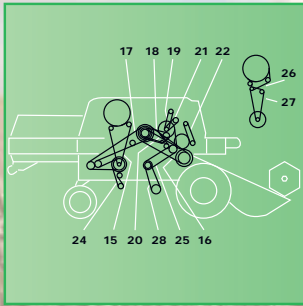

# DRONNINGBORG

28	THRESHING DRUM VARIATOR DRIVE	41980900	1	1001526	4014486460452
28	THRESHING DRUM VARIATOR DRIVE	D41980900	1	1001526	4014486460452
29	DISCHARGE AUGER SHAFT	41950400	1	1003517	4014486469691

## D 8500

1	FEEDER DRUM	41983500	1	1000611	4014486469493
1	FEEDER DRUM	41983600	1	1000611	4014486469493
2	CRANKSHAFT	41963900	1	1000233	4014486463293
2	CRANKSHAFT	41964300	1	1003405	4014486463309
3	COUNTERSHAFT DRIVE	41989200	1	1000908	4014486473568
3	COUNTERSHAFT DRIVE	41989400	1	1000911	4014486473605
4	FEEDER SHAFT (UPPER)	41991700	1	1001844	4014486488739
7	ECCENTRIC SHAFT DRIVE	41982400	1	1003501	4014486469059
7	ECCENTRIC SHAFT DRIVE	41982500	1	1000585	4014486469066
8	STRAW SHAKER CRANK	41990069	1	1001378	4014486474923
8	STRAW SHAKER CRANK - GRAIN AUGER	41990100	1	1001377	4014486474916
8	STRAW SHAKER CRANK	41990400	1	1003581	4014486474930
9	INTERMEDIATE SHAFT	41987800	1	1000620	4014486469608
9	INTERMEDIATE SHAFT	41988000	1	1000698	4014486470802
10	STRIPPER BEATER	41934800	3	1002768	4014486465228
11	COUNTER SELECTOR	41991300	1	1001836	4014486488616
11	COUNTER SELECTOR	41993400	1	1003633	4014486488609
12	HYDRAULIC PUMP DRIVE	41930200	1	1000260	4014486464108
13	COUNTER DRIVE STRAW CHOPPER	41942100	1	1000404	4014486466676
14	STRAW CHOPPER DRIVE	41987300	1	1000815	4014486472400
15	AWNER SHAFT	41912300	1	1003380	4014486461749
15	AWNER SHAFT	41912400	1	1003381	4014486461732
17	FAN SHAFT AWNER SHAFT	41990069	1	1001378	4014486474923
18	DISCHARGE AUGER SHAFT	41936200	2	1002770	4014486465648
20	STRIPPER BEATER	41982400	1	1003501	4014486469059
25	MAIN FAN SELECTOR	41987900	1	1000575	4014486468847
26	COUNTER DRIVE RADIATOR	41905300	1	1000114	4014486461220
27	COUNTER DRIVE RADIATOR	41911000	1	1000143	4014486461619
28	MAIN FAN SELECTOR - MAIN FAN	41982100	1	1000582	4014486469011
28	MAIN FAN SELECTOR - MAIN FAN	41982200	1	1003499	4014486469004
28	MAIN FAN SELECTOR - MAIN FAN	41987900	1	1000575	4014486468847

## D 8700

1	STRIPPER BEATER	41934800	3	1002768	4014486465228
2	COUNTERSHAFT DRIVE	41990051	1	1001877	4014486489255
3	DISCHARGE AUGER SHAFT	41990050	1	1003600	4014486485196
5	INTERMEDIATE SHAFT - STRAW CHOPPER	41942200	1	1000410	4014486466737
6	KNIFE DRIVE	41985600	1	1000693	4014486470741
9	FEEDER SHAFT (UPPER)	41991700	1	1001844	4014486488739
10	ECCENTRIC SHAFT DRIVE	41982100	1	1000582	4014486469011
11	INTERMEDIATE SHAFT	41984100	1	1000655	4014486470185
12	STRAW SHAKER CRANK	41990068	1	1001368	4014486474824
13	STRAW CHOPPER DRIVE	41978400	1	1001725	4014486487084
17	AIR CONDITIONING COMPRESSOR DRIVE	41909000	1	1003748	4014486496048
17	AIR CONDITIONING COMPRESSOR DRIVE	41991000	1	1002346	4014486478792
19	SUCTION STRAINER	41990009	1	1002357	4014486478907
20	DUST EXTRACTOR	41936700	1	1000327	4014486465556
21	DISCHARGE AUGER SHAFT	41979600	1	1003347	4014486486285
23	INTERMEDIATE SHAFT - FILL ELEVATOR	41950100	1	1000627	4014486469776
25	COUNTERSHAFT - GRAIN SEPARATOR	41982100	1	1000582	4014486469011



## DRONNINGBORG

26	MAIN FAN	41982100	1	1000582	4014486469011
27	MAIN FAN VARIABLE SPEED DRIVE	41987900	1	1000575	4014486468847
28	THRESHING DRUM VARIATOR DRIVE	41980900	1	1001526	4014486460452
28	THRESHING DRUM VARIATOR DRIVE	D41980900	1	1001526	4014486460452
29	DISCHARGE AUGER SHAFT	41950400	1	1003517	4014486469691

### D 8900

1		41933700	2	1002760	4014486464993
2		41979400	1	1001251	4014486492071
3		41979100	1	1001607	4014486485332
5		41979600	1	1003347	4014486486285
6		41978900	1	1001730	4014486487145
7		41983500	1	1000611	4014486469493
7		41983600	1	1000611	4014486469493
8		41963900	1	1000233	4014486463293
11		41979800	1	1001990	4014486491104
12		41990001	1	1002212	4014486477634
14		41979000	1	1001632	4014486485776
17		41911000	1	1000143	4014486461619
19		41986100	1	1000675	4014486470475
19		D41986100	1	1000675	4014486470475
20		41998800	1	1000278	4014486464528
22		41937500	2	1002773	4014486465891
23		41978800	1	1001683	4014486486544
27		41981200	1	1001427	4014486459357
27		D41981200	1	1001427	4014486459357
28		41981100	1	1001436	4014486459449
28		D41981100	1	1001436	4014486459449
29		41981000	1	1001539	4014486460582
30		41985200	1	1000603	4014486469370
31		41985300	1	1003514	4014486469622

### D 900

1	ENGINE	41998700	1	No AP	
1	ENGINE	D41998700	1	No AP	
2	COUNTERSHAFT (PRIMARY)	41996400	1	1002071	4014486475579
3	HYDRAULIC PUMP DRIVE	41922200	1	1000186	4014486462159
4	GEAR BOX	41994300	1	1001215	4014486497748
5	REEL DRIVE - VARIATOR PULLEY	41962000	1	1000192	4014486462234
6	REEL DRIVE	41939300	1	1000366	4014486466287
7		41926100	1	1000224	4014486462913
8	COUNTERSHAFT DRIVE	41903000	1	1000089	4014486460865
9	FEEDER AUGER	41982400	1	1003501	4014486469059
10	MAIN BLOWER SHAKER BEATER	41974300	1	1001357	4014486474718
11	FILLING AUGER	41938900	1	1000356	4014486466133
12	THRESHING DRUM/FAN	41974300	1	1001357	4014486474718
14	BEATER RETURN ELEVATOR	41932800	1	1003437	4014486464818
14	BEATER RETURN ELEVATOR	D41932800	1	1003437	4014486464818
15		41904900	1	1000112	4014486461183
17	COUNTERSHAFT DRIVE	41954800	1	1003537	4014486470611
18	COUNTERSHAFT DRIVE	41995700	1	1001429	4014486459371
18	COUNTERSHAFT DRIVE	D41995700	1	1001429	4014486459371
19	DRIVING GEAR FOR AUGER	41955800	1	1000757	4014486471588
20		41962600	1	1000201	4014486462395

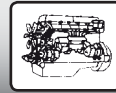
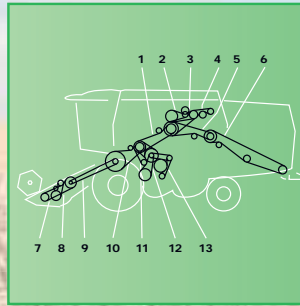
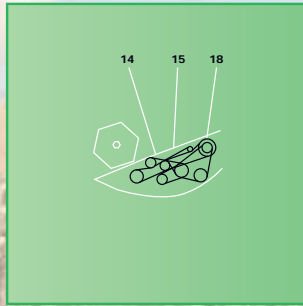
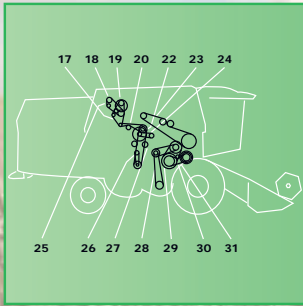

# DRONNINGBORG

## D 9000

1	COUNTERSHAFT DRIVE	41979900	1	1003576	4014486492217
2	DISCHARGE AUGER SHAFT	41979400	1	1001251	4014486492071
3	DIESEL ENGINE	41979100	1	1001607	4014486485332
5	INTERMEDIATE SHAFT - STRAW CHOPPER	41979600	1	1003347	4014486486285
6	STRAW CHOPPER DRIVE	41978900	1	1001730	4014486487145
7	KNIFE DRIVE	41985600	1	1000693	4014486470741
10	FEEDER SHAFT (UPPER)	41979800	1	1001990	4014486491104
11	STRIPPER BEATER	41990001	1	1002212	4014486477634
12	ECCENTRIC SHAFT - INTERMEDIATE SHAFT	41933700	2	1002760	4014486464993
13	STRAW SHAKER CRANK	41979000	1	1001632	4014486485776
14	KNIFE DRIVE	41986300	1	1000756	4014486471571
17	DIESEL ENGINE	41911000	1	1000143	4014486461619
19	INTERMEDIATE SHAFT - FILL ELEVATOR	41986100	1	1000675	4014486470475
19	INTERMEDIATE SHAFT - FILL ELEVATOR	D41986100	1	1000675	4014486470475
20	DUST EXTRACTOR - COUNTERSHAFT	41998800	1	1000278	4014486464528
22	COUNTERSHAFT DRIVE	41937500	2	1002773	4014486465891
23	DISCHARGE AUGER SHAFT	41978800	1	1001683	4014486486544
25	AIR CONDITIONING COMPRESSOR DRIVE	41909000	1	1003748	4014486496048
27	MAIN FAN RADIATOR	41981200	1	1001427	4014486459357
27	MAIN FAN RADIATOR	D41981200	1	1001427	4014486459357
28	MAIN FAN	41981100	1	1001436	4014486459449
28	MAIN FAN	D41981100	1	1001436	4014486459449
29	INTERMEDIATE SHAFT - VARIATOR DRIVE	41981000	1	1001539	4014486460582
30	INTERMEDIATE SHAFT - VARIATOR DRIVE	41985200	1	1000603	4014486469370
31	THRESHING DRUM VARIATOR DRIVE	41985300	1	1003514	4014486469622

## D 950

1	ENGINE	41998700	1	No AP	
1	ENGINE	D41998700	1	No AP	
2	COUNTERSHAFT (PRIMARY)	41996400	1	1002071	4014486475579
3	HYDRAULIC PUMP DRIVE	41922200	1	1000186	4014486462159
4	GEAR BOX	41994300	1	1001215	4014486497748
5	REEL DRIVE - VARIATOR PULLEY	41962000	1	1000192	4014486462234
6	REEL DRIVE	41939300	1	1000366	4014486466287
7		41926100	1	1000224	4014486462913
8	COUNTERSHAFT DRIVE	41903000	1	1000089	4014486460865
9	FEEDER AUGER	41982400	1	1003501	4014486469059
10	MAIN BLOWER SHAKER BEATER	41974300	1	1001357	4014486474718
11	FILLING AUGER	41938900	1	1000356	4014486466133
12	THRESHING DRUM/FAN	41974300	1	1001357	4014486474718
14	BEATER RETURN ELEVATOR	41932800	1	1003437	4014486464818
14	BEATER RETURN ELEVATOR	D41932800	1	1003437	4014486464818
15		41904900	1	1000112	4014486461183
17	COUNTERSHAFT DRIVE	41954800	1	1003537	4014486470611
18	COUNTERSHAFT DRIVE	41995700	1	1001429	4014486459371
18	COUNTERSHAFT DRIVE	D41995700	1	1001429	4014486459371
19	DRIVING GEAR FOR AUGER	41955800	1	1000757	4014486471588
20		41962600	1	1000201	4014486462395

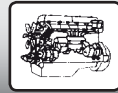

# DRONNINGBORG

<b>MF 27</b>					
2	CRANKSHAFT - COUNTERSHAFT	41964300	1	1003405	4014486463309
<b>MF 29</b>					
2	CRANKSHAFT - COUNTERSHAFT	41964300	1	1003405	4014486463309
<b>MF 30</b>					
20	DUST EXTRACTOR - COUNTERSHAFT	41936700	1	1000327	4014486465556
<b>MF 31</b>					
2	COUNTERSHAFT - CRANKSHAFT	41964300	1	1003405	4014486463309
<b>MF 32</b>					
20	DUST EXTRACTOR - COUNTERSHAFT	41936700	1	1000327	4014486465556
<b>MF 38</b>					
2	COUNTERSHAFT (DIESEL ENGINE)	41979400	1	1001251	4014486492071
22	COUNTERSHAFT DRIVE	41937500	2	1002773	4014486465891



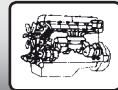

## FENDT

### 5250

1		340433422	1	1000606	4014486520514
2		340433253	1	1000231	4014486520491
2		LA340433253	1	1000231	4014486520491
3		340433197	1	1000164	4014486461879
4		344311227	1	1001820	4014486488371
4		LA344311227	1	1001820	4014486488371
5		344312128	1	1003623	4014486487503
5		LA344312128	1	1003623	4014486487503
6		LA340433984	1	1001346	4014486474596
6		LA340433984	1	1001346	4014486474596
7		340435152	1	1001539	4014486460582
7		LA340435152	1	1001539	4014486460582
8		344311318	1	1002000	4014486491265
8		LA344311318	1	1002000	4014486491265
9		340433539	1	1001120	4014486497069
9		LA340433539	1	1001120	4014486497069
10		340433474	1	1000789	4014486472059
10		LA340433474	1	1000789	4014486472059
11		344311131	1	1001640	4014486485929
11		LA344311131	1	1001640	4014486485929
12		344311151	1	1001717	4014486486995
13		344311123	1	1001622	4014486485554
13		LA344311123	1	1001622	4014486485554
14		340435150	1	1001422	4014486459296
14		LA340435150	1	1001422	4014486459296
15		344311117	1	1003592	4014486484939
15		LA344311117	1	1003592	4014486484939
16		340433154	1	1003374	4014486461343
16		LA340433154	1	1003374	4014486461343
17		340433253	1	1000231	4014486520491
17		LA340433253	1	1000231	4014486520491
18		340434138	1	1001061	4014486496451
18		LA340434138	1	1001061	4014486496451
19		340433423	1	1000613	4014486469509

### 6300

1	DRUM DRIVE	41979900	1	1003576	4014486492217
2	THRESHING DRUM VARIATOR DRIVE	41978000	1	1001304	4014486492620
3	DISPOSAL SHAFT DRIVE	41978100	1	1003606	4014486485639
4	THRESHER DRIVE (SECONDARY)	41937800	2	1002774	4014486465815
5	MOVEMENT DRIVE	41990057	1	1003659	4014486490503
6	CRUSHER DRIVE	41979600	1	1003347	4014486486285

### 6330

1	DRUM DRIVE	41979900	1	1003576	4014486492217
2	THRESHING DRUM VARIATOR DRIVE	41978000	1	1001304	4014486492620
3	DISPOSAL SHAFT DRIVE	41978100	1	1003606	4014486485639
4	THRESHER DRIVE (SECONDARY)	41937800	2	1002774	4014486465815
5	MOVEMENT DRIVE	41990057	1	1003659	4014486490503
6	CRUSHER DRIVE	41979600	1	1003347	4014486486285





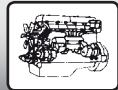
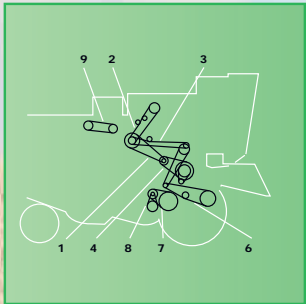

## FORTSCHRITT

		4270722244	1	1001513	4014486460322
		9911860628	2	1002881	4014486469554
		9911860628	2	1002881	4014486469554
		06014350	2	1003003	4014486476415
		061011077	1	1002153	4014486476712
		4250129747	1	1003314	4014486477832
		4254138832	1	1002185	4014486477290
		4254138832	1	1002185	4014486477290
		4254138832	1	1002185	4014486477290
		4254138832	1	1002185	4014486477290
		4260700023	2	1003007	4014486476941
		4260700023	2	1003007	4014486476941

### E 514

10		4250121764	1	1003650	4014486489354
16		4250121780	1	1001663	4014486486193

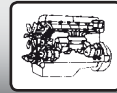
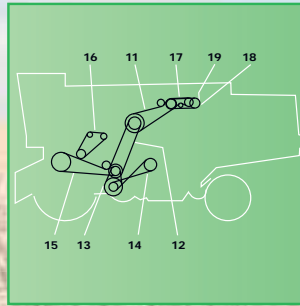
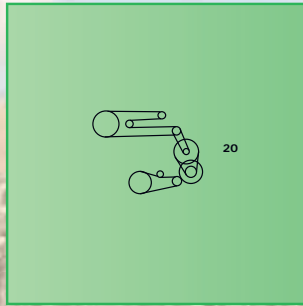
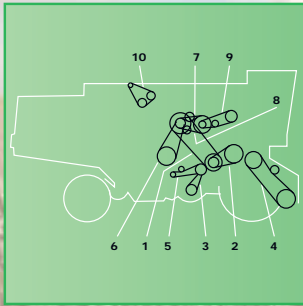

## FORTSCHRITT

### E 516

1		4240023362	1	1001207	4014486497663
2		4240023387	1	1001956	4014486490633
3		4240023354	1	1001000	4014486497236
4		4240023395	1	1003652	4014486489491
5		4240044287	1	1002079	4014486475692
6		4240044295	1	1003680	4014486477061
6		4250121772	1	1001617	4014486485479
7		4240044301	1	1002148	4014486476637
8		4240044246	2	1002881	4014486469554
9		4240044270	2	1003005	4014486476729
10		9911861645	1	1002076	4014486475654
11		4240023370	1	1001990	4014486491104
12		4240044254	2	1002231	4014486477931
13		4240046545	2	1002989	4014486475593
14		4240040388	1	1002185	4014486477290
15		4240023395	1	1003652	4014486489491
16		4240044301	1	1002148	4014486476637
17		4240044262	2	1002131	4014486476361
19		4240043405	2	1003779	4014486476408
20		4240043413	1	1002142	4014486476545

### E 516 B

1		4240023362	1	1001207	4014486497663
2		4240023387	1	1001956	4014486490633
3		4240023354	1	1001000	4014486497236
4		4240023395	1	1003652	4014486489491
5		4240044287	1	1002079	4014486475692
6		4240044295	1	1003680	4014486477061
7		4240044301	1	1002148	4014486476637
8		4240044246	2	1002881	4014486469554
9		4240044270	2	1003005	4014486476729
11		4240023370	1	1001990	4014486491104
12		4240044254	2	1002231	4014486477931
13		4240046545	2	1002989	4014486475593
14		4240040388	1	1002185	4014486477290
15		4240023395	1	1003652	4014486489491
16		4240044301	1	1002148	4014486476637
17		4240044262	2	1002131	4014486476361
19		4240043405	2	1003779	4014486476408
20		4240043413	1	1002142	4014486476545

### E 517

1		4240023362	1	1001207	4014486497663
2		4240023387	1	1001956	4014486490633
3		4240023354	1	1001000	4014486497236
4		4240023395	1	1003652	4014486489491
5		4240044287	1	1002079	4014486475692
6		4240044295	1	1003680	4014486477061
7		4240044301	1	1002148	4014486476637
8		4240044246	2	1002881	4014486469554
9		4240044270	2	1003005	4014486476729
11		4240023370	1	1001990	4014486491104
12		4240044254	2	1002231	4014486477931

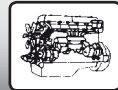
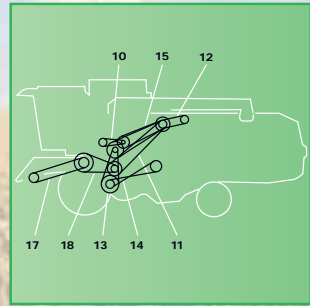
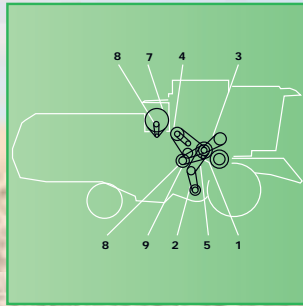
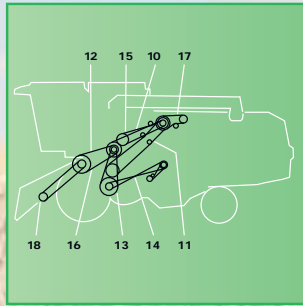
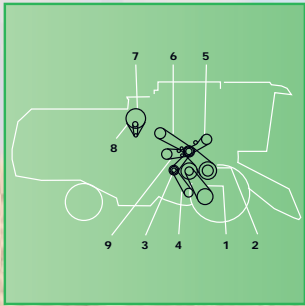

## FORTSCHRITT

13		4240046545	2	1002989	4014486475593
14		4240040388	1	1002185	4014486477290
15		4240023395	1	1003652	4014486489491
16		4240044301	1	1002148	4014486476637
17		4240044262	2	1002131	4014486476361
19		4240043405	2	1003779	4014486476408
20		4240043413	1	1002142	4014486476545

### E 524

10		4260699985	1	1001901	4014486489613
11		4260699960	1	1001915	4014486489811
15		4260699977	1	1001649	4014486486018
16		4260703942	1	1001869	4014486489095
16		4260703942	1	1001869	4014486489095
18		4260715183	1	1001892	4014486489507

### E 525

10		4260699985	1	1001901	4014486489613
11		4260699960	1	1001915	4014486489811
15		4260699977	1	1001649	4014486486018
18		4260715183	1	1001892	4014486489507

### E 527

10		61020978	1	1001900	4014486489606
11		60168160	1	1003348	4014486489743
16		61009074	1	1001858	4014486488937
17		61004680	1	1002002	4014486491289

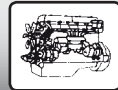

## GOMSELMASH

16		3-HB 3350	1	1001869	4014486489095
16		3-HB 3350 A	1	1001869	4014486489095
		3-HB 2907	1	1003294	4014486488845
		13x1230	1	1000110	4014486461145
		13x3030	1	1003857	4014486520736
		13x3580	1	1003930	4014486462012
		14x10x887	1	1003942	4014486521153
		14x10x937	1	1003934	4014486519259
		16x11x1650	1	1003932	4014486467697
		17x1220	1	1000206	4014486462463
		17x1790	1	1003419	4014486463699
		17x1890	1	1003862	4014486463934
		17x1890 A	1	1000252	4014486463941
		17x2950	1	1000336	4014486465792
		22x5000	1	1004192	4014486558425
		2-HB 4062	1	1004262	4014486683080
		2-HB 4062 "K"	1	1004262	4014486683080
		2-HBx1912	1	1003872	4014486484670
		2-HBx2162	1	1001582	4014486484892
		2-HBx2362	1	1003599	4014486485110
		2-HBx2362 A	1	1003873	4014486485127
		2-HBx2512	1	1003961	4014486485264
		2-HBx2512 A	1	1003875	4014486485271
		2-HBx2512 AA	1	1003876	4014486485288
		2-HBx2662	1	1003877	4014486485370
		2-HBx2907	1	1003878	4014486485585
		2-HBx2962	1	1003962	4014486485608
		2-HBx2962 A	1	1003879	4014486485615
		2-HBx3110	1	1003607	4014486485721
		2-HBx3110 A	1	1001630	4014486485738
		2-HBx3212	1	1003882	4014486485790
		2-HBx3212 A	1	1003883	4014486485806
		2-HBx3812	1	1001663	4014486486193
		2-HBx3812 A	1	1003885	4014486486209
		2-HBx4812	1	1003887	4014486486568
		2-HBx4812 A	1	1003888	4014486486575
		38x18x1500	1	1001003	4014486497267
		3-HB 1900	1	1004264	4014486683141
		3-HBx2162	1	1001814	4014486488272
		3-HBx2162 A	1	1003890	4014486488289
		3-HBx2662 A	1	1003892	4014486488678
		3-HBx2886	1	1004080	4014486520538
		3-HBx3612	1	1003894	4014486489217
		3-HBx3762	1	1003649	4014486489323
		3-HBx3812	1	1003929	4014486489361
		3-HBx3812 A	1	1003895	4014486489378
		3-HBx4985	1	1003965	4014486489781
		3-HBx4985 A	1	1003897	4014486489798
		4-HA2886 A	1	1004191	4014486558265
		4-HAx2240	1	1004190	4014486558258
		4-HB 2500	1	1004263	4014486683202
		4-HB 2500 K	1	1004263	4014486683202
		4-HBx1912	1	1003928	4014486490466
		4-HBx3612	1	1002726	4014486491142
		4-HBx4562	1	1003904	4014486491456

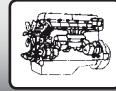

## GOMSELMASH

		4-HBx4562 A	1	1003905	4014486491463
		52x16x1250	1	1004187	4014486554403
		5-HBx3612 A	1	1003907	4014486492163
		5-HBx3812	1	1003963	4014486492248
		5-HBx3812 A	1	1003909	4014486492255
		68x24x2600	1	1001291	4014486497885
		68x24x2600 A	1	1004085	4014486520477
		7-HBx9100 AA	1	1003912	4014486492873
		8-SPCx2240	1	1003956	4014486497335
		alternative Gomselmash	1	1003870	4014486472257
		B95.02297	1	1000323	4014486465471
		HB 2990	1	1003859	4014486465730
		SPA 1157	1	1002049	4014486475258
		SPAx1032	1	1003913	4014486475203
		SPAx1120	1	1002046	4014486475227
		SPAx1400	1	1003914	4014486475388
		SPBx1250	1	1002110	4014486476071
		SPBx1500	1	1002117	4014486476170
		SPBx1800	1	1002127	4014486476309
		SPBx2240	1	1003677	4014486476620
		SPCx2800	1	1003686	4014486477757

## MEGA 218 II

18	AT 4.5M - 5.1M	17x2690	1	1003866	4014486465327

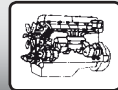

# GRIMME

	(B95.02293)	3	No AP	
	(B95.02294)	3	No AP	
	B95.02001	2	1004893	4014486713923
	B95.02004	4	1002832	4014486463149
	B95.02005	2	1002830	4014486463125
	B95.02006	1	1003406	4014486463286
	B95.02008	1	1004429	4014486715286
	B95.02009	1	1004435	4014486715347
	B95.02017	1	1004447	4014486715484
	B95.02025	1	1000501	4014486467765
	B95.02026	1	1004449	4014486715507
	B95.02033	1	1000511	4014486467895
	B95.02035	1	1004451	4014486715521
	B95.02044	1	1004739	4014486718966
	B95.02045	4	1002182	4014486477252
	B95.02047	1	1001358	4014486474725
	B95.02049	1	1004742	4014486720297
	B95.02070	1	1000348	4014486466027
	B95.02079	1	1000502	4014486467772
	B95.02090	1	1004461	4014486715637
	B95.02104	1	No AP	
	B95.02106	1	1002460	4014486493436
	B95.02111	4	1003023	4014486476859
	B95.02113	4	1004213	4014486675849
	B95.02114	4	1000274	4014486520187
	B95.02116	4	1002173	4014486477085
	B95.02117	2	1004430	4014486715293
	B95.02118	2	1004405	4014486714715
	B95.02120	1	1000675	4014486470475
	B95.02122	1	1000504	4014486467826
	B95.02124	1	1004453	4014486715545
	B95.02125	2	1002167	4014486476958
	B95.02126	2	1003019	4014486477474
	B95.02127	2	1004769	4014486716818
	B95.02128	3	1003020	4014486477313
	B95.02131	2	1000520	4014486468007
	B95.02134	2	1000508	4014486467864
	B95.02138	4	1004783	4014486716948
	B95.02142	2	1002833	4014486466034
	B95.02145	2	1003021	4014486476828
	B95.02146	2	1004774	4014486716856
	B95.02147	2	1004450	4014486715514
	B95.02149	4	1000250	4014486463866
	B95.02150	4	1002793	4014486464351
	B95.02151	4	No AP	
	B95.02152	4	1004302	4014486683004
	B95.02155	1	1000228	4014486463088
	B95.02158	4	1003762	4014486463682
	B95.02161	1	1003408	4014486463392
	B95.02162	5	1002764	4014486520002
	B95.02165	4	1002834	4014486463675
	B95.02166	1	1003413	4014486463569
	B95.02167	1	1003344	4014486463767
	B95.02169	1	1002595	4014486495980
	B95.02170	1	1002600	4014486496079



## GRIMME

	B95.02171	1	1000342	4014486465914
	B95.02188	4	1002154	4014486476736
	B95.02193	4	1002158	4014486476781
	B95.02205	4	1003024	4014486476422
	B95.02206	4	1004766	4014486716788
	B95.02207	1	1000589	4014486469158
	B95.02208	4	1003025	4014486476873
	B95.02209	1	1000588	4014486469110
	B95.02210	1	1000593	4014486469202
	B95.02211	4	1004770	4014486716825
	B95.02223	3	1002113	4014486476149
	B95.02224	4	1002125	4014486476293
	B95.02225	4	1002136	4014486476484
	B95.02226	3	1000761	4014486471625
	B95.02227	3	1000837	4014486472646
	B95.02228	3	1002837	4014486462753
	B95.02229	3	1002888	4014486471977
	B95.02232	4	1002129	4014486476347
	B95.02239	1	1002099	4014486475937
	B95.02240	1	1002095	4014486475883
	B95.02241	1	1000260	4014486464108
	B95.02244	1	1001349	4014486474626
	B95.02245	1	1001344	4014486474572
	B95.02246	1	1000626	4014486469752
	B95.02247	3	1000828	4014486472530
	B95.02250	4	1002765	4014486464344
	B95.02259	1	1003528	4014486470277
	B95.02260	2	1002889	4014486469912
	B95.02261	1	1000870	4014486473094
	B95.02262	1	1002325	4014486478532
	B95.02263	1	1002331	4014486478624
	B95.02265	2	1000768	4014486471755
	B95.02269	1	1000263	4014486464191
	B95.02271	1	1004555	4014486719918
	B95.02272	3	1004481	4014486715804
	B95.02273	3	1004462	4014486715644
	B95.02274	3	1004478	4014486715774
	B95.02280	1	1002601	4014486496086
	B95.02281	1	1000624	4014486520262
	B95.02288	1	1001354	4014486474688
	B95.02289	4	No AP	
	B95.02289	4	No AP	
	B95.02290	3	1004777	4014486716887
	B95.02292	4	1004767	4014486716795
	B95.02293	1	1003895	4014486489378
	B95.02294	1	1004587	4014486717792
	B95.02302	4	No AP	
	B95.02304	2	1004458	4014486715606
	B95.02306	6	1004763	4014486719260
	B95.02308	1	1000580	4014486468977
	B95.02309	1	1002588	4014486495812
	B95.02309	1	1002589	4014486495836
	B95.02314	4	1004757	4014486719208
	B95.02317	4	No AP	
	B95.02318	3	1004459	4014486715613



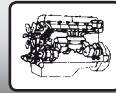

# GRIMME

	B95.02319	6	1004765	4014486716771
	B95.02322	1	No AP	
	B95.02325	3	1004479	4014486715781
	B95.02326	3	1004465	4014486715682
	B95.02327	3	1004480	4014486715798
	B95.02328	3	1004483	4014486715828
	B95.02329	3	1000828	4014486472530
	B95.02330	3	1004460	4014486715620
	B95.02331	1	1004557	4014486719932
	B95.02332	3	1004484	4014486715835
	B95.02333	1	1004858	4014486717679
	B95.02336	1	1004554	4014486719901
	B95.02337	1	1004553	4014486719895
	B95.02338	1	1004552	4014486719888
	B95.02339	1	1004474	4014486715736
	B95.02341	4	1004759	4014486719222
	B95.02342	2	1004768	4014486716801
	B95.02343	4	1004761	4014486719246
	B95.02348	4	1004756	4014486719192
	B95.05842	1	1004578	4014486717709
	B95.05854	1	No AP	
	B95.05856	3	1004762	4014486719253
	B95.05866	1	1004415	4014486715262
	B95.05873	4	1004732	4014486719024
	B95.05876	1	No AP	
	B95.05891	1	1004556	4014486719925
	B95.05902	2	1004094	4014486520019
	B95.05934	4	No AP	



## JOHN DEERE

330					
1	REEL DRIVE VARIABLE SPEED	Z20459	1	1003583	4014486459029
2	STRAW ELEVATOR DRIVE	Z20460	1	1000697	4014486470789
3	REEL DRIVE	Z20562	1	1000753	4014486471526
4	HYDRAULIC PUMP DRIVE	Z21171	1	1003371	4014486461190
4	HYDRAULIC PUMP DRIVE	Z21254	1	1003372	4014486461244
4	HYDRAULIC PUMP DRIVE	Z23752	1	1000095	4014486460933
5	UNLOADING SYSTEM	Z21398	1	1000561	4014486468601
5	UNLOADING SYSTEM	Z21400	1	1003496	4014486468649
6	THRESHING DRUM VARIATOR DRIVE	Z21401	1	No AP	
6	THRESHING DRUM VARIATOR DRIVE	Z21402	1	No AP	
7	SICKLE KNIFE DRIVE	Z23693	1	1000695	4014486470765
9	FAN DRIVE VARIABLE SPEED	Z20459	1	1003583	4014486459029
10	FAN DRIVE	Z20703	1	1000679	4014486470529
11	CYLINDER DRIVE	Z20823	1	1003587	4014486460230
12	ROTARY SCREEN - ELEVATOR	Z20743	1	1003505	4014486469196
430					
1	REEL DRIVE VARIABLE SPEED	Z20459	1	1003583	4014486459029
2	STRAW ELEVATOR DRIVE	Z20460	1	1000697	4014486470789
3	REEL DRIVE	Z20562	1	1000753	4014486471526
4	HYDRAULIC PUMP DRIVE	Z21171	1	1003371	4014486461190
4	HYDRAULIC PUMP DRIVE	Z21254	1	1003372	4014486461244
4	HYDRAULIC PUMP DRIVE	Z23752	1	1000095	4014486460933
5	UNLOADING SYSTEM	Z21398	1	1000561	4014486468601
5	UNLOADING SYSTEM	Z21400	1	1003496	4014486468649
6	THRESHING DRUM VARIATOR DRIVE	Z21401	1	No AP	
6	THRESHING DRUM VARIATOR DRIVE	Z21402	1	No AP	
7	SICKLE KNIFE DRIVE	Z23693	1	1000695	4014486470765
9	FAN DRIVE VARIABLE SPEED	Z20459	1	1003583	4014486459029
10	FAN DRIVE	Z20703	1	1000679	4014486470529
11	CYLINDER DRIVE	Z20823	1	1003587	4014486460230
12	ROTARY SCREEN - ELEVATOR	Z20743	1	1003505	4014486469196
530					
1	REEL DRIVE VARIABLE SPEED	Z20459	1	1003583	4014486459029
2	REEL DRIVE	Z20562	1	1000753	4014486471526
3	HYDRAULIC PUMP DRIVE	Z21171	1	1003371	4014486461190
3	HYDRAULIC PUMP DRIVE	Z21254	1	1003372	4014486461244
4	UNLOADING SYSTEM	Z21398	1	1000561	4014486468601
4	UNLOADING SYSTEM	Z21400	1	1003496	4014486468649
5	THRESHING DRUM VARIATOR DRIVE	Z21403	1	No AP	
6	SICKLE KNIFE DRIVE	Z21500	1	1001103	4014486496857
7	STRAW ELEVATOR DRIVE	Z21501	1	1001102	4014486496840
9	FAN DRIVE VARIABLE SPEED	Z20459	1	1003583	4014486459029
10	FAN DRIVE	Z20703	1	1000679	4014486470529
11	ROTARY SCREEN - ELEVATOR	Z20743	1	1003505	4014486469196
12	CYLINDER DRIVE	Z20823	1	1003587	4014486460230
13	HYDRAULIC PUMP DRIVE - ENGINE	Z22208	1	1003720	4014486494891
630					
1	REEL DRIVE VARIABLE SPEED	Z20459	1	1003583	4014486459029
2	REEL DRIVE	Z20562	1	1000753	4014486471526
3	HYDRAULIC PUMP DRIVE	Z21171	1	1003371	4014486461190



## JOHN DEERE

3	HYDRAULIC PUMP DRIVE	Z21254	1	1003372	4014486461244
4	UNLOADING SYSTEM	Z21398	1	1000561	4014486468601
4	UNLOADING SYSTEM	Z21400	1	1003496	4014486468649
5	THRESHING DRUM VARIATOR DRIVE	Z21403	1	No AP	
6	SICKLE KNIFE DRIVE	Z21500	1	1001103	4014486496857
7	STRAW ELEVATOR DRIVE	Z21501	1	1001102	4014486496840
9	FAN DRIVE VARIABLE SPEED	Z20459	1	1003583	4014486459029
10	FAN DRIVE	Z20703	1	1000679	4014486470529
11	ROTARY SCREEN - ELEVATOR	Z20743	1	1003505	4014486469196
12	CYLINDER DRIVE	Z20823	1	1003587	4014486460230
13	HYDRAULIC PUMP DRIVE - ENGINE	Z22208	1	1003720	4014486494891

### 730

1	REEL DRIVE VARIABLE SPEED	Z20459	1	1003583	4014486459029
2	REEL DRIVE	Z20562	1	1000753	4014486471526
3	HYDRAULIC PUMP DRIVE	Z21254	1	1003372	4014486461244
4	UNLOADING SYSTEM	Z21400	1	1003496	4014486468649
5	SICKLE KNIFE DRIVE	Z21500	1	1001103	4014486496857
5	SICKLE KNIFE DRIVE	Z21501	1	1001102	4014486496840
6	STRAW ELEVATOR DRIVE	Z21501	1	1001102	4014486496840
7	THRESHING DRUM VARIATOR DRIVE	Z22648	1	No AP	
9	FAN DRIVE VARIABLE SPEED	Z20459	1	1003583	4014486459029
10	FAN DRIVE	Z20703	1	1000679	4014486470529
11	ROTARY SCREEN - ELEVATOR	Z20743	1	1003505	4014486469196
12	CYLINDER DRIVE	Z20823	1	1003587	4014486460230
13	HYDRAULIC PUMP DRIVE - ENGINE	Z22208	1	1003720	4014486494891

### 930

1	REEL DRIVE	Z20562	1	1000753	4014486471526
2	REEL DRIVE VARIABLE SPEED	Z20459	1	1003583	4014486459029
2	REEL DRIVE VARIABLE SPEED	Z30692	1	1001407	4014486459142
3	SICKLE KNIFE DRIVE	Z23693	1	1000695	4014486470765
4	STRAW ELEVATOR DRIVE	Z21501	1	1001102	4014486496840
4	STRAW ELEVATOR DRIVE	Z30130	1	1001111	4014486496949
5	TRACTION VARIATOR DRIVE	Z31367	1	1001452	4014486459609
7	UNLOADING SYSTEM	Z21400	1	1003496	4014486468649
9	STRAW WALKER DRIVE	Z25473	1	1003494	4014486468540
10	PURIFY DRIVE	Z31283	1	1000038	4014486460759
11	FAN DRIVE	Z20703	1	1000679	4014486470529
12	FAN DRIVE VARIABLE SPEED	Z20459	1	1003583	4014486459029
13	CYLINDER VARIATOR DRIVE	Z20823	1	1003587	4014486460230
14	ROTARY SCREEN DRIVE	Z28458	1	1000594	4014486469233

### 940

1	REEL DRIVE	Z20562	1	1000753	4014486471526
2	REEL DRIVE VARIABLE SPEED	Z20459	1	1003583	4014486459029
2	REEL DRIVE VARIABLE SPEED	Z30692	1	1001407	4014486459142
3	SICKLE KNIFE DRIVE	Z23693	1	1000695	4014486470765
4	STRAW ELEVATOR DRIVE	Z21501	1	1001102	4014486496840
4	STRAW ELEVATOR DRIVE	Z30130	1	1001111	4014486496949
5	TRACTION VARIATOR DRIVE	Z31367	1	1001452	4014486459609
7	UNLOADING SYSTEM	Z21400	1	1003496	4014486468649
9	STRAW WALKER DRIVE	Z25473	1	1003494	4014486468540
10	PURIFY DRIVE	Z31283	1	1000038	4014486460759
11	FAN DRIVE	Z20703	1	1000679	4014486470529



## JOHN DEERE

12	FAN DRIVE VARIABLE SPEED	Z20459	1	1003583	4014486459029
13	CYLINDER VARIATOR DRIVE	Z20823	1	1003587	4014486460230
14	ROTARY SCREEN DRIVE	Z28458	1	1000594	4014486469233

### 950

1	REEL DRIVE	Z20562	1	1000753	4014486471526
2	REEL DRIVE VARIABLE SPEED	Z20459	1	1003583	4014486459029
2	REEL DRIVE VARIABLE SPEED	Z30692	1	1001407	4014486459142
3	SICKLE KNIFE DRIVE	Z30130	1	1001111	4014486496949
4	STRAW ELEVATOR DRIVE	Z21501	1	1001102	4014486496840
6	THRESHING DRUM VARIATOR DRIVE	Z21403	1	No AP	
6	THRESHING DRUM VARIATOR DRIVE	Z29962	1	1004146	4014486523270
6	THRESHING DRUM VARIATOR DRIVE	Z32173	1	1001979	4014486490961
7	UNLOADING SYSTEM	Z21400	1	1003496	4014486468649
10	PURIFY DRIVE	Z31283	1	1000038	4014486460759
11	FAN DRIVE	Z20703	1	1000679	4014486470529
12	FAN DRIVE VARIABLE SPEED	Z20459	1	1003583	4014486459029
13	CYLINDER VARIATOR DRIVE	Z20823	1	1003587	4014486460230
14	ROTARY SCREEN DRIVE	Z28458	1	1000594	4014486469233
16	STRAW WALKER DRIVE	Z25473	1	1003494	4014486468540
16	STRAW WALKER DRIVE	Z25473	1	1003494	4014486468540

### 952

1	REEL DRIVE	Z20562	1	1000753	4014486471526
2	REEL DRIVE VARIABLE SPEED	Z20459	1	1003583	4014486459029
2	REEL DRIVE VARIABLE SPEED	Z30692	1	1001407	4014486459142
3	SICKLE KNIFE DRIVE	Z30130	1	1001111	4014486496949
4	STRAW ELEVATOR DRIVE	Z21501	1	1001102	4014486496840
4	STRAW ELEVATOR DRIVE	Z32568	1	1004129	4014486523119
6	MAIN DRIVE	Z21403	1	No AP	
7	UNLOADING SYSTEM	Z21400	1	1003496	4014486468649
9	STRAW CHOPPER DRIVE	Z33774	1	1000401	4014486466645
11	PURIFY DRIVE	Z31283	1	1000038	4014486460759
12	FAN DRIVE	Z34405	1	1000675	4014486470475
13	FAN DRIVE VARIABLE SPEED	Z20459	1	1003583	4014486459029
14	CYLINDER VARIATOR DRIVE	Z20823	1	1003587	4014486460230
15	ROTARY SCREEN DRIVE	Z20743	1	1003505	4014486469196
15	WATERPUMP DRIVE	Z32190	1	1000002	4014486458985

### 955

1	REEL DRIVE	Z20562	1	1000753	4014486471526
2	REEL DRIVE VARIABLE SPEED	Z20459	1	1003583	4014486459029
2	REEL DRIVE VARIABLE SPEED	Z30692	1	1001407	4014486459142
3	SICKLE KNIFE DRIVE	Z30130	1	1001111	4014486496949
4	STRAW ELEVATOR DRIVE	Z21501	1	1001102	4014486496840
4	STRAW ELEVATOR DRIVE	Z32568	1	1004129	4014486523119
6	MAIN DRIVE	Z21403	1	No AP	
7	UNLOADING SYSTEM	Z21400	1	1003496	4014486468649
9	STRAW CHOPPER DRIVE	Z33774	1	1000401	4014486466645
10	PURIFY DRIVE	Z31283	1	1000038	4014486460759
10	STRAW WALKER DRIVE	Z32883	1	1000157	4014486461794
11	FAN DRIVE	Z34405	1	1000675	4014486470475
12	FAN DRIVE VARIABLE SPEED	Z20459	1	1003583	4014486459029
13	CYLINDER VARIATOR DRIVE	Z20823	1	1003587	4014486460230
15	ROTARY SCREEN DRIVE	Z20743	1	1003505	4014486469196

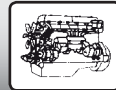

## JOHN DEERE

15	WATERPUMP DRIVE	Z32190	1	1000002	4014486458985
<b>960</b>					
1	REEL DRIVE	Z20562	1	1000753	4014486471526
2	REEL DRIVE VARIABLE SPEED	Z20459	1	1003583	4014486459029
2	REEL DRIVE VARIABLE SPEED	Z30692	1	1001407	4014486459142
3	SICKLE KNIFE DRIVE	Z30130	1	1001111	4014486496949
4	STRAW ELEVATOR DRIVE	Z21501	1	1001102	4014486496840
6	THRESHING DRUM VARIATOR DRIVE	Z21403	1	No AP	
6	THRESHING DRUM VARIATOR DRIVE	Z29962	1	1004146	4014486523270
6	THRESHING DRUM VARIATOR DRIVE	Z32173	1	1001979	4014486490961
7	UNLOADING SYSTEM	Z21400	1	1003496	4014486468649
10	PURIFY DRIVE	Z31283	1	1000038	4014486460759
11	FAN DRIVE	Z20703	1	1000679	4014486470529
12	FAN DRIVE VARIABLE SPEED	Z20459	1	1003583	4014486459029
13	CYLINDER VARIATOR DRIVE	Z20823	1	1003587	4014486460230
14	ROTARY SCREEN DRIVE	Z28458	1	1000594	4014486469233
16	STRAW WALKER DRIVE	Z25473	1	1003494	4014486468540
<b>965</b>					
1	REEL DRIVE	Z20562	1	1000753	4014486471526
2	REEL DRIVE VARIABLE SPEED	Z20459	1	1003583	4014486459029
3	MAIN DRIVE	Z33790	1	1001995	4014486491180
4	UNLOADING SYSTEM	Z33368	1	1000603	4014486469370
5	HYDRAULIC PUMP DRIVE	Z34828	1	1003397	4014486462821
6	TRACTION DRIVE	AZ22914	2	1002915	4014486496918
8	STRAW ELEVATOR DRIVE	Z21500	1	1001103	4014486496857
10	RADIATOR FAN DRIVE	Z24833	1	No AP	
11	PURIFY DRIVE	Z31283	1	1000038	4014486460759
12	COUNTERSHAFT - PURIFY DRIVE	Z32190	1	1000002	4014486458985
13	CYLINDER DRIVE	Z20823	1	1003587	4014486460230
14	FAN DRIVE	Z34405	1	1000675	4014486470475
15	SICKLE KNIFE DRIVE	Z30130	1	1001111	4014486496949
<b>970</b>					
1	REEL DRIVE	Z20562	1	1000753	4014486471526
2	REEL DRIVE VARIABLE SPEED	Z20459	1	1003583	4014486459029
2	REEL DRIVE VARIABLE SPEED	Z30692	1	1001407	4014486459142
3	SICKLE KNIFE DRIVE	Z30130	1	1001111	4014486496949
4	STRAW ELEVATOR DRIVE	Z21501	1	1001102	4014486496840
6	THRESHING DRUM VARIATOR DRIVE	Z21403	1	No AP	
6	THRESHING DRUM VARIATOR DRIVE	Z29962	1	1004146	4014486523270
6	THRESHING DRUM VARIATOR DRIVE	Z32173	1	1001979	4014486490961
7	UNLOADING SYSTEM	Z21400	1	1003496	4014486468649
10	PURIFY DRIVE	Z31283	1	1000038	4014486460759
11	FAN DRIVE	Z20703	1	1000679	4014486470529
12	FAN DRIVE VARIABLE SPEED	Z20459	1	1003583	4014486459029
13	CYLINDER VARIATOR DRIVE	Z20823	1	1003587	4014486460230
14	ROTARY SCREEN DRIVE	Z28458	1	1000594	4014486469233
16	STRAW WALKER DRIVE	Z25473	1	1003494	4014486468540
<b>975</b>					
1	REEL DRIVE	Z20562	1	1000753	4014486471526
2	REEL DRIVE VARIABLE SPEED	Z20459	1	1003583	4014486459029
3	MAIN DRIVE	Z33790	1	1001995	4014486491180

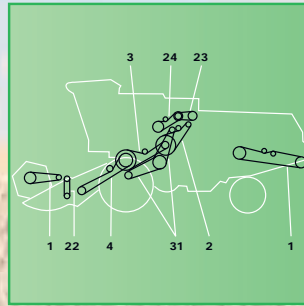
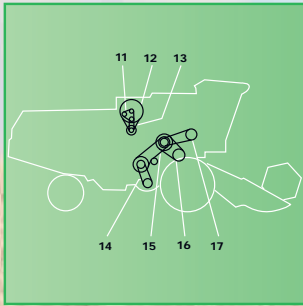

## JOHN DEERE

4	UNLOADING SYSTEM	Z33368	1	1000603	4014486469370
5	HYDRAULIC PUMP DRIVE	Z34828	1	1003397	4014486462821
6	TRACTION DRIVE	AZ22914	2	1002915	4014486496918
8	STRAW ELEVATOR DRIVE	Z21500	1	1001103	4014486496857
10	RADIATOR FAN DRIVE	Z24833	1	No AP	
11	PURIFY DRIVE	Z31283	1	1000038	4014486460759
12	COUNTERSHAFT - PURIFY DRIVE	Z32190	1	1000002	4014486458985
13	CYLINDER DRIVE	Z20823	1	1003587	4014486460230
14	FAN DRIVE	Z34405	1	1000675	4014486470475
15	SICKLE KNIFE DRIVE	Z30130	1	1001111	4014486496949

### 985

1	REEL DRIVE	Z20562	1	1000753	4014486471526
2	REEL DRIVE	Z30692	1	1001407	4014486459142
3	MAIN	Z33790	1	1001995	4014486491180
4	UNLOADING DRIVE	Z33368	1	1000603	4014486469370
5	HYDRAULIC PUMP DRIVE	Z34828	1	1003397	4014486462821
6	STRAW DISCHARGE	Z33605	1	1000162	4014486461848
7	HYDRAULIC PUMP DRIVE - ENGINE	CA20518	1	1003386	4014486462425
9	TRACTION (UPPER)	AZ22914	2	1002915	4014486496918
10	TRACTION (LOWER)	Z34099	1	1001523	4014486460421
11	MAIN DRIVE	Z38186	1	1001647	4014486485998
14	PURIFY DRIVE	Z37192	1	1004106	4014486522815
16	CYLINDER	Z37473	1	1003589	4014486460315
18	FAN DRIVE VARIABLE SPEED	Z20459	1	1003583	4014486459029

### 1032

1	STRAW WALKER DRIVE	Z33774	1	1000401	4014486466645
2		Z46222	1	1001861	4014486488975
3	LEAD-IN DRIVE	Z20460	1	1000697	4014486470789
3	LEAD-IN DRIVE	Z21501	1	1001102	4014486496840
3	LEAD-IN DRIVE	Z38186	1	1001647	4014486485998
4	CUTTING TABLE DRIVE	Z23693	1	1000695	4014486470765
4	CUTTING TABLE DRIVE	Z39313	1	1001109	4014486496925
12	ROTARY SCREEN DRIVE	Z31283	1	1000038	4014486460759
13	ROTARY SCREEN DRIVE	Z32190	1	1000002	4014486458985
14	FAN DRIVE VARIABLE SPEED	Z41178	1	1001396	4014486459012
15	FAN DRIVE VARIABLE SPEED	Z34405	1	1000675	4014486470475
16		Z53288	1	1001507	4014486460223
17	ELEVATOR DRIVE UNIT	Z20743	1	1003505	4014486469196
21		Z44740	1	1000747	4014486471441
22	REEL DRIVE VARIABLE SPEED	Z36813	1	1001397	4014486459036
23	HYDRAULIC PUMP DRIVE	Z42382	1	1002811	4014486462920
24	DISCHARGE BEATER DRIVE	Z43253	1	1003492	4014486468465
31	MAIN DRIVE	Z36120	1	1001438	4014486459463

### 1042

1	STRAW WALKER DRIVE	Z33774	1	1000401	4014486466645
2		Z46222	1	1001861	4014486488975
3	LEAD-IN DRIVE	Z20460	1	1000697	4014486470789
3	LEAD-IN DRIVE	Z21501	1	1001102	4014486496840
3	LEAD-IN DRIVE	Z38186	1	1001647	4014486485998
4	CUTTING TABLE DRIVE	Z23693	1	1000695	4014486470765
4	CUTTING TABLE DRIVE	Z39313	1	1001109	4014486496925
12	ROTARY SCREEN DRIVE	Z31283	1	1000038	4014486460759

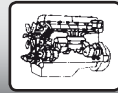
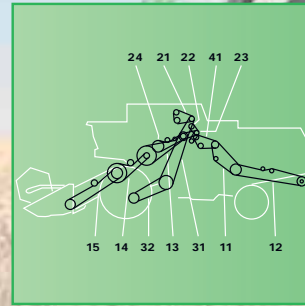
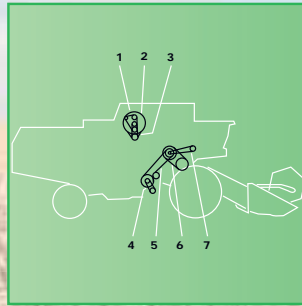
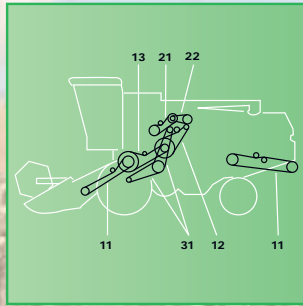
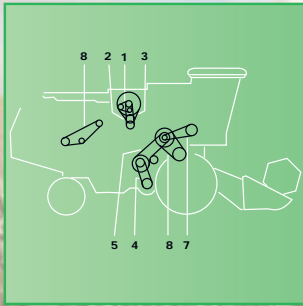

## JOHN DEERE

13	ROTARY SCREEN DRIVE	Z32190	1	1000002	4014486458985
14	FAN DRIVE VARIABLE SPEED	Z41178	1	1001396	4014486459012
15	FAN DRIVE VARIABLE SPEED	Z34405	1	1000675	4014486470475
16		Z53288	1	1001507	4014486460223
17	ELEVATOR DRIVE UNIT	Z20743	1	1003505	4014486469196
21		Z44740	1	1000747	4014486471441
22	REEL DRIVE VARIABLE SPEED	Z36813	1	1001397	4014486459036
23	HYDRAULIC PUMP DRIVE	Z42382	1	1002811	4014486462920
24	DISCHARGE BEATER DRIVE	Z43253	1	1003492	4014486468465
31	MAIN DRIVE	Z36120	1	1001438	4014486459463

### 1052

1	STRAW WALKER DRIVE	Z33774	1	1000401	4014486466645
2		Z46222	1	1001861	4014486488975
3	LEAD-IN DRIVE	Z20460	1	1000697	4014486470789
3	LEAD-IN DRIVE	Z21501	1	1001102	4014486496840
3	LEAD-IN DRIVE	Z38186	1	1001647	4014486485998
4	CUTTING TABLE DRIVE	Z23693	1	1000695	4014486470765
4	CUTTING TABLE DRIVE	Z39313	1	1001109	4014486496925
12	ROTARY SCREEN DRIVE	Z31283	1	1000038	4014486460759
13	ROTARY SCREEN DRIVE	Z32190	1	1000002	4014486458985
14	FAN DRIVE VARIABLE SPEED	Z41178	1	1001396	4014486459012
15	FAN DRIVE VARIABLE SPEED	Z34405	1	1000675	4014486470475
16		Z53288	1	1001507	4014486460223
17	ELEVATOR DRIVE UNIT	Z20743	1	1003505	4014486469196
21		Z44740	1	1000747	4014486471441
22	REEL DRIVE VARIABLE SPEED	Z36813	1	1001397	4014486459036
23	HYDRAULIC PUMP DRIVE	Z42382	1	1002811	4014486462920
24	DISCHARGE BEATER DRIVE	Z43253	1	1003492	4014486468465
31	MAIN DRIVE	Z36120	1	1001438	4014486459463

### 1055

2	ROTARY SCREEN DRIVE	Z31283	1	1000038	4014486460759
3	ROTARY SCREEN DRIVE	Z32190	1	1000002	4014486458985
4	FAN DRIVE VARIABLE SPEED	Z41178	1	1001396	4014486459012
5	FAN DRIVE VARIABLE SPEED	Z34405	1	1000675	4014486470475
6		Z53288	1	1001507	4014486460223
7	ELEVATOR DRIVE UNIT	Z20743	1	1003505	4014486469196
8		Z35965	1	1000153	4014486461756
11	STRAW WALKER DRIVE	Z33774	1	1000401	4014486466645
12		Z21403	1	No AP	
12		Z46222	1	1001861	4014486488975
13	LEAD-IN DRIVE	Z21501	1	1001102	4014486496840
13	LEAD-IN DRIVE	Z38186	1	1001647	4014486485998
14	CUTTING TABLE DRIVE	Z39312	1	1001118	4014486497038
14	CUTTING TABLE DRIVE	Z39313	1	1001109	4014486496925
21	DISCHARGE BEATER DRIVE	Z43253	1	1003492	4014486468465
22	HYDRAULIC PUMP DRIVE	Z42382	1	1002811	4014486462920

### 1065

1	FAN DRIVE	AR72036	1	1002351	4014486478846
2	ROTARY SCREEN DRIVE	Z31283	1	1000038	4014486460759
3	ROTARY SCREEN DRIVE	Z32190	1	1000002	4014486458985
4	FAN DRIVE VARIABLE SPEED	Z41178	1	1001396	4014486459012
5	FAN DRIVE VARIABLE SPEED	Z34405	1	1000675	4014486470475

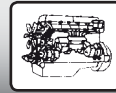
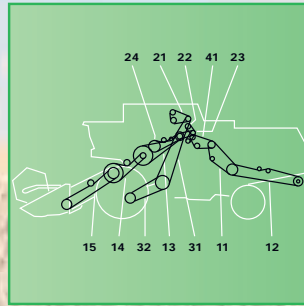
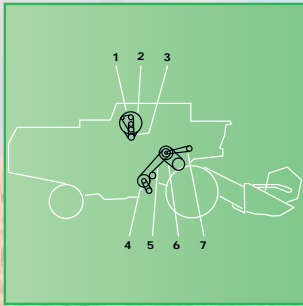

## JOHN DEERE

6	MAIN DRIVE	Z34099	1	1001523	4014486460421
7	LEAD-IN DRIVE	Z21501	1	1001102	4014486496840
8	LEAD-IN DRIVE	Z32568	1	1004129	4014486523119
9	CUTTING TABLE DRIVE	Z39313	1	1001109	4014486496925
10	CUTTING TABLE DRIVE	Z39314	1	1001121	4014486497076
11	SHAKER SHAFT DRIVE	Z35965	1	1000153	4014486461756
12	CYLINDER VARIATOR DRIVE	Z20823	1	1003587	4014486460230
13	CUTTING TABLE DRIVE LEAD-IN	Z33790	1	1001995	4014486491180
18	REEL DRIVE VARIABLE SPEED	Z36813	1	1001397	4014486459036
19	REEL DRIVE VARIABLE SPEED	Z20562	1	1000753	4014486471526
20	MAIN DRIVE	AZ22914	2	1002915	4014486496918
21	STRAW WALKER DRIVE	Z33774	1	1000401	4014486466645
21	AIR CONDITIONING COMPRESSOR DRIVE SUB. FOR Z41889	Z42756	1	1002350	4014486478839
23	HYDROSTATIC PUMP DRIVE	Z34828	1	1003397	4014486462821
	AIR CONDITIONING COMPRESSOR DRIVE	CA22534	1	1000228	4014486463088
	DISCHARGE BEATER DRIVE	Z43253	1	1003492	4014486468465

### 1068

1	FAN DRIVE	AR72036	1	1002351	4014486478846
2	ROTARY SCREEN DRIVE	Z34786	1	1000040	4014486460773
3	ROTARY SCREEN DRIVE	Z32190	1	1000002	4014486458985
4	FAN DRIVE VARIABLE SPEED	Z41178	1	1001396	4014486459012
5	FAN DRIVE VARIABLE SPEED	Z34405	1	1000675	4014486470475
6	CYLINDER VARIATOR DRIVE	Z53288	1	1001507	4014486460223
7		Z45026	1	1000261	4014486464177
11	SHAKER SHAFT DRIVE	Z35965	1	1000153	4014486461756
12	CYLINDER VARIATOR DRIVE	Z20823	1	1003587	4014486460230
12	STRAW WALKER DRIVE	Z33774	1	1000401	4014486466645
13	CUTTING TABLE DRIVE LEAD-IN	Z33790	1	1001995	4014486491180
14	LEAD-IN DRIVE (GRAIN)	Z21501	1	1001102	4014486496840
14	LEAD-IN DRIVE (MAIZE)	Z38186	1	1001647	4014486485998
15	CUTTING TABLE DRIVE	Z39312	1	1001118	4014486497038
15	CUTTING TABLE DRIVE	Z39313	1	1001109	4014486496925
15	CUTTING TABLE DRIVE	Z39314	1	1001121	4014486497076
21	AIR CONDITIONING COMPRESSOR DRIVE SUB. FOR Z41889	Z42756	1	1002350	4014486478839
22	AIR CONDITIONING COMPRESSOR DRIVE (FROM NR. 33563)	Z45482	1	1003400	4014486462906
23	HYDRAULIC PUMP DRIVE	Z34828	1	1003397	4014486462821
24		Z47911	1	1000604	4014486469363
32	MAIN DRIVE	Z34099	1	1001523	4014486460421
41		Z43863	1	1000036	4014486460735

### 1072

1	REEL DRIVE VARIABLE SPEED	Z33790	1	1001995	4014486491180
3	AIR CONDITIONING COMPRESSOR DRIVE	CA22534	1	1000228	4014486463088
4	HYDROSTATIC PUMP DRIVE	Z34828	1	1003397	4014486462821
5	SHAKER SHAFT DRIVE	Z35965	1	1000153	4014486461756
6	MAIN DRIVE	Z21501	1	1001102	4014486496840
8	CUTTING TABLE DRIVE	Z39313	1	1001109	4014486496925
10	ROTARY SCREEN DRIVE	Z31283	1	1000038	4014486460759
11	ROTARY SCREEN DRIVE	Z32190	1	1000002	4014486458985
12	CYLINDER VARIATOR DRIVE	Z20823	1	1003587	4014486460230
13	FAN DRIVE VARIABLE SPEED	Z34405	1	1000675	4014486470475
16	REEL DRIVE VARIABLE SPEED	Z36813	1	1001397	4014486459036
17	REEL DRIVE VARIABLE SPEED	Z20562	1	1000753	4014486471526
22	STRAW WALKER DRIVE	Z33774	1	1000401	4014486466645



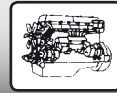
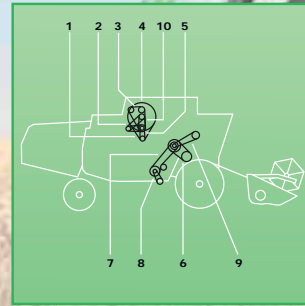
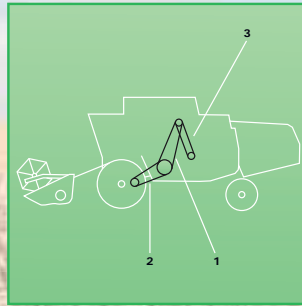
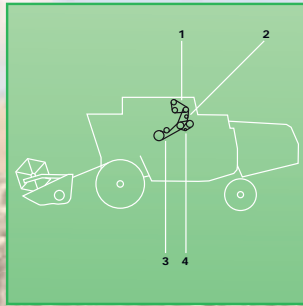
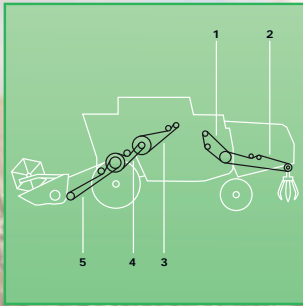

# JOHN DEERE

23	MAIN DRIVE	Z33967	1	1001497	4014486460100
<b>1075</b>					
1	CUTTING TABLE DRIVE LEAD-IN	Z33790	1	1001995	4014486491180
2	DISCHARGE BEATER DRIVE	Z33368	1	1000603	4014486469370
4	HYDROSTATIC PUMP DRIVE	Z34828	1	1003397	4014486462821
5	SHAKER SHAFT DRIVE	Z35965	1	1000153	4014486461756
6	MAIN DRIVE	Z34099	1	1001523	4014486460421
7	LEAD-IN DRIVE	Z21501	1	1001102	4014486496840
7	LEAD-IN DRIVE	Z38186	1	1001647	4014486485998
8	CUTTING TABLE DRIVE	Z39314	1	1001121	4014486497076
9	FAN DRIVE	AR72036	1	1002351	4014486478846
12	ROTARY SCREEN DRIVE	Z34786	1	1000040	4014486460773
13	ROTARY SCREEN DRIVE	Z32190	1	1000002	4014486458985
14	CYLINDER VARIATOR DRIVE	Z37473	1	1003589	4014486460315
15	FAN DRIVE VARIABLE SPEED	Z34405	1	1000675	4014486470475
16	FAN DRIVE VARIABLE SPEED	Z41178	1	1001396	4014486459012
18	REEL DRIVE VARIABLE SPEED	Z36813	1	1001397	4014486459036
19	REEL DRIVE VARIABLE SPEED	Z20562	1	1000753	4014486471526
20	MAIN DRIVE	AZ22914	2	1002915	4014486496918
21	STRAW WALKER DRIVE	Z33774	1	1000401	4014486466645
<b>1085</b>					
1	CUTTING TABLE DRIVE LEAD-IN	Z38697	1	1001996	4014486491203
2	DISCHARGE BEATER DRIVE	Z33368	1	1000603	4014486469370
3	AIR CONDITIONING COMPRESSOR DRIVE	Z41932	1	1000229	4014486463118
4	HYDROSTATIC PUMP DRIVE	Z34828	1	1003397	4014486462821
5	SHAKER SHAFT DRIVE	Z35965	1	1000153	4014486461756
6	MAIN DRIVE	Z34099	1	1001523	4014486460421
7	LEAD-IN DRIVE	Z38186	1	1001647	4014486485998
10	ROTARY SCREEN DRIVE	Z38704	1	1000039	4014486460766
12	CYLINDER VARIATOR DRIVE	Z37473	1	1003589	4014486460315
13	FAN DRIVE VARIABLE SPEED	Z34405	1	1000675	4014486470475
14	FAN DRIVE VARIABLE SPEED	Z41178	1	1001396	4014486459012
16	REEL DRIVE VARIABLE SPEED	Z36813	1	1001397	4014486459036
17	REEL DRIVE VARIABLE SPEED	Z20562	1	1000753	4014486471526
19	MAIN DRIVE	AZ22914	2	1002915	4014486496918
22	STRAW WALKER DRIVE	Z33774	1	1000401	4014486466645
<b>1088</b>					
1		Z51212	1	1001027	4014486487800
3		Z34828	1	1003397	4014486462821
4		Z42757	1	1003343	4014486462975
5		Z33774	1	1000401	4014486466645
7		Z43889	1	1002707	4014486486452
9		Z46709	1	1001832	4014486488555
10		Z43890	1	1003643	4014486489156
11		Z46463	1	1001261	4014486492200
12		Z46365	1	1001404	4014486459104
13		Z44936	1	1001542	4014486460612
15		Z42756	1	1002350	4014486478839
16		Z43863	1	1000036	4014486460735
17		Z38704	1	1000039	4014486460766

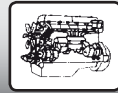
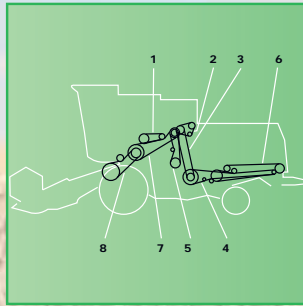
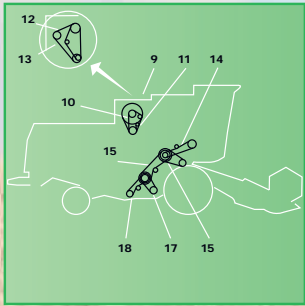

## JOHN DEERE

1155					
1	FAN DRIVE	AR72036	1	1002351	4014486478846
2		Z31283	1	1000038	4014486460759
2		Z38704	1	1000039	4014486460766
4		Z20459	1	1003583	4014486459029
5		Z34405	1	1000675	4014486470475
6		Z53288	1	1001507	4014486460223
7		Z20743	1	1003505	4014486469196
8		Z35965	1	1000153	4014486461756
11		Z33774	1	1000401	4014486466645
12		Z46222	1	1001861	4014486488975
13		Z21501	1	1001102	4014486496840
14		Z39312	1	1001118	4014486497038
14		Z39313	1	1001109	4014486496925
21		Z43253	1	1003492	4014486468465
22		Z42382	1	1002811	4014486462920
1157					
1	FAN DRIVE	AR72036	1	1002351	4014486478846
2		Z31283	1	1000038	4014486460759
2		Z38704	1	1000039	4014486460766
4		Z20459	1	1003583	4014486459029
5		Z34405	1	1000675	4014486470475
6		Z53288	1	1001507	4014486460223
7		Z20743	1	1003505	4014486469196
8		Z35965	1	1000153	4014486461756
11		Z33774	1	1000401	4014486466645
12		Z46222	1	1001861	4014486488975
13		Z21501	1	1001102	4014486496840
14		Z39312	1	1001118	4014486497038
14		Z39313	1	1001109	4014486496925
21		Z43253	1	1003492	4014486468465
22		Z42382	1	1002811	4014486462920
1158					
1	FAN DRIVE	AR72036	1	1002351	4014486478846
2		Z31283	1	1000038	4014486460759
2		Z38704	1	1000039	4014486460766
4		Z20459	1	1003583	4014486459029
5		Z34405	1	1000675	4014486470475
6		Z53288	1	1001507	4014486460223
7		Z20743	1	1003505	4014486469196
8		Z35965	1	1000153	4014486461756
11		Z33774	1	1000401	4014486466645
12		Z46222	1	1001861	4014486488975
13		Z21501	1	1001102	4014486496840
14		Z39312	1	1001118	4014486497038
14		Z39313	1	1001109	4014486496925
21		Z43253	1	1003492	4014486468465
22		Z42382	1	1002811	4014486462920
1170					
5		Z46709	1	1001832	4014486488555
7		Z46463	1	1001261	4014486492200

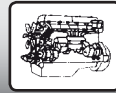
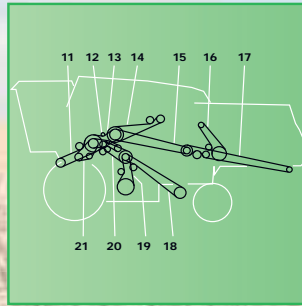
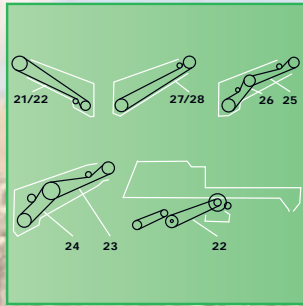
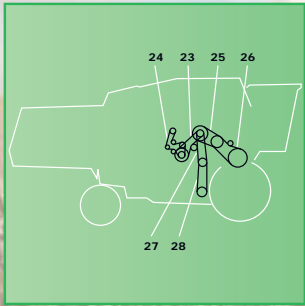

## JOHN DEERE

8		Z43890	1	1003643	4014486489156
13		R123451	1	1003150	4014486481099
14		Z45026	1	1000261	4014486464177
16		Z44936	1	1001542	4014486460612
17		Z41178	1	1001396	4014486459012
19		Z46709	1	1001832	4014486488555
<b>2054</b>					
1		Z54406	1	1001122	4014486497083
1		Z55801	1	1000786	4014486472028
1		Z61151	1	1001761	4014486487442
2		Z58752	1	1000788	4014486472042
2		Z59419	1	1001125	4014486497113
3		Z59556	1	1000635	4014486469899
3		Z63005	1	1000648	4014486470093
4		Z59557	1	1001388	4014486475043
5		Z44936	1	1001542	4014486460612
6		Z53515	1	1001973	4014486490886
6		Z61858	1	1001973	4014486490886
7		Z62110	1	1001423	4014486459302
8		Z62111	1	1001432	4014486459401
11		Z59344	1	1003858	4014486519907
13		Z52909	1	1003856	4014486496680
13		Z61150	1	1001754	4014486519532
13		Z63327	1	1001751	4014486519525
13		Z64912	1	1001751	4014486519525
14		Z61857	1	1001190	4014486520422
15		Z59286	1	1001911	4014486489736
16		Z59114	1	1000324	4014486465488
17		Z59342	1	1003622	4014486487114
18		Z60135	1	1000395	4014486466584
19		Z59322	1	1000640	4014486469981
20		Z56959	1	1001089	4014486496710
21		Z56421	1	1001084	4014486496666
22		Z48212	1	1001769	4014486519600
23		Z60931	1	1003623	4014486487503
23		Z61152	1	1001764	4014486487473
24		Z61154	1	1001448	4014486459562
24		Z62211	1	1001449	4014486459579
25		Z54807	1	1001096	4014486496789
25		Z58751	1	1004084	4014486520453
25		Z60931	1	1003623	4014486487503
25		Z61152	1	1001764	4014486487473
26		Z55459	1	1001085	4014486496673
26		Z61153	1	1001753	4014486487367
26		Z61827	1	1001755	4014486519549
26		Z62213	1	1003856	4014486496680
27		Z54406	1	1001122	4014486497083
27		Z62214	1	1001127	4014486497137
27		Z62551	1	1001784	4014486519655
28		Z60930	1	1001784	4014486519655
28		Z62552	1	1001786	4014486519679
<b>2056</b>					
1		Z54406	1	1001122	4014486497083

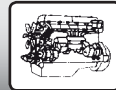
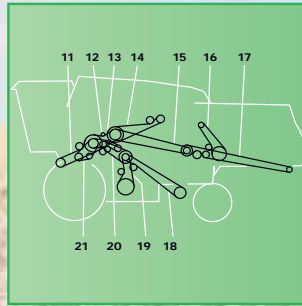
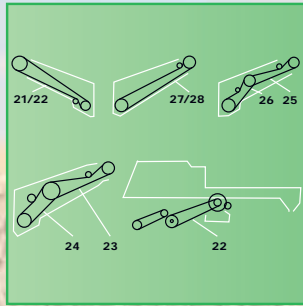
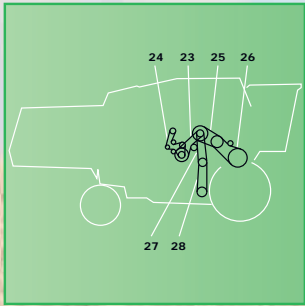

## JOHN DEERE

1		Z55801	1	1000786	4014486472028
1		Z61151	1	1001761	4014486487442
2		Z58752	1	1000788	4014486472042
2		Z59419	1	1001125	4014486497113
3		Z59556	1	1000635	4014486469899
3		Z63005	1	1000648	4014486470093
4		Z59557	1	1001388	4014486475043
5		Z44936	1	1001542	4014486460612
6		Z61858	1	1001973	4014486490886
7		Z62110	1	1001423	4014486459302
8		Z62111	1	1001432	4014486459401
11		Z59344	1	1003858	4014486519907
13		Z52909	1	1003856	4014486496680
13		Z61150	1	1001754	4014486519532
13		Z64912	1	1001751	4014486519525
14		Z61857	1	1001190	4014486520422
15		Z59286	1	1001911	4014486489736
16		Z59114	1	1000324	4014486465488
17		Z59342	1	1003622	4014486487114
18		Z60135	1	1000395	4014486466584
19		Z59322	1	1000640	4014486469981
20		Z56959	1	1001089	4014486496710
21		Z56421	1	1001084	4014486496666
22		Z48212	1	1001769	4014486519600
23		Z60931	1	1003623	4014486487503
23		Z61152	1	1001764	4014486487473
24		Z61154	1	1001448	4014486459562
24		Z62211	1	1001449	4014486459579
25		Z54807	1	1001096	4014486496789
25		Z58751	1	1004084	4014486520453
25		Z60931	1	1003623	4014486487503
25		Z61152	1	1001764	4014486487473
26		Z55459	1	1001085	4014486496673
26		Z61153	1	1001753	4014486487367
26		Z61827	1	1001755	4014486519549
26		Z62213	1	1003856	4014486496680
27		Z54406	1	1001122	4014486497083
27		Z62214	1	1001127	4014486497137
27		Z62551	1	1001784	4014486519655
28		Z60930	1	1001784	4014486519655
28		Z62552	1	1001786	4014486519679

### 2058

1		Z54406	1	1001122	4014486497083
1		Z55801	1	1000786	4014486472028
1		Z61151	1	1001761	4014486487442
2		Z58752	1	1000788	4014486472042
2		Z59419	1	1001125	4014486497113
3		Z59556	1	1000635	4014486469899
3		Z63005	1	1000648	4014486470093
4		Z59557	1	1001388	4014486475043
5		Z44936	1	1001542	4014486460612
6		Z61858	1	1001973	4014486490886
7		Z62110	1	1001423	4014486459302
8		Z62111	1	1001432	4014486459401

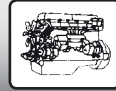
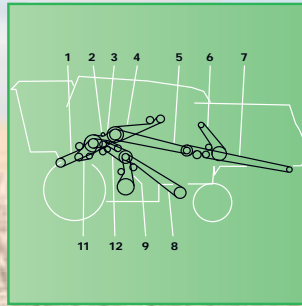
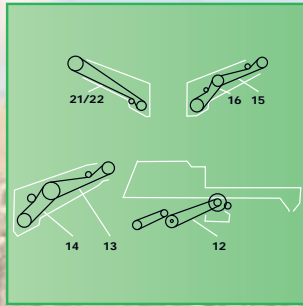
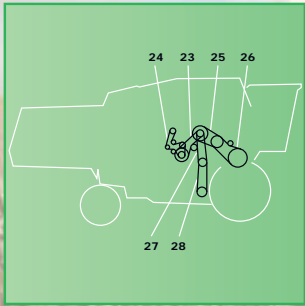

## JOHN DEERE

11		Z59344	1	1003858	4014486519907
13		Z52909	1	1003856	4014486496680
13		Z61150	1	1001754	4014486519532
13		Z64912	1	1001751	4014486519525
14		Z61857	1	1001190	4014486520422
15		Z59286	1	1001911	4014486489736
16		Z59114	1	1000324	4014486465488
17		Z59342	1	1003622	4014486487114
18		Z60135	1	1000395	4014486466584
19		Z59322	1	1000640	4014486469981
20		Z56959	1	1001089	4014486496710
21		Z56421	1	1001084	4014486496666
22		Z48212	1	1001769	4014486519600
23		Z60931	1	1003623	4014486487503
23		Z61152	1	1001764	4014486487473
24		Z61154	1	1001448	4014486459562
24		Z62211	1	1001449	4014486459579
25		Z54807	1	1001096	4014486496789
25		Z58751	1	1004084	4014486520453
25		Z60931	1	1003623	4014486487503
25		Z61152	1	1001764	4014486487473
26		Z55459	1	1001085	4014486496673
26		Z61153	1	1001753	4014486487367
26		Z61827	1	1001755	4014486519549
26		Z62213	1	1003856	4014486496680
27		Z54406	1	1001122	4014486497083
27		Z62214	1	1001127	4014486497137
27		Z62551	1	1001784	4014486519655
28		Z60930	1	1001784	4014486519655
28		Z62552	1	1001786	4014486519679

## 2064

1		Z59344	1	1003858	4014486519907
1		Z61151	1	1001761	4014486487442
3		Z52909	1	1003856	4014486496680
3		Z61150	1	1001754	4014486519532
3		Z64912	1	1001751	4014486519525
4		Z61857	1	1001190	4014486520422
5		Z59286	1	1001911	4014486489736
6		Z59114	1	1000324	4014486465488
7		Z59342	1	1003622	4014486487114
8		Z60135	1	1000395	4014486466584
9		Z56421	1	1001084	4014486496666
10		Z56959	1	1001089	4014486496710
11		Z59322	1	1000640	4014486469981
12		Z48212	1	1001769	4014486519600
12		Z59419	1	1001125	4014486497113
13		Z60931	1	1003623	4014486487503
13		Z61152	1	1001764	4014486487473
14		Z61154	1	1001448	4014486459562
14		Z62211	1	1001449	4014486459579
15		Z54807	1	1001096	4014486496789
15		Z58751	1	1004084	4014486520453
15		Z60931	1	1003623	4014486487503
15		Z61152	1	1001764	4014486487473

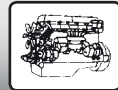
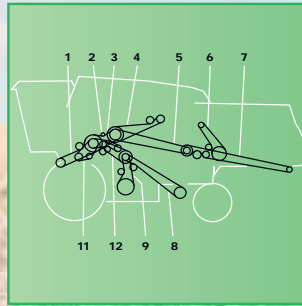
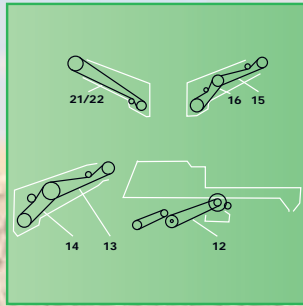
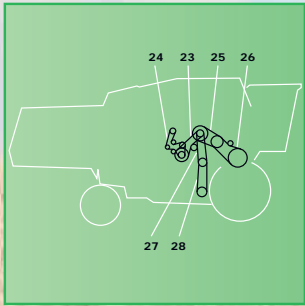

## JOHN DEERE

16		Z55459	1	1001085	4014486496673
16		Z61153	1	1001753	4014486487367
16		Z61827	1	1001755	4014486519549
16		Z62213	1	1003856	4014486496680
21		Z54406	1	1001122	4014486497083
21		Z55801	1	1000786	4014486472028
22		Z58752	1	1000788	4014486472042
22		Z59419	1	1001125	4014486497113
23		Z59556	1	1000635	4014486469899
23		Z63005	1	1000648	4014486470093
24		Z59557	1	1001388	4014486475043
25		Z44936	1	1001542	4014486460612
26		Z61858	1	1001973	4014486490886
27		Z62110	1	1001423	4014486459302
28		Z62111	1	1001432	4014486459401
<b>2066</b>					
1		Z59344	1	1003858	4014486519907
1		Z61151	1	1001761	4014486487442
3		Z52909	1	1003856	4014486496680
3		Z61150	1	1001754	4014486519532
3		Z64912	1	1001751	4014486519525
4		Z61857	1	1001190	4014486520422
5		Z59286	1	1001911	4014486489736
6		Z59114	1	1000324	4014486465488
7		Z59342	1	1003622	4014486487114
8		Z60135	1	1000395	4014486466584
9		Z56421	1	1001084	4014486496666
10		Z56959	1	1001089	4014486496710
11		Z59322	1	1000640	4014486469981
12		Z48212	1	1001769	4014486519600
12		Z59419	1	1001125	4014486497113
13		Z60931	1	1003623	4014486487503
13		Z61152	1	1001764	4014486487473
14		Z61154	1	1001448	4014486459562
14		Z62211	1	1001449	4014486459579
15		Z54807	1	1001096	4014486496789
15		Z58751	1	1004084	4014486520453
15		Z60931	1	1003623	4014486487503
15		Z61152	1	1001764	4014486487473
16		Z55459	1	1001085	4014486496673
16		Z61153	1	1001753	4014486487367
16		Z61827	1	1001755	4014486519549
16		Z62213	1	1003856	4014486496680
21		Z54406	1	1001122	4014486497083
21		Z55801	1	1000786	4014486472028
22		Z58752	1	1000788	4014486472042
22		Z59419	1	1001125	4014486497113
23		Z59556	1	1000635	4014486469899
23		Z63005	1	1000648	4014486470093
24		Z59557	1	1001388	4014486475043
25		Z44936	1	1001542	4014486460612
26		Z61858	1	1001973	4014486490886
27		Z62110	1	1001423	4014486459302
28		Z62111	1	1001432	4014486459401

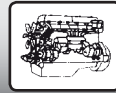
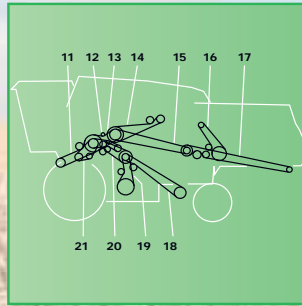
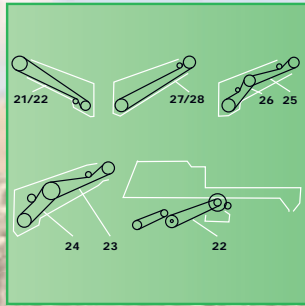
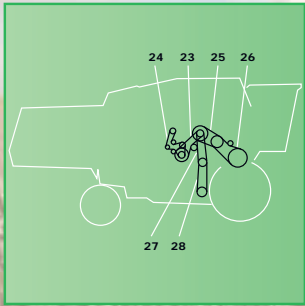

# JOHN DEERE

2250					
4	PLATFORM DRIVE	E58967	1	1004189	4014486558135
2254					
1		Z59344	1	1003858	4014486519907
1		Z61151	1	1001761	4014486487442
3		Z61150	1	1001754	4014486519532
3		Z64912	1	1001751	4014486519525
4		Z61857	1	1001190	4014486520422
5		Z59286	1	1001911	4014486489736
6		Z59114	1	1000324	4014486465488
7		Z59342	1	1003622	4014486487114
8		Z60135	1	1000395	4014486466584
9		Z59322	1	1000640	4014486469981
10		Z56959	1	1001089	4014486496710
11		Z56421	1	1001084	4014486496666
12		Z48212	1	1001769	4014486519600
13		Z60931	1	1003623	4014486487503
13		Z61152	1	1001764	4014486487473
14		Z62211	1	1001449	4014486459579
15		Z54807	1	1001096	4014486496789
15		Z58751	1	1004084	4014486520453
15		Z60931	1	1003623	4014486487503
15		Z61152	1	1001764	4014486487473
16		Z61827	1	1001755	4014486519549
16		Z62213	1	1003856	4014486496680
17		Z54406	1	1001122	4014486497083
17		Z62551	1	1001784	4014486519655
18		Z62214	1	1001127	4014486497137
18		Z62552	1	1001786	4014486519679
21		Z54406	1	1001122	4014486497083
22		Z59419	1	1001125	4014486497113
23		Z63005	1	1000648	4014486470093
24		Z59557	1	1001388	4014486475043
25		Z44936	1	1001542	4014486460612
26		Z61858	1	1001973	4014486490886
27		Z62110	1	1001423	4014486459302
28		Z62111	1	1001432	4014486459401
2256					
1		Z59344	1	1003858	4014486519907
1		Z61151	1	1001761	4014486487442
3		Z61150	1	1001754	4014486519532
3		Z64912	1	1001751	4014486519525
4		Z61857	1	1001190	4014486520422
5		Z59286	1	1001911	4014486489736
6		Z59114	1	1000324	4014486465488
7		Z59342	1	1003622	4014486487114
8		Z60135	1	1000395	4014486466584
9		Z59322	1	1000640	4014486469981
10		Z56959	1	1001089	4014486496710
11		Z56421	1	1001084	4014486496666
12		Z48212	1	1001769	4014486519600
13		Z60931	1	1003623	4014486487503

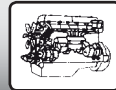
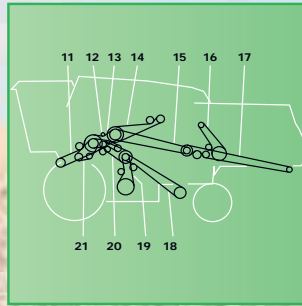
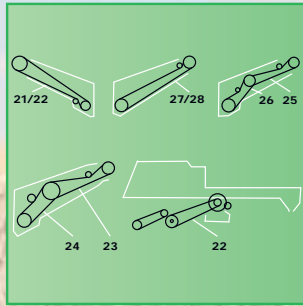
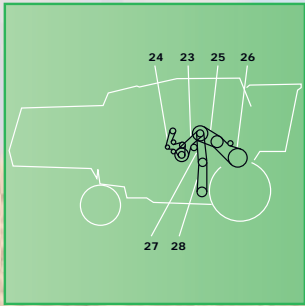

## JOHN DEERE

13		Z61152	1	1001764	4014486487473
14		Z62211	1	1001449	4014486459579
15		Z54807	1	1001096	4014486496789
15		Z58751	1	1004084	4014486520453
15		Z60931	1	1003623	4014486487503
15		Z61152	1	1001764	4014486487473
16		Z61827	1	1001755	4014486519549
16		Z62213	1	1003856	4014486496680
17		Z54406	1	1001122	4014486497083
17		Z62551	1	1001784	4014486519655
18		Z62214	1	1001127	4014486497137
18		Z62552	1	1001786	4014486519679
21		Z54406	1	1001122	4014486497083
22		Z59419	1	1001125	4014486497113
23		Z63005	1	1000648	4014486470093
24		Z59557	1	1001388	4014486475043
25		Z44936	1	1001542	4014486460612
26		Z61858	1	1001973	4014486490886
27		Z62110	1	1001423	4014486459302
28		Z62111	1	1001432	4014486459401

## 2258

1		Z59344	1	1003858	4014486519907
1		Z61151	1	1001761	4014486487442
3		Z61150	1	1001754	4014486519532
3		Z64912	1	1001751	4014486519525
4		Z61857	1	1001190	4014486520422
5		Z59286	1	1001911	4014486489736
6		Z59114	1	1000324	4014486465488
7		Z59342	1	1003622	4014486487114
8		Z60135	1	1000395	4014486466584
9		Z59322	1	1000640	4014486469981
10		Z56959	1	1001089	4014486496710
11		Z56421	1	1001084	4014486496666
12		Z48212	1	1001769	4014486519600
13		Z60931	1	1003623	4014486487503
13		Z61152	1	1001764	4014486487473
14		Z62211	1	1001449	4014486459579
15		Z54807	1	1001096	4014486496789
15		Z58751	1	1004084	4014486520453
15		Z60931	1	1003623	4014486487503
15		Z61152	1	1001764	4014486487473
16		Z61827	1	1001755	4014486519549
16		Z62213	1	1003856	4014486496680
17		Z54406	1	1001122	4014486497083
17		Z62551	1	1001784	4014486519655
18		Z62214	1	1001127	4014486497137
18		Z62552	1	1001786	4014486519679
21		Z54406	1	1001122	4014486497083
22		Z59419	1	1001125	4014486497113
23		Z63005	1	1000648	4014486470093
24		Z59557	1	1001388	4014486475043
25		Z44936	1	1001542	4014486460612
26		Z61858	1	1001973	4014486490886
27		Z62110	1	1001423	4014486459302



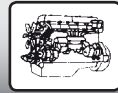
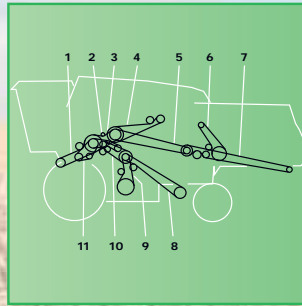
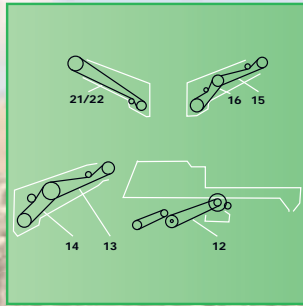
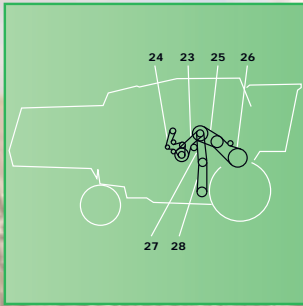

## JOHN DEERE

28		Z62111	1	1001432	4014486459401
<b>2264</b>					
1		Z59344	1	1003858	4014486519907
1		Z61151	1	1001761	4014486487442
3		Z61150	1	1001754	4014486519532
3		Z64912	1	1001751	4014486519525
4		Z61857	1	1001190	4014486520422
5		Z59286	1	1001911	4014486489736
6		Z59114	1	1000324	4014486465488
7		Z59342	1	1003622	4014486487114
8		Z60135	1	1000395	4014486466584
9		Z56421	1	1001084	4014486496666
10		Z56959	1	1001089	4014486496710
11		Z59322	1	1000640	4014486469981
12		Z48212	1	1001769	4014486519600
13		Z60931	1	1003623	4014486487503
13		Z61152	1	1001764	4014486487473
14		Z62211	1	1001449	4014486459579
15		Z54807	1	1001096	4014486496789
15		Z58751	1	1004084	4014486520453
15		Z60931	1	1003623	4014486487503
15		Z61152	1	1001764	4014486487473
16		Z61827	1	1001755	4014486519549
16		Z62213	1	1003856	4014486496680
21		Z54406	1	1001122	4014486497083
22		Z59419	1	1001125	4014486497113
23		Z63005	1	1000648	4014486470093
24		Z59557	1	1001388	4014486475043
25		Z44936	1	1001542	4014486460612
26		Z61858	1	1001973	4014486490886
27		Z62110	1	1001423	4014486459302
28		Z62111	1	1001432	4014486459401
<b>2266</b>					
1		Z59344	1	1003858	4014486519907
1		Z61151	1	1001761	4014486487442
3		Z61150	1	1001754	4014486519532
3		Z64912	1	1001751	4014486519525
4		Z61857	1	1001190	4014486520422
5		Z59286	1	1001911	4014486489736
6		Z59114	1	1000324	4014486465488
7		Z59342	1	1003622	4014486487114
8		Z60135	1	1000395	4014486466584
9		Z56421	1	1001084	4014486496666
10		Z56959	1	1001089	4014486496710
11		Z59322	1	1000640	4014486469981
12		Z48212	1	1001769	4014486519600
13		Z60931	1	1003623	4014486487503
13		Z61152	1	1001764	4014486487473
14		Z62211	1	1001449	4014486459579
15		Z54807	1	1001096	4014486496789
15		Z58751	1	1004084	4014486520453
15		Z60931	1	1003623	4014486487503
15		Z61152	1	1001764	4014486487473

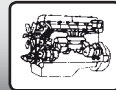
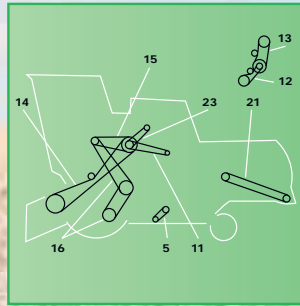
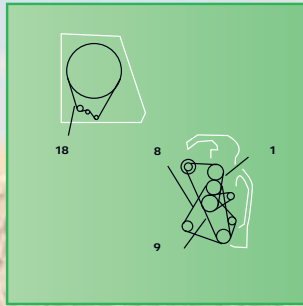
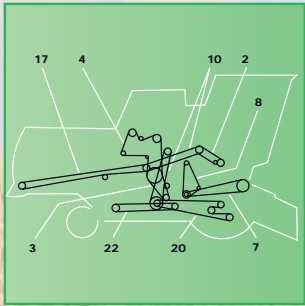

## JOHN DEERE

16		Z61827	1	1001755	4014486519549
16		Z62213	1	1003856	4014486496680
21		Z54406	1	1001122	4014486497083
22		Z59419	1	1001125	4014486497113
23		Z63005	1	1000648	4014486470093
24		Z59557	1	1001388	4014486475043
25		Z44936	1	1001542	4014486460612
26		Z61858	1	1001973	4014486490886
27		Z62110	1	1001423	4014486459302
28		Z62111	1	1001432	4014486459401
<b>2270</b>					
4	PLATFORM DRIVE	E58967	1	1004189	4014486558135
<b>2280</b>					
4	PLATFORM DRIVE	E58967	1	1004189	4014486558135
<b>3300</b>					
1	ALTERNATOR AND WATERPUMP DRIVE 329DH-02	H80896	1	1002570	4014486495355
7	AIR CONDITIONING COMPRESSOR DRIVE 292	H80896	1	1002570	4014486495355
7	COMPRESSOR DRIVE (GAS ENGINE) AC 292	H80896	1	1002570	4014486495355
7	AIR CONDITIONING COMPRESSOR DRIVE	H81742	1	No AP	
8	COMPRESSOR DRIVE (DIESEL ENGINE) AC 292	H80896	1	1002570	4014486495355
10	CYLINDER VARIATOR DRIVE	340435138	1	1004295	4014486683318
19	PROPULSION DRIVE (LOWER)	H76136	1	1000542	4014486468243
23	ROTARY SCREEN DRIVE	H86259	1	No AP	
24	COUNTERSHAFT (SECONDARY)	H138762	1	1000710	4014486470987
28	UNLOADING AUGER COUNTERSHAFT	H76136	1	1000542	4014486468243
<b>3400</b>					
1	ALTERNATOR AND WATERPUMP DRIVE 329DH-02	H80896	1	1002570	4014486495355
7	COMPRESSOR DRIVE (GAS ENGINE) AC 292	H80896	1	1002570	4014486495355
8	COMPRESSOR DRIVE (DIESEL ENGINE) AC 292	H80896	1	1002570	4014486495355
19	PROPULSION DRIVE (LOWER)	H76136	1	1000542	4014486468243
23	ROTARY SCREEN DRIVE	H86259	1	No AP	
24	COUNTERSHAFT (SECONDARY)	H138762	1	1000710	4014486470987
28	UNLOADING AUGER COUNTERSHAFT	H76136	1	1000542	4014486468243
<b>3430</b>					
3	WATERPUMP DRIVE	R73784	1	1003983	4014486519273
<b>3830</b>					
3	ROTARY SCREEN DRIVE	H86259	1	No AP	
<b>4400</b>					
1	ALTERNATOR AND WATERPUMP DRIVE 329DH-02	H80896	1	1002570	4014486495355
7	COMPRESSOR DRIVE (GAS ENGINE) AC 292	H80896	1	1002570	4014486495355
8	COMPRESSOR DRIVE (DIESEL ENGINE) AC 292	H80896	1	1002570	4014486495355
19	PROPULSION DRIVE (LOWER)	H76136	1	1000542	4014486468243
23	COUNTERSHAFT (SECONDARY)	H138762	1	1000710	4014486470987
23	ROTARY SCREEN DRIVE	H86259	1	No AP	
28	UNLOADING AUGER COUNTERSHAFT	H76136	1	1000542	4014486468243
<b>4420</b>					
5	ROTARY SCREEN DRIVE	H86259	1	No AP	

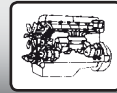
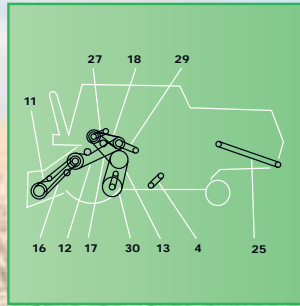
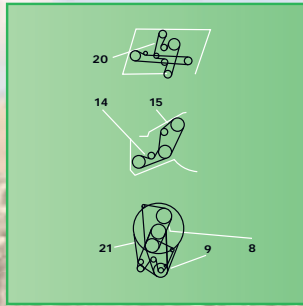
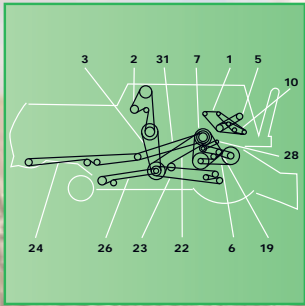

## JOHN DEERE

8	UNLOADING AUGER COUNTERSHAFT	H76136	1	1000542	4014486468243
14	STRAW SPREADER DRIVE	Z33774	1	1000401	4014486466645
15	BEATER DRIVE	Z33790	1	1001995	4014486491180
16	FEEDER HOUSE DRIVE	Z38186	1	1001647	4014486485998
17	STRAW CHOPPER (FRONT)	Z44761	1	1001668	4014486486315
24	COUNTERSHAFT (SECONDARY)	H138762	1	1000710	4014486470987
<b>4425</b>					
1	ALTERNATOR, WATER PUMP	AR72036	1	1002351	4014486478846
2	BEATER	Z33790	1	1001995	4014486491180
3	CLEANING FAN	Z41178	1	1001396	4014486459012
4	COMPRESSOR	Z42756	1	1002350	4014486478839
5	CONDENSER FAN	Z45482	1	1003400	4014486462906
6	CONDENSER ROTARY BLADE	Z43863	1	1000036	4014486460735
7	CONDENSER ROTARY BLADE	Z38704	1	1000039	4014486460766
8	COUNTERSHAFT TO ROTARY SCREEN	Z34786	1	1000040	4014486460773
9	CRANKSHAFT TO COUNTERSHAFT	Z32190	1	1000002	4014486458985
10	CYLINDER	Z65924	1	No AP	
11	FEEDER HOUSE	Z38186	1	1001647	4014486485998
12	LOWER GROUND DRIVE	Z34099	1	1001523	4014486460421
13	MAIN HYDRAULIC PUMP	Z34828	1	1003397	4014486462821
14	SEPARATOR	Z34405	1	1000675	4014486470475
15	STRAW CHOPPER, FRONT	Z44761	1	1001668	4014486486315
17	STRAW SPREADER	Z33774	1	1000401	4014486466645
18	TAILINGS ELEVATOR	Z45026	1	1000261	4014486464177
19	UNLOADING AUGER	Z47911	1	1000604	4014486469363
20	UPPER GROUND DRIVE (PKG. 2)	AZ35635	2	1001105	4014486496871
<b>4700</b>					
1		R500173	1	1003213	4014486482348
<b>6600</b>					
2	U-JOINT LOADING AUGER	H23950	1	1000682	4014486470581
3	CLEAN GRAIN ELEVATOR COUNTERSHAFT	H27433	1	1000598	4014486469301
5	AIR CONDITIONING COMPRESSOR DRIVE	H80896	1	1002570	4014486495355
7	CYLINDER - INTERMEDIATE SHAFT	H113749	1	1001514	4014486460339
11	FEEDER CONVEYOR (LONG FEEDER HOUSE)	H125380	1	1000791	4014486472073
13	HYDROSTATIC PROPULSION DRIVE (LOWER)	AH84633	2	1001087	4014486496697
17	HYDROSTATIC PROPULSION DRIVE (UPPER)	AH84633	2	1001087	4014486496697
21	ROTARY SCREEN DRIVE	H86259	1	No AP	
26	TAILINGS AUGER (LOWER)	N110085	1	1000702	4014486470857
31	STRAW CHOPPER DRIVE	H80103	1	1000709	4014486470970
<b>6602</b>					
8	ELEVATOR DRIVE GRAIN	H23950	1	1000682	4014486470581
17		H80103	1	1000709	4014486470970
18	ELEVATOR DRIVE GRAIN	H27433	1	1000598	4014486469301
19	AUGER DRIVE	N110085	1	1000702	4014486470857
<b>6610</b>					
1		Z48567	1	1002618	4014486498028
2		AZ39678	2	1002843	4014486464085
3		AZ39676	2	1002766	4014486464306
4		AZ39677	3	1001343	4014486474558

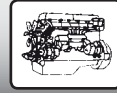
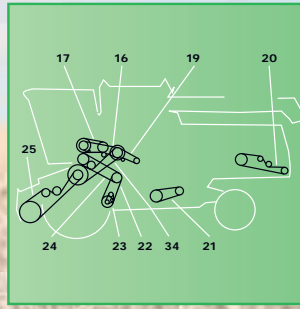
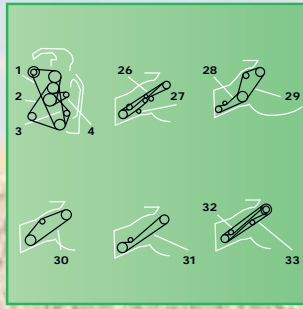
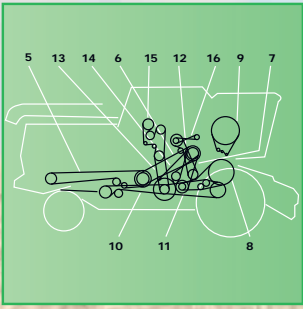

## JOHN DEERE

### 6620

9	ROTARY SCREEN DRIVE	H86259	1	No AP	
13	CLEAN GRAIN ELEVATOR COUNTERSHAFT	H27433	1	1000598	4014486469301
18	MULTI-GROOVE SEPARATOR DRIVE	H108175	1	1001140	4014486490022
22	GROUND DRIVE (LOWER)	AH84633	2	1001087	4014486496697
24	GROUND DRIVE (UPPER)	AH84633	2	1001087	4014486496697
25	FEEDER HOUSE DRIVE (REGULAR) (SERIAL NR. 502551-615100)	H111519	1	1004270	4014486683295
26	FEEDER CONVEYOR DRIVE (SERIAL NR. ... - 403301)	H125380	1	1000791	4014486472073
31	FEEDER HOUSE - LOWER FIXED LESS REVERSER (SERIAL NR 615100 - ...)	Z30130	1	1001111	4014486496949
	TORQUE-SENSING COUNTERSHAFT DRIVE	H113749	1	1001514	4014486460339

### 6622

5	LEFT-HAND SIDE	H136881	1	1000693	4014486470741
7	TORQUE-SENSING COUNTERSHAFT DRIVE	H113749	1	1001514	4014486460339
9	CLEAN GRAIN ELEVATOR AND LOADING	H23950	1	1000682	4014486470581
10	CLEAN GRAIN ELEVATOR COUNTERSHAFT	H27433	1	1000598	4014486469301
12		H27433	1	1000598	4014486469301
25	MULTI-GROOVE SEPARATOR DRIVE	H108175	1	1001140	4014486490022

### 6650

1		R136235	1	1002684	4014486482591
---	--	---------	---	---------	---------------

### 6700

1		R135199	1	1003235	4014486482669
---	--	---------	---	---------	---------------

### 6710

2		Z55771	1	1002360	4014486478945
---	--	--------	---	---------	---------------

### 6750

1		R503312	1	1002614	4014486484182
2		R502599	1	1002651	4014486481143

### 6810

1		AZ51312	2	1003982	4014486519808
2		Z58886	1	1003711	4014486494662
3		AZ56225	2	1002313	4014486480016

### 6950

1		AZ51638	1	1004153	4014486523676
---	--	---------	---	---------	---------------

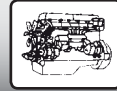
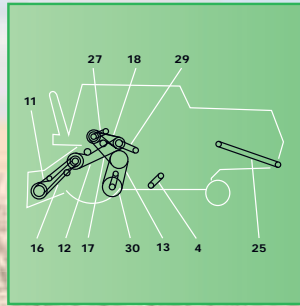
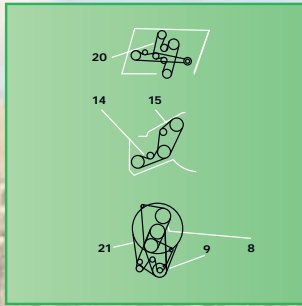
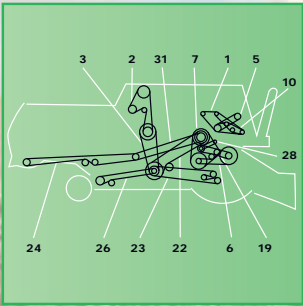

# JOHN DEERE

7700

1	ALTERNATOR AND WATERPUMP DRIVE (GAS ENGINE)	H80896	1	1002570	4014486495355
2	CLEAN GRAIN ELEVATOR U-JOINT LOADING AUGER	H23950	1	1000682	4014486470581
3	CLEAN GRAIN ELEVATOR COUNTERSHAFT	H27433	1	1000598	4014486469301
5	AIR CONDITIONING COMPRESSOR DRIVE 404TH-01	H80896	1	1002570	4014486495355
7	CYLINDER - INTERMEDIATE SHAFT	H113749	1	1001514	4014486460339
11	FEEDER CONVEYOR (LONG FEEDER HOUSE)	H125380	1	1000791	4014486472073
13	HYDROSTATIC PROPULSION DRIVE (LOWER)	AH84633	2	1001087	4014486496697
17	HYDROSTATIC PROPULSION DRIVE (UPPER)	AH84633	2	1001087	4014486496697
18	COUNTERSHAFT (PRIMARY) 404TH-01	H108175	1	1001140	4014486490022
21	ROTARY SCREEN DRIVE	H86259	1	No AP	
26	TAILINGS AUGER (LOWER)	N110085	1	1000702	4014486470857
31	STRAW CHOPPER DRIVE	H80103	1	1000709	4014486470970

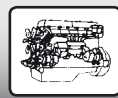
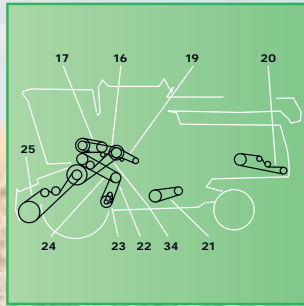
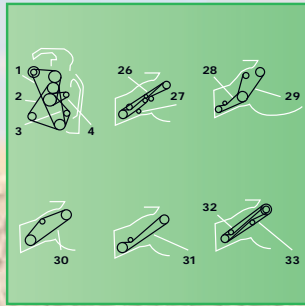
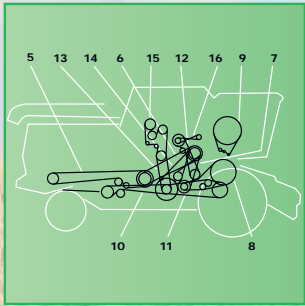

# JOHN DEERE

## 7720

5	ROTARY SCREEN DRIVE	H86259	1	No AP	
10	TORQUE-SENSING COUNTERSHAFT DRIVE	H113749	1	1001514	4014486460339
13	CLEAN GRAIN ELEVATOR COUNTERSHAFT	H27433	1	1000598	4014486469301
19	FEEDER CONVEYOR DRIVE	H125380	1	1000791	4014486472073
26	FEEDER HOUSE - LOWER (REGULAR)	H111519	1	1004270	4014486683295
27	MULTI-GROOVE SEPARATOR DRIVE	H108175	1	1001140	4014486490022
29	DRIVE (LOWER)	Z30130	1	1001111	4014486496949
36	GROUND DRIVE (UPPER)	AH84633	2	1001087	4014486496697
38	GROUND DRIVE (LOWER)	AH84633	2	1001087	4014486496697

## 7721

4	CLEAN GRAIN ELEVATOR COUNTERSHAFT	H27433	1	1000598	4014486469301
14	UNLOADING AUGER COUNTERSHAFT	H23950	1	1000682	4014486470581

## 7722

5	GROUND DRIVE (UPPER)	AH84633	2	1001087	4014486496697
9	ENGINE POWERSHAFT	AH84633	2	1001087	4014486496697
10	ENGINE POWERSHAFT	H108175	1	1001140	4014486490022
12	FEEDER HOUSE (LOWER)	H111519	1	1004270	4014486683295
15	CUTTERBAR DRIVE (HILLSIDE)	H21925	1	1000694	4014486470734



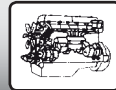
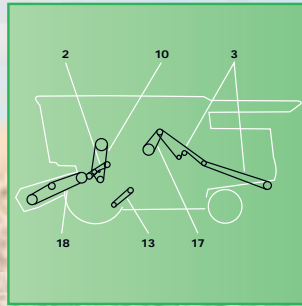
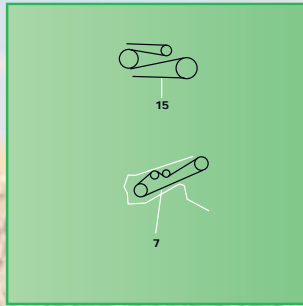
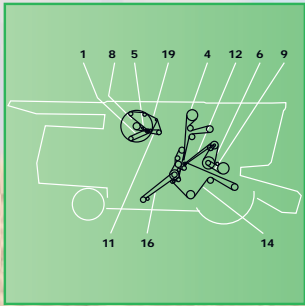

## JOHN DEERE

### 9400

2	ROTARY SCREEN DRIVE	H143869	1	No AP	
3	ROTARY SCREEN DRIVE	H134216	1	No AP	
6	CYLINDER DRIVE INTERMEDIATE	H115759	1	1001543	4014486460636
6	CLEAN GRAIN ELEVATOR DRIVE	H141167	1	1004088	4014486520088
7	CYLINDER DRIVE REGULAR DUAL RANGE	H115881	1	1003663	4014486490817
8	TAILINGS AUGER AND ELEVATOR (LOWER)	N110085	1	1000702	4014486470857
10	COUNTERSHAFT (SECONDARY)	H128010	1	1000797	4014486472165
11	STRAW WALKER SHOE - CONVEYOR AUGERS	H131169	1	1001392	4014486475104
12	UNLOADING SYSTEM	AH127866	2	1003765	4014486469394
13	STRAW CHOPPER DRIVE, FRONT	H125380	1	1000791	4014486472073
14	REGULAR	H140404	1	1001434	4014486459425
15	HEADER AND REEL PUMP	H125565	1	No AP	
15	HEADER AND REEL PUMP	H140160	1	1003570	4014486497014
16	FEEDER DRIVE VARIABLE SPEED	H125711	1	No AP	
17	BEATER (100 PERCENT BEATER SPEED)	AH139436	2	1001382	4014486474978
18	FEEDER HOUSE FIXED SPEED WITH REVERSER	H126345	1	1001124	4014486497106
19	STRAW SPREADER DRIVE	Z33774	1	1000401	4014486466645

### 9410

1	AIR CONDITIONING COMPRESSOR	H80896	1	1002570	4014486495355
3	ALTERNATOR, ENGINE	H101813	1	1002580	4014486495591
4	BEATER DRIVE (75 PERCENT)	AH163931	2	1001381	4014486474961
5	BEATER DRIVE (100 PERCENT)	AH139436	2	1001382	4014486474978
6	CHOPPER IN WINDROW OR FORWARD POSITION	H27433	1	1000598	4014486469301
10	COOLING FAN HIGH POWER	H132808	1	No AP	
11	CYLINDER DR. REGULAR DUAL RANGE & SINGLE RANGE	H115881	1	1003663	4014486490817
12	CYLINDER INTERMEDIATE DRIVE BELT	H210476	1	1001543	4014486460636
13	ENGINE FAN	H132808	1	No AP	
14	FEEDER HOUSE VARIABLE SPEED	H161648	1	No AP	
15	FIXED SPEED FEEDER HOUSE WITH REVERSER	H126345	1	1001124	4014486497106
18	HEADER AND REEL PUMP	H151952	1	1003570	4014486497014
19	LOWER TAILINGS AUGER & ELEVATOR	N110085	1	1000702	4014486470857
20	ROTARY SCREEN	H145158	1	No AP	
21	ROTARY SCREEN DRIVE	H146636	1	1004193	4014486558487
22	SECONDARY COUNTERSHAFT	H128010	1	1000797	4014486472165
23	SHOE, STRAW WALKER & CONVEYOR AUGERS	H131169	1	1001392	4014486475104
24	STRAW CHOPPER DRIVE, FRONT	H125380	1	1000791	4014486472073
25	STRAW CHOPPER DRIVE, REGULAR	H140404	1	1001434	4014486459425
27	STRAW SPREADER	Z33774	1	1000401	4014486466645
28	UNLOADING SYSTEM	AH158880	2	1002861	4014486469400

### 9450

1	AIR CONDITIONING COMPRESSOR	H101813	1	1002580	4014486495591
3	ALTERNATOR (95 AMP)	H163515	1	1003209	4014486482256
4	ALTERNATOR (185 AMP)	H166870	1	1004090	4014486520521
5	BEATER DRIVE (75%)	AH163931	2	1001381	4014486474961
6	BEATER DRIVE (100%)	AH139436	2	1001382	4014486474978
7	CLEAN GRAIN ELEVATOR	H141166	1	1001394	4014486475128
8	CLEANING FAN (750 - 1350 RPM)	H152146	1	1001435	4014486459432
9	CLEANING FAN (490 - 980 RPM)	H152180	1	1001431	4014486459395
10	COOLING FAN	H132808	1	No AP	
11	COUNTERSHAFT SECONDARY	H128010	1	1000797	4014486472165
12	CYLINDER DRIVE (240 - 960 RPM) (STANDARD)	H115881	1	1003663	4014486490817



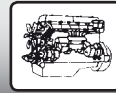
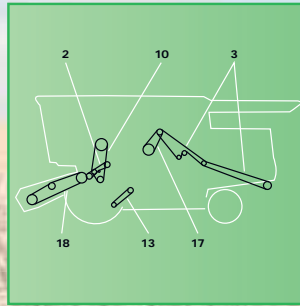
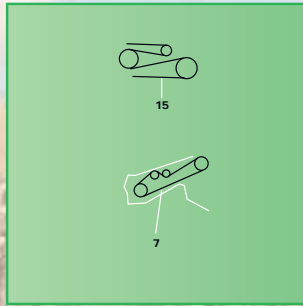
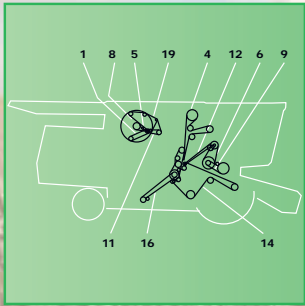

## JOHN DEERE

14	CYLINDER INTERMEDIATE DRIVE BELT	H210476	1	1001543	4014486460636
17	FEEDER HOUSE VARIABLE SPEED (-700100)	H161648	1	No AP	
19	FIXED SPEED FEEDER HOUSE W/REVERSER (-700100)	H126345	1	1001124	4014486497106
20	FIXED SPEED FEEDER HOUSE W/REVERSER (700101-)	H156796	1	1004269	4014486683301
21	HEADER AND REEL PUMP	H151952	1	1003570	4014486497014
22	LOWER TAILINGS AUGER & ELEVATOR	N110085	1	1000702	4014486470857
23	ROTARY SCREEN (-695100)	H145158	1	No AP	
24	ROTARY SCREEN (695101-)	H175632	1	1004469	4014486712117
25	ROTARY SCREEN DRIVE	H146636	1	1004193	4014486558487
26	SHOE, STRAW WALKER & CONVEYOR AUGERS	H131169	1	1001392	4014486475104
29	STRAW CHOPPER (SHORT REAR)	H27433	1	1000598	4014486469301
30	STRAW SPREADER	Z33774	1	1000401	4014486466645
31	UNLOADING SYSTEM	AH158880	2	1002861	4014486469400

### 9500

1	COOLING FAN	H132808	1	No AP	
2	ROTARY SCREEN DRIVE	H143869	1	No AP	
3	ROTARY SCREEN DRIVE	H134216	1	No AP	
4	AIR CONDITIONING COMPRESSOR DRIVE	H134437	1	No AP	
5	CLEAN GRAIN ELEVATOR DRIVE	H141167	1	1004088	4014486520088
6	CYLINDER DRIVE INTERMEDIATE	H115759	1	1001543	4014486460636
7	CYLINDER DRIVE REGULAR DUAL RANGE	H115881	1	1003663	4014486490817
8	TAILINGS AUGER AND ELEVATOR (LOWER)	N110085	1	1000702	4014486470857
9	FOR ALTERNATOR	H134344	1	No AP	
10	COUNTERSHAFT (SECONDARY)	H128010	1	1000797	4014486472165
11	STRAW WALKER SHOE - CONVEYOR AUGERS	H131169	1	1001392	4014486475104
12	UNLOADING SYSTEM	AH127866	2	1003765	4014486469394
13	(FRONT)	H125380	1	1000791	4014486472073
13	LONG REAR	H125381	1	1000778	4014486471885
14	REGULAR	H140404	1	1001434	4014486459425
15	HEADER AND REEL PUMP	H125565	1	No AP	
15	HEADER AND REEL PUMP	H140160	1	1003570	4014486497014
16	FEEDER DRIVE VARIABLE SPEED	H125711	1	No AP	
17	BEATER (100 PERCENT BEATER SPEED)	AH139436	2	1001382	4014486474978
18	FEEDER HOUSE FIXED SPEED WITH REVERSER	H126345	1	1001124	4014486497106
19	STRAW SPREADER DRIVE	H128234	1	1000419	4014486466829

### 9501

1	BELT, FEED HOUSE DRIVE TIGHTENER	H151952	1	1003570	4014486497014
3	CYLINDER DR. REGULAR DUAL RANGE & SINGLE RANGE	H115881	1	1003663	4014486490817
4	CYLINDER INTERMEDIATE DRIVE BELT	H210476	1	1001543	4014486460636
5	FIXED SPEED FEEDER HOUSE WITH REVERSER	H126345	1	1001124	4014486497106
6	LOWER TAILINGS AUGER & ELEVATOR	N110085	1	1000702	4014486470857
8	REGULAR (100 PERCENT)	AH139436	2	1001382	4014486474978
8	SECONDARY COUNTERSHAFT	H128010	1	1000797	4014486472165
9	STRAW CHOPPER DRIVE, FRONT	H125380	1	1000791	4014486472073
9	SHOE, STRAW WALKER & CONVEYOR AUGERS	H131169	1	1001392	4014486475104
10	STRAW CHOPPER DRIVE, LONG REAR	H125381	1	1000778	4014486471885
11	STRAW CHOPPER DRIVE, REGULAR	H140404	1	1001434	4014486459425
14	STRAW SPREADER	H128234	1	1000419	4014486466829
16	UNLOADING SYSTEM	AH158880	2	1002861	4014486469400



## JOHN DEERE

### 9510

1	AIR CONDITIONING COMPRESSOR	H80896	1	1002570	4014486495355
3	ALTERNATOR, ENGINE	H101813	1	1002580	4014486495591
4	BEATER DRIVE (100 PERCENT)	AH139436	2	1001382	4014486474978
4	BEATER DRIVE (75 PERCENT)	AH163931	2	1001381	4014486474961
5	CHOPPER IN REAR (OPERATING) POSITION	H125381	1	1000778	4014486471885
5	CHOPPER IN WINDROW OR FORWARD POSITION	H23950	1	1000682	4014486470581
7	COOLING FAN LOW POWER	H132808	1	No AP	
8	CYLINDER DR. REGULAR DUAL RANGE & SINGLE RANGE	H115881	1	1003663	4014486490817
8	CYLINDER INTERMEDIATE DRIVE BELT	H210476	1	1001543	4014486460636
10	FEEDER HOUSE VARIABLE SPEED	H161648	1	No AP	
11	FIXED SPEED FEEDER HOUSE WITH REVERSER	H126345	1	1001124	4014486497106
12	LOWER TAILINGS AUGER & ELEVATOR	N110085	1	1000702	4014486470857
13	POWERSHAFT AND REEL PUMP	H151952	1	1003570	4014486497014
14	ROTARY SCREEN	H145158	1	No AP	
14	ROTARY SCREEN DRIVE	H146636	1	1004193	4014486558487
15	SECONDARY COUNTERSHAFT	H128010	1	1000797	4014486472165
16	SHOE, STRAW WALKER & CONVEYOR AUGERS	H131169	1	1001392	4014486475104
17	STRAW CHOPPER DRIVE, FRONT	H125380	1	1000791	4014486472073
17	STRAW CHOPPER DRIVE, REGULAR (750 - 1350 RPM)	H140404	1	1001434	4014486459425
18	STRAW SPREADER	H128234	1	1000419	4014486466829
19	UNLOADING SYSTEM	AH158880	2	1002861	4014486469400

### 9540

1		H175632	1	1004469	4014486712117
2		H115881	1	1003663	4014486490817
3		H177263	1	1001394	4014486475128
4		N110085	1	1000702	4014486470857
6	9540	H177589	1	1002285	4014486479683
7	9540	H175467	1	1003125	4014486480788
8		H176765	1	1001789	4014486519686
10		H177177	1	1001905	4014486489668
11		H152146	1	1001435	4014486459432
12		H176766	1	1001756	4014486519556
13	FOR HILLMASTER ONLY	H202821	1	1001759	4014486519563
16		AH139436	2	1001382	4014486474978
17		AH158880	2	1002861	4014486469400

### 9550

1	AIR CONDITIONING COMPRESSOR	H163515	1	1003209	4014486482256
3	ALTERNATOR (95 AMP)	H163515	1	1003209	4014486482256
3	ALTERNATOR (185 AMP)	H166870	1	1004090	4014486520521
4	BEATER DRIVE (100%)	AH139436	2	1001382	4014486474978
4	BEATER DRIVE (75%)	AH163931	2	1001381	4014486474961
5	CLEAN GRAIN ELEVATOR	H141166	1	1001394	4014486475128
6	CLEANING FAN (750 - 1350 RPM)	H152146	1	1001435	4014486459432
6	CLEANING FAN (490 - 980 RPM)	H152180	1	1001431	4014486459395
8	COUNTERSHAFT SECONDARY	H128010	1	1000797	4014486472165
9	CYLINDER INTERMEDIATE DRIVE BELT	H210476	1	1001543	4014486460636
10	CYLINDER DRIVE (240 - 960 RPM)	H115881	1	1003663	4014486490817
12	FEEDER HOUSE VARIABLE SPEED (STANDARD CAPACITY) (-700200)	H161648	1	No AP	
14	FIXED SPEED FEEDER HOUSE W/REVERSER (-700200)	H126345	1	1001124	4014486497106
14	FIXED SPEED FEEDER HOUSE W/REVERSER (700201-)	H156796	1	1004269	4014486683301
15	HEADER AND REEL PUMP (STANDARD)	H151952	1	1003570	4014486497014

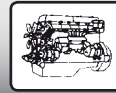
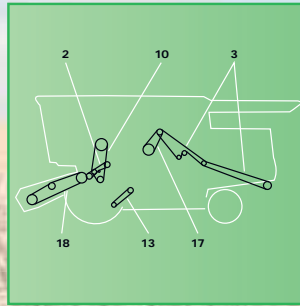
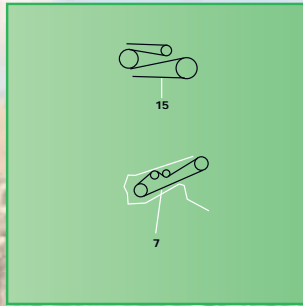
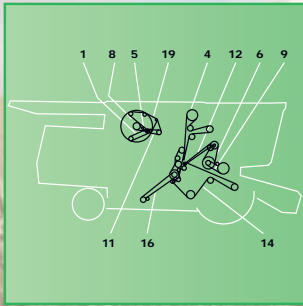

## JOHN DEERE

15	HEADER AND REEL PUMP (HIGH CAP.)	H155998	1	1000764	4014486471670
16	LOWER TAILINGS AUGER & ELEVATOR	N110085	1	1000702	4014486470857
17	ROTARY SCREEN (-695000)	H145158	1	No AP	
17	ROTARY SCREEN (695201)	H175632	1	1004469	4014486712117
19	SHOE, STRAW WALKER & CONVEYOR AUGERS	H131169	1	1001392	4014486475104
20	STRAW CHOPPER (STANDARD BALING)	H23950	1	1000682	4014486470581
21	STRAW SPREADER	H128234	1	1000419	4014486466829
22	UNLOADING SYSTEM	AH158880	2	1002861	4014486469400

### 9560

1		H175632	1	1004469	4014486712117
2		H115881	1	1003663	4014486490817
3		H177263	1	1001394	4014486475128
4		N110085	1	1000702	4014486470857
6	9560 / 9580	H146636	1	1004193	4014486558487
7	9560 / 9580	H177186	1	1003223	4014486482508
8		H176765	1	1001789	4014486519686
10		H177177	1	1001905	4014486489668
11		H152146	1	1001435	4014486459432
12		H176766	1	1001756	4014486519556
13	FOR HILLMASTER ONLY	H202821	1	1001759	4014486519563
16		AH139436	2	1001382	4014486474978
17		AH158880	2	1002861	4014486469400

### 9580

1		H175632	1	1004469	4014486712117
2		H115881	1	1003663	4014486490817
3		H177263	1	1001394	4014486475128
4		N110085	1	1000702	4014486470857
6	9560 / 9580	H146636	1	1004193	4014486558487
7	9560 / 9580	H177186	1	1003223	4014486482508
8		H176765	1	1001789	4014486519686
10		H177177	1	1001905	4014486489668
11		H152146	1	1001435	4014486459432
12		H176766	1	1001756	4014486519556
13	FOR HILLMASTER ONLY	H202821	1	1001759	4014486519563
16		AH139436	2	1001382	4014486474978
17		AH158880	2	1002861	4014486469400

### 9600

1	COOLING FAN	H132808	1	No AP	
2	ROTARY SCREEN DRIVE	H143869	1	No AP	
4	AIR CONDITIONING COMPRESSOR DRIVE	H134437	1	No AP	
5	CLEAN GRAIN ELEVATOR DRIVE	H141166	1	1001394	4014486475128
6	CYLINDER DRIVE INTERMEDIATE	H115759	1	1001543	4014486460636
7	UNLOADING SYSTEM	AH127866	2	1003765	4014486469394
7	CYLINDER DRIVE REGULAR DUAL RANGE	H115881	1	1003663	4014486490817
8	TAILINGS AUGER AND ELEVATOR (LOWER)	N110085	1	1000702	4014486470857
9	FOR ALTERNATOR	H134344	1	No AP	
10	COUNTERSHAFT (SECONDARY)	H128010	1	1000797	4014486472165
11	STRAW WALKER SHOE - CONVEYOR AUGERS	H131169	1	1001392	4014486475104
12		AH127866	2	1003765	4014486469394
13	STRAW CHOPPER DRIVE, FRONT	H125380	1	1000791	4014486472073
13	LONG REAR	H125381	1	1000778	4014486471885
14	REGULAR	H140404	1	1001434	4014486459425

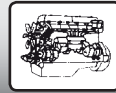

## JOHN DEERE

15	HEADER AND REEL PUMP	H125565	1	No AP	
15	HEADER AND REEL PUMP	H140160	1	1003570	4014486497014
16	FEEDER DRIVE VARIABLE SPEED	H125711	1	No AP	
17	BEATER (100 PERCENT BEATER SPEED)	AH139436	2	1001382	4014486474978
18	FEEDER HOUSE FIXED SPEED WITH REVERSER	H126345	1	1001124	4014486497106
19	STRAW SPREADER DRIVE	H128234	1	1000419	4014486466829

### 9610

1	AIR CONDITIONING COMPRESSOR	H163515	1	1003209	4014486482256
3	ALTERNATOR	H163515	1	1003209	4014486482256
4	BEATER DRIVE (100 PERCENT)	AH139436	2	1001382	4014486474978
4	BEATER DRIVE (75 PERCENT)	AH163931	2	1001381	4014486474961
5	CHOPPER IN REAR (OPERATING) POSITION	H125381	1	1000778	4014486471885
5	CHOPPER IN WINDROW OR FORWARD POSITION	H23950	1	1000682	4014486470581
6	CLEAN GRAIN ELEVATOR	H141167	1	1004088	4014486520088
7	COOLING FAN	H153297	1	1001551	4014486484502
8	CYLINDER DR. REGULAR DUAL RANGE & SINGLE RANGE	H115881	1	1003663	4014486490817
8	CYLINDER INTERMEDIATE DRIVE	H210476	1	1001543	4014486460636
9	ENGINE FAN	H153297	1	1001551	4014486484502
10	FEEDER HOUSE VARIABLE SPEED	H161648	1	No AP	
11	FIXED SPEED FEEDER HOUSE WITH REVERSER	H126345	1	1001124	4014486497106
12	FOR EXTENDED RANGE	H210476	1	1001543	4014486460636
13	HEADER AND REEL PUMP	H151952	1	1003570	4014486497014
14	LOWER TAILINGS AUGER & ELEVATOR	N110085	1	1000702	4014486470857
15	ROTARY SCREEN	H145158	1	No AP	
15	ROTARY SCREEN DRIVE	H146636	1	1004193	4014486558487
16	SECONDARY COUNTERSHAFT	H128010	1	1000797	4014486472165
17	SHOE, STRAW WALKER & CONVEYOR AUGERS	H131169	1	1001392	4014486475104
18	STRAW CHOPPER DRIVE, FRONT	H125380	1	1000791	4014486472073
18	STRAW CHOPPER DRIVE, REGULAR SPEED	H152146	1	1001435	4014486459432
18	STRAW CHOPPER DRIVE, SLOW SPEED	H152180	1	1001431	4014486459395
19	STRAW SPREADER	H128234	1	1000419	4014486466829
20	UNLOADING SYSTEM	AH158880	2	1002861	4014486469400

### 9640

1	9640	H175632	1	1004469	4014486712117
2		H115881	1	1003663	4014486490817
3		H177263	1	1001394	4014486475128
4		N110085	1	1000702	4014486470857
6		H146636	1	1004193	4014486558487
7	9640	H177186	1	1003223	4014486482508
8		H176765	1	1001789	4014486519686
10		H177177	1	1001905	4014486489668
11		H152146	1	1001435	4014486459432
12		H176766	1	1001756	4014486519556
13	FOR HILLMASTER ONLY	H202821	1	1001759	4014486519563
15		AH139436	2	1001382	4014486474978
16		AH158880	2	1002861	4014486469400

### 9650

1	AIR CONDITIONING COMPRESSOR	H163515	1	1003209	4014486482256
1		R164820	1	1003114	4014486480641
2	ALTERNATOR (95 AMP) (-695300)	H163515	1	1003209	4014486482256
2	ALTERNATOR (185 AMP) (-695300)	H166870	1	1004090	4014486520521
2	ALTERNATOR (185 AMP) (695301-)	R164820	1	1003114	4014486480641

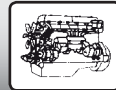

## JOHN DEERE

3	BEATER DRIVE (100%)	AH139436	2	1001382	4014486474978
3	BEATER DRIVE (75%)	AH163931	2	1001381	4014486474961
4	CLEAN GRAIN ELEVATOR	H141166	1	1001394	4014486475128
5	CLEANING FAN (750 - 1350 RPM)	H152146	1	1001435	4014486459432
5	CLEANING FAN (490 - 980 RPM)	H152180	1	1001431	4014486459395
6	COOLING FAN (-695300)	H153297	1	1001551	4014486484502
6	COOLING FAN (695301-)	H177186	1	1003223	4014486482508
7	COUNTERSHAFT SECONDARY	H128010	1	1000797	4014486472165
8	CYLINDER DRIVE (240 - 960 RPM)	H115881	1	1003663	4014486490817
8	CYLINDER INTERMEDIATE DRIVE BELT	H210476	1	1001543	4014486460636
10	FEEDER HOUSE VARIABLE SPEED (-700300)	H161648	1	No AP	
12	FIXED SPEED FEEDER HOUSE W/REVERSER (-700300)	H126345	1	1001124	4014486497106
12	FIXED SPEED FEEDER HOUSE W/REVERSER (700301-)	H156796	1	1004269	4014486683301
13	HEADER AND REEL PUMP (STANDARD)	H151952	1	1003570	4014486497014
13	HEADER AND REEL PUMP (HIGH CAP.)	H155998	1	1000764	4014486471670
14	LOWER TAILINGS AUGER & ELEVATOR	N110085	1	1000702	4014486470857
15	ROTARY SCREEN (-655300)	H145158	1	No AP	
15	ROTARY SCREEN DRIVE (695301-)	H146636	1	1004193	4014486558487
15	ROTARY SCREEN (695301-)	H175632	1	1004469	4014486712117
16	SHOE, STRAW WALKER & CONVEYOR AUGERS	H131169	1	1001392	4014486475104
17	STRAW CHOPPER (STANDARD BALING)	H23950	1	1000682	4014486470581
18	STRAW SPREADER	H128234	1	1000419	4014486466829
19	UNLOADING SYSTEM	AH158880	2	1002861	4014486469400
<b>9660</b>					
1	9660 / 9680	H175628	1	1000180	4014486462098
2		H115881	1	1003663	4014486490817
3		H177263	1	1001394	4014486475128
4		N110085	1	1000702	4014486470857
6		H146636	1	1004193	4014486558487
7	9660 / 9680	H174455	1	1003217	4014486482454
8		H176765	1	1001789	4014486519686
10		H177177	1	1001905	4014486489668
11		H152146	1	1001435	4014486459432
12		H176766	1	1001756	4014486519556
13	FOR HILLMASTER ONLY	H202821	1	1001759	4014486519563
15		AH139436	2	1001382	4014486474978
16		AH158880	2	1002861	4014486469400
<b>9680</b>					
1	9660 / 9680	H175628	1	1000180	4014486462098
2		H115881	1	1003663	4014486490817
3		H177263	1	1001394	4014486475128
4		N110085	1	1000702	4014486470857
6		H146636	1	1004193	4014486558487
7	9660 / 9680	H174455	1	1003217	4014486482454
8		H176765	1	1001789	4014486519686
10		H177177	1	1001905	4014486489668
11		H152146	1	1001435	4014486459432
12		H176766	1	1001756	4014486519556
13	FOR HILLMASTER ONLY	H202821	1	1001759	4014486519563
15		AH139436	2	1001382	4014486474978
16		AH158880	2	1002861	4014486469400

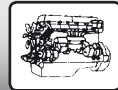

## JOHN DEERE

9880					
2	SEPARATOR VARIATOR HIGH HP	H207851	1	No AP	
3	SEPARATOR VARIATOR	H208431	1	No AP	
5	STRAW CHOPPER DRIVE	H217352	1	1001772	4014486519617

9935					
1		R123465	1	1003221	4014486482485

9980					
1	CLEAN GRAIN ELEVATOR DRIVE	H158512	1	1000853	4014486472844
2		H154723	1	1000738	4014486471335
3		AH150678	2	1002892	4014486470192
5	SHOE FAN AND CONVEYOR AUGERS	H175587	1	1004166	4014486523003
6	CLEANING FAN DRIVE	H165072	1	1001425	4014486459326
8		H154731	1	1000586	4014486469073
9		H175628	1	1000180	4014486462098
10		H178037	1	1002433	4014486493115
11		R135609	1	1003196	4014486481891
12	STRAW CHOPPER (REAR)	H156541	1	1001785	4014486519662
14		AH160080	2	1000681	4014486470550
16		H168301	1	1000708	4014486470956
17	STRAW CHOPPER JACKSHAFT DRIVE	H174367	1	1004686	4014486717853
19		H174885	1	1001777	4014486519631

JOHN DEERE					
		155538	1	1003090	4014486482676
		41959200	1	1004091	4014486473117
		84012974	1	1004093	4014486475791
		84238514	1	1004074	4014486520323
		4032807792	1	1004089	4014486520583
		4032807792	1	1004089	4014486520583
		7700068536	1	1004095	4014486481112
		01145789	2	1004094	4014486520019
		0554086.0	1	1004098	4014486520613
		0660316.0	1	1004099	4014486520606
		10VX00D	1	1004026	4014486519105
		600A01	1	1003993	4014486518702
		600A02	1	1003992	4014486518689
		600A07	1	1003999	4014486518887
		600A11	1	1003991	4014486518665
		600A16	1	1004004	4014486518955
		9351.0198.00	1	1004019	4014486519457
		AH228935	1	1004563	4014486721997
		AH233198	2	1004464	4014486715651
		AH236689	2	1000768	4014486471755
		AJ58940	1	1002580	4014486495591
		AS26639	2	1004882	4014486719062
		AS33603	1	1004855	4014486719864
		AXE10455	1	No AP	
		AXE10456	1	1004660	4014486718751
		AXE17661	1	No AP	
		AXE17662	1	No AP	
		AXE22550	1	No AP	
		AXE22550	1	No AP	

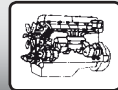

## JOHN DEERE

	AXE24473	1	1004499	4014486717037
	AXE25334	2	1004856	4014486718485
	AXE26321	2	1004626	4014486717587
	AXE27897	1	No AP	
	AXE29294	3	1004730	4014486719000
	AXE33418	2	1004564	4014486718461
	AXE33760	1	1002913	4014486484601
	AYC10132	2	1004882	4014486719062
	AYC10133	1	1004855	4014486719864
	AZ100807	3	1003826	4014486464559
	AZ100808	3	1003827	4014486464627
	AZ100809	3	1003828	4014486464702
	AZ100810	3	1003829	4014486464764
	AZ101386	3	1004731	4014486719017
	AZ25400	2	1002206	4014486477573
	AZ40077	2	1002843	4014486464085
	AZ41136	2	1002894	4014486469615
	AZ43804	2	1002819	4014486464443
	AZ43805	2	1000202	4014486462401
	AZ45824	2	1004803	4014486720471
	AZ46283	2	1002348	4014486478815
	AZ58519	1	1004672	4014486720600
	AZ61336	3	1003831	4014486474565
	AZ63883	2	1004416	4014486714821
	AZY83541	1	1004838	4014486719345
	B28170	1	1003106	4014486497953
	C17165	1	No AP	
	C19647	1	No AP	
	C22534	1	1000228	4014486463088
	CC100317	1	1003632	4014486488579
	CC100318	1	1001831	4014486488548
	CC100752	1	1003654	4014486489675
	CC100753	1	1001899	4014486489583
	CC100754	1	1001894	4014486489538
	CC102733	1	1001841	4014486488708
	CC107199	1	1004789	4014486721201
	CC109629	1	1004800	4014486720440
	CC119474	1	1004807	4014486720419
	CC18089	1	1000550	4014486468380
	CC19065	1	1001004	4014486487862
	CC21115	1	1001006	4014486487886
	CC26949	1	1001826	4014486488470
	CC26973	1	1001814	4014486488272
	CC32123	1	1004607	4014486719338
	CC32124	1	1004823	4014486720396
	CC38627	1	1002334	4014486478662
	CC38702	1	1004568	4014486717334
	CC38984	1	1004825	4014486720402
	CQ00626	1	1001126	4014486497120
	CQ00628	1	1001758	4014486487411
	CQ02867	1	No AP	
	CQ03160	1	No AP	
	CQ03265	1	1000603	4014486469370
	CQ03283	1	1002874	4014486472837
	CQ03457	1	1000684	4014486470628



## JOHN DEERE

	CQ03478	1	1000402	4014486466652
	CQ03492	1	1002811	4014486462920
	CQ05106	1	1001523	4014486460421
	CQ05208	1	1001123	4014486497090
	CQ06153	1	No AP	
	CQ08238	1	1000150	4014486461695
	CQ08239	1	1000151	4014486461718
	CQ12236	1	1000109	4014486461138
	CQ13375	1	1003404	4014486463255
	CQ13673	1	1000085	4014486460827
	CQ13800	1	1000035	4014486460728
	CQ17755	1	1000225	4014486463033
	CQ24186	1	1000363	4014486466225
	CQ24340	1	1000132	4014486461480
	CQ28344	1	1001736	4014486487206
	CQ31965	1	1001584	4014486484915
	CQ33577	1	1002520	4014486494358
	CQ33886	1	No AP	
	CQ34122	1	1002524	4014486494426
	CQ34237	1	1000129	4014486461442
	CQ34345	1	1001631	4014486485769
	CQ35417	1	1002655	4014486481327
	CQ35426	1	1001867	4014486489071
	CQ35531	1	1001565	4014486484687
	CQ35559	1	1001731	4014486487152
	CQ37755	1	1002427	4014486493047
	CQ39824	1	1001734	4014486487183
	CQ40221	1	1003955	4014486481105
	CQ40222	1	1001563	4014486484656
	CQ42066	1	1003143	4014486481006
	CQ42150	1	1000650	4014486470123
	CQ45617	1	1003783	4014486480856
	CQ48048	1	1001634	4014486485820
	CQ50143	1	1003238	4014486482713
	CQ50144	1	1003188	4014486481761
	CQ51920	1	1003131	4014486482683
	CQ51921	1	1003817	4014486481709
	CQ53362	1	1000610	4014486469479
	CQ53363	1	1001263	4014486492231
	CQ53364	1	1001886	4014486489422
	CQ53367	1	1003612	4014486486322
	CQ53369	1	1000244	4014486520156
	CQ53370	1	1001546	4014486460667
	CQ53371	1	1000592	4014486469189
	CQ53372	1	1001838	4014486488647
	CQ57311	2	1002749	4014486461510
	CQ58873	1	1003235	4014486482669
	CQ58875	1	1003183	4014486481662
	CQ61084	1	1004375	4014486714203
	CQ62911	1	1001137	4014486490169
	CQ62912	1	1001028	4014486487824
	CQ71838	1	1004693	4014486716436
	CQ71839	1	1004694	4014486716443
	DQ05106	1	No AP	
	DQ06154	1	No AP	





## JOHN DEERE

	DQ20810	1	1002560	4014486495102
	DQ23754	1	1002591	4014486495874
	DQ29594	2	1001107	4014486496895
	E41055	1	No AP	
	E46113	1	1003505	4014486469196
	EP0020	1	1000220	4014486462838
	FH10164	1	1001838	4014486488647
	FH10165	1	1001844	4014486488739
	FH305097	1	1004571	4014486717365
	H105040	1	1001968	4014486490794
	H138761	1	1000701	4014486470840
	H139436	1	No AP	
	H157105	1	No AP	
	H157523	1	1001633	4014486485783
	H160080	1	1000680	4014486470543
	H160831	1	1004455	4014486715569
	H161945	1	1004251	4014486675979
	H162310	1	1004598	4014486717914
	H163576	1	1001965	4014486490756
	H164368	1	1003830	4014486519747
	H166457	1	No AP	
	H166759	1	1000857	4014486472912
	H170047	1	1001548	4014486484472
	H172610	1	1003244	4014486482799
	H173024	1	No AP	
	H173832	1	1002685	4014486482546
	H174456	1	1003114	4014486480641
	H174457	1	1001777	4014486519631
	H175631	1	1004382	4014486714524
	H176536	1	1003126	4014486480795
	H176882	1	1001088	4014486496703
	H177442	1	1001917	4014486489835
	H177887	1	No AP	
	H178757	1	1003110	4014486480573
	H180896	1	No AP	
	H201571	1	1001633	4014486485783
	H201794	1	1000671	4014486470390
	H201916	1	1002436	4014486493146
	H204133	1	1004197	4014486675504
	H205169	1	No AP	
	H205240	1	1003230	4014486482621
	H206738	1	1001393	4014486475111
	H210001	1	1000678	4014486470512
	H210003	1	1000650	4014486470123
	H216026	1	1004130	4014486523126
	H221324	1	1000678	4014486470512
	H221327	1	1000650	4014486470123
	H224185	1	1001606	4014486485325
	H228261	1	1001996	4014486491203
	H228348	1	1004686	4014486717853
	H228523	1	1004618	4014486717488
	H232237	1	1000685	4014486470635
	H234704	1	No AP	
	H238679	1	1004355	4014486713992
	H238867	1	1004367	4014486714104



## JOHN DEERE

	H238869	1	1004798	4014486719468
	H238870	1	1004794	4014486719512
	H238871	1	1004790	4014486719475
	H240885	1	1000708	4014486470956
	H240888	1	1004890	4014486720587
	H240895	1	1004060	4014486518771
	H240972	1	1003528	4014486470277
	H240974	1	1004594	4014486717877
	H241000	1	No AP	
	H241000	1	No AP	
	H241212	1	1004850	4014486717204
	H241230	1	No AP	
	H241230	1	No AP	
	HXE10785	1	1003785	4014486481297
	HXE11255	1	1004137	4014486523416
	HXE12425	1	1004588	4014486717808
	HXE12426	1	1004573	4014486717389
	HXE12427	1	1004572	4014486717372
	HXE13951	1	1004604	4014486718508
	HXE13957	1	1004603	4014486718492
	HXE15546	1	1004816	4014486719352
	HXE15547	1	1004817	4014486719369
	HXE15556	1	1004475	4014486715743
	HXE15594	1	1004058	4014486518337
	HXE16928	1	1004551	4014486719871
	HXE17071	1	1002643	4014486480689
	HXE17164	1	1001576	4014486484816
	HXE17475	1	No AP	
	HXE19401	1	1004502	4014486717068
	HXE20763	1	1004534	4014486718409
	HXE22617	1	No AP	
	HXE24085	1	1004352	4014486713961
	HXE24086	1	1003368	4014486461060
	HXE24210	1	1000693	4014486470741
	HXE24687	1	1003159	4014486481235
	HXE24688	1	1003129	4014486480832
	HXE28843	1	1003221	4014486482485
	HXE29021	2	1004856	4014486718485
	HXE34473	1	1004535	4014486718393
	HXE34567	1	1004386	4014486713930
	HXE35822	1	1004868	4014486716344
	HXE35957	1	1004417	4014486714838
	HXE35958	1	1000124	4014486461367
	HXE36535	1	No AP	
	HXE38000	1	1004892	4014486717075
	HXE39119	1	1004606	4014486718522
	HXE39397	1	1001612	4014486485400
	HXE41402	1	1001196	4014486482034
	HXE43172	1	No AP	
	HXE43428	1	1003142	4014486480993
	HXE43696	1	No AP	
	HXE44273	1	1004372	4014486714173
	HXE46027	1	No AP	
	HXE46515	1	1004315	4014486715941
	HXE47062	1	No AP	

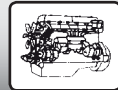

## JOHN DEERE

	HXE51300	1	1001394	4014486475128
	J57007	1	1002735	4014486496178
	J57065	1	1002737	4014486496192
	J57234	1	1002514	4014486494266
	L101166	1	1003205	4014486482102
	L110391	1	1003210	4014486482263
	L110599	1	1003091	4014486480368
	L11060	1	1001286	4014486482300
	L110600	1	1002633	4014486480375
	L110602	1	1002671	4014486482096
	L110603	1	1002672	4014486482119
	L110607	1	1003214	4014486482355
	L110608	1	1003216	4014486482393
	L110609	1	1003220	4014486482478
	L111087	1	No AP	
	L111148	1	1002635	4014486480399
	L111169	1	1002634	4014486480382
	L111602	1	1003244	4014486482799
	L111685	1	1003788	4014486481426
	L111801	1	1003799	4014486482553
	L111933	1	1003223	4014486482508
	L114286	1	1003815	4014486481686
	L114290	1	1003754	4014486482607
	L114292	1	1003242	4014486482751
	L114293	1	1003248	4014486482836
	L114468	1	1003245	4014486482805
	L114487	1	1003184	4014486481679
	L115657	1	1003214	4014486482355
	L115658	1	1003087	4014486482409
	L115659	1	No AP	
	L115660	1	1002669	4014486482072
	L115661	1	1002671	4014486482096
	L166309	1	1003790	4014486482690
	L172523	1	1004675	4014486720617
	L200916	1	1002696	4014486483147
	L201806	1	1002693	4014486483109
	L202229	1	1002697	4014486483154
	L202230	1	1002694	4014486483123
	L203293	1	1002695	4014486483130
	L203294	1	1004695	4014486716450
	L203295	1	1002698	4014486483161
	L203307	1	1004691	4014486716429
	L79344	1	1002679	4014486482225
	L79943	1	1003206	4014486482164
	L79945	1	1003220	4014486482478
	M45862	1	1000108	4014486461121
	M82461	1	1000098	4014486460988
	N153524	1	1003063	4014486497977
	N154241	1	1003064	4014486497922
	N157368	1	1003060	4014486558883
	N157369	1	1003061	4014486497915
	N371322	1	1003121	4014486480740
	P51165	1	1003755	4014486463507
	PT9483	1	No AP	
	R107324	1	1003810	4014486480719



## JOHN DEERE

	R108842	1	1003816	4014486481693
	R115257	1	1003092	4014486480313
	R116492	1	1000990	4014486481792
	R118318	1	1003220	4014486482478
	R120524	1	1003791	4014486481822
	R120852	1	1003164	4014486481365
	R122126	1	1003135	4014486480924
	R123292	1	1003798	4014486482379
	R123293	1	No AP	
	R123294	1	1003140	4014486480962
	R123296	1	1003142	4014486480993
	R123306	1	1003149	4014486481082
	R123307	1	1003134	4014486480917
	R123308	1	1003955	4014486481105
	R123432	1	1003141	4014486480986
	R123436	1	1003145	4014486481044
	R123437	1	1003139	4014486480955
	R123438	1	1003144	4014486481013
	R123439	1	1003136	4014486480931
	R123440	1	1003811	4014486480979
	R123441	1	1003782	4014486481037
	R123442	1	1003146	4014486481051
	R123445	1	1003148	4014486481075
	R123449	1	1003138	4014486480948
	R123450	1	1003143	4014486481006
	R123454	1	1002651	4014486481143
	R123456	1	1003147	4014486481068
	R123457	1	1003156	4014486481181
	R123458	1	1003158	4014486481204
	R123460	1	1002652	4014486481259
	R123461	1	1002650	4014486481136
	R123462	1	1003153	4014486481150
	R123463	1	1003152	4014486481129
	R123464	1	1003154	4014486481167
	R123466	1	1003223	4014486482508
	R123468	1	1003157	4014486481198
	R123470	1	1003222	4014486482492
	R123522	1	1003198	4014486481914
	R124785	1	1003118	4014486480702
	R124786	1	No AP	
	R125361	1	1003193	4014486481860
	R125752	1	1002655	4014486481327
	R128196	1	1003161	4014486481303
	R128197	1	1003787	4014486481389
	R128198	1	1003169	4014486481464
	R128199	1	1003172	4014486481495
	R128200	1	1002660	4014486481549
	R128201	1	1003176	4014486481570
	R128202	1	1003178	4014486481594
	R128203	1	1003180	4014486481617
	R128204	1	1002662	4014486481747
	R128205	1	1003191	4014486481846
	R128206	1	1003195	4014486481884
	R128208	1	1003199	4014486481938
	R128209	1	1003200	4014486481952

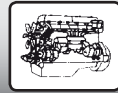

## JOHN DEERE

	R128806	1	1003075	4014486484168
	R129083	1	1003791	4014486481822
	R129738	1	1002686	4014486482720
	R130478	1	1003078	4014486484205
	R130852	1	1003128	4014486480825
	R130899	1	1003253	4014486482904
	R131433	1	1002683	4014486482430
	R131436	1	No AP	
	R132159	1	1003248	4014486482836
	R132925	1	1003081	4014486484243
	R133402	1	1003216	4014486482393
	R133518	1	1003195	4014486481884
	R133693	1	1003119	4014486480726
	R133694	1	1003111	4014486480580
	R133695	1	1003108	4014486480542
	R133696	1	1003112	4014486480603
	R133697	1	1003814	4014486481624
	R133699	1	1003127	4014486480818
	R133700	1	1003122	4014486480757
	R133701	1	1003117	4014486480672
	R133702	1	No AP	
	R133704	1	1003071	4014486484120
	R133705	1	1003070	4014486484113
	R133706	1	1003074	4014486484151
	R133707	1	1003080	4014486484229
	R133852	1	1003073	4014486484144
	R133853	1	1003203	4014486482058
	R134299	1	1002669	4014486482072
	R134594	1	1003230	4014486482621
	R134599	1	No AP	
	R134625	1	1003155	4014486481174
	R134630	1	1003077	4014486484199
	R134631	1	1003079	4014486484212
	R134634	1	1003076	4014486484175
	R134635	1	1003113	4014486480634
	R134636	1	1003109	4014486480559
	R134637	1	1000982	4014486481723
	R134638	1	1003124	4014486480771
	R135169	1	1003133	4014486480900
	R135188	1	1003234	4014486482645
	R135189	1	1003229	4014486482614
	R135192	1	1002652	4014486481259
	R135193	1	1002679	4014486482225
	R135194	1	1003224	4014486482515
	R135195	1	1003155	4014486481174
	R135198	1	1003260	4014486482782
	R135200	1	1003165	4014486481372
	R135568	1	1003164	4014486481365
	R135589	1	1003159	4014486481235
	R135590	1	1003161	4014486481303
	R135591	1	1003787	4014486481389
	R135592	1	1003167	4014486481440
	R135593	1	1003169	4014486481464
	R135594	1	1003170	4014486481471
	R135595	1	1003171	4014486481488

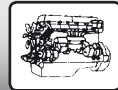

## JOHN DEERE

	R135596	1	1003172	4014486481495
	R135597	1	1003178	4014486481594
	R135598	1	1003174	4014486481525
	R135599	1	1002660	4014486481549
	R135600	1	1003176	4014486481570
	R135601	1	1003180	4014486481617
	R135602	1	1003184	4014486481679
	R135603	1	1002662	4014486481747
	R135604	1	1003189	4014486481785
	R135605	1	1003190	4014486481815
	R135607	1	1003194	4014486481877
	R135608	1	1003195	4014486481884
	R135611	1	1003200	4014486481952
	R135612	1	1003246	4014486482812
	R135613	1	1003248	4014486482836
	R135614	1	1003804	4014486482942
	R135615	1	1002687	4014486482850
	R135663	1	1003802	4014486482881
	R135664	1	1003254	4014486482911
	R135665	1	1003256	4014486482973
	R135680	1	1003158	4014486481204
	R135681	1	1003143	4014486481006
	R135824	1	1003174	4014486481525
	R135826	1	1003749	4014486481228
	R135977	1	1003749	4014486481228
	R136284	1	1003209	4014486482256
	R136535	1	1003163	4014486481358
	R156049	1	1003237	4014486482706
	R156050	1	1003239	4014486519327
	R175712	1	1003180	4014486481617
	R175825	1	1003068	4014486484090
	R175826	1	1003192	4014486481853
	R181917	1	1003245	4014486482805
	R181918	1	1003264	4014486483079
	R202628	1	1003243	4014486482768
	R211183	1	1003119	4014486480726
	R239551	1	No AP	
	R300380	1	No AP	
	R300399	1	No AP	
	R500089	1	1003166	4014486481402
	R500090	1	1003249	4014486482843
	R500244	1	1003219	4014486482461
	R500377	1	1003152	4014486481129
	R500378	1	1003240	4014486482737
	R500379	1	No AP	
	R500380	1	1003088	4014486482539
	R500381	1	1003217	4014486482454
	R500382	1	1003089	4014486482577
	R500383	1	1003955	4014486481105
	R500384	1	1003148	4014486481075
	R500385	1	1003242	4014486482751
	R500616	1	No AP	
	R501007	1	1003132	4014486480894
	R501017	1	1003130	4014486480887
	R501053	1	1003160	4014486481242

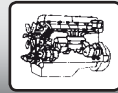

## JOHN DEERE

	R501191	1	1003258	4014486483017
	R501266	1	1003120	4014486480733
	R501308	1	1003241	4014486482744
	R501526	1	1003265	4014486483000
	R502016	1	1003204	4014486482065
	R502078	1	1003259	4014486483024
	R502086	1	1003197	4014486481907
	R502089	1	1003262	4014486482829
	R502186	1	1003193	4014486481860
	R502306	1	1003082	4014486484250
	R502416	1	1003754	4014486482607
	R502417	1	1001196	4014486482034
	R502418	1	1002665	4014486481983
	R502461	1	No AP	
	R502476	1	1003168	4014486481457
	R503311	1	1003072	4014486484137
	R503323	1	1003066	4014486484076
	R503324	1	1003123	4014486480764
	R503571	1	1003250	4014486482867
	R503726	1	1003129	4014486480832
	R503932	1	1003208	4014486482218
	R504022	1	1002651	4014486481143
	R504023	1	1003225	4014486482522
	R504618	1	1003220	4014486482478
	R504963	1	1003142	4014486480993
	R505186	1	1003749	4014486481228
	R505812	1	1003094	4014486480436
	R515127	1	1001017	4014486481921
	R515209	1	1003210	4014486482263
	R515217	1	1003095	4014486480443
	R515219	1	1003096	4014486480429
	R515220	1	1003097	4014486480450
	R517012	1	1003099	4014486480504
	R517039	1	1003100	4014486480498
	R517041	1	1003101	4014486480481
	R94373	1	1003812	4014486481310
	R98510	1	1003784	4014486481266
	S07074	1	1001757	4014486487404
	S07075	1	1001112	4014486496956
	S13042	1	1001412	4014486459197
	S165708	1	No AP	
	S17044	1	1000033	4014486460704
	S17045	1	1000144	4014486461626
	S26382	1	No AP	
	S33510	1	1000609	4014486469486
	S33512	1	1004198	4014486485141
	S33602	1	No AP	
	S33607	1	1004199	4014486675498
	S33721	1	No AP	
	S37687	1	No AP	
	S60001	1	1000569	4014486468779
	S60004	1	1000569	4014486468779
	S60011	1	1001851	4014486488852
	S60016	1	1000553	4014486468434
	S60018	1	1000623	4014486469684

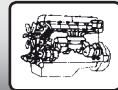

## JOHN DEERE

	S60021	1	1001996	4014486491203
	S60022	1	1000607	4014486469455
	SA00101	1	1000703	4014486470871
	SA00201	1	1000717	4014486471076
	SA00301	1	1000538	4014486468199
	SA00401	1	1000646	4014486470062
	SA00501	1	No AP	
	SA00601	1	1000686	4014486470642
	SA35274	1	1004326	4014486720945
	SA35425	1	1004334	4014486721461
	SA36024	1	1004320	4014486721485
	SA36101	1	1004321	4014486720891
	SA36130	1	1004674	4014486713886
	SA36192	1	1004323	4014486720914
	SA36521	1	1004815	4014486721195
	SA36523	1	1004328	4014486720969
	SA36536	1	1004309	4014486713909
	SA36701	1	1004324	4014486720921
	SA36717	1	1004325	4014486720938
	SAU10552	1	1004331	4014486720990
	SAU10691	1	1004335	4014486721478
	SAU11073	1	1004336	4014486721003
	SAU11158	1	1004332	4014486721454
	SAU11284	1	1004333	4014486721447
	SAU11321	1	1004327	4014486720952
	SAU11644	1	1004329	4014486720976
	SAU11645	1	1004330	4014486720983
	SAU12081	1	1004322	4014486720907
	T148208	1	1003175	4014486481556
	T155457	1	1002655	4014486481327
	T160034	1	1003171	4014486481488
	T160036	1	1003181	4014486481631
	T164949	1	1002643	4014486480689
	T166823	1	1003115	4014486480658
	T178409	1	1003171	4014486481488
	T178410	1	1003162	4014486481341
	T178411	1	1003806	4014486483031
	T178412	1	1003257	4014486482997
	T178413	1	1003174	4014486481525
	T178414	1	1003166	4014486481402
	T178415	1	1003147	4014486481068
	T178416	1	1003251	4014486482874
	T178417	1	1003154	4014486481167
	T178418	1	1003116	4014486480665
	T178419	1	1002662	4014486481747
	T178420	1	1003143	4014486481006
	T178421	1	1003791	4014486481822
	T178422	1	1003156	4014486481181
	T178423	1	1003200	4014486481952
	T178465	1	No AP	
	T178536	1	1003179	4014486481600
	T178538	1	1003813	4014486481501
	T178539	1	No AP	
	T178548	1	1003808	4014486483093
	T180368	1	1003233	4014486482638



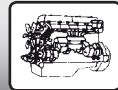

## JOHN DEERE

	T182169	1	1003086	4014486484304
	T184590	1	1003229	4014486482614
	T184592	1	1003184	4014486481679
	T184594	1	1003749	4014486481228
	T184595	1	1003225	4014486482522
	T185061	1	1003172	4014486481495
	T185081	1	1003182	4014486481648
	T186776	1	1002650	4014486481136
	T187391	1	1003085	4014486484298
	T187704	1	No AP	
	T189016	1	No AP	
	T190384	1	1003225	4014486482522
	T190809	1	1002658	4014486481433
	T190810	1	No AP	
	T190817	1	1003176	4014486481570
	VK648204	1	1004584	4014486717761
	VK648215	1	1001826	4014486488470
	VK648216	1	1004589	4014486717815
	VK648223	3	1004395	4014486714616
	Z101214	1	1004349	4014486716122
	Z103479	1	1004381	4014486714517
	Z103583	1	1004753	4014486719116
	Z103861	1	1004467	4014486715699
	Z103867	1	1000701	4014486470840
	Z104104	1	1004884	4014486719130
	Z104978	1	1004885	4014486719154
	Z105041	1	1003590	4014486460629
	Z105506	1	1002642	4014486480627
	Z106227	1	No AP	
	Z21399	1	No AP	
	Z22556	1	No AP	
	Z23087	1	1004454	4014486715552
	Z23475	1	1004841	4014486715453
	Z23476	1	1004841	4014486715453
	Z24729	1	1004842	4014486715590
	Z25670	1	1001118	4014486497038
	Z27710	1	1001102	4014486496840
	Z28842	1	1003571	4014486496994
	Z30881	1	1000766	4014486471694
	Z31867	1	No AP	
	Z32158	1	1004437	4014486715361
	Z34121	1	1003586	4014486460049
	Z35357	1	1003621	4014486487046
	Z35358	1	1003361	4014486485752
	Z36376	1	1001452	4014486459609
	Z36499	1	1003543	4014486470932
	Z36770	1	1003752	4014486471489
	Z36771	1	1001682	4014486486537
	Z37121	1	1004106	4014486522815
	Z38699	1	1003389	4014486462517
	Z38708	1	1003497	4014486468830
	Z39750	1	1004673	4014486713879
	Z43808	1	1002354	4014486478877
	Z44762	1	1001723	4014486487060
	Z48472	1	1004727	4014486716535

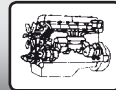
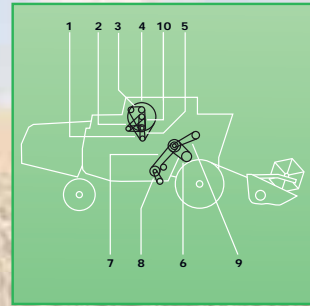
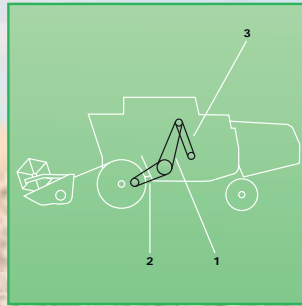
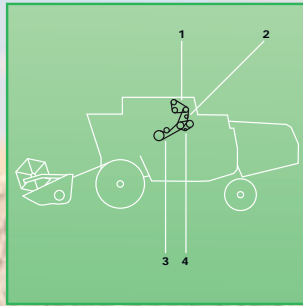
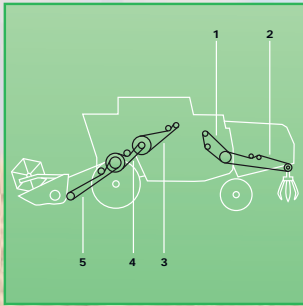

## JOHN DEERE

		Z51089	1	1001689	4014486486636
		Z51202	1	1001733	4014486487176
		Z52009	1	1002575	4014486495478
		Z53478	1	1001737	4014486487213
		Z54332	1	1004183	4014486554380
		Z56313	1	1000305	4014486465105
		Z56351	1	1004184	4014486554342
		Z56352	1	1004185	4014486554359
		Z56829	1	1000316	4014486465334
		Z59435	1	No AP	
		Z59930	1	1001734	4014486487183
		Z63322	1	1003832	4014486475074
		Z66787	1	1001097	4014486496796
		Z66873	1	1001924	4014486489927
		Z67285	1	1000299	4014486464955
		Z67326	1	1001926	4014486489941
		Z73506	1	1003268	4014486482294
		Z73879	1	1000631	4014486469837
		Z75245	1	1003201	4014486481976
		Z75246	1	1003266	4014486483116
		Z77222	1	1002692	4014486483086
		Z78834	1	1004069	4014486520200
		Z78860	1	No AP	
		Z81070	1	1003083	4014486484274
		Z81937	1	1004809	4014486720501
		ZY86859	1	1004384	4014486714548
		ZY87107	1	No AP	
		ZY94047	1	1004431	4014486715309
		ZY94115	1	1000671	4014486470390
		ZY95337	1	1000796	4014486472158
		ZY96551	1	1004433	4014486715323
		ZY96558	1	1000680	4014486470543

### 1072 - 1075 - 1075 HYDRO 4

1	FAN DRIVE - 1075 (TO NR 44386)	AR72036	1	1002351	4014486478846
4	1072 (FROM NR. 39787) - 1075-1075 HY4 (FROM NR. 44387)	Z34786	1	1000040	4014486460773
4	ROTARY SCREEN - 1075 HY 4 (TO NR. 44386)	Z37192	1	1004106	4014486522815
5	ROTARY SCREEN 1072 - 1075	Z32190	1	1000002	4014486458985
5	ROTARY SCREEN - 1075 HY 4 (TO NR. 44386)	Z37191	1	1004105	4014486522761
5	ROTARY SCREEN - 1075 HY 4 (FROM NR. 44387)	Z45191	1	1000003	4014486458992
6	CYLINDER VARIATOR DRIVE (1072)	Z20823	1	1003587	4014486460230
6	CYLINDER DRIVE - 1075 + 1075 HY 4	Z37473	1	1003589	4014486460315
7	FAN DRIVE VARIABLE SPEED	Z34405	1	1000675	4014486470475
8	FAN DRIVE VARIABLE SPEED	Z41178	1	1001396	4014486459012
9	FROM NR. 44137	Z45026	1	1000261	4014486464177
10	1075 HY 4 (FROM NR. 44387)	Z45192	1	1002425	4014486493023
11	SHAKER SHAFT DRIVE	Z35965	1	1000153	4014486461756
12	STRAW WALKER DRIVE	Z33774	1	1000401	4014486466645
13		Z33790	1	1001995	4014486491180
14	MAIN DRIVE (GRAIN)	Z21501	1	1001102	4014486496840
14	MAIN DRIVE - 1075/1075 HY 4 (MAIZE)	Z38186	1	1001647	4014486485998
15	CUTTING TABLE DRIVE - 1072	Z39313	1	1001109	4014486496925
15	CUTTING TABLE DRIVE - 1075/1075 HY 4	Z39314	1	1001121	4014486497076
21	AIR CONDITIONING COMPRESSOR DRIVE SUB. FOR Z41889	Z42756	1	1002350	4014486478839
22		Z42757	1	1003343	4014486462975



## JOHN DEERE

23	HYDRAULIC PUMP DRIVE	Z34828	1	1003397	4014486462821
24	DISCHARGE BEATER DRIVE	Z47911	1	1000604	4014486469363
31	MAIN DRIVE (1075)	AZ22914	2	1002915	4014486496918
32	1075	Z34099	1	1001523	4014486460421
33	1075 HY 4	Z41728	1	1001828	4014486488494
41		Z43863	1	1000036	4014486460735
<b>1075 HYDRO 4</b>					
1	CUTTING TABLE DRIVE LEAD-IN	Z33790	1	1001995	4014486491180
2	DISCHARGE BEATER DRIVE	Z33368	1	1000603	4014486469370
3	AIR CONDITIONING COMPRESSOR DRIVE	CA22534	1	1000228	4014486463088
4	HYDROSTATIC PUMP DRIVE	Z34828	1	1003397	4014486462821
5	SHAKER SHAFT DRIVE	Z35965	1	1000153	4014486461756
7	LEAD-IN DRIVE	Z21501	1	1001102	4014486496840
7	LEAD-IN DRIVE	Z38186	1	1001647	4014486485998
8	CUTTING TABLE DRIVE	Z39314	1	1001121	4014486497076
10	ROTARY SCREEN DRIVE	Z34786	1	1000040	4014486460773
10	ROTARY SCREEN DRIVE	Z37192	1	1004106	4014486522815
11	ROTARY SCREEN DRIVE	Z37191	1	1004105	4014486522761
12	CYLINDER VARIATOR DRIVE	Z37473	1	1003589	4014486460315
13	FAN DRIVE VARIABLE SPEED	Z34405	1	1000675	4014486470475
14	FAN DRIVE VARIABLE SPEED	Z41178	1	1001396	4014486459012
16	REEL DRIVE VARIABLE SPEED	Z36813	1	1001397	4014486459036
17	REEL DRIVE VARIABLE SPEED	Z20562	1	1000753	4014486471526
18	HYDROSTATIC PUMP DRIVE	Z41728	1	1001828	4014486488494
22	STRAW WALKER DRIVE	Z33774	1	1000401	4014486466645
<b>1085 - 1085 HYDRO 4</b>					
2	FAN DRIVE (TO NR. 44386)	Z38703	1	1002344	4014486478778
4	ROTARY SCREEN - 1085 (TO NR. 44386) - 1085 HY4	Z38704	1	1000039	4014486460766
6	CYLINDER VARIATOR DRIVE	Z37473	1	1003589	4014486460315
7	FAN DRIVE VARIABLE SPEED	Z34405	1	1000675	4014486470475
8	FAN DRIVE VARIABLE SPEED	Z41178	1	1001396	4014486459012
9	1085 (FROM NR. 44387)	Z45191	1	1000003	4014486458992
10	1085 (FROM NR. 44387)	Z34786	1	1000040	4014486460773
12	1085 (FROM NR. 44387)	Z45192	1	1002425	4014486493023
12	1085 HY 4 (FROM NR. 44387)	Z45367	1	1002426	4014486493030
13	FROM NR. 44137	Z45026	1	1000261	4014486464177
21	SHAKER SHAFT DRIVE	Z35965	1	1000153	4014486461756
22	STRAW WALKER DRIVE	Z33774	1	1000401	4014486466645
23	CUTTING TABLE DRIVE LEAD-IN - 1085 (FROM NR. 44387)	Z33790	1	1001995	4014486491180
23	CUTTING TABLE DRIVE LEAD-IN - 1085 (TO NR. 44386) - 1085 HY4	Z38697	1	1001996	4014486491203
24		Z43890	1	1003643	4014486489156
31		Z42756	1	1002350	4014486478839
32	AIR CONDITIONING COMPRESSOR DRIVE (FROM NR. 33563)	Z42758	1	1000228	4014486463088
33	HYDRAULIC PUMP DRIVE	Z34828	1	1003397	4014486462821
34		Z47912	1	1000607	4014486469455
41	MAIN DRIVE (1085)	AZ22914	2	1002915	4014486496918
42	MAIN DRIVE (1085)	Z34099	1	1001523	4014486460421
51		Z43863	1	1000036	4014486460735
<b>1166 - 1166 HYDRO 4</b>					
2	1166	AZ37807	2	1001108	4014486496901
3	1166	Z34099	1	1001523	4014486460421
5	1166	Z42756	1	1002350	4014486478839

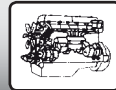
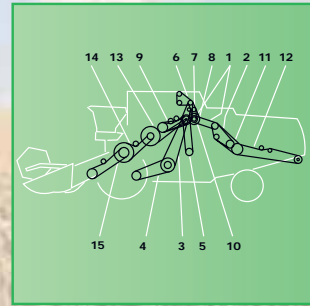
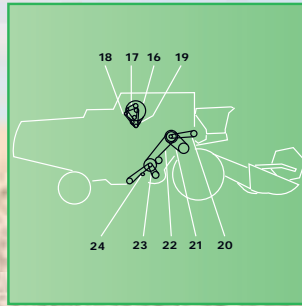
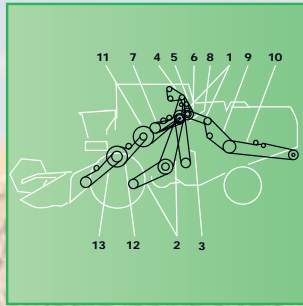
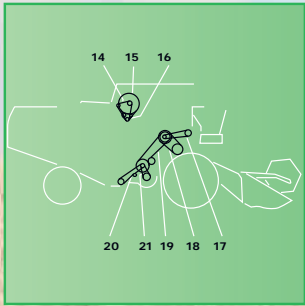

## JOHN DEERE

6	1166	Z45482	1	1003400	4014486462906
7		Z34828	1	1003397	4014486462821
8		Z51212	1	1001027	4014486487800
9		Z46759	1	1002333	4014486478648
10		Z35965	1	1000153	4014486461756
12		Z33790	1	1001995	4014486491180
13	DRIVE GRAIN	Z21501	1	1001102	4014486496840
13	MAIZE	Z38186	1	1001647	4014486485998
14		Z39313	1	1001109	4014486496925
14	FOR LONG FEEDER HOUSE	Z39314	1	1001121	4014486497076
15		AR72036	1	1002351	4014486478846
16		Z46764	1	1004107	4014486522822
17		Z32190	1	1000002	4014486458985
18		Z45026	1	1000261	4014486464177
19		Z20823	1	1003587	4014486460230
19		Z44936	1	1001542	4014486460612
19	SUB FOR Z20823	Z53288	1	1001507	4014486460223
21		Z47912	1	1000607	4014486469455
22		Z46365	1	1001404	4014486459104
23	1166	Z43863	1	1000036	4014486460735

### 1169 - 1169 HYDRO 4

4	AIR CONDITIONING COMPRESSOR DRIVE WITH SEPARATE CONDENSER COOLING - 1169	Z42756	1	1002350	4014486478839
5	ONLY 1169	Z45482	1	1003400	4014486462906
6		Z34828	1	1003397	4014486462821
7		Z51212	1	1001027	4014486487800
8	AIR CONDITIONING COMPRESSOR DRIVE	Z46759	1	1002333	4014486478648
9		Z35965	1	1000153	4014486461756
11		Z33790	1	1001995	4014486491180
12	MAIZE	Z21501	1	1001102	4014486496840
12	DRIVE GRAIN	Z38186	1	1001647	4014486485998
13		Z39312	1	1001118	4014486497038
14		AR72036	1	1002351	4014486478846
15		Z46764	1	1004107	4014486522822
16		Z32190	1	1000002	4014486458985
17		Z45026	1	1000261	4014486464177
18		Z20823	1	1003587	4014486460230
18	SUB FOR Z20823	Z53288	1	1001507	4014486460223
20		Z47912	1	1000607	4014486469455
21		Z46365	1	1001404	4014486459104

### 1174 - 1174 HYDRO 4

1		Z43863	1	1000036	4014486460735
2		Z38704	1	1000039	4014486460766
3	1174 - FOR POSI-TORQUE GROUND SPEED DRIVE	AZ37807	2	1001108	4014486496901
4	1174 - FOR POSI-TORQUE GROUND SPEED DRIVE	Z34099	1	1001523	4014486460421
5	1174 HY 4 ONLY	Z41728	1	1001828	4014486488494
6	AIR CONDITIONING WITH SEPARATE CONDENSER COOLING	Z42756	1	1002350	4014486478839
7		Z45482	1	1003400	4014486462906
8		Z34828	1	1003397	4014486462821
9		Z51212	1	1001027	4014486487800
10	AIR CONDITIONING WITH INTEGRATED CONDENSER COOLING	Z46759	1	1002333	4014486478648
11		Z35965	1	1000153	4014486461756
13		Z33790	1	1001995	4014486491180

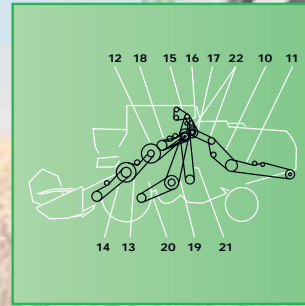
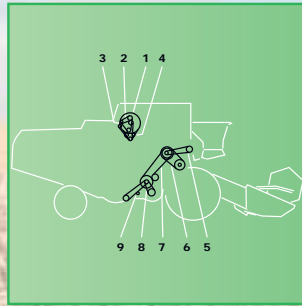
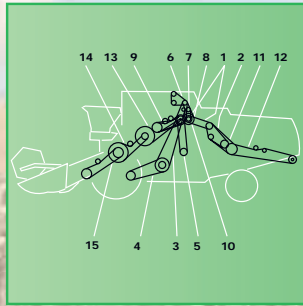
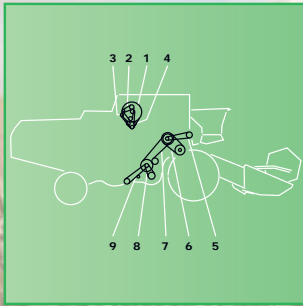

## JOHN DEERE

14		Z21501	1	1001102	4014486496840
14		Z38186	1	1001647	4014486485998
15		Z39313	1	1001109	4014486496925
15	FOR FEEDER CONVEYOR LONG	Z39314	1	1001121	4014486497076
16	AIR CONDITIONING WITH SEPARATE CONDENSER COOLING	Z38704	1	1000039	4014486460766
16	1174 ONLY AC WITH INTEGRATED CONDENSER COOLING	Z46764	1	1004107	4014486522822
17		AR72036	1	1002351	4014486478846
18	1174 HY 4 ONLY	Z45367	1	1002426	4014486493030
19		Z32190	1	1000002	4014486458985
20		Z45026	1	1000261	4014486464177
21		Z20823	1	1003587	4014486460230
21		Z44936	1	1001542	4014486460612
21	SUB FOR Z20823	Z53288	1	1001507	4014486460223
23		Z46365	1	1001404	4014486459104
24		Z47912	1	1000607	4014486469455

### 1177 - 1177 HYDRO 4

1	1177 ONLY- AC WITH INTEGRATED CONDENSER COOLING	Z46764	1	1004107	4014486522822
2	1177 ONLY	AR72036	1	1002351	4014486478846
3		Z45367	1	1002426	4014486493030
5		Z45026	1	1000261	4014486464177
6		Z44936	1	1001542	4014486460612
8		Z46365	1	1001404	4014486459104
9		Z47912	1	1000607	4014486469455
10		Z35965	1	1000153	4014486461756
12	1177 ONLY	Z33790	1	1001995	4014486491180
13		Z38186	1	1001647	4014486485998
14		Z39314	1	1001121	4014486497076
15	AIR CONDITIONING WITH SEPARATE CONDENSER COOLING	Z42756	1	1002350	4014486478839
16	1177 HY 4	Z42757	1	1003343	4014486462975
16	1177 ONLY	Z45482	1	1003400	4014486462906
17		Z34828	1	1003397	4014486462821
18		Z51212	1	1001027	4014486487800
19	1177 ONLY- AC WITH INTEGRATED CONDENSER COOLING	Z46759	1	1002333	4014486478648
20	1177	AZ37807	2	1001108	4014486496901
21	1177	Z34099	1	1001523	4014486460421
22	1177 HY 4	Z46709	1	1001832	4014486488555
23		Z43863	1	1000036	4014486460735
24	WITHOUT CROOS SHAKER	Z38704	1	1000039	4014486460766

### 1188 - 1188 HYDRO 4

1		Z38704	1	1000039	4014486460766
3		Z45367	1	1002426	4014486493030
5		Z45026	1	1000261	4014486464177
6		Z44936	1	1001542	4014486460612
8		Z46365	1	1001404	4014486459104
9		Z47912	1	1000607	4014486469455
10		Z35965	1	1000153	4014486461756
12		Z46463	1	1001261	4014486492200
13		Z43890	1	1003643	4014486489156
14	FOR FEEDER CONVEYOR LONG	Z43889	1	1002707	4014486486452
15		Z42756	1	1002350	4014486478839
17		Z34828	1	1003397	4014486462821
18		Z51212	1	1001027	4014486487800
20	1188 ONLY	Z34099	1	1001523	4014486460421

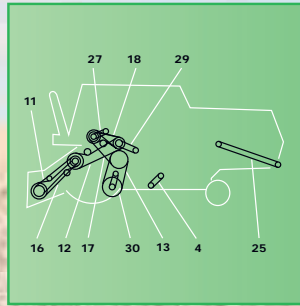
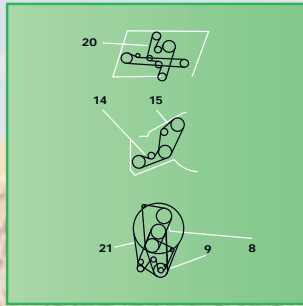
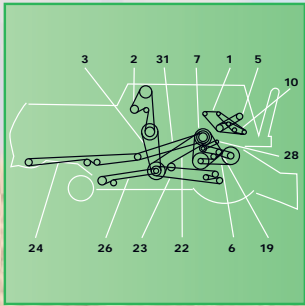

## JOHN DEERE

22		Z43863	1	1000036	4014486460735
		Z51707	1	1001634	4014486485820

### 4435 - 4435 HYDRO

1	ALTERNATOR AND WATERPUMP DRIVE	AR72036	1	1002351	4014486478846
2	CENTER SHAFT TO ROTARY SCREEN	Z46764	1	1004107	4014486522822
3	CRANKSHAFT - CENTER SHAFT	Z32190	1	1000002	4014486458985
4	CLEANING FAN DRIVE	Z46365	1	1001404	4014486459104
6	CYLINDER	Z44936	1	1001542	4014486460612
7	TAILINGS ELEVATOR DRIVE	Z45026	1	1000261	4014486464177
8	CLEAN GRAIN ELEVATOR DRIVE	Z47912	1	1000607	4014486469455
10	BEATER DRIVE	Z33790	1	1001995	4014486491180
11	FEEDER HOUSE DRIVE	Z38186	1	1001647	4014486485998
12	STRAW CHOPPER (FRONT)	Z44761	1	1001668	4014486486315
13	STRAW CHOPPER DRIVE (REAR)	Z47763	1	1001735	4014486487190
14	MAIN HYDRAULIC PUMP	Z34828	1	1003397	4014486462821
15	COMPRESSOR DRIVE	Z46759	1	1002333	4014486478648
16	UNLOADING AUGER DRIVE	Z51212	1	1001027	4014486487800
17	GROUND DRIVE (UPPER)	AZ37807	2	1001108	4014486496901
18	GROUND DRIVE (LOWER)	Z34099	1	1001523	4014486460421
21		Z55645	1	1001739	4014486487237

### 6600 SIDEHILL

18	COUNTERSHAFT (PRIMARY)	H108175	1	1001140	4014486490022
----	------------------------	---------	---	---------	---------------

### 6700 S

1		R135199	1	1003235	4014486482669
---	--	---------	---	---------	---------------

### 9500 SH

1	AIR CONDITIONING COMPRESSOR (SN 650201-)	H80896	1	1002570	4014486495355
1	AIR COND. COMPRESSOR (635201 - 648500)	H81742	1	No AP	
2	BEATER (100 PERCENT)	AH139436	2	1001382	4014486474978
2	BEATER DRIVE (75 PERCENT)	AH163931	2	1001381	4014486474961
3	CLEAN GRAIN ELEVATOR (SN 640201-)	H141167	1	1004088	4014486520088
4	COOLING FAN (HIGH POWER)	H153297	1	1001551	4014486484502
5	CYLINDER DR. REGULAR DUAL RANGE & SINGLE RANGE	H115881	1	1003663	4014486490817
5	CYLINDER INTERMEDIATE DRIVE BELT	H210476	1	1001543	4014486460636
6	ENGINE ALTERNATOR (SN 645201-)	H101813	1	1002580	4014486495591
6	ENGINE ALTERNATOR	H134344	1	No AP	
7	FIXED SPEED FEEDER HOUSE WITH REVERSER	H126345	1	1001124	4014486497106
8	HEADER & REEL PUMP (SN 635201-)	H151952	1	1003570	4014486497014
9	LOWER TAILINGS AUGER & ELEVATOR	N110085	1	1000702	4014486470857
10	OPTIONAL BEATER (75 PERCENT)	AH163931	2	1001381	4014486474961
11	ROTARY SCREEN (SN -642578)	H143869	1	No AP	
11	ROTARY SCREEN (SN 642579-)	H145158	1	No AP	
11	ROTARY SCREEN DRIVE (SN 642579-)	H146636	1	1004193	4014486558487
12	SECONDARY COUNTERSHAFT	H128010	1	1000797	4014486472165
13	SHOE, STRAW WALKER & CONVEYOR AUGERS	H131169	1	1001392	4014486475104
14	STRAW CHOPPER DRIVE, FRONT	H125380	1	1000791	4014486472073
14	STRAW CHOPPER DRIVE, LONG REAR	H125381	1	1000778	4014486471885
14	STRAW CHOPPER DRIVE, REGULAR	H140404	1	1001434	4014486459425
14	STRAW CHOPPER DRIVE, SHORT REAR (SN 640201-)	H23950	1	1000682	4014486470581
15	STRAW SPREADER	H128234	1	1000419	4014486466829
16	UNLOADING SYSTEM	AH158880	2	1002861	4014486469400
17	VARIABLE SPEED FEEDER HOUSE	H161648	1	No AP	

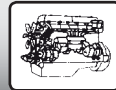

## JOHN DEERE

### 9510 SH

1	AIR CONDITIONING COMPRESSOR	H80896	1	1002570	4014486495355
3	BEATER DRIVE (100 PERCENT)	AH139436	2	1001382	4014486474978
3	BEATER DRIVE (75 PERCENT)	AH163931	2	1001381	4014486474961
4	CHOPPER IN REAR (OPERATING) POSITION	H125381	1	1000778	4014486471885
4	CHOPPER IN WINDROW OR FORWARD POSITION	H23950	1	1000682	4014486470581
6	COOLING FAN LOW POWER	H132808	1	No AP	
7	CYLINDER DR. REGULAR DUAL RANGE & SINGLE RANGE	H115881	1	1003663	4014486490817
8	ENGINE ALTERNATOR	H101813	1	1002580	4014486495591
10	FIXED SPEED FEEDER HOUSE WITH REVERSER	H126345	1	1001124	4014486497106
10	FEEDER HOUSE VARIABLE SPEED	H161648	1	No AP	
11	LOWER TAILINGS AUGER & ELEVATOR	N110085	1	1000702	4014486470857
12	POWERSHAFT AND REEL PUMP	H151952	1	1003570	4014486497014
13	ROTARY SCREEN	H145158	1	No AP	
13	ROTARY SCREEN DRIVE	H146636	1	1004193	4014486558487
14	SECONDARY COUNTERSHAFT	H128010	1	1000797	4014486472165
15	SHOE, STRAW WALKER & CONVEYOR AUGERS	H131169	1	1001392	4014486475104
16	STRAW CHOPPER DRIVE, FRONT	H125380	1	1000791	4014486472073
16	STRAW CHOPPER DRIVE, REGULAR (750-1350 RPM)	H140404	1	1001434	4014486459425
17	STRAW SPREADER	H128234	1	1000419	4014486466829
19	UNLOADING SYSTEM	AH158880	2	1002861	4014486469400

### 9550 SH

1	AIR CONDITIONING COMPRESSOR	H163515	1	1003209	4014486482256
2	ALTERNATOR (95 AMP)	H163515	1	1003209	4014486482256
2	ALTERNATOR (185 AMP)	H166870	1	1004090	4014486520521
3	BEATER DRIVE (100%)	AH139436	2	1001382	4014486474978
3	BEATER DRIVE (75%)	AH163931	2	1001381	4014486474961
4	CLEAN GRAIN ELEVATOR	H141166	1	1001394	4014486475128
5	CLEANING FAN (750 - 1350 RPM)	H152146	1	1001435	4014486459432
5	CLEANING FAN (490 - 980 RPM)	H152180	1	1001431	4014486459395
7	COUNTERSHAFT SECONDARY	H128010	1	1000797	4014486472165
8	CYLINDER INTERMEDIATE DRIVE BELT	H210476	1	1001543	4014486460636
9	CYLINDER DRIVE (240 - 960 RPM)	H115881	1	1003663	4014486490817
12	FEEDER HOUSE VARIABLE SPEED (STANDARD CAPACITY) (-700200)	H161648	1	No AP	
13	FIXED SPEED FEEDER HOUSE W/REVERSER (-700200)	H126345	1	1001124	4014486497106
13	FIXED SPEED FEEDER HOUSE W/REVERSER (700201-)	H156796	1	1004269	4014486683301
14	HEADER AND REEL PUMP (STANDARD)	H151952	1	1003570	4014486497014
15	LOWER TAILINGS AUGER & ELEVATOR	N110085	1	1000702	4014486470857
16	ROTARY SCREEN (-695000)	H145158	1	No AP	
16	ROTARY SCREEN (695201-)	H175632	1	1004469	4014486712117
17	SHOE, STRAW WALKER & CONVEYOR AUGERS	H131169	1	1001392	4014486475104
18	STRAW CHOPPER (STANDARD BALING)	H23950	1	1000682	4014486470581
19	STRAW SPREADER	H128234	1	1000419	4014486466829
20	UNLOADING SYSTEM	AH158880	2	1002861	4014486469400

### 9560 STS

1	CLEAN GRAIN ELEVATOR DRIVE	H218645	1	1001393	4014486475111
2	JACKSHAFT - RIGHT HAND (REAR)	H154723	1	1000738	4014486471335
3	JACKSHAFT - (FRONT) RIGHT HAND	AH202773	2	1002893	4014486469820
4	FEEDER ACCELERATOR - STANDARD SPEED (SERIAL NR. 715301 - ...)	H211581	1	1004059	4014486519815
4	FEEDER ACCELERATOR - STANDARD SPEED (SERIAL NR. ... - 715300)	H221731	1	1004197	4014486675504
4	FEEDER ACCELERATOR - LOW SPEED	H221732	1	1004130	4014486523126
5	SHOE FAN AND CONVEYOR AUGERS	H175587	1	1004166	4014486523003



## JOHN DEERE

6	CLEANING FAN DRIVE	H206048	1	1001426	4014486459340
6	CLEANING FAN - SLOW SPEED (SUB FOR H206049)	H211601	1	1001433	4014486459418
7	TAILINGS AUGER AND ELEVATOR	H154731	1	1000586	4014486469073
8	HEADER AND REEL PUMP (STANDARD CAPACITY)	H126345	1	1001124	4014486497106
8	HEADER AND REEL PUMP (HIGH CAPACITY)	H209507	1	1004136	4014486523621
9	FEEDER HOUSE FIXED SPEED	H126345	1	1001124	4014486497106
10	UNLOADING AUGER DRIVE	AH160080	2	1000681	4014486470550
11	ROTOR VARIATOR DRIVE	H169449	1	No AP	
12	DISCHARGE BEATER DRIVE	H168301	1	1000708	4014486470956
13	COUNTERSHAFT - DISCHARGE BEATER AND CHOPPER	H157514	1	1004131	4014486523133
14	STRAW CHOPPER DRIVE	H204747	1	1001656	4014486486100
15	FEEDER HOUSE VARIABLE DRIVE (STANDARD CAPACITY)	H201334	1	No AP	
15	FEEDER HOUSE VARIABLE DRIVE (HIGH CAPACITY)	H218726	1	No AP	
16	ROTARY SCREEN DRIVE - SCREEN SIDE	H175632	1	1004469	4014486712117
18	ALTERNATOR DRIVE (95 AMP)	R135606	1	1003191	4014486481846
18	ALTERNATOR DRIVE (185 AMP)	R135609	1	1003196	4014486481891

### 9570 STS

1	CLEAN GRAIN ELEVATOR DRIVE	H218645	1	1001393	4014486475111
2	JACKSHAFT - (FRONT) RIGHT HAND	AH202773	2	1002893	4014486469820
2	JACKSHAFT - RIGHT HAND (REAR)	H154723	1	1000738	4014486471335
3	FEEDER ACCELERATOR - LOW SPEED	H221732	1	1004130	4014486523126
3	FEEDER ACCELERATOR - STANDARD SPEED	H236472	1	1004059	4014486519815
4	SHOE FAN AND CONVEYOR AUGERS	H175587	1	1004166	4014486523003
5	CLEANING FAN DRIVE	H230909	1	1004058	4014486518337
6	TAILINGS AUGER AND ELEVATOR	H154731	1	1000586	4014486469073
7	HEADER AND REEL PUMP (STANDARD CAPACITY)	H126345	1	1001124	4014486497106
7	HEADER AND REEL PUMP (HIGH CAPACITY)	H209507	1	1004136	4014486523621
8	FEEDER HOUSE FIXED SPEED	H203474	1	1004057	4014486519914
9	UNLOADING AUGER DRIVE	AH160080	2	1000681	4014486470550
10	ROTOR VARIATOR DRIVE	H221498	1	No AP	
11	DISCHARGE BEATER DRIVE	H219182	1	1000708	4014486470956
12	COUNTERSHAFT - BEATER AND CHOPPER (STANDARD CAPACITY)	H157514	1	1004131	4014486523133
12	COUNTERSHAFT - BEATER AND CHOPPER (HIGH CAPACITY)	H201596	1	1001141	4014486519730
13	STRAW CHOPPER DRIVE	H204747	1	1001656	4014486486100
14	FEEDER HOUSE VARIABLE DRIVE (STANDARD CAPACITY)	H201334	1	No AP	
14	FEEDER HOUSE VARIABLE DRIVE (HIGH CAPACITY)	H218726	1	No AP	
15	ROTARY SCREEN DRIVE - ENGINE SIDE	H213353	1	1004109	4014486522846
15	ROTARY SCREEN DRIVE - SCREEN SIDE	H221273	1	1004112	4014486522877
16	ALTERNATOR DRIVE (200 AMP)	R521053	1	1004156	4014486523058

### 965 HYDRO 4

1	REEL DRIVE	Z20562	1	1000753	4014486471526
2	REEL DRIVE VARIABLE SPEED	Z20459	1	1003583	4014486459029
3	MAIN DRIVE	Z33790	1	1001995	4014486491180
4	UNLOADING SYSTEM	Z33368	1	1000603	4014486469370
5	HYDRAULIC PUMP DRIVE	Z34828	1	1003397	4014486462821
6	TRACTION DRIVE	AZ22914	2	1002915	4014486496918
8	STRAW ELEVATOR DRIVE	Z21500	1	1001103	4014486496857
10	RADIATOR FAN DRIVE	Z24833	1	No AP	
11	PURIFY DRIVE	Z31283	1	1000038	4014486460759
12	COUNTERSHAFT - PURIFY DRIVE	Z32190	1	1000002	4014486458985
13	CYLINDER DRIVE	Z20823	1	1003587	4014486460230
14	FAN DRIVE	Z34405	1	1000675	4014486470475
15	SICKLE KNIFE DRIVE	Z30130	1	1001111	4014486496949



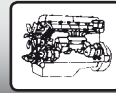
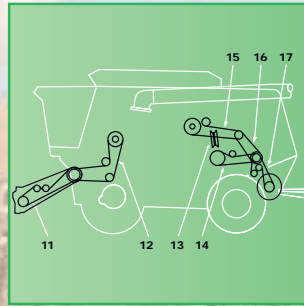
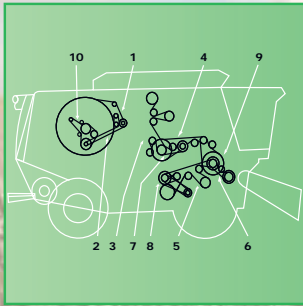

## JOHN DEERE

### 9650 CTS

1	ALTERNATOR (95 AMP) (-695400)	H163515	1	1003209	4014486482256
1	ALTERNATOR (185 AMP) (-695400)	H166870	1	1004090	4014486520521
2	COUNTERSHAFT SECONDARY	H128010	1	1000797	4014486472165
2	CONVEYOR AUGER, SIEVE, AND CHAFFER	H131169	1	1001392	4014486475104
2		H165708	1	1001579	4014486484861
2	ALTERNATOR (185 AMP) (695401-)	R164820	1	1003114	4014486480641
3	COOLING FAN (695401-)	H177186	1	1003223	4014486482508
4	ROTARY SCREEN (-695400)	H145158	1	No AP	
5	ROTARY SCREEN (695401-)	H175632	1	1004469	4014486712117
6	CLEAN GRAIN ELEVATOR	H141166	1	1001394	4014486475128
6	ROTARY SCREEN DRIVE (695401-)	H146636	1	1004193	4014486558487
7	CYLINDER INTERMEDIATE DRIVE (2290 E.L.)	H210476	1	1001543	4014486460636
9	CYLINDER DRIVE (2830E.L.)	H115881	1	1003663	4014486490817
10	HEADER AND REEL PUMP (STANDARD CAPACITY)	H151952	1	1003570	4014486497014
10	HEADER AND REEL PUMP (HIGH CAPACITY)	H155998	1	1000764	4014486471670
10	LOWER TAILINGS AUGER & ELEVATOR	N110085	1	1000702	4014486470857
12	CLEANING FAN (750 - 1350 RPM)	H152146	1	1001435	4014486459432
12	CLEANING FAN (490 - 980 RPM)	H152180	1	1001431	4014486459395
13	FIXED SPEED FEEDER HOUSE W/REVERSER (-700400_	H126345	1	1001124	4014486497106
13	FIXED SPEED FEEDER HOUSE W/REVERSER (700401-)	H156796	1	1004269	4014486683301
15	FEEDER HOUSE VARIABLE SPEED (STANDARD CAPACITY) (-700400)	H161648	1	No AP	
17	OVERSHOT BEATER DRIVE	H139963	1	1000221	4014486462852
17	OVERSHOT BEATER DRIVE (740-1170 RPM)	H165708	1	1001579	4014486484861
18	STRIPPER BEATER DRIVE	H165708	1	1001579	4014486484861
19	UNLOADING SYSTEM	AH158880	2	1002861	4014486469400

### 9650 STS

1	ROTARY SCREEN DRIVE	H206807	1	1002435	4014486493139
2	ROTARY SCREEN DRIVE	H157104	1	1002437	4014486493153
3	ELEVATOR DRIVE GRAIN	H158512	1	1000853	4014486472844
4	JACKSHAFT - RIGHT HAND (REAR)	H154723	1	1000738	4014486471335
5	SHOE FAN AND CONVEYOR AUGERS	H175587	1	1004166	4014486523003
7	TAILINGS AUGER AND ELEVATOR	H154731	1	1000586	4014486469073
8	CLEANING FAN DRIVE	H165072	1	1001425	4014486459326
9	JACKSHAFT RIGHT HAND	AH150678	2	1002892	4014486470192
10	ALTERNATOR DRIVE 95 AMP	R135606	1	1003191	4014486481846
12	HEADER AND REEL PUMP	H156541	1	1001785	4014486519662
13	STS VARIABLE DRIVE	H165545	1	No AP	
14	DISCHARGE BEATER DRIVE	H168301	1	1000708	4014486470956
15	UNLOADING AUGER DRIVE	AH160080	2	1000681	4014486470550
16	COUNTERSHAFT - BEATER AND CHOPPER	H157514	1	1004131	4014486523133
17	STRAW CHOPPER DRIVE	H204747	1	1001656	4014486486100

### 9660 STS

1	CLEAN GRAIN ELEVATOR	H218645	1	1001393	4014486475111
1	CLEAN GRAIN ELEVATOR DRIVE	H218645	1	1001393	4014486475111
2	R.H. JACKSHAFT, FRONT	AH150678	2	1002892	4014486470192
2	JACKSHAFT - RIGHT HAND (REAR)	H154723	1	1000738	4014486471335
2	R.H. JACKSHAFT, REAR	H154723	1	1000738	4014486471335
3	JACKSHAFT - (FRONT) RIGHT HAND	AH150678	2	1002892	4014486470192
3	FEED ACCELERATOR, STANDARD SPEED -715400	H221731	1	1004197	4014486675504
3	FEED ACCELERATOR, SLOW SPEED	H221732	1	1004130	4014486523126
3	FEED ACCELERATOR, STANDARD SPEED 715401-	H236472	1	1004059	4014486519815



## JOHN DEERE

4	SHOE FAN AND CONVEYOR AUGERS	H175587	1	1004166	4014486523003
4	FEEDER ACCELERATOR - STANDARD SPEED (SERIAL NR. 715301 - ...)	H211581	1	1004059	4014486519815
4	FEEDER ACCELERATOR - STANDARD SPEED (SERIAL NR. ... - 715300)	H221731	1	1004197	4014486675504
4	FEEDER ACCELERATOR - LOW SPEED	H221732	1	1004130	4014486523126
5		H175587	1	1004166	4014486523003
5	CLEANING FAN	H206048	1	1001426	4014486459340
5	CLEANING FAN, SLOW SPEED	H211601	1	1001433	4014486459418
6	TAILINGS AUGER AND ELEVATOR	H154731	1	1000586	4014486469073
6	CLEANING FAN DRIVE	H206048	1	1001426	4014486459340
6	CLEANING FAN - SLOW SPEED	H211601	1	1001433	4014486459418
7		H154731	1	1000586	4014486469073
7	HEADER AND REEL PUMP, HIGH CAPACITY	H156541	1	1001785	4014486519662
7	HEADER AND REEL PUMP, STANDARD CAPACITY	H156796	1	1004269	4014486683301
8	UNLOADING AUGER SYSTEM	AH160080	2	1000681	4014486470550
8	HEADER AND REEL PUMP (HIGH CAPACITY)	H156541	1	1001785	4014486519662
8	HEADER AND REEL PUMP (STANDARD CAPACITY)	H156796	1	1004269	4014486683301
9	FEEDER HOUSE FIXED SPEED	H203474	1	1004057	4014486519914
9	VARIABLE ROTOR DRIVE	H221498	1	No AP	
10	UNLOADING AUGER DRIVE	AH160080	2	1000681	4014486470550
10	DISCHARGE BEATER	H219182	1	1000708	4014486470956
11	ROTOR VARIATOR DRIVE	H169449	1	No AP	
12	DISCHARGE BEATER DRIVE	H168301	1	1000708	4014486470956
12	STRAW CHOPPER	H235564	1	1001656	4014486486100
13	COUNTERSHAFT - DISCHARGE BEATER AND CHOPPER	H157514	1	1004131	4014486523133
13	VARIABLE DRIVE FEEDER HOUSE, STANDARD CAPACITY	H201334	1	No AP	
13	VARIABLE DRIVE FEEDER HOUSE, HIGH CAPACITY	H218726	1	No AP	
13	VARIABLE DRIVE FEEDER HOUSE, HIGH CAPACITY (HIGH TORQUE)	H220911	1	No AP	
14	FIXED SPEED FEEDER HOUSE	H203474	1	1004057	4014486519914
14	STRAW CHOPPER DRIVE	H204747	1	1001656	4014486486100
15	ROTARY SCREEN DRIVE, SCREEN SIDE -715400	H175628	1	1000180	4014486462098
15	FEEDER HOUSE VARIABLE DRIVE (STANDARD CAPACITY)	H201334	1	No AP	
15	ROTARY SCREEN DRIVE, ENGINE SIDE -715400	H206807	1	1002435	4014486493139
15	ROTARY SCREEN DRIVE, ENGINE SIDE 715401-	H213353	1	1004109	4014486522846
15	FEEDER HOUSE VARIABLE DRIVE (HIGH CAPACITY)	H218726	1	No AP	
16	ALTERNATOR, 200 AMP	AT262958	1	1003226	4014486482560
16	ROTARY SCREEN DRIVE - SCREEN SIDE	H175632	1	1004469	4014486712117
16	ALTERNATOR, 95 AMP	R135606	1	1003191	4014486481846
16	ALTERNATOR, 185 AMP	R135609	1	1003196	4014486481891
17	ROTARY SCREEN DRIVE - ENGINE SIDE	H206807	1	1002435	4014486493139
18	ALTERNATOR DRIVE (95 AMP)	R135606	1	1003191	4014486481846
18	ALTERNATOR DRIVE (185 AMP)	R135609	1	1003196	4014486481891

### 9670 STS

1	CLEAN GRAIN ELEVATOR	H218645	1	1001393	4014486475111
1	CLEAN GRAIN ELEVATOR DRIVE	H218645	1	1001393	4014486475111
2	JACKSHAFT - (FRONT) RIGHT HAND	AH150678	2	1002892	4014486470192
2	R.H. JACKSHAFT, FRONT	AH150678	2	1002892	4014486470192
2	JACKSHAFT - RIGHT HAND (REAR)	H154723	1	1000738	4014486471335
2	R.H. JACKSHAFT, REAR	H154723	1	1000738	4014486471335
3	SHOE FAN AND CONVEYOR AUGERS	H175587	1	1004166	4014486523003
3	FEED ACCELERATOR, SLOW SPEED	H221732	1	1004130	4014486523126
3	FEEDER ACCELERATOR - LOW SPEED	H221732	1	1004130	4014486523126
3	FEED ACCELERATOR, STANDARD SPEED	H236472	1	1004059	4014486519815
3	FEEDER ACCELERATOR - STANDARD SPEED	H236472	1	1004059	4014486519815
4		H175587	1	1004166	4014486523003

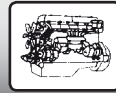
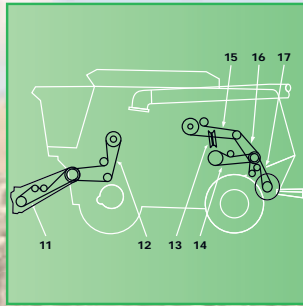
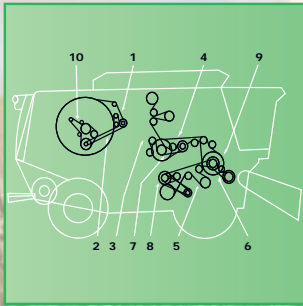

## JOHN DEERE

4	CLEANING FAN	H206048	1	1001426	4014486459340
5	TAILINGS AUGER AND ELEVATOR	H154731	1	1000586	4014486469073
5	CLEANING FAN DRIVE	H206048	1	1001426	4014486459340
6		H154731	1	1000586	4014486469073
6	HEADER AND REEL PUMP (FIXED SPEED)	H156796	1	1004269	4014486683301
7	HEADER AND REEL PUMP (VARIABLE CAPACITY)	H156541	1	1001785	4014486519662
7	HEADER AND REEL PUMP (VARIABLE SPEED)	H156541	1	1001785	4014486519662
7	HEADER AND REEL PUMP (FIXED CAPACITY)	H156796	1	1004269	4014486683301
7	HEADER AND REEL (MULTI SPEED FEEDER HOUSE DRIVE)	H229018	1	1004145	4014486523652
8	UNLOADING AUGER SYSTEM	AH160080	2	1000681	4014486470550
8	FEEDER HOUSE FIXED SPEED	H203474	1	1004057	4014486519914
8	FEEDER HOUSE FIXED SPEED (EXTRA HEAVY DUTY)	H229019	1	1004144	4014486523645
9	UNLOADING AUGER DRIVE	AH160080	2	1000681	4014486470550
9	VARIABLE ROTOR DRIVE	H221498	1	No AP	
10	DISCHARGE BEATER	H219182	1	1000708	4014486470956
10	ROTOR VARIATOR DRIVE	H221498	1	No AP	
11	DISCHARGE BEATER DRIVE	H168301	1	1000708	4014486470956
12	COUNTERSHAFT - BEATER AND CHOPPER (STANDARD CAPACITY)	H157514	1	1004131	4014486523133
12	COUNTERSHAFT - BEATER AND CHOPPER (HIGH CAPACITY)	H223384	1	1004142	4014486523225
12	COUNTERSHAFT, DISCHARGE BEATER AND CHOPPER (REGULAR)	HXE10556	1	1004133	4014486523157
13	STRAW CHOPPER (CIS)	H204747	1	1001656	4014486486100
13	STRAW CHOPPER	H232997	1	1001606	4014486485325
13	STRAW CHOPPER DRIVE	H232997	1	1001606	4014486485325
13	STRAW CHOPPER (CIS)	H235564	1	1001656	4014486486100
13	COUNTERSHAFT, DISCHARGE BEATER AND CHOPPER (HEAVY DUTY)	HXE10501	1	1004142	4014486523225
14	FEEDER HOUSE VARIABLE DRIVE	H218726	1	No AP	
14	VARIABLE SPEED FEEDER HOUSE DRIVE	H218726	1	No AP	
14	FEEDER HOUSE VARIABLE DRIVE (EXTRA HEAVY DUTY)	H220911	1	No AP	
15	FIXED SPEED FEEDER HOUSE	H203474	1	1004057	4014486519914
15	ROTARY SCREEN DRIVE - ENGINE SIDE	H213353	1	1004109	4014486522846
15	VARIABLE SPEED FEEDER HOUSE DRIVE (HIGH SPEED)	H220911	1	No AP	
15	ROTARY SCREEN DRIVE - SCREEN SIDE	H221273	1	1004112	4014486522877
15	ROTARY SCREEN DRIVE, SCREEN SIDE	H221273	1	1004112	4014486522877
15	FIXED SPEED FEEDER HOUSE (MULTI SPEED FEEDER HOUSE DRIVE)	H229019	1	1004144	4014486523645
16	ALTERNATOR DRIVE (200 AMP)	AT262958	1	1003226	4014486482560
16	ALTERNATOR, 200 AMP	AT262958	1	1003226	4014486482560
16	ROTARY SCREEN DRIVE, ENGINE SIDE	H213353	1	1004109	4014486522846

### 9750 STS

1	ROTARY SCREEN DRIVE	H206807	1	1002435	4014486493139
2	ROTARY SCREEN DRIVE	H157104	1	1002437	4014486493153
3	ELEVATOR DRIVE GRAIN	H158512	1	1000853	4014486472844
4	JACKSHAFT - RIGHT HAND (REAR)	H154723	1	1000738	4014486471335
5	SHOE FAN AND CONVEYOR AUGERS	H175587	1	1004166	4014486523003
7	TAILINGS AUGER AND ELEVATOR	H154731	1	1000586	4014486469073
8	CLEANING FAN DRIVE	H165072	1	1001425	4014486459326
9	JACKSHAFT RIGHT HAND	AH150678	2	1002892	4014486470192
10	ALTERNATOR DRIVE 95 AMP	R135606	1	1003191	4014486481846
12	HEADER AND REEL PUMP	H156541	1	1001785	4014486519662
13	STS VARIABLE DRIVE	H165545	1	No AP	
14	DISCHARGE BEATER DRIVE	H168301	1	1000708	4014486470956
15	UNLOADING AUGER DRIVE	AH160080	2	1000681	4014486470550
16	COUNTERSHAFT - BEATER AND CHOPPER	H157514	1	1004131	4014486523133
17	STRAW CHOPPER DRIVE	H204747	1	1001656	4014486486100



## JOHN DEERE

### 9760 STS

1	CLEAN GRAIN ELEVATOR DRIVE	H218645	1	1001393	4014486475111
2	JACKSHAFT - RIGHT HAND (REAR)	H154723	1	1000738	4014486471335
3	JACKSHAFT - (FRONT) RIGHT HAND	AH150678	2	1002892	4014486470192
4	FEEDER ACCELERATOR - STANDARD SPEED (SERIAL NR. 715301 - ...)	H211581	1	1004059	4014486519815
4	FEEDER ACCELERATOR - STANDARD SPEED (SERIAL NR. ... - 715301)	H221731	1	1004197	4014486675504
4	FEEDER ACCELERATOR - LOW SPEED	H221732	1	1004130	4014486523126
5	SHOE FAN AND CONVEYOR AUGERS	H175587	1	1004166	4014486523003
6	CLEANING FAN DRIVE	H206048	1	1001426	4014486459340
6	CLEANING FAN - SLOW SPEED	H211601	1	1001433	4014486459418
7	TAILINGS AUGER AND ELEVATOR	H154731	1	1000586	4014486469073
8	HEADER AND REEL PUMP (HIGH CAPACITY)	H156541	1	1001785	4014486519662
8	HEADER AND REEL PUMP (STANDARD CAPACITY)	H156796	1	1004269	4014486683301
9	FEEDER HOUSE FIXED SPEED	H203474	1	1004057	4014486519914
10	UNLOADING AUGER DRIVE	AH160080	2	1000681	4014486470550
11	ROTOR VARIATOR DRIVE	H169449	1	No AP	
12	DISCHARGE BEATER DRIVE	H168301	1	1000708	4014486470956
13	COUNTERSHAFT - DISCHARGE BEATER AND CHOPPER	H157514	1	1004131	4014486523133
14	STRAW CHOPPER DRIVE	H204747	1	1001656	4014486486100
15	FEEDER HOUSE VARIABLE DRIVE (HIGH CAPACITY)	H218726	1	No AP	
16	ROTARY SCREEN DRIVE - SCREEN SIDE	H175632	1	1004469	4014486712117
17	ROTARY SCREEN DRIVE - ENGINE SIDE	H206807	1	1002435	4014486493139
18	ALTERNATOR DRIVE (95 AMP)	R135606	1	1003191	4014486481846
18	ALTERNATOR DRIVE (185 AMP)	R135609	1	1003196	4014486481891

### 9770 STS

1	CLEAN GRAIN ELEVATOR DRIVE	H218645	1	1001393	4014486475111
2	JACKSHAFT - (FRONT) RIGHT HAND	AH150678	2	1002892	4014486470192
2	JACKSHAFT - RIGHT HAND (REAR)	H154723	1	1000738	4014486471335
3	FEEDER ACCELERATOR - LOW SPEED	H221732	1	1004130	4014486523126
3	FEEDER ACCELERATOR - STANDARD SPEED	H236472	1	1004059	4014486519815
4	SHOE FAN AND CONVEYOR AUGERS	H175587	1	1004166	4014486523003
5	CLEANING FAN DRIVE	H206048	1	1001426	4014486459340
6	TAILINGS AUGER AND ELEVATOR	H154731	1	1000586	4014486469073
7	HEADER AND REEL PUMP (VARIABLE CAPACITY)	H156541	1	1001785	4014486519662
7	HEADER AND REEL PUMP (FIXED CAPACITY)	H156796	1	1004269	4014486683301
7	HEADER AND REEL PUMP (MULTI SPEED FEEDER HOUSE DRIVE)	H229018	1	1004145	4014486523652
8	FEEDER HOUSE FIXED SPEED	H203474	1	1004057	4014486519914
8	FEEDER HOUSE VARIABLE DRIVE	H229019	1	1004144	4014486523645
9	UNLOADING AUGER DRIVE	AH160080	2	1000681	4014486470550
10	ROTOR VARIATOR DRIVE	H208431	1	No AP	
11	DISCHARGE BEATER DRIVE	H168301	1	1000708	4014486470956
12	COUNTERSHAFT - BEATER AND CHOPPER (STANDARD CAPACITY)	H157514	1	1004131	4014486523133
12	COUNTERSHAFT - BEATER AND CHOPPER (HIGH CAPACITY)	H223384	1	1004142	4014486523225
13	STRAW CHOPPER (CIS)	H204747	1	1001656	4014486486100
13	STRAW CHOPPER DRIVE	H223212	1	1004134	4014486523164
14	FEEDER HOUSE VARIABLE DRIVE	H218726	1	No AP	
14	FEEDER HOUSE VARIABLE DRIVE (HIGH SPEED)	H220911	1	No AP	
15	ROTARY SCREEN DRIVE - ENGINE SIDE	H213353	1	1004109	4014486522846
15	ROTARY SCREEN DRIVE - SCREEN SIDE	H221273	1	1004112	4014486522877
16	ALTERNATOR DRIVE (200 AMP)	AT262958	1	1003226	4014486482560

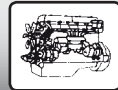

## JOHN DEERE

### 9860 STS

1	HEADER AND REEL PUMP (HIGH CAPACITY)	H156541	1	1001785	4014486519662
1	HEADER AND REEL PUMP (STANDARD CAPACITY)	H156796	1	1004269	4014486683301
2	FEEDER HOUSE FIXED SPEED (EXTRA HEAVY DUTY)	H174885	1	1001777	4014486519631
2	FEEDER HOUSE VARIABLE DRIVE	H203474	1	1004057	4014486519914
3	UNLOADING AUGER DRIVE	AH160080	2	1000681	4014486470550
4	VARIATOR ROTOR DRIVE (SERIAL NR. ...705797)	H207851	1	No AP	
4	VARIATOR ROTOR DRIVE (SERIAL NR. 705798..)	H208431	1	No AP	
5	DISCHARGE BEATER DRIVE	H168301	1	1000708	4014486470956
6	COUNTERSHAFT - DISCHARGE BEATER AND CHOPPER	H201596	1	1001141	4014486519730
7	STRAW CHOPPER DRIVE	H217352	1	1001772	4014486519617
8	FEEDER HOUSE VARIABLE DRIVE	H218726	1	No AP	
9	CLEAN GRAIN ELEVATOR DRIVE	H218645	1	1001393	4014486475111
10	JACKSHAFT - RIGHT HAND (REAR)	H154723	1	1000738	4014486471335
11	JACKSHAFT - (FRONT) RIGHT HAND	AH150678	2	1002892	4014486470192
12	FEEDER ACCELERATOR - STANDARD SPEED (SERIAL NR. 715301..)	H211581	1	1004059	4014486519815
12	FEEDER ACCELERATOR - STANDARD SPEED (SERIAL NR. ...715300)	H221731	1	1004197	4014486675504
12	FEEDER ACCELERATOR - LOW SPEED	H221732	1	1004130	4014486523126
13	CLEANING FAN DRIVE	H206048	1	1001426	4014486459340
13	CLEANING FAN - SLOW SPEED	H211601	1	1001433	4014486459418
14	TAILINGS AUGER AND ELEVATOR	H154731	1	1000586	4014486469073

### 9870 STS

1	CLEAN GRAIN ELEVATOR DRIVE	H223230	1	1004137	4014486523416
2	JACKSHAFT - (FRONT) RIGHT HAND	AH150678	2	1002892	4014486470192
2	JACKSHAFT - RIGHT HAND (REAR)	H154723	1	1000738	4014486471335
3	FEEDER ACCELERATOR - LOW SPEED	H221732	1	1004130	4014486523126
3	FEEDER ACCELERATOR - HIGH SPEED (SERIAL NR. 730101..)	H230230	1	1004138	4014486523263
3	FEEDER ACCELERATOR - STANDARD SPEED	H236472	1	1004059	4014486519815
4	SHOE FAN AND CONVEYOR AUGERS	H175587	1	1004166	4014486523003
5	CLEANING FAN DRIVE	H230909	1	1004058	4014486518337
6	TAILINGS AUGER AND ELEVATOR	H154731	1	1000586	4014486469073
7	HEADER AND REEL PUMP	H156541	1	1001785	4014486519662
7	HEADER AND REEL PUMP (MULTI SPEED FEEDER HOUSE DRIVE)	H229018	1	1004145	4014486523652
8	FEEDER HOUSE FIXED SPEED (EXTRA HEAVY DUTY)	H174885	1	1001777	4014486519631
8	FEEDER HOUSE VARIABLE DRIVE	H229019	1	1004144	4014486523645
9	UNLOADING AUGER DRIVE	AH160080	2	1000681	4014486470550
10	ROTOR VARIATOR DRIVE	H208431	1	No AP	
11	DISCHARGE BEATER DRIVE (CIS)	H168301	1	1000708	4014486470956
11	DISCHARGE BEATER DRIVE	H219182	1	1000708	4014486470956
12	COUNTERSHAFT - BEATER AND CHOPPER (CIS)	H157514	1	1004131	4014486523133
12	COUNTERSHAFT - BEATER AND CHOPPER (HEAVY DUTY)	H223384	1	1004142	4014486523225
12	COUNTERSHAFT - BEATER AND CHOPPER (STANDARD CAPACITY)	H223385	1	1004133	4014486523157
13	STRAW CHOPPER (CIS)	H204747	1	1001656	4014486486100
13	STRAW CHOPPER DRIVE	H223212	1	1004134	4014486523164
14	ROTARY SCREEN DRIVE - ENGINE SIDE	H213353	1	1004109	4014486522846
14	ROTARY SCREEN DRIVE - SCREEN SIDE	H221273	1	1004112	4014486522877
15	ALTERNATOR DRIVE	R503505	1	1003207	4014486482171
16	ENGINE FAN DRIVE	R503312	1	1002614	4014486484182



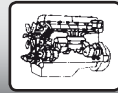
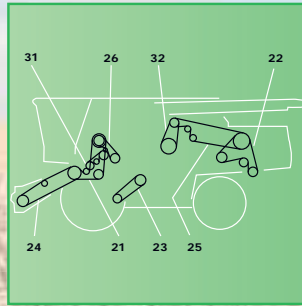
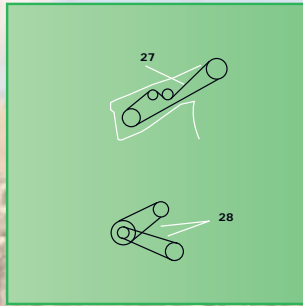
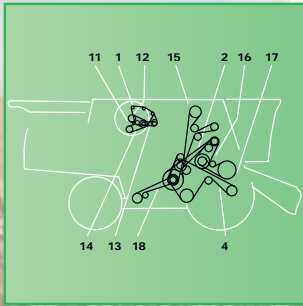

# JOHN DEERE

CTS 2					
1	ALTERNATOR DRIVE	H163515	1	1003209	4014486482256
2	COUNTERSHAFT (SECONDARY)	H128010	1	1000797	4014486472165
4	STRAW WALKER - CONVEYOR AUGERS	H131169	1	1001392	4014486475104
6		H145158	1	No AP	
8	AIR CONDITIONING COMPRESSOR DRIVE	H134437	1	No AP	
10	CYLINDER DRIVE INTERMEDIATE	H162629	1	1001543	4014486460636
11	CYLINDER DRIVE	H115881	1	1003663	4014486490817
13	STRIPPER BEATER	H139963	1	1000221	4014486462852
14	UNLOADING SYSTEM	AH127866	2	1003765	4014486469394
15	EQUIPMENT FRONT END	H151952	1	1003570	4014486497014
16	STRAW CHOPPER (FRONT)	H162541	1	1001774	4014486519624
17	FAN DRIVE REGULAR (N=750-1350 RPM)	H152146	1	1001435	4014486459432
17	SLOW SPEED (N=490-980 RPM) OPTIONAL	H152180	1	1001431	4014486459395
18	DRUM DRIVE VARIABLE SPEED	H161648	1	No AP	
19	SEPARATOR DRIVE	H141429	1	1001149	4014486519792
21	FEEDER HOUSE FIXED SPEED	H126345	1	1001124	4014486497106
S 690					
1		H218645	1	1001393	4014486475111
2		H154723	1	1000738	4014486471335
3		AH150678	2	1002892	4014486470192
4	SLOW SPEED	H221732	1	1004130	4014486523126
5		H175587	1	1004166	4014486523003
6		H230909	1	1004058	4014486518337
8		H154731	1	1000586	4014486469073
9		H156541	1	1001785	4014486519662
9		H229018	1	1004145	4014486523652
11		AH160080	2	1000681	4014486470550
12		H208431	1	No AP	
13		H219182	1	1000708	4014486470956
14		H228347	1	1004149	4014486523669
15		H228346	1	1004143	4014486523638
16		H174885	1	1001777	4014486519631
16		H229019	1	1004144	4014486523645
T 550					
1		H175628	1	1000180	4014486462098
2		H174455	1	1003217	4014486482454
3		H146636	1	1004193	4014486558487
4		Z59557	1	1001388	4014486475043
5		H141166	1	1001394	4014486475128
6		H128010	1	1000797	4014486472165
7		H115881	1	1003663	4014486490817
8		H176766	1	1001756	4014486519556
8	FOR HILLMASTER ONLY	H202821	1	1001759	4014486519563
9		Z103844	1	1001815	4014486488302
10	FOR N=450 RPM - 3 GROOVES	Z103844	1	1001815	4014486488302
10	FOR N=900 RPM - 2 GROOVES	Z103845	1	1001571	4014486484748
11		H139963	1	1000221	4014486462852
12	HEAVY DUTY VERSION	H176765	1	1001789	4014486519686
12		H177383	1	1001128	4014486497144
13		H152146	1	1001435	4014486459432
14		AH158880	2	1002861	4014486469400



## JOHN DEERE

15		H177177	1	1001905	4014486489668
16	FOR CORN	H177178	1	1001913	4014486489767
17		Z59286	1	1001911	4014486489736

### T 560

1		H175628	1	1000180	4014486462098
2		H174455	1	1003217	4014486482454
3		H146636	1	1004193	4014486558487
4		Z59557	1	1001388	4014486475043
5		H141166	1	1001394	4014486475128
6		H128010	1	1000797	4014486472165
7		H115881	1	1003663	4014486490817
8		H176766	1	1001756	4014486519556
8	FOR HILLMASTER ONLY	H202821	1	1001759	4014486519563
9		Z103844	1	1001815	4014486488302
10	FOR N=450 RPM - 3 GROOVES	Z103844	1	1001815	4014486488302
10	FOR N=900 RPM - 2 GROOVES	Z103845	1	1001571	4014486484748
11		H139963	1	1000221	4014486462852
12	HEAVY DUTY VERSION	H176765	1	1001789	4014486519686
12		H177383	1	1001128	4014486497144
13		H152146	1	1001435	4014486459432
14		AH158880	2	1002861	4014486469400
15		H177177	1	1001905	4014486489668
16	FOR CORN	H177178	1	1001913	4014486489767
17		Z59286	1	1001911	4014486489736

### T 660

1		H175628	1	1000180	4014486462098
2		H174455	1	1003217	4014486482454
3		H146636	1	1004193	4014486558487
4		Z59557	1	1001388	4014486475043
5		H141166	1	1001394	4014486475128
6		H128010	1	1000797	4014486472165
7		H115881	1	1003663	4014486490817
8		H176766	1	1001756	4014486519556
8	FOR HILLMASTER ONLY	H202821	1	1001759	4014486519563
9		Z103844	1	1001815	4014486488302
10	FOR N=450 RPM - 3 GROOVES	Z103844	1	1001815	4014486488302
10	FOR N=900 RPM - 2 GROOVES	Z103845	1	1001571	4014486484748
11		H139963	1	1000221	4014486462852
12		H176765	1	1001789	4014486519686
13		H152146	1	1001435	4014486459432
14		AH158880	2	1002861	4014486469400
15		H177177	1	1001905	4014486489668
16	FOR CORN	H177178	1	1001913	4014486489767
17		Z59286	1	1001911	4014486489736

### T 670

1		H175628	1	1000180	4014486462098
2		H174455	1	1003217	4014486482454
3		H146636	1	1004193	4014486558487
4		Z59557	1	1001388	4014486475043
5		H141166	1	1001394	4014486475128
6		H128010	1	1000797	4014486472165
7		H115881	1	1003663	4014486490817







## JOHN DEERE – TURF N CARE

<b>737 Z-Trak AC Gas Engine W/54"</b>					
	MOWER DECK	TCU12829	1	1003102	4014486480337
<b>737 Z-Trak AC Gas Engine W/54IN</b>					
	MOWER DECK	TCU16026	1	1003104	4014486519303
<b>737 Z-Trak AC Gas Engine W/60"</b>					
	MOWER DECK	TCU12829	1	1003102	4014486480337
<b>737 Z-Trak AC Gas Engine W/60IN</b>					
	MOWER DECK	TCU16026	1	1003104	4014486519303
<b>757 Z-Trak AC Gas Engine W/54</b>					
	Mower Deck	TCU12829	1	1003102	4014486480337
<b>757 Z-Trak AC Gas Engine W/54IN</b>					
	Mower Deck	TCU16026	1	1003104	4014486519303
<b>757 Z-Trak AC Gas Engine W/60</b>					
	Mower Deck	TCU12829	1	1003102	4014486480337
<b>757 Z-Trak AC Gas Engine W/60IN</b>					
	Mower Deck	TCU16026	1	1003104	4014486519303
<b>777 Z-TRAK</b>					
	MOWER DECK	TCU16841	1	1003107	4014486519310
	MOWER DECK	TCU16841	1	1003107	4014486519310
	MULCH ON DEMAND DECK	TCU16841	1	1003107	4014486519310
<b>777 Z-TRAK W/60IN</b>					
	MOWER DECK	TCU16026	1	1003104	4014486519303
	MULCH ON DEMAND DECK	TCU16026	1	1003104	4014486519303
<b>777 Z-TRAK W/72IN</b>					
	MOWER DECK	TCU16026	1	1003104	4014486519303
<b>797 Z-TRAK</b>					
	MOWER DECK	TCU16841	1	1003107	4014486519310
	MOWER DECK	TCU16841	1	1003107	4014486519310
<b>797 Z-TRAK W/60IN</b>					
	MOWER DECK	TCU16026	1	1003104	4014486519303
<b>797 Z-TRAK W/72IN</b>					
	MOWER DECK	TCU16026	1	1003104	4014486519303
<b>MCS SYSTEM FOR Z-TRAK</b>					
	(14 BUSHEL)	TCU16841	1	1003107	4014486519310
	(14 BUSHEL)	TCU16841	1	1003107	4014486519310
<b>MCS System For Z-Trak</b>					
		TCU16026	1	1003104	4014486519303
	(14 BUSHEL)	TCU16026	1	1003104	4014486519303
	(14 BUSHEL)	TCU16026	1	1003104	4014486519303

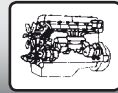

## JOHN DEERE – TURF N CARE

### MCS System for ZTrak W/54"

DECK (14 Bushel)	TCU12829	1	1003102	4014486480337
------------------	----------	---	---------	---------------

### MCS System For Z-Trak W/54"

DECK (14 Bushel)	TCU12829	1	1003102	4014486480337
DECK (8 Bushel)	TCU12829	1	1003102	4014486480337

### MCS System for ZTrak W/54IN

DECK (14 Bushel)	TCU16026	1	1003104	4014486519303
------------------	----------	---	---------	---------------

### MCS System For Z-Trak W/54IN

DECK (14 Bushel)	TCU16026	1	1003104	4014486519303
DECK (8 Bushel)	TCU16026	1	1003104	4014486519303

### MCS System for Ztrak W/60"

DECK (14 Bushel)	TCU12829	1	1003102	4014486480337
------------------	----------	---	---------	---------------

### MCS System For Z-Trak W/60"

DECK (14 Bushel)	TCU12829	1	1003102	4014486480337
DECK (8 Bushel)	TCU12829	1	1003102	4014486480337
DECK (8 Bushel)	TCU12829	1	1003102	4014486480337

### MCS System for Ztrak W/60IN

DECK (14 Bushel)	TCU16026	1	1003104	4014486519303
------------------	----------	---	---------	---------------

### MCS System For Z-Trak W/60IN

MOWER DECK	TCU12829	1	1003102	4014486480337
DECK (14 Bushel)	TCU16026	1	1003104	4014486519303
DECK (8 Bushel)	TCU16026	1	1003104	4014486519303
DECK (8 Bushel)	TCU16026	1	1003104	4014486519303

### Mulch On Demand Deck Option for ZTrak W/60IN

DECK	TCU16026	1	1003104	4014486519303
------	----------	---	---------	---------------

### Mulch On Demand Deck Option For Z-Trak W/60IN

DECK	TCU16026	1	1003104	4014486519303
------	----------	---	---------	---------------

### Mulch On Demand Deck W/60"

DECK	TCU12829	1	1003102	4014486480337
DECK	TCU12829	1	1003102	4014486480337

### V-FLEX 7-IRON

MOWER DECK (FOR 1400 & 1500 SERIES FRONT MOWERS)	TCU13749	1	1003103	4014486480306
--	----------	---	---------	---------------

### Z710A Z-Trak Series Mower

MOWER DECK	TCU29452	1	1004778	4014486716894
MOWER DECK	TCU29452	1	1004778	4014486716894
MOWER DECK	TCU29453	1	1004781	4014486716924
MOWER DECK	TCU29453	1	1004781	4014486716924

### Z720A Z-Trak Series W/60IN

MOWER DECK	TCU29454	1	1004784	4014486716955
------------	----------	---	---------	---------------



## JOHN DEERE – TURF N CARE

### Z910A Z-Trak Pro Series Mower

MOWER DECK	TCU29452	1	1004778	4014486716894
MOWER DECK	TCU29452	1	1004778	4014486716894
MOWER DECK	TCU29453	1	1004781	4014486716924
MOWER DECK	TCU29453	1	1004781	4014486716924

### Z915B W/48IN

MOWER DECK	TCU30510	1	1004779	4014486716900
MOWER DECK DRIVE	TCU31132	1	1004775	4014486716863
MOWER DECK DRIVE	TCU31132	1	1004782	4014486716931

### Z915B W/54IN

MOWER DECK	TCU30510	1	1004779	4014486716900
MOWER DECK DRIVE	TCU31132	1	1004775	4014486716863
MOWER DECK DRIVE	TCU31132	1	1004782	4014486716931

### Z920A Z-Trak Pro Series Mower

MOD MOWER DECK	TCU29452	1	1004778	4014486716894
MOWER DECK	TCU29452	1	1004778	4014486716894
MOWER DECK	TCU29452	1	1004778	4014486716894
MOWER DECK	TCU29452	1	1004778	4014486716894
MOD MOWER DECK	TCU29453	1	1004781	4014486716924
MOWER DECK	TCU29453	1	1004781	4014486716924
MOWER DECK	TCU29453	1	1004781	4014486716924
MOWER DECK	TCU29453	1	1004781	4014486716924

### Z920A Z-Trak Pro Mower W/48IN

MOD MOWER DECK	TCU29454	1	1004784	4014486716955
MOWER DECK	TCU29454	1	1004784	4014486716955

### Z920A Z-Trak Pro Mower W/54IN

MOWER DECK	TCU29454	1	1004784	4014486716955
------------	----------	---	---------	---------------

### Z920A Z-Trak Pro Mower W/60IN

MOWER DECK	TCU29454	1	1004784	4014486716955
------------	----------	---	---------	---------------

### Z920M W/48IN

MOWER DECK	TCU30356	1	1004785	4014486716962
MOWER DECK	TCU30510	1	1004779	4014486716900
MOWER DECK DRIVE	TCU31132	1	1004775	4014486716863
MOWER DECK DRIVE	TCU31132	1	1004782	4014486716931

### Z920M W/54IN

MOWER DECK	TCU30356	1	1004785	4014486716962
MOWER DECK	TCU30510	1	1004779	4014486716900
MOWER DECK DRIVE	TCU31132	1	1004775	4014486716863
MOWER DECK DRIVE	TCU31132	1	1004782	4014486716931

### Z920M W/60IN

MOWER DECK	TCU30356	1	1004785	4014486716962
MOWER DECK	TCU30510	1	1004779	4014486716900
MOWER DECK DRIVE	TCU31132	1	1004775	4014486716863
MOWER DECK DRIVE	TCU31132	1	1004782	4014486716931

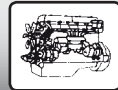

## JOHN DEERE – TURF N CARE

### Z920R W/48IN

MID-Z MOWER DECK	TCU30510	1	1004779	4014486716900
MID-Z MOWER DECK	TCU31132	1	1004782	4014486716931
MOWER DECK DRIVE	TCU31132	1	1004775	4014486716863

### Z920R W/54IN

MID-Z ISO MOWER DECK	TCU30510	1	1004779	4014486716900
MID-Z MOWER DECK	TCU30510	1	1004779	4014486716900
MID-Z ISO MOWER DECK	TCU31132	1	1004782	4014486716931
MID-Z MOWER DECK	TCU31132	1	1004782	4014486716931
MOWER DECK DRIVE	TCU31132	1	1004775	4014486716863
MOWER DECK DRIVE	TCU31132	1	1004775	4014486716863

### Z925A Z-Trak Pro Series Mower

MOD MOWER DECK	TCU29453	1	1004781	4014486716924
MOWER DECK	TCU29453	1	1004781	4014486716924
MOWER DECK	TCU29453	1	1004781	4014486716924

### Z925A Z-Trak EFI Pro Series

MOD MOWER DECK	TCU29454	1	1004784	4014486716955
MOWER DECK	TCU29454	1	1004784	4014486716955

### Z925A Z-Trak EFI Pro Series Mower

MOD MOWER DECK	TCU29453	1	1004781	4014486716924
MOWER DECK	TCU29453	1	1004781	4014486716924

### Z925A Z-Trak Pro Mower W/54IN

MOD MOWER DECK	TCU29454	1	1004784	4014486716955
MOWER DECK	TCU29454	1	1004784	4014486716955

### Z925A Z-Trak Pro Mower W/60IN

MOWER DECK	TCU29454	1	1004784	4014486716955
------------	----------	---	---------	---------------

### Z925M-EFI W/54IN

MOWER DECK	TCU30356	1	1004785	4014486716962
MOWER DECK DRIVE	TCU31132	1	1004775	4014486716863
MOWER DECK DRIVE	TCU31132	1	1004782	4014486716931

### Z925M-EFI W/60IN

MOWER DECK	TCU30356	1	1004785	4014486716962
MOWER DECK DRIVE	TCU31132	1	1004775	4014486716863
MOWER DECK DRIVE	TCU31132	1	1004782	4014486716931

### Z930A W/60IN

Pro Series Mower Mod Mower Deck	TCU29455	1	1004787	4014486716986
Pro Series Mower Mower Deck	TCU29455	1	1004787	4014486716986

### Z930A W/72IN

Pro Series Mower Mower Deck	TCU29455	1	1004787	4014486716986
-----------------------------	----------	---	---------	---------------

### Z930A Z-Trak Pro Mower W/60IN

MOD MOWER DECK	TCU29454	1	1004784	4014486716955
MOWER DECK	TCU29454	1	1004784	4014486716955

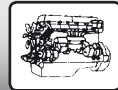

## JOHN DEERE – TURF N CARE

### Z930A Z-Trak Pro Mower W/72IN

MOWER DECK	TCU29454	1	1004784	4014486716955
------------	----------	---	---------	---------------

### Z930M EFI MowerIN

MOD-Z MOWER DECK	TCU30356	1	1004785	4014486716962
------------------	----------	---	---------	---------------

### Z930M EFI W/60IN

MID-Z MOWER DECK	TCU30356	1	1004785	4014486716962
------------------	----------	---	---------	---------------

### Z930M W/60IN

MID-Z MOWER DECK	TCU30356	1	1004785	4014486716962
MOD-Z MOWER DECK	TCU30356	1	1004785	4014486716962
MID-Z MOWER DECK	TCU31194	1	1004786	4014486716979
MOD-Z MOWER DECK	TCU31194	1	1004786	4014486716979

### Z930M W/72IN

MID-Z MOWER DECK	TCU30356	1	1004785	4014486716962
MID-Z MOWER DECK	TCU31194	1	1004786	4014486716979

### Z930R

	TCU30356	1	1004785	4014486716962
--	----------	---	---------	---------------

### Z950A W/60IN

Pro Series Mower Mod Mower Deck	TCU29455	1	1004787	4014486716986
Pro Series Mower Mower Deck	TCU29455	1	1004787	4014486716986

### Z950A W/72IN

Pro Series Mower Mower Deck	TCU29455	1	1004787	4014486716986
-----------------------------	----------	---	---------	---------------

### Z950A Z-Trak Pro Mower W/60IN

MOD MOWER DECK	TCU29454	1	1004784	4014486716955
MOWER DECK	TCU29454	1	1004784	4014486716955

### Z950A Z-Trak Pro Mower W/72IN

MOWER DECK	TCU29454	1	1004784	4014486716955
------------	----------	---	---------	---------------

### Z950R W/60IN

MID-Z MOWER DECK	TCU30356	1	1004785	4014486716962
MOD-Z MOWER DECK	TCU30356	1	1004785	4014486716962
MID-Z MOWER DECK	TCU31194	1	1004786	4014486716979
MOD-Z MOWER DECK	TCU31194	1	1004786	4014486716979

### Z950R W/72IN

MID-Z MOWER DECK	TCU30356	1	1004785	4014486716962
MID-Z MOWER DECK	TCU31194	1	1004786	4014486716979

### Z960A W/60IN

Pro Series Mower Mod Mower Deck	TCU29455	1	1004787	4014486716986
Pro Series Mower Mower Deck	TCU29455	1	1004787	4014486716986

### Z960A W/72IN

Pro Series Mower Mower Deck	TCU29455	1	1004787	4014486716986
-----------------------------	----------	---	---------	---------------

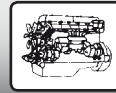

# JOHN DEERE – TURF N CARE

## Z960A Z-Trak Pro Mower W/60IN

MOD MOWER DECK	TCU29454	1	1004784	4014486716955
MOWER DECK	TCU29454	1	1004784	4014486716955

## Z960A Z-Trak Pro Mower W/72IN

MOWER DECK	TCU29454	1	1004784	4014486716955
------------	----------	---	---------	---------------

## Z960R W/60IN

MID-Z MOWER DECK	TCU30356	1	1004785	4014486716962
MOD-Z MOWER DECK	TCU30356	1	1004785	4014486716962
MID-Z MOWER DECK	TCU31194	1	1004786	4014486716979
MOD-Z MOWER DECK	TCU31194	1	1004786	4014486716979

## Z960R W/72IN

MID-Z MOWER DECK	TCU30356	1	1004785	4014486716962
MID-Z MOWER DECK	TCU31194	1	1004786	4014486716979

## Z970A W/72IN

Pro Series Mower Mower Deck	TCU29455	1	1004787	4014486716986
-----------------------------	----------	---	---------	---------------

## Z970R

MOWER	TCU31194	1	1004786	4014486716979
-------	----------	---	---------	---------------

AG - BI  
CA - CL  
DE - DR  
FE - FO  
GO - GR  
IN - JO  
KP - KZ  
LA - ME  
NE - RO  
SA - ST  
VA - ZM  
PARTS  
SERVICE







# KRONE

	2133350	1	1004682	4014486719772
	2150791	1	1001331	4014486492958
	2211880	1	1003730	4014486495287
	2240410	1	1001970	4014486490824
	2266930	1	1001333	4014486492972
	2279090	1	1001332	4014486492965
	2279091	1	1001332	4014486492965
	2279251	1	1001966	4014486490770
	2282321	1	1003722	4014486494990
	2282340	1	1003741	4014486495713
	2282350	1	1002601	4014486496086
	2282360	2	1003016	4014486476668
	2282430	1	1002353	4014486478860
	9215002	4	1003029	4014486476996
	9215010	4	1002675	4014486476880
	9215030	3	1002844	4014486464122
	9215040	1	1001932	4014486490282
	9215050	4	1002802	4014486520163
	9215060	1	1001803	4014486488135
	9215070	1	1001235	4014486491890
	9215090	1	1001793	4014486488005
	9215101	1	1002292	4014486479775
	9215102	1	1002290	4014486479751
	9215110	1	1002052	4014486475296
	9215121	4	1003030	4014486476644
	9215130	1	1000229	4014486463118
	9215140	1	1001983	4014486491036
	9215151	1	1001940	4014486490374
	9215161	1	1002023	4014486491586
	9215181	1	1002049	4014486475258
	9215190	4	1002188	4014486477337
	9215221	3	1002190	4014486477375
	9215232	4	1003683	4014486477344
	9215241	1	1002024	4014486491593
	9215251	1	1001555	4014486484540
	9215260	4	1003027	4014486477009
	9215270	1	1002065	4014486475456
	9215280	1	1002331	4014486478624
	9215290	5	1000242	4014486463576
	9215310	1	1001580	4014486484854
	9215320	1	1001796	4014486488043
	9215330	1	1003284	4014486484786
	9215360	1	1001792	4014486487992
	9215370	1	1002032	4014486491678
	9215380	1	1001596	4014486485158
	9215390	1	1001988	4014486491081
	9215400	4	1003031	4014486477221
	9215412	1	1003394	4014486462692
	9215420	1	1001602	4014486485240
	9215450	1	1002288	4014486479713
	9215470	1	1001791	4014486487985
	9215520	1	1001587	4014486484984
	9215530	1	1002341	4014486478747
	9215540	1	1001574	4014486484793
	9215550	1	1001555	4014486484540



## KRONE

	9215560	1	1001791	4014486487985
	9215570	1	1001796	4014486488043
	9215580	1	1004566	4014486717310
	9215931	4	1002140	4014486476521
	9215962	4	1002160	4014486476804
	9215981	4	1003026	4014486476453
	9216000	3	1003032	4014486477115
	9216010	3	1004306	4014486683042
	9216070	4	1002171	4014486477054
	200160010	1	1001970	4014486490824
	200213740	1	1004684	4014486721423
	200213750	1	1004680	4014486719758
	200214040	2	No AP	
	200225360	1	No AP	
	200229240	3	No AP	
	200236560	3	No AP	
	270003340	1	1004751	4014486719178
	270009750	4	1004772	4014486716849
	270010830	1	1004683	4014486721416
	270012960	3	No AP	
	270016482	1	1004617	4014486717471
	270016491	1	1004620	4014486717501
	270022770	1	1004619	4014486717495
	270029402	1	1004639	4014486718850
	270036620	1	1004847	4014486717167
	270036680	1	1004378	4014486714487
	270042650	1	1001332	4014486492965
	270042651	1	1004681	4014486719765
	270045470	1	1004828	4014486720846
	270050730	1	1004810	4014486720518
	270050740	1	1002065	4014486475456
	270059850	1	1003961	4014486485264
	270063910	1	1004671	4014486719727
	270073020	1	1001598	4014486485172
	270076720	1	1004616	4014486717464
	270078750	1	1004570	4014486717358
	270079810	1	1004308	4014486713893
	270084780	1	1004661	4014486718768
	270084781	1	1004662	4014486718775
	270085110	1	1004664	4014486720877
	270085120	1	1004644	4014486718546
	270085130	1	1004510	4014486717198
	270085150	1	1004638	4014486718843
	270086200	1	1004670	4014486719710
	270087820	1	1004634	4014486718539
	270089770	1	1004657	4014486718881
	270089880	1	No AP	
	270092541	1	1004796	4014486719444
	270095150	1	1004637	4014486718577
	270095930	1	1001340	4014486474527
	270095940	1	1004881	4014486720839
	270096080	1	1004645	4014486718836
	270096090	1	1004849	4014486718256
	270096100	1	1004665	4014486720884
	270096890	1	1002061	4014486475418



# KRONE

		270097250	5	1004776	4014486716870
		270103490	1	1004881	4014486720839
		270104120	1	No AP	
		270104130	1	1004495	4014486718249
		02153350	2	1003012	4014486476569
		02282360	2	1003016	4014486476668
		02282430	1	1002353	4014486478860
		09215002	1	1004083	4014486476972
		09215010	4	1002675	4014486476880
		09215030	3	1002844	4014486464122
		09215050	4	1002802	4014486520163
		09215101	2	1004799	4014486720433
		09215102	2	1004808	4014486720426
		09215110	1	1002052	4014486475296
		09215121	4	1003030	4014486476644
		09215130	1	1000229	4014486463118
		09215181	1	1002049	4014486475258
		09215190	4	1002188	4014486477337
		09215221	3	1002190	4014486477375
		09215232	4	1003683	4014486477344
		09215251	1	1001555	4014486484540
		09215260	4	1003027	4014486477009
		09215270	1	1002065	4014486475456
		09215280	1	1002331	4014486478624
		09215290	5	1000242	4014486463576
		09215300	3	1000255	4014486464023
		09215310	1	1001580	4014486484854
		09215330	1	1003284	4014486484786
		09215380	1	1001596	4014486485158
		09215400	4	1003031	4014486477221
		09215412	1	1003394	4014486462692
		09215420	1	1001602	4014486485240
		09215451	1	1004822	4014486719420
		09215460	1	No AP	
		09215520	1	1001587	4014486484984
		09215530	1	1002341	4014486478747
		09215540	1	1001574	4014486484793
		09215601	1	1000259	4014486464115
		09215931	4	1002140	4014486476521
		09215962	4	1002160	4014486476804
		09215981	4	1003026	4014486476453
		09216000	3	1003032	4014486477115
		09216010	3	1004306	4014486683042
		09216030	1	1000489	4014486467611
		09216070	4	1002171	4014486477054
		270107440	1	No AP	
		E020T17	1	1004005	4014486519389

## BIG X 1000

1	MAIN DRIVE BIG X 1000	200211640	1	1004154	4014486523683
2	GRAIN CONDITIONER CPL TAFEL 31 - 37 BIG X 1000	2168800	1	1001294	4014486492460
3	CRACKER DRIVE / TENSIONING DEVICE BIG X 1000	2168800	1	1001294	4014486492460
6	VENTILATOR DRIVE BIG X 1000	200225361	1	1001584	4014486484915
7	SIEVE DRUM BIG X 1000	200208260	1	1004113	4014486522884



# KRONE

## BIG X 500

1	MAIN DRIVE BIG X 500	2159940	1	1004643	4014486718867
2	GRAIN CONDITIONER CPL TAFEL 31 - 37 BIG X 500	2168800	1	1001294	4014486492460
3	CRACKER DRIVE / TENSIONING DEVICE BIG X 500	2168800	1	1001294	4014486492460
6	SIEVE DRUM BIG X 500	2253610	1	1000182	4014486462111
6	SIEVE DRUM BIG X 500	02253610	1	1000182	4014486462111

## BIG X 650

1	MAIN DRIVE BIG X 650	2279101	1	1003580	4014486492897
2	GRAIN CONDITIONER CPL TAFEL 33 - 39 BIG X 650	2168800	1	1001294	4014486492460
3	CRACKER DRIVE / TENSIONING DEVICE BIG X 650	2168800	1	1001294	4014486492460
4	DIESEL ENGINE / CLUTCH / AIR CONDITIONER DRIVE BIG X 650	2282330	1	1003730	4014486495287
6	SUCTION SYSTEM DRIVE BIG X 650	2253560	1	1002363	4014486478976
6	SIEVE DRUM BIG X 500	2253610	1	1000182	4014486462111
6	SUCTION SYSTEM DRIVE BIG X 650	200216850	2	1004178	4014486523010
6	SUCTION SYSTEM DRIVE BIG X 650	02253560	1	1002363	4014486478976
6	SIEVE DRUM BIG X 500	02253610	1	1000182	4014486462111

## BIG X 800

1	MAIN DRIVE BIG X 800	200211640	1	1004154	4014486523683
2	GRAIN CONDITIONER CPL TAFEL 31 - 37 BIG X 800	2168800	1	1001294	4014486492460
3	CRACKER DRIVE / TENSIONING DEVICE BIG X 800	2168800	1	1001294	4014486492460
6	VENTILATOR DRIVE BIG X 800	200225361	1	1001584	4014486484915
7	SIEVE DRUM BIG X 800	200208260	1	1004113	4014486522884

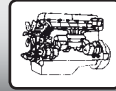

AG - BI  
CA - CL  
DE - DR  
FE - FO  
GO - GR  
IN - JO  
KP - KZ  
LA - ME  
NE - RO  
SA - ST  
VA - ZM  
PARTS  
SERVICE

# KUHN

	83101059	1	1002275	4014486478433
	83101067	1	1002272	4014486478402
	83101252	6	1002337	4014486478693
	83101253	3	1002342	4014486478754
	83101270	2	1002060	4014486475401
	83101656	2	1002386	4014486479256
	83101658	2	1002383	4014486479195
	83101670	1	1002161	4014486476811
	83101672	3	1003022	4014486476842
	83101673	4	1003023	4014486476859
	83101680	3	1002370	4014486479058
	83101682	4	1002374	4014486479102
	83101687	3	1003056	4014486479218
	83101688	4	1003057	4014486479225
	83101764	2	1002366	4014486478990
	83101785	1	1003416	4014486463620
	83101791	4	1002398	4014486479393
	83101792	4	1002399	4014486479409
	83101795	2	1000258	4014486464061
	83101796	2	1000270	4014486464382
	83101797	2	1000279	4014486464542
	83101798	2	1002845	4014486464658
	83111677	1	1001173	4014486497359
	83111679	1	1001219	4014486497526
	83111682	1	1001191	4014486497304
	83111683	1	1001192	4014486497311

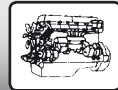

## KVERNELAND

	1099	1	1001280	4014486474466
	1160	1	1001279	4014486474459
	1224	1	1001278	4014486474442
	37771407	1	1000295	4014486464870
	43301603	1	1003439	4014486464900
	43303407	1	1002401	4014486479430
	43303410	1	1002373	4014486479089
	43303412	1	1002377	4014486479126
	43303413	1	1002371	4014486479065
	43303417	1	1002376	4014486479119
	43303418	1	1002402	4014486479454
	43303420	1	1002364	4014486478983
	43303424	1	1002384	4014486479232
	43303426	1	1002395	4014486479362
	43303427	1	1002306	4014486479942
	43303429	1	1002305	4014486479935
	43303432	1	1002382	4014486479188
	43303434	1	1002393	4014486479348
	99201011	1	1000093	4014486460919
	99201014	1	1000104	4014486461077
	99201017	1	1000108	4014486461121
	99201020	1	1000113	4014486461206
	99201032	1	1000137	4014486461541
	99201038	1	1000141	4014486461589
	99201040	1	1000142	4014486461596
	99201411	1	1002044	4014486475197
	99201412	1	1002040	4014486475159
	99201413	1	1002041	4014486475166
	99201414	1	1002045	4014486475210
	99201418	1	1002050	4014486475265
	99201420	1	1002084	4014486475746
	99201422	1	1002085	4014486475753
	99201424	1	1002086	4014486475760
	99201510	2	1002330	4014486478594
	99202008	1	1002293	4014486479782
	99202009	2	1003045	4014486479799
	99202011	2	1002294	4014486479812
	99202012	1	1000204	4014486462449
	99202013	4	1004194	4014486599381
	99202014	3	1002785	4014486463019
	99202015	1	1000216	4014486462777
	99202016	3	1002757	4014486463200
	99202017	1	1000231	4014486520491
	99202018	4	1002846	4014486463248
	99202019	3	1002778	4014486463071
	99202021	3	1002805	4014486463446
	99202022	1	1000240	4014486463484
	99202024	4	1003046	4014486519266
	99202025	1	1003421	4014486463842
	99202026	1	1003422	4014486463811
	99202027	4	1003763	4014486463873
	99202028	4	1002847	4014486463859
	99202031	1	1000257	4014486464047
	99202032	1	1002308	4014486479966
	99202035	1	1000292	4014486464825

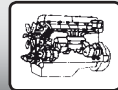

## KVERNELAND

	99202036	1	1000298	4014486464931
	99202038	1	1000303	4014486465068
	99202039	1	1000305	4014486465105
	99202040	1	1003441	4014486465020
	99202041	1	1000313	4014486465273
	99202042	3	1000248	4014486463781
	99202062	1	1000370	4014486466331
	99202063	1	1000373	4014486466362
	99202220	1	1002243	4014486478099
	99202322	1	1001790	4014486487978
	99202325	1	1001794	4014486488012
	99202409	1	1002367	4014486479010
	99202410	3	1003058	4014486479027
	99202412	1	1002117	4014486476170
	99202413	1	1002118	4014486476194
	99202415	1	1002115	4014486476163
	99202420	1	1002133	4014486476385
	99202423	1	1002174	4014486477108
	99202424	3	1003236	4014486477122
	99202425	4	1003033	4014486519181
	99202428	3	1002203	4014486477542
	99202429	4	1002195	4014486477443
	99202430	4	1002129	4014486476347
	99202431	4	1003034	4014486477269
	99202433	4	1004303	4014486683011
	99203005	1	1000538	4014486468199
	99203006	1	1000539	4014486468205
	99203008	1	1000544	4014486468267
	99203010	1	1003486	4014486468304
	99203012	1	1000553	4014486468434
	99203014	1	1000561	4014486468601
	99203015	1	1000565	4014486468700
	99203016	4	1002895	4014486468618
	99203017	1	1003497	4014486468830
	99203018	1	1000575	4014486468847
	99203019	4	1002897	4014486520248
	99203020	3	1002898	4014486468724
	99203021	1	1003507	4014486469226
	99203022	3	1002900	4014486469134
	99203023	1	1000596	4014486469257
	99203024	4	1002899	4014486468717
	99203025	3	1003766	4014486468861
	99203026	4	1003767	4014486520231
	99203027	3	1002896	4014486468878
	99203029	1	1000624	4014486520262
	99203038	1	1000675	4014486470475
	99203039	1	1000679	4014486470529
	99203042	1	1000697	4014486470789
	99203045	1	1003545	4014486470994
	99203046	2	1000711	4014486471014
	99203048	1	1000716	4014486471069
	99203050	1	1000724	4014486471168
	99203052	1	1000732	4014486471267
	99203056	1	1000745	4014486471410
	99203063	1	1000769	4014486471748



## KVERNELAND

	99203082	2	1002902	4014486468533
	99203083	2	1002903	4014486468571
	99203085	1	1000576	4014486468854
	99203086	4	1002904	4014486468885
	99203087	1	1000578	4014486468939
	99203088	2	1002905	4014486468946
	99203090	1	1000588	4014486469110
	99203091	4	1002901	4014486469141
	99203093	1	1000684	4014486470628
	99203203	3	1000767	4014486471700
	99203204	5	1002906	4014486520071
	99203208	1	1002241	4014486478075
	99203210	1	1002242	4014486478082
	99203211	1	1002244	4014486478105
	99203212	1	1002225	4014486477825
	99203213	1	1002227	4014486477856
	99203215	3	1002221	4014486477771
	99203216	1	1002222	4014486477788
	99203218	3	1003040	4014486477863
	99203245	1	1002254	4014486478211
	99203250	1	1002255	4014486478228
	99203310	1	1001150	4014486496390
	99203315	1	1001151	4014486496406
	99203320	1	1001152	4014486496413
	99203330	1	1001272	4014486492415
	99203331	1	1001273	4014486492408
	99203332	1	1001274	4014486492392
	99203333	1	1001153	4014486496420
	99203335	1	1001154	4014486496437
	99203415	1	1000912	4014486473612
	99203418	1	1000918	4014486473674
	99203419	1	1000919	4014486473681
	99203422	1	1000922	4014486473711
	99204062	2	1000969	4014486474282
	99204076	2	1000973	4014486474336
	99207010	1	1001345	4014486474589
	99207113	1	1001348	4014486474619
	99207225	1	1001341	4014486474534
	0000930	1	1000206	4014486462463
	0000930D	1	1000206	4014486462463
	0000930M	1	1002296	4014486479836
	0000939	1	1003334	4014486462586
	0000942	1	1000208	4014486462500
	0000942D	1	1000208	4014486462500
	0000943	1	1000544	4014486468267
	0000944	1	1003490	4014486468410
	0001108	1	1002271	4014486478396
	0001218	1	1002273	4014486478419
	01142085	1	1002404	4014486479478
	AC494745	1	1001026	4014486498011
	AC494836	1	1001025	4014486497984
	AC690011	1	1002416	4014486479607
	AC690071	1	1002739	4014486479591
	AC690081	1	1002419	4014486479638
	AC690115	1	1002413	4014486479577



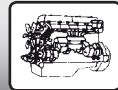

## KVERNELAND

	AC690123	1	1002417	4014486479614
	AC690131	1	1002420	4014486479645
	AC690132	1	1002419	4014486479638
	AC690137	1	1002411	4014486479553
	AC690138	1	1002418	4014486479621
	AC690140	1	1000989	4014486498004
	AC690149	1	1002414	4014486479584
	AC690150	1	1002416	4014486479607
	AC690164	1	1002410	4014486479546
	AC690181	1	1002412	4014486479560
	AC690201	1	1002407	4014486479515
	AC690202	1	1002406	4014486479508
	ND9036	1	1003674	4014486475821
	ND9073	1	1002095	4014486475883
	ND9092	1	1002197	4014486477467
	ND9198	1	1003676	4014486476460
	ND9240	1	1003673	4014486475661
	ND9257	1	1002052	4014486475296
	ND9359	1	1003681	4014486477146
	ND9471	1	1003680	4014486477061
	ND96001	1	1000369	4014486466317
	ND96006	1	1000733	4014486471274
	ND96008	1	1002103	4014486475999
	ND96016	1	1002185	4014486477290
	ND96023	1	1002202	4014486477528
	ND96029	1	1000397	4014486466607
	ND96053	1	1003684	4014486477351
	ND96063	1	1002099	4014486475937
	ND96067	1	1002184	4014486477283
	ND96068	1	1002196	4014486477450
	ND96070	1	1002159	4014486476798
	ND96074	1	1002050	4014486475265
	ND96075	1	1002204	4014486477559
	ND96078	1	1002579	4014486495560
	ND96082	1	1002327	4014486478563
	ND96083	1	1002054	4014486475319
	ND96084	1	1003682	4014486477207
	ND96085	1	1002328	4014486478570
	ND96087	1	1002191	4014486477382
	ND96089	1	1002189	4014486477368
	ND96090	1	1002063	4014486475432
	ND96091	1	1002194	4014486477436
	ND96096	1	1002356	4014486478891
	ND96108	1	1002166	4014486476910
	ND96109	1	1002139	4014486476507
	ND9629	1	1002328	4014486478570
	ND9630	1	1003692	4014486478655
	ND9674	1	1000361	4014486466195
	ND9704	1	1002187	4014486477320
	ND9732	1	1002388	4014486479270
	ND9775	1	1002144	4014486476583
	ND9909	1	1002132	4014486476378
	ND9928	1	1002375	4014486479096
	ND9958	1	1002179	4014486477191
	RG00035618	1	1002274	4014486478426





## KZK YENISEY

	28X16 X 1180 LP	1	1003306	4014486496611
	28X16 X 1450 LP	1	1003307	4014486496635
	38X18 X 1500 LP	1	1001003	4014486497267
	38X18 X 2000 LP	1	1003308	4014486497281
	38X18 X 2400 LP	1	1003309	4014486497298
	3-HB 1650 LA	1	1003290	4014486488036
	3-HB 2215 LA	1	1003291	4014486488357
	3-HB 2302 LA	1	1003292	4014486488418
	3-HB 2462 LA	1	1003293	4014486488524
	3-HB 2907 LA	1	1003294	4014486488845
	3-HB 3820 LA	1	1003295	4014486489392
	45X22 X 2385 LP	1	1003310	4014486497595
	45X22 X 4000 LP	1	1002723	4014486497656
	4-HB 1662 LA	1	1003296	4014486490329
	4-HB 1877 LA	1	1003297	4014486490381
	4-HB 2200 LA	1	1003298	4014486490497
	4-HB 2215 LA	1	1003299	4014486490534
	4-HB 2907 LA	1	1003300	4014486490862
	4-HB 3820 LA	1	1003301	4014486491210
	5-HB 2777 LA	1	1003302	4014486492019
	5-HB 3820 LA	1	1003303	4014486492279
	5-HB 4012 LA	1	1003304	4014486492286
	5-HB 6377 LA	1	1003305	4014486492361
	KB 2/5V 1900 LA	1	1003288	4014486487787
	KB 2/5V 2120 LA	1	1003289	4014486487794
	2-HB 1862 LA	1	1003283	4014486484625
	2-HB 1962 LA	1	1001568	4014486484717
	2-HB 2062 LA	1	1003284	4014486484786
	2-HB 3820 LA	1	1003285	4014486486223
	2-HB 4432 LA	1	1003286	4014486486438
	2-HB 4562 LA	1	1003287	4014486486469
	A 2530 LP	1	1003378	4014486461664
	A 2800 LP	1	1000156	4014486461787
	A 3150 LP	1	1003269	4014486461947
	A 3750 LP	1	1003270	4014486462043
	B 2420 LP	1	1003271	4014486465051
	C 1900 LP	1	1003272	4014486468762
	C 2000 LP	1	1000579	4014486468960
	C 2120 LP	1	1000590	4014486520255
	C 2240 LP	1	1000597	4014486469295
	C 2800 LP	4	1003273	4014486470130
	C 2810 LP	1	1003527	4014486470147
	C 3000 LP	1	1003274	4014486470437
	C 3081 LP	1	1003275	4014486470574
	C 3750 LP	1	1000736	4014486471298
	C 4276 LP	1	1003276	4014486471724
	C 4750 LP	4	1003318	4014486472103
	C 7500 LP	2	1003320	4014486473001
	D 1900 LP	1	1003282	4014486480115
	D 2120 LP	1	1003277	4014486473902
	D 3475 LP	1	1002702	4014486474121
	D 3750 LP	1	1003278	4014486474176
	D 4500 LP	1	1003279	4014486474305
	D 5300 LP	1	1000972	4014486474329
	HCM 2010 LA	1	1003280	4014486474985



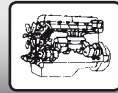
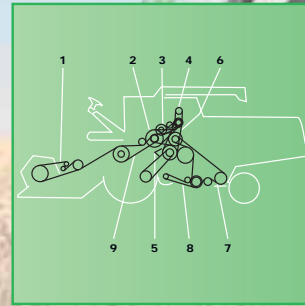
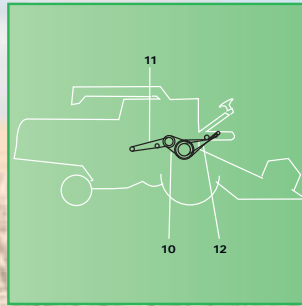
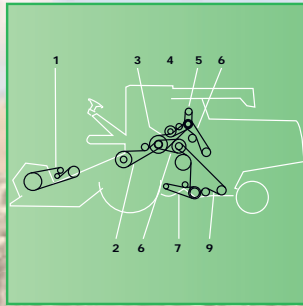
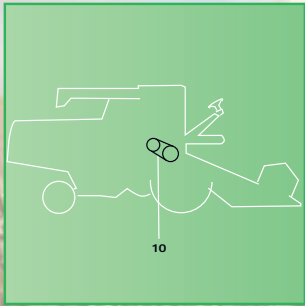

# LAVERDA

3200					
10	CYLINDER VARIATOR DRIVE	340435138	1	1004295	4014486683318
3300					
7	AIR CONDITIONING COMPRESSOR DRIVE 292	H80896	1	1002570	4014486495355
7	AIR CONDITIONING COMPRESSOR DRIVE	H81742	1	No AP	
10	CYLINDER VARIATOR DRIVE	340435138	1	1004295	4014486683318
23	ROTARY SCREEN DRIVE	H86259	1	No AP	
24	COUNTERSHAFT (SECONDARY)	H138762	1	1000710	4014486470987
28	UNLOADING AUGER COUNTERSHAFT	H76136	1	1000542	4014486468243
3400					
3	THRESHING MECHANISM DRIVE	344311318	1	1002000	4014486491265
3	THRESHING MECHANISM DRIVE	LA344311318	1	1002000	4014486491265
5	AIR CONDITIONED CAB INSTALLATION	340433129	1	1000104	4014486461077
6	TRANSMISSION	344311126	1	1003608	4014486485851
6	TRANSMISSION	LA344311126	1	1003608	4014486485851
8	REAR BEATER TO DRIVE TRANSMISSION	340433539	1	1001120	4014486497069
8	REAR BEATER TO DRIVE TRANSMISSION	LA340433539	1	1001120	4014486497069
10	STRAW WALKER DRIVE	340433316	1	1000367	4014486466294
11	AUGER DRIVES	340433446	1	1000787	4014486472035
11	AUGER DRIVES	LA340433446	1	1000787	4014486472035
12	RADIATOR FILTER TRANSMISSION	340433181	1	1003379	4014486461701
12	RADIATOR FILTER TRANSMISSION	LA340433181	1	1003379	4014486461701
13	RADIATOR FILTER TRANSMISSION	340433134	1	1003369	4014486461107
13	RADIATOR FILTER TRANSMISSION	LA340433134	1	1003369	4014486461107
14	DRUM VARIATOR	340435147	1	1003848	4014486460261
15	FAN VARIATOR	340435150	1	1001422	4014486459296
15	FAN VARIATOR	LA340435150	1	1001422	4014486459296
16	FAN VARIATOR	340435151	1	1001419	4014486459265
17	FAN DRIVE	340433191	1	1000170	4014486461961
18	SECONDARY CLEANER DRIVE	340433469	1	1000624	4014486520262
3500					
1	REEL DRIVE VARIABLE SPEED	340434138	1	1001061	4014486496451
1	REEL DRIVE VARIABLE SPEED	LA340434138	1	1001061	4014486496451
2	COMPRESSOR DRIVE	340433129	1	1000104	4014486461077
3	FILTER ROTARY (SECONDARY)	340433134	1	1003369	4014486461107
3	FILTER ROTARY (SECONDARY)	LA340433134	1	1003369	4014486461107
5		340433191	1	1000170	4014486461961
7	STRAW WALKER DRIVE	340433316	1	1000367	4014486466294
8		344311126	1	1003608	4014486485851
8		LA344311126	1	1003608	4014486485851
10	CYLINDER DRIVE	344311318	1	1002000	4014486491265
10	CYLINDER DRIVE	LA344311318	1	1002000	4014486491265
13	CONVERTER DRIVE	340433422	1	1000606	4014486520514
14		340433469	1	1000624	4014486520262
16	AUGER DRIVE TAILINGS AND GRAIN	340433446	1	1000787	4014486472035
16	AUGER DRIVE TAILINGS AND GRAIN	LA340433446	1	1000787	4014486472035
19	RETURN DRIVE	340433539	1	1001120	4014486497069
19	RETURN DRIVE	LA340433539	1	1001120	4014486497069
20	CYLINDER DRIVE	340435147	1	1003848	4014486460261

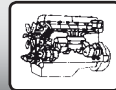

## LAVERDA

### 3550

1	AIR CONDITIONED CAB INSTALLATION	340433129	1	1000104	4014486461077
2	STRAW WALKER DRIVE	340433316	1	1000367	4014486466294
3	AUGER DRIVE	340433446	1	1000787	4014486472035
3	AUGER DRIVE	LA340433446	1	1000787	4014486472035
5	REAR BEATER TO DRIVE TRANSMISSION	340433539	1	1001120	4014486497069
5	REAR BEATER TO DRIVE TRANSMISSION	LA340433539	1	1001120	4014486497069
8	TRANSMISSION	344311126	1	1003608	4014486485851
8	TRANSMISSION	LA344311126	1	1003608	4014486485851
10	THRESHING MECHANISM DRIVE	344311318	1	1002000	4014486491265
10	THRESHING MECHANISM DRIVE	LA344311318	1	1002000	4014486491265
11	RADIATOR FILTER TRANSMISSION	340433181	1	1003379	4014486461701
11	RADIATOR FILTER TRANSMISSION	LA340433181	1	1003379	4014486461701
12	DRUM VARIATOR	340435147	1	1003848	4014486460261
13	FAN VARIATOR	340435150	1	1001422	4014486459296
13	FAN VARIATOR	LA340435150	1	1001422	4014486459296
14	FAN VARIATOR	340435151	1	1001419	4014486459265
15	RADIATOR FILTER TRANSMISSION	340433134	1	1003369	4014486461107
15	RADIATOR FILTER TRANSMISSION	LA340433134	1	1003369	4014486461107

### 3600

1		344311127	1	1001637	4014486485868
1		LA344311127	1	1001637	4014486485868
3	MAIN FAN	340433424	1	1004842	4014486715590
4	AUGER DRIVE TAILINGS AND GRAIN	344311134	1	1004071	4014486520347
8	COMPRESSOR DRIVE	340433129	1	1000104	4014486461077
11	CYLINDER VARIATOR DRIVE	344311318	1	1002000	4014486491265
11	CYLINDER VARIATOR DRIVE	LA344311318	1	1002000	4014486491265
12	REEL DRIVE VARIABLE SPEED	340434138	1	1001061	4014486496451
12	REEL DRIVE VARIABLE SPEED	LA340434138	1	1001061	4014486496451
16	CYLINDER DRIVE	340435152	1	1001539	4014486460582
16	CYLINDER DRIVE	LA340435152	1	1001539	4014486460582

### 3650

1	REEL DRIVE VARIABLE SPEED	340434138	1	1001061	4014486496451
1	REEL DRIVE VARIABLE SPEED	LA340434138	1	1001061	4014486496451
2	COMPRESSOR DRIVE	340433129	1	1000104	4014486461077
7		344311127	1	1001637	4014486485868
7		LA344311127	1	1001637	4014486485868
8	AUGER DRIVE TAILINGS AND GRAIN	344311134	1	1004071	4014486520347
9	STRAW CHOPPER DRIVE	344311137	1	1001679	4014486486483
10	CYLINDER DRIVE	344311318	1	1002000	4014486491265
10	CYLINDER DRIVE	LA344311318	1	1002000	4014486491265
12	CONVERTER DRIVE	340433422	1	1000606	4014486520514
15	STRAW WALKER DRIVE	340433457	1	1003833	4014486519945
16	RETURN DRIVE	340433539	1	1001120	4014486497069
16	RETURN DRIVE	LA340433539	1	1001120	4014486497069
17	MAIN FAN	340435150	1	1001422	4014486459296
17	MAIN FAN	LA340435150	1	1001422	4014486459296
18	CYLINDER VARIATOR DRIVE	340435152	1	1001539	4014486460582
18	CYLINDER VARIATOR DRIVE	LA340435152	1	1001539	4014486460582

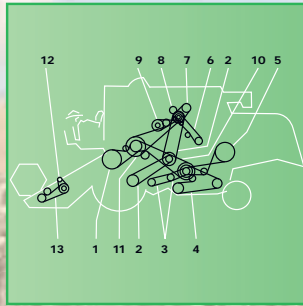
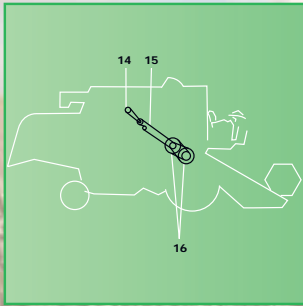

# LAVERDA

3700					
1		344311127	1	1001637	4014486485868
1		LA344311127	1	1001637	4014486485868
3	MAIN FAN	340433424	1	1004842	4014486715590
4	AUGER DRIVE TAILINGS AND GRAIN	344311134	1	1004071	4014486520347
8	COMPRESSOR DRIVE	340433129	1	1000104	4014486461077
11	CYLINDER VARIATOR DRIVE	344311318	1	1002000	4014486491265
11	CYLINDER VARIATOR DRIVE	LA344311318	1	1002000	4014486491265
12	REEL DRIVE VARIABLE SPEED	340434138	1	1001061	4014486496451
12	REEL DRIVE VARIABLE SPEED	LA340434138	1	1001061	4014486496451
3750					
1	REEL DRIVE VARIABLE SPEED	340434138	1	1001061	4014486496451
1	REEL DRIVE VARIABLE SPEED	LA340434138	1	1001061	4014486496451
2	COMPRESSOR DRIVE	340433129	1	1000104	4014486461077
7		344311127	1	1001637	4014486485868
7		LA344311127	1	1001637	4014486485868
8	AUGER DRIVE TAILINGS AND GRAIN	344311134	1	1004071	4014486520347
9	STRAW CHOPPER DRIVE	344311137	1	1001679	4014486486483
10	HYDRAULIC PUMP DRIVE	344311226	1	1001835	4014486488593
10	HYDRAULIC PUMP DRIVE	LA344311226	1	1001835	4014486488593
11	CYLINDER DRIVE	344311318	1	1002000	4014486491265
11	CYLINDER DRIVE	LA344311318	1	1002000	4014486491265
13	CONVERTER DRIVE	340433422	1	1000606	4014486520514
16	STRAW WALKER DRIVE	340433457	1	1003833	4014486519945
17	RETURN DRIVE	340433539	1	1001120	4014486497069
17	RETURN DRIVE	LA340433539	1	1001120	4014486497069
18	MAIN FAN	340435150	1	1001422	4014486459296
18	MAIN FAN	LA340435150	1	1001422	4014486459296
19	CYLINDER VARIATOR DRIVE	340435152	1	1001539	4014486460582
19	CYLINDER VARIATOR DRIVE	LA340435152	1	1001539	4014486460582
3790					
1	REEL DRIVE VARIABLE SPEED	340434138	1	1001061	4014486496451
1	REEL DRIVE VARIABLE SPEED	LA340434138	1	1001061	4014486496451
2	COMPRESSOR DRIVE	340433129	1	1000104	4014486461077
7		344311127	1	1001637	4014486485868
7		LA344311127	1	1001637	4014486485868
8	AUGER DRIVE TAILINGS AND GRAIN	344311134	1	1004071	4014486520347
9	STRAW CHOPPER DRIVE	344311137	1	1001679	4014486486483
10	HYDRAULIC PUMP DRIVE	344311226	1	1001835	4014486488593
10	HYDRAULIC PUMP DRIVE	LA344311226	1	1001835	4014486488593
11	CYLINDER DRIVE	344311318	1	1002000	4014486491265
11	CYLINDER DRIVE	LA344311318	1	1002000	4014486491265
13	CONVERTER DRIVE	340433422	1	1000606	4014486520514
16	STRAW WALKER DRIVE	340433457	1	1003833	4014486519945
17	RETURN DRIVE	340433539	1	1001120	4014486497069
17	RETURN DRIVE	LA340433539	1	1001120	4014486497069
18	MAIN FAN	340435150	1	1001422	4014486459296
18	MAIN FAN	LA340435150	1	1001422	4014486459296

AG - BI  
CA - CL  
DE - DR  
FE - FO  
GO - GR  
IN - JO  
KP - KZ  
LA - ME  
NE - RO  
SA - ST  
VA - ZM  
PARTS  
SERVICE

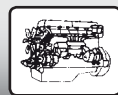
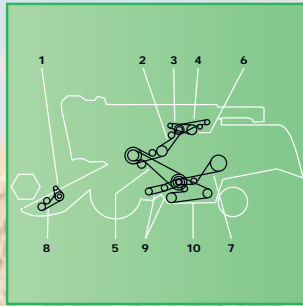
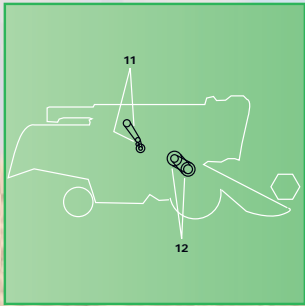

## LAVERDA

3850					
1	REEL DRIVE VARIABLE SPEED	340434138	1	1001061	4014486496451
1	REEL DRIVE VARIABLE SPEED	LA340434138	1	1001061	4014486496451
2	COMPRESSOR DRIVE	340433129	1	1000104	4014486461077
7	AUGER DRIVE TAILINGS AND GRAIN	344311134	1	1004071	4014486520347
8	STRAW CHOPPER DRIVE	344311137	1	1001679	4014486486483
9	CYLINDER DRIVE	344311318	1	1002000	4014486491265
9	CYLINDER DRIVE	LA344311318	1	1002000	4014486491265
12	CONVERTER (E)	340433422	1	1000606	4014486520514
13	STRAW WALKER DRIVE	340433457	1	1003833	4014486519945
15	RETURN DRIVE	340433539	1	1001120	4014486497069
15	RETURN DRIVE	LA340433539	1	1001120	4014486497069
16	MAIN FAN	340435150	1	1001422	4014486459296
16	MAIN FAN	LA340435150	1	1001422	4014486459296
3890					
1	REEL DRIVE VARIABLE SPEED	340434138	1	1001061	4014486496451
1	REEL DRIVE VARIABLE SPEED	LA340434138	1	1001061	4014486496451
2	COMPRESSOR DRIVE	340433129	1	1000104	4014486461077
7	AUGER DRIVE TAILINGS AND GRAIN	344311134	1	1004071	4014486520347
8	STRAW CHOPPER DRIVE	344311137	1	1001679	4014486486483
9	HYDRAULIC PUMP DRIVE	344311226	1	1001835	4014486488593
9	HYDRAULIC PUMP DRIVE	LA344311226	1	1001835	4014486488593
10	CYLINDER VARIATOR DRIVE	344311318	1	1002000	4014486491265
10	CYLINDER VARIATOR DRIVE	LA344311318	1	1002000	4014486491265
14	CONVERTER (E)	340433422	1	1000606	4014486520514
15	STRAW WALKER DRIVE	340433457	1	1003833	4014486519945
17	RETURN DRIVE	340433539	1	1001120	4014486497069
17	RETURN DRIVE	LA340433539	1	1001120	4014486497069
18	MAIN FAN	340435150	1	1001422	4014486459296
18	MAIN FAN	LA340435150	1	1001422	4014486459296
3900					
1	REEL DRIVE VARIABLE SPEED	340434138	1	1001061	4014486496451
1	REEL DRIVE VARIABLE SPEED	LA340434138	1	1001061	4014486496451
7	STRAW WALKER DRIVE	340433457	1	1003833	4014486519945
9	MAIN FAN	340433424	1	1004842	4014486715590
10	AUGER DRIVE TAILINGS AND GRAIN	344311134	1	1004071	4014486520347
	AUGER DRIVE TAILINGS AND GRAIN	340435127	1	1004072	4014486520125

### LAVERDA

		28263119	1	1004297	4014486683288
		28263120	1	1004281	4014486683127
		28263240	1	1004284	4014486683189
		28264254	1	1004294	4014486683264
		41990027	1	1004300	4014486683059
		87800127	1	1002567	4014486495270
		340344276	1	1000271	4014486464399
		340433132	1	1000101	4014486461022
		340433141	1	1000115	4014486461237
		340433166	1	1004274	4014486682885
		340433195	1	1004275	4014486682892
		340433198	1	1000165	4014486461893
		340433280	1	1004276	4014486682908





## LAVERDA

	340433985	1	1001360	4014486474749
	340433986	1	1001362	4014486474763
	340435155	1	1001540	4014486460599
	344311117	1	1003592	4014486484939
	344311121	1	1001591	4014486485035
	344311124	1	1001624	4014486485592
	344311128	1	1001637	4014486485868
	344311129	1	1001642	4014486485943
	344311132	1	1004283	4014486683073
	344311229	1	1004286	4014486683165
	344311230	1	1001888	4014486489453
	344311231	1	1003852	4014486489590
	344311232	1	1001882	4014486489330
	344311233	1	1001820	4014486488371
	344311236	1	1004287	4014486683172
	344311238	1	1003630	4014486488333
	344311239	1	1004290	4014486683219
	344311240	1	1004285	4014486683158
	344311309	1	1004289	4014486683196
	344311320	1	1001882	4014486489330
	344411229	1	1001820	4014486488371
	344411318	1	1002000	4014486491265
	344435155	1	1001540	4014486460599
	984909360	1	1002562	4014486495157
	3404339850	1	1001360	4014486474749
	3404339860	1	1001362	4014486474763
	3443112310	1	1003852	4014486489590
	3443112320	1	1001882	4014486489330
	340435146K	1	1004271	4014486682861
	6237302M1	1	1003038	4014486519860
	6247230M1	1	1004293	4014486683240
	6247231M1	1	1004069	4014486520200
	6247232M1	1	1004277	4014486682939
	6247944M1	1	1004291	4014486683226
	6247946M1	1	1004296	4014486683271
	6248653M1	1	1004282	4014486683134
	6248658M1	1	1004279	4014486683103
	6248667M1	1	1004278	4014486682960
	6248670M1	1	1004280	4014486683110
	7059737M1	1	1004292	4014486683233
	7061016M1	1	1004288	4014486683257
	7061235M1	1	1004298	4014486682984
	7061926M1	1	1004299	4014486683066
	LA340435155	1	1001540	4014486460599
	LA344311117	1	1003592	4014486484939
	LA344311121	1	1001591	4014486485035
	LA344311124	1	1001624	4014486485592
	LA344311128	1	1001637	4014486485868
	LA344311230	1	1001888	4014486489453
	LA344311233	1	1001820	4014486488371
	LA344311318	1	1002000	4014486491265

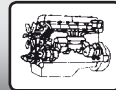
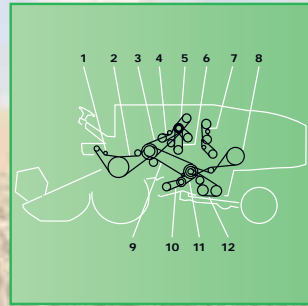
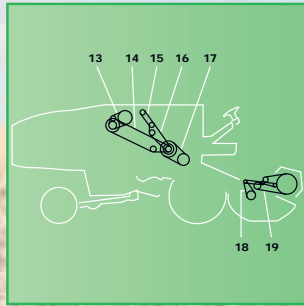
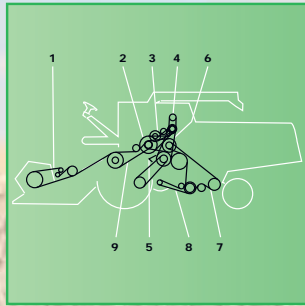
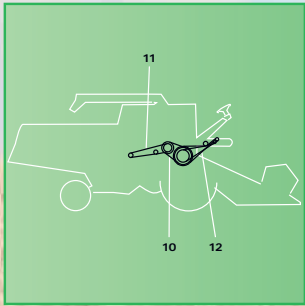

# LAVERDA

## 3300 AL

10	CYLINDER VARIATOR DRIVE	340435138	1	1004295	4014486683318
----	-------------------------	-----------	---	---------	---------------

## 3350 (EX AL 112)

2	ELEVATOR DRIVE UNIT	340433531	1	1000950	4014486474053
9	MAIN RETURN DRIVE	340433537	1	1004272	4014486682977
15	ROTARY FILTER (SECONDARY)	340433134	1	1003369	4014486461107
15	ROTARY FILTER (SECONDARY)	LA340433134	1	1003369	4014486461107
16	ROTARY FILTER (PRIMARY)	340433162	1	1004273	4014486682878
17	FEEDER SHAFT	340435146	1	1004271	4014486682861
18	REEL DRIVE VARIABLE SPEED	340434140	1	1000999	4014486497229

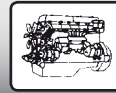
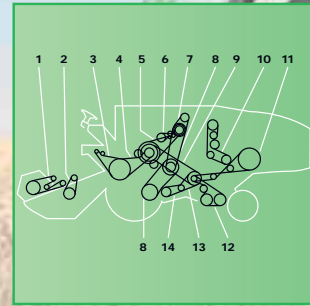
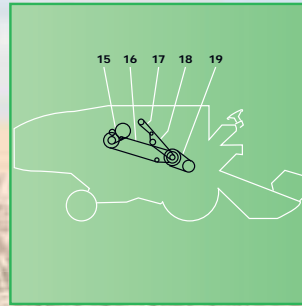
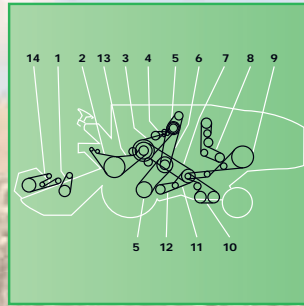
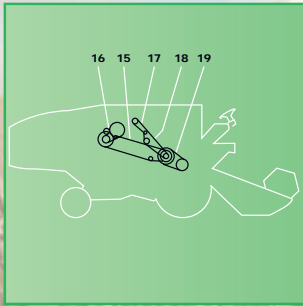

# LAVERDA

## 3350 (EX M 112)

1	REEL DRIVE VARIABLE SPEED (1978)	340434138	1	1001061	4014486496451
1	REEL DRIVE VARIABLE SPEED	340434140	1	1000999	4014486497229
1	REEL DRIVE VARIABLE SPEED (1978)	LA340434138	1	1001061	4014486496451
7	RETURN DRIVE	340433537	1	1004272	4014486682977
13		340433531	1	1000950	4014486474053
14	REEL DRIVE (1978)	340433316	1	1000367	4014486466294
14	REEL DRIVE	340433435	1	1000702	4014486470857
17	ROTARY FILTER DRIVE	340433134	1	1003369	4014486461107
17	ROTARY FILTER DRIVE	LA340433134	1	1003369	4014486461107
18	FILTER	340433162	1	1004273	4014486682878

## 3400 R

3	THRESHING MECHANISM DRIVE	344311318	1	1002000	4014486491265
3	THRESHING MECHANISM DRIVE	LA344311318	1	1002000	4014486491265
5	AIR CONDITIONED CAB INSTALLATION	340433129	1	1000104	4014486461077
6	TRANSMISSION	344311126	1	1003608	4014486485851
6	TRANSMISSION	LA344311126	1	1003608	4014486485851
8	REAR BEATER TO DRIVE TRANSMISSION	340433539	1	1001120	4014486497069
8	REAR BEATER TO DRIVE TRANSMISSION	LA340433539	1	1001120	4014486497069
10	STRAW WALKER DRIVE	340433316	1	1000367	4014486466294
11	AUGER DRIVE	340433446	1	1000787	4014486472035
11	AUGER DRIVE	LA340433446	1	1000787	4014486472035
12	RADIATOR FILTER TRANSMISSION	340433181	1	1003379	4014486461701
12	RADIATOR FILTER TRANSMISSION	LA340433181	1	1003379	4014486461701
13	RADIATOR FILTER TRANSMISSION	340433134	1	1003369	4014486461107
13	RADIATOR FILTER TRANSMISSION	LA340433134	1	1003369	4014486461107
14	DRUM VARIATOR	340435147	1	1003848	4014486460261
15	FAN VARIATOR	340435150	1	1001422	4014486459296
15	FAN VARIATOR	LA340435150	1	1001422	4014486459296
16	FAN VARIATOR	340435151	1	1001419	4014486459265
17	FAN DRIVE	340433191	1	1000170	4014486461961
18	SECONDARY CLEANER DRIVE	340433469	1	1000624	4014486520262
	RADIATOR FILTER TRANSMISSION	340433134	1	1003369	4014486461107
	RADIATOR FILTER TRANSMISSION	LA340433134	1	1003369	4014486461107

## 3450 (EX AL 132)

1	REEL DRIVE (1978)	340433316	1	1000367	4014486466294
1	REEL DRIVE	340433435	1	1000702	4014486470857
2	REEL DRIVE VARIABLE SPEED	340434138	1	1001061	4014486496451
2	REEL DRIVE VARIABLE SPEED	340434140	1	1000999	4014486497229
2	REEL DRIVE VARIABLE SPEED	LA340434138	1	1001061	4014486496451
4		340433531	1	1000950	4014486474053
9	MAIN RETURN DRIVE	340433537	1	1004272	4014486682977
17	ROTARY FILTER (SECONDARY)	340433134	1	1003369	4014486461107
17	ROTARY FILTER (SECONDARY)	LA340433134	1	1003369	4014486461107
18	ROTARY FILTER (PRIMARY)	340433162	1	1004273	4014486682878

## 3500 R

1	AIR CONDITIONED CAB INSTALLATION	340433129	1	1000104	4014486461077
2	STRAW WALKER DRIVE	340433316	1	1000367	4014486466294
3	AUGER DRIVE	340433446	1	1000787	4014486472035
3	AUGER DRIVE	LA340433446	1	1000787	4014486472035
5	REAR BEATER TO DRIVE TRANSMISSION	340433539	1	1001120	4014486497069



## LAVERDA

5	REAR BEATER TO DRIVE TRANSMISSION	LA340433539	1	1001120	4014486497069
8	TRANSMISSION	344311126	1	1003608	4014486485851
8	TRANSMISSION	LA344311126	1	1003608	4014486485851
10	THRESHING MECHANISM DRIVE	344311318	1	1002000	4014486491265
10	THRESHING MECHANISM DRIVE	LA344311318	1	1002000	4014486491265
11	RADIATOR FILTER TRANSMISSION	340433181	1	1003379	4014486461701
11	RADIATOR FILTER TRANSMISSION	LA340433181	1	1003379	4014486461701
12	DRUM VARIATOR	340435147	1	1003848	4014486460261
13	FAN VARIATOR	340435150	1	1001422	4014486459296
13	FAN VARIATOR	LA340435150	1	1001422	4014486459296
14	FAN VARIATOR	340435151	1	1001419	4014486459265
15	RADIATOR FILTER TRANSMISSION	340433134	1	1003369	4014486461107
15	RADIATOR FILTER TRANSMISSION	LA340433134	1	1003369	4014486461107

### 3550 AL

1		340434138	1	1001061	4014486496451
1		LA340434138	1	1001061	4014486496451
2		340433129	1	1000104	4014486461077
3		340433134	1	1003369	4014486461107
3		LA340433134	1	1003369	4014486461107
4	RADIATOR FILTER TRANSMISSION	340433181	1	1003379	4014486461701
4	RADIATOR FILTER TRANSMISSION	LA340433181	1	1003379	4014486461701
5		340433191	1	1000170	4014486461961
8		340433316	1	1000367	4014486466294
9		344311126	1	1003608	4014486485851
9		LA344311126	1	1003608	4014486485851
10		344311226	1	1001835	4014486488593
10		LA344311226	1	1001835	4014486488593
11		344311318	1	1002000	4014486491265
11		LA344311318	1	1002000	4014486491265
14		340433469	1	1000624	4014486520262
16		340433446	1	1000787	4014486472035
16		LA340433446	1	1000787	4014486472035
19		340433539	1	1001120	4014486497069
19		LA340433539	1	1001120	4014486497069
20		340435147	1	1003848	4014486460261

### 3550 R

1	AIR CONDITIONED CAB INSTALLATION	340433129	1	1000104	4014486461077
2	STRAW WALKER DRIVE	340433316	1	1000367	4014486466294
3	AUGER DRIVE	340433446	1	1000787	4014486472035
3	AUGER DRIVE	LA340433446	1	1000787	4014486472035
5	REAR BEATER TO DRIVE TRANSMISSION	340433539	1	1001120	4014486497069
5	REAR BEATER TO DRIVE TRANSMISSION	LA340433539	1	1001120	4014486497069
8	TRANSMISSION	344311126	1	1003608	4014486485851
8	TRANSMISSION	LA344311126	1	1003608	4014486485851
10	THRESHING MECHANISM DRIVE	344311318	1	1002000	4014486491265
10	THRESHING MECHANISM DRIVE	LA344311318	1	1002000	4014486491265
11	RADIATOR FILTER TRANSMISSION	340433181	1	1003379	4014486461701
11	RADIATOR FILTER TRANSMISSION	LA340433181	1	1003379	4014486461701
12	DRUM VARIATOR	340435147	1	1003848	4014486460261
13	FAN VARIATOR	340435150	1	1001422	4014486459296
13	FAN VARIATOR	LA340435150	1	1001422	4014486459296
14	FAN VARIATOR	340435151	1	1001419	4014486459265
15	RADIATOR FILTER TRANSMISSION	340433134	1	1003369	4014486461107

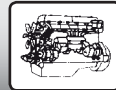

## LAVERDA

15	RADIATOR FILTER TRANSMISSION	LA340433134	1	1003369	4014486461107
<b>3560 AL</b>					
		340433129	1	1000104	4014486461077
		340433539	1	1001120	4014486497069
		340434138	1	1001061	4014486496451
		340435150	1	1001422	4014486459296
		344311139	1	1001688	4014486486629
		344311318	1	1002000	4014486491265
		LA340433539	1	1001120	4014486497069
		LA340434138	1	1001061	4014486496451
		LA340435150	1	1001422	4014486459296
		LA344311318	1	1002000	4014486491265
<b>3560AL</b>					
		340433422	1	1000606	4014486520514
<b>3650 R</b>					
		340433129	1	1000104	4014486461077
		340433422	1	1000606	4014486520514
		340433475	1	1000588	4014486469110
	RETURN DRIVE	340433539	1	1001120	4014486497069
	REEL DRIVE VARIABLE SPEED	340434138	1	1001061	4014486496451
		340435131	1	1003847	4014486460124
	MAIN FAN	340435150	1	1001422	4014486459296
	CYLINDER DRIVE	344311318	1	1002000	4014486491265
	RETURN DRIVE	LA340433539	1	1001120	4014486497069
		LA340433984	1	1001346	4014486474596
		LA340433984	1	1001346	4014486474596
	REEL DRIVE VARIABLE SPEED	LA340434138	1	1001061	4014486496451
	MAIN FAN	LA340435150	1	1001422	4014486459296
	CYLINDER DRIVE	LA344311318	1	1002000	4014486491265
<b>3750 R</b>					
		340433129	1	1000104	4014486461077
		340433422	1	1000606	4014486520514
		340433475	1	1000588	4014486469110
	RETURN DRIVE	340433539	1	1001120	4014486497069
	REEL DRIVE VARIABLE SPEED	340434138	1	1001061	4014486496451
		340435131	1	1003847	4014486460124
	MAIN FAN	340435150	1	1001422	4014486459296
	CYLINDER DRIVE	344311318	1	1002000	4014486491265
	RETURN DRIVE	LA340433539	1	1001120	4014486497069
		LA340433984	1	1001346	4014486474596
		LA340433984	1	1001346	4014486474596
	REEL DRIVE VARIABLE SPEED	LA340434138	1	1001061	4014486496451
	MAIN FAN	LA340435150	1	1001422	4014486459296
	CYLINDER DRIVE	LA344311318	1	1002000	4014486491265
<b>L 517</b>					
1	POST CYLINDER VARIATOR DRIVE	344311318	1	1002000	4014486491265
1	POST CYLINDER VARIATOR DRIVE	LA344311318	1	1002000	4014486491265
2	STRAW ELEVATOR DRIVE	344311127	1	1001637	4014486485868
2	STRAW ELEVATOR DRIVE	344312128	1	1003623	4014486487503
2	STRAW ELEVATOR DRIVE	LA344311127	1	1001637	4014486485868

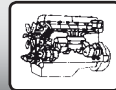

## LAVERDA

2	STRAW ELEVATOR DRIVE	LA344312128	1	1003623	4014486487503
3	AUGER DRIVE TAILINGS AND GRAIN	344311123	1	1001622	4014486485554
4	FAN RETURN DRIVE	340433539	1	1001120	4014486497069
4	FAN RETURN DRIVE	LA340433539	1	1001120	4014486497069
6	DISCHARGE DRIVE GRAIN TANK	340433475	1	1000588	4014486469110
7	ROTARY FILTER DRIVE	340433181	1	1003379	4014486461701
7	ROTARY FILTER DRIVE	LA340433181	1	1003379	4014486461701
8	CYLINDER VARIATOR DRIVE	340435152	1	1001539	4014486460582
8	CYLINDER VARIATOR DRIVE	LA340435152	1	1001539	4014486460582
9	FAN DRIVE	340435150	1	1001422	4014486459296
9	FAN DRIVE	LA340435150	1	1001422	4014486459296
11	CENTRAL RETURN DRIVE	LA340433984	1	1001346	4014486474596
11	CENTRAL RETURN DRIVE	LA340433984	1	1001346	4014486474596
12	REEL DRIVE VARIABLE SPEED	340434138	1	1001061	4014486496451
12	REEL DRIVE VARIABLE SPEED	LA340434138	1	1001061	4014486496451
14	COMPRESSOR DRIVE	340433131	1	1000106	4014486461091
16		340433260	1	1000241	4014486463552
17		340433270	1	1000256	4014486464054
18	CHOPPER DRIVE	344311130	1	1001652	4014486486056
19	CHOPPER DRIVE	344311151	1	1001717	4014486486995
19	CHOPPER DRIVE	LA344311151	1	1001717	4014486486995
21	PUMP DRIVE	344311228	1	1003630	4014486488333
36	FAN DRIVE	340433159	1	1000135	4014486461527
38	FAN DRIVE	340435153	1	1001424	4014486459319
38	FAN DRIVE	LA340435153	1	1001424	4014486459319

### L 518

16		340433260	1	1000241	4014486463552
36	FAN DRIVE	340433159	1	1000135	4014486461527
		340433268	1	1000252	4014486463941
		340433270	1	1000256	4014486464054
	FAN DRIVE	340433405	1	1000554	4014486468472
	DISCHARGE DRIVE GRAIN TANK	340433475	1	1000588	4014486469110
	FAN RETURN DRIVE	340433539	1	1001120	4014486497069
		340434138	1	1001061	4014486496451
		340435150	1	1001422	4014486459296
		340435152	1	1001539	4014486460582
	FAN DRIVE	340435153	1	1001424	4014486459319
	CHOPPER DRIVE	344311151	1	1001717	4014486486995
	PUMP DRIVE	344311228	1	1003630	4014486488333
	POST CYLINDER VARIATOR DRIVE	344311318	1	1002000	4014486491265
	STRAW ELEVATOR DRIVE	344312128	1	1003623	4014486487503
	FAN DRIVE	LA340433405	1	1000554	4014486468472
	FAN RETURN DRIVE	LA340433539	1	1001120	4014486497069
		LA340433984	1	1001346	4014486474596
		LA340433984	1	1001346	4014486474596
		LA340434138	1	1001061	4014486496451
		LA340435150	1	1001422	4014486459296
		LA340435152	1	1001539	4014486460582
	FAN DRIVE	LA340435153	1	1001424	4014486459319
	CHOPPER DRIVE	LA344311151	1	1001717	4014486486995
	POST CYLINDER VARIATOR DRIVE	LA344311318	1	1002000	4014486491265
	STRAW ELEVATOR DRIVE	LA344312128	1	1003623	4014486487503

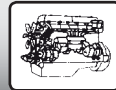

# LAVERDA

## L 520

16		340433260	1	1000241	4014486463552
36	FAN DRIVE	340433159	1	1000135	4014486461527
		340433268	1	1000252	4014486463941
		340433270	1	1000256	4014486464054
	FAN DRIVE	340433405	1	1000554	4014486468472
	DISCHARGE DRIVE GRAIN TANK	340433475	1	1000588	4014486469110
	FAN RETURN DRIVE	340433539	1	1001120	4014486497069
		340434138	1	1001061	4014486496451
		340435150	1	1001422	4014486459296
		340435152	1	1001539	4014486460582
	FAN DRIVE	340435153	1	1001424	4014486459319
	CHOPPER DRIVE	344311151	1	1001717	4014486486995
	PUMP DRIVE	344311228	1	1003630	4014486488333
	POST CYLINDER VARIATOR DRIVE	344311318	1	1002000	4014486491265
	STRAW ELEVATOR DRIVE	344312128	1	1003623	4014486487503
	FAN DRIVE	LA340433405	1	1000554	4014486468472
	FAN RETURN DRIVE	LA340433539	1	1001120	4014486497069
		LA340433984	1	1001346	4014486474596
		LA340433984	1	1001346	4014486474596
		LA340434138	1	1001061	4014486496451
		LA340435150	1	1001422	4014486459296
		LA340435152	1	1001539	4014486460582
	FAN DRIVE	LA340435153	1	1001424	4014486459319
	CHOPPER DRIVE	LA344311151	1	1001717	4014486486995
	POST CYLINDER VARIATOR DRIVE	LA344311318	1	1002000	4014486491265
	STRAW ELEVATOR DRIVE	LA344312128	1	1003623	4014486487503

## L 521

1	POST CYLINDER VARIATOR DRIVE	344311318	1	1002000	4014486491265
1	POST CYLINDER VARIATOR DRIVE	LA344311318	1	1002000	4014486491265
2	STRAW ELEVATOR DRIVE	344311127	1	1001637	4014486485868
2	STRAW ELEVATOR DRIVE	344312128	1	1003623	4014486487503
2	STRAW ELEVATOR DRIVE	LA344311127	1	1001637	4014486485868
2	STRAW ELEVATOR DRIVE	LA344312128	1	1003623	4014486487503
3	AUGER DRIVE TAILINGS AND GRAIN	344311123	1	1001622	4014486485554
4	FAN RETURN DRIVE	340433539	1	1001120	4014486497069
4	FAN RETURN DRIVE	LA340433539	1	1001120	4014486497069
6	DISCHARGE DRIVE GRAIN TANK	340433475	1	1000588	4014486469110
7	ROTARY FILTER DRIVE	340433181	1	1003379	4014486461701
7	ROTARY FILTER DRIVE	LA340433181	1	1003379	4014486461701
8	CYLINDER VARIATOR DRIVE	340435152	1	1001539	4014486460582
8	CYLINDER VARIATOR DRIVE	LA340435152	1	1001539	4014486460582
9	FAN DRIVE	340435150	1	1001422	4014486459296
9	FAN DRIVE	LA340435150	1	1001422	4014486459296
11	CENTRAL RETURN DRIVE	LA340433984	1	1001346	4014486474596
11	CENTRAL RETURN DRIVE	LA340433984	1	1001346	4014486474596
12	REEL DRIVE VARIABLE SPEED	340434138	1	1001061	4014486496451
12	REEL DRIVE VARIABLE SPEED	LA340434138	1	1001061	4014486496451
14	COMPRESSOR DRIVE	340433131	1	1000106	4014486461091
15		340433262	1	1000244	4014486520156
15		LA340433262	1	1000244	4014486520156
18	CHOPPER DRIVE	344311130	1	1001652	4014486486056
19	CHOPPER DRIVE	344311151	1	1001717	4014486486995

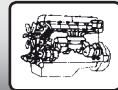

## LAVERDA

19	CHOPPER DRIVE	LA344311151	1	1001717	4014486486995
20		340433151	1	1000124	4014486461367
22	HYDRAULIC PUMP DRIVE	344311227	1	1001820	4014486488371
22	HYDRAULIC PUMP DRIVE	LA344311227	1	1001820	4014486488371
36	FAN DRIVE	340433159	1	1000135	4014486461527
37	HYDRAULIC PUMP DRIVE	340433259	1	1000225	4014486463033
		340433253	1	1000231	4014486520491
		340433270	1	1000256	4014486464054
	CYLINDER VARIATOR DRIVE	340435152	1	1001539	4014486460582
	FAN DRIVE	340435153	1	1001424	4014486459319
		LA340433253	1	1000231	4014486520491
	CYLINDER VARIATOR DRIVE	LA340435152	1	1001539	4014486460582
	FAN DRIVE	LA340435153	1	1001424	4014486459319

### L 523 - INTEGRALE

36	FAN DRIVE	340433159	1	1000135	4014486461527
		340433253	1	1000231	4014486520491
	HYDRAULIC PUMP DRIVE	340433259	1	1000225	4014486463033
		340433262	1	1000244	4014486520156
		340433270	1	1000256	4014486464054
	FAN DRIVE	340433405	1	1000554	4014486468472
	DISCHARGE DRIVE GRAIN TANK	340433475	1	1000588	4014486469110
	FAN RETURN DRIVE	340433539	1	1001120	4014486497069
	REEL DRIVE VARIABLE SPEED	340434138	1	1001061	4014486496451
	FAN DRIVE	340435150	1	1001422	4014486459296
	CYLINDER VARIATOR DRIVE	340435152	1	1001539	4014486460582
	FAN DRIVE	340435153	1	1001424	4014486459319
	CHOPPER DRIVE	344311151	1	1001717	4014486486995
	HYDRAULIC PUMP DRIVE	344311227	1	1001820	4014486488371
	POST CYLINDER VARIATOR DRIVE	344311318	1	1002000	4014486491265
	STRAW ELEVATOR DRIVE	344312128	1	1003623	4014486487503
		LA340433253	1	1000231	4014486520491
		LA340433262	1	1000244	4014486520156
	FAN DRIVE	LA340433405	1	1000554	4014486468472
	FAN RETURN DRIVE	LA340433539	1	1001120	4014486497069
		LA340433984	1	1001346	4014486474596
		LA340433984	1	1001346	4014486474596
	REEL DRIVE VARIABLE SPEED	LA340434138	1	1001061	4014486496451
	FAN DRIVE	LA340435150	1	1001422	4014486459296
	CYLINDER VARIATOR DRIVE	LA340435152	1	1001539	4014486460582
	FAN DRIVE	LA340435153	1	1001424	4014486459319
	CHOPPER DRIVE	LA344311151	1	1001717	4014486486995
	HYDRAULIC PUMP DRIVE	LA344311227	1	1001820	4014486488371
	POST CYLINDER VARIATOR DRIVE	LA344311318	1	1002000	4014486491265
	STRAW ELEVATOR DRIVE	LA344312128	1	1003623	4014486487503

### L 523 - MCS

36	FAN DRIVE	340433159	1	1000135	4014486461527
		340433253	1	1000231	4014486520491
	HYDRAULIC PUMP DRIVE	340433259	1	1000225	4014486463033
		340433262	1	1000244	4014486520156
		340433268	1	1000252	4014486463941
		340433270	1	1000256	4014486464054
	FAN DRIVE	340433405	1	1000554	4014486468472
	DISCHARGE DRIVE GRAIN TANK	340433475	1	1000588	4014486469110





## LAVERDA

	FAN RETURN DRIVE	340433539	1	1001120	4014486497069
	REEL DRIVE VARIABLE SPEED	340434138	1	1001061	4014486496451
	FAN DRIVE	340435150	1	1001422	4014486459296
	CYLINDER VARIATOR DRIVE	340435152	1	1001539	4014486460582
	FAN DRIVE	340435153	1	1001424	4014486459319
	CHOPPER DRIVE	344311151	1	1001717	4014486486995
	HYDRAULIC PUMP DRIVE	344311227	1	1001820	4014486488371
	POST CYLINDER VARIATOR DRIVE	344311318	1	1002000	4014486491265
	STRAW ELEVATOR DRIVE	344312128	1	1003623	4014486487503
		LA340433253	1	1000231	4014486520491
		LA340433262	1	1000244	4014486520156
	FAN DRIVE	LA340433405	1	1000554	4014486468472
	FAN RETURN DRIVE	LA340433539	1	1001120	4014486497069
		LA340433984	1	1001346	4014486474596
		LA340433984	1	1001346	4014486474596
	REEL DRIVE VARIABLE SPEED	LA340434138	1	1001061	4014486496451
	FAN DRIVE	LA340435150	1	1001422	4014486459296
	CYLINDER VARIATOR DRIVE	LA340435152	1	1001539	4014486460582
	FAN DRIVE	LA340435153	1	1001424	4014486459319
	CHOPPER DRIVE	LA344311151	1	1001717	4014486486995
	HYDRAULIC PUMP DRIVE	LA344311227	1	1001820	4014486488371
	POST CYLINDER VARIATOR DRIVE	LA344311318	1	1002000	4014486491265
	STRAW ELEVATOR DRIVE	LA344312128	1	1003623	4014486487503

### L 524

1	POST CYLINDER VARIATOR DRIVE	344311318	1	1002000	4014486491265
1	POST CYLINDER VARIATOR DRIVE	LA344311318	1	1002000	4014486491265
2	STRAW ELEVATOR DRIVE	344311127	1	1001637	4014486485868
2	STRAW ELEVATOR DRIVE	344312128	1	1003623	4014486487503
2	STRAW ELEVATOR DRIVE	LA344311127	1	1001637	4014486485868
2	STRAW ELEVATOR DRIVE	LA344312128	1	1003623	4014486487503
3	AUGER DRIVE TAILINGS AND GRAIN	344311123	1	1001622	4014486485554
4	FAN RETURN DRIVE	340433539	1	1001120	4014486497069
4	FAN RETURN DRIVE	LA340433539	1	1001120	4014486497069
6	DISCHARGE DRIVE GRAIN TANK	340433475	1	1000588	4014486469110
8	CYLINDER VARIATOR DRIVE	340435152	1	1001539	4014486460582
8	CYLINDER VARIATOR DRIVE	LA340435152	1	1001539	4014486460582
9	FAN DRIVE	340435150	1	1001422	4014486459296
9	FAN DRIVE	LA340435150	1	1001422	4014486459296
11	CENTRAL RETURN DRIVE	LA340433984	1	1001346	4014486474596
11	CENTRAL RETURN DRIVE	LA340433984	1	1001346	4014486474596
12	REEL DRIVE VARIABLE SPEED	340434138	1	1001061	4014486496451
12	REEL DRIVE VARIABLE SPEED	LA340434138	1	1001061	4014486496451
14	COMPRESSOR DRIVE	340433131	1	1000106	4014486461091
18	CHOPPER DRIVE	344311130	1	1001652	4014486486056
19	CHOPPER DRIVE	344311151	1	1001717	4014486486995
19	CHOPPER DRIVE	LA344311151	1	1001717	4014486486995
20		340433151	1	1000124	4014486461367
22	HYDRAULIC PUMP DRIVE	344311227	1	1001820	4014486488371
22	HYDRAULIC PUMP DRIVE	LA344311227	1	1001820	4014486488371
36	FAN DRIVE	340433159	1	1000135	4014486461527
		340433253	1	1000231	4014486520491
	HYDRAULIC PUMP DRIVE	340433259	1	1000225	4014486463033
		340433262	1	1000244	4014486520156
		340433270	1	1000256	4014486464054



## LAVERDA

	CYLINDER VARIATOR DRIVE	340435152	1	1001539	4014486460582
	FAN DRIVE	340435153	1	1001424	4014486459319
		LA340433253	1	1000231	4014486520491
		LA340433262	1	1000244	4014486520156
	CYLINDER VARIATOR DRIVE	LA340435152	1	1001539	4014486460582
	FAN DRIVE	LA340435153	1	1001424	4014486459319

### L 525 - INTEGRALE

36	FAN DRIVE	340433159	1	1000135	4014486461527
		340433253	1	1000231	4014486520491
	HYDRAULIC PUMP DRIVE	340433259	1	1000225	4014486463033
		340433262	1	1000244	4014486520156
		340433268	1	1000252	4014486463941
		340433270	1	1000256	4014486464054
	FAN DRIVE	340433405	1	1000554	4014486468472
	DISCHARGE DRIVE GRAIN TANK	340433475	1	1000588	4014486469110
	FAN RETURN DRIVE	340433539	1	1001120	4014486497069
	REEL DRIVE VARIABLE SPEED	340434138	1	1001061	4014486496451
	FAN DRIVE	340435150	1	1001422	4014486459296
	ROTARY FILTER DRIVE	340435152	1	1001539	4014486460582
	FAN DRIVE	340435153	1	1001424	4014486459319
	CHOPPER DRIVE	344311151	1	1001717	4014486486995
	HYDRAULIC PUMP DRIVE	344311227	1	1001820	4014486488371
	POST CYLINDER VARIATOR DRIVE	344311318	1	1002000	4014486491265
	STRAW ELEVATOR DRIVE	344312128	1	1003623	4014486487503
		LA340433253	1	1000231	4014486520491
		LA340433262	1	1000244	4014486520156
	FAN DRIVE	LA340433405	1	1000554	4014486468472
	FAN RETURN DRIVE	LA340433539	1	1001120	4014486497069
		LA340433984	1	1001346	4014486474596
		LA340433984	1	1001346	4014486474596
	REEL DRIVE VARIABLE SPEED	LA340434138	1	1001061	4014486496451
	FAN DRIVE	LA340435150	1	1001422	4014486459296
	ROTARY FILTER DRIVE	LA340435152	1	1001539	4014486460582
	FAN DRIVE	LA340435153	1	1001424	4014486459319
	CHOPPER DRIVE	LA344311151	1	1001717	4014486486995
	HYDRAULIC PUMP DRIVE	LA344311227	1	1001820	4014486488371
	POST CYLINDER VARIATOR DRIVE	LA344311318	1	1002000	4014486491265
	STRAW ELEVATOR DRIVE	LA344312128	1	1003623	4014486487503

### L 525 - MCS

36	FAN DRIVE	340433159	1	1000135	4014486461527
		340433253	1	1000231	4014486520491
	HYDRAULIC PUMP DRIVE	340433259	1	1000225	4014486463033
		340433262	1	1000244	4014486520156
		340433270	1	1000256	4014486464054
	FAN DRIVE	340433405	1	1000554	4014486468472
	DISCHARGE DRIVE GRAIN TANK	340433475	1	1000588	4014486469110
	FAN RETURN DRIVE	340433539	1	1001120	4014486497069
	REEL DRIVE VARIABLE SPEED	340434138	1	1001061	4014486496451
	FAN DRIVE	340435150	1	1001422	4014486459296
	ROTARY FILTER DRIVE	340435152	1	1001539	4014486460582
	FAN DRIVE	340435153	1	1001424	4014486459319
	CHOPPER DRIVE	344311151	1	1001717	4014486486995
	HYDRAULIC PUMP DRIVE	344311227	1	1001820	4014486488371



## LAVERDA

	POST CYLINDER VARIATOR DRIVE	344311318	1	1002000	4014486491265
	STRAW ELEVATOR DRIVE	344312128	1	1003623	4014486487503
		LA340433253	1	1000231	4014486520491
		LA340433262	1	1000244	4014486520156
	FAN DRIVE	LA340433405	1	1000554	4014486468472
	FAN RETURN DRIVE	LA340433539	1	1001120	4014486497069
		LA340433984	1	1001346	4014486474596
		LA340433984	1	1001346	4014486474596
	REEL DRIVE VARIABLE SPEED	LA340434138	1	1001061	4014486496451
	FAN DRIVE	LA340435150	1	1001422	4014486459296
	ROTARY FILTER DRIVE	LA340435152	1	1001539	4014486460582
	FAN DRIVE	LA340435153	1	1001424	4014486459319
	CHOPPER DRIVE	LA344311151	1	1001717	4014486486995
	HYDRAULIC PUMP DRIVE	LA344311227	1	1001820	4014486488371
	POST CYLINDER VARIATOR DRIVE	LA344311318	1	1002000	4014486491265
	STRAW ELEVATOR DRIVE	LA344312128	1	1003623	4014486487503

### L 624

1	POST CYLINDER VARIATOR DRIVE	344311318	1	1002000	4014486491265
1	POST CYLINDER VARIATOR DRIVE	LA344311318	1	1002000	4014486491265
2	STRAW ELEVATOR DRIVE	344311127	1	1001637	4014486485868
2	STRAW ELEVATOR DRIVE	344312128	1	1003623	4014486487503
2	STRAW ELEVATOR DRIVE	LA344311127	1	1001637	4014486485868
2	STRAW ELEVATOR DRIVE	LA344312128	1	1003623	4014486487503
3	AUGER DRIVE TAILINGS AND GRAIN	344311123	1	1001622	4014486485554
4	FAN RETURN DRIVE	340433539	1	1001120	4014486497069
4	FAN RETURN DRIVE	LA340433539	1	1001120	4014486497069
6	DISCHARGE DRIVE GRAIN TANK	340433475	1	1000588	4014486469110
7	ROTARY FILTER DRIVE	340433181	1	1003379	4014486461701
7	ROTARY FILTER DRIVE	LA340433181	1	1003379	4014486461701
9	FAN DRIVE	340435150	1	1001422	4014486459296
9	FAN DRIVE	LA340435150	1	1001422	4014486459296
11	CENTRAL RETURN DRIVE	LA340433984	1	1001346	4014486474596
11	CENTRAL RETURN DRIVE	LA340433984	1	1001346	4014486474596
12	REEL DRIVE VARIABLE SPEED	340434138	1	1001061	4014486496451
12	REEL DRIVE VARIABLE SPEED	LA340434138	1	1001061	4014486496451
14	COMPRESSOR DRIVE	340433131	1	1000106	4014486461091
18	CHOPPER DRIVE	344311130	1	1001652	4014486486056
19	CHOPPER DRIVE	344311151	1	1001717	4014486486995
19	CHOPPER DRIVE	LA344311151	1	1001717	4014486486995
20		340433151	1	1000124	4014486461367
22	HYDRAULIC PUMP DRIVE	344311227	1	1001820	4014486488371
22	HYDRAULIC PUMP DRIVE	LA344311227	1	1001820	4014486488371
36	FAN DRIVE	340433159	1	1000135	4014486461527
		340433253	1	1000231	4014486520491
		340433259	1	1000225	4014486463033
		340433262	1	1000244	4014486520156
		340433270	1	1000256	4014486464054
		340435153	1	1001424	4014486459319
		LA340433253	1	1000231	4014486520491
		LA340433262	1	1000244	4014486520156
		LA340435153	1	1001424	4014486459319



# LAVERDA

## L 625

36		340433159	1	1000135	4014486461527
		340433253	1	1000231	4014486520491
		340433262	1	1000244	4014486520156
		340433268	1	1000252	4014486463941
	FAN DRIVE	340433405	1	1000554	4014486468472
	DISCHARGE DRIVE GRAIN TANK	340433475	1	1000588	4014486469110
	FAN RETURN DRIVE	340433539	1	1001120	4014486497069
	REEL DRIVE VARIABLE SPEED	340434138	1	1001061	4014486496451
	FAN DRIVE	340435150	1	1001422	4014486459296
		340435153	1	1001424	4014486459319
	CHOPPER DRIVE	344311151	1	1001717	4014486486995
	HYDRAULIC PUMP DRIVE	344311227	1	1001820	4014486488371
	POST CYLINDER VARIATOR DRIVE	344311318	1	1002000	4014486491265
	STRAW ELEVATOR DRIVE	344312128	1	1003623	4014486487503
		340435120 K	1	1001468	4014486459784
		LA340433253	1	1000231	4014486520491
		LA340433262	1	1000244	4014486520156
	FAN DRIVE	LA340433405	1	1000554	4014486468472
	FAN RETURN DRIVE	LA340433539	1	1001120	4014486497069
		LA340433984	1	1001346	4014486474596
		LA340433984	1	1001346	4014486474596
	REEL DRIVE VARIABLE SPEED	LA340434138	1	1001061	4014486496451
		LA340435120 K	1	1001468	4014486459784
	FAN DRIVE	LA340435150	1	1001422	4014486459296
		LA340435153	1	1001424	4014486459319
	CHOPPER DRIVE	LA344311151	1	1001717	4014486486995
	HYDRAULIC PUMP DRIVE	LA344311227	1	1001820	4014486488371
	POST CYLINDER VARIATOR DRIVE	LA344311318	1	1002000	4014486491265
	STRAW ELEVATOR DRIVE	LA344312128	1	1003623	4014486487503

## L 626

1	POST CYLINDER VARIATOR DRIVE	344311318	1	1002000	4014486491265
1	POST CYLINDER VARIATOR DRIVE	LA344311318	1	1002000	4014486491265
2	STRAW ELEVATOR DRIVE	344311127	1	1001637	4014486485868
2	STRAW ELEVATOR DRIVE	344312128	1	1003623	4014486487503
2	STRAW ELEVATOR DRIVE	LA344311127	1	1001637	4014486485868
2	STRAW ELEVATOR DRIVE	LA344312128	1	1003623	4014486487503
3	AUGER DRIVE TAILINGS AND GRAIN	344311123	1	1001622	4014486485554
4	FAN RETURN DRIVE	340433539	1	1001120	4014486497069
4	FAN RETURN DRIVE	LA340433539	1	1001120	4014486497069
6	DISCHARGE DRIVE GRAIN TANK	340433475	1	1000588	4014486469110
7	ROTARY FILTER DRIVE	340433181	1	1003379	4014486461701
7	ROTARY FILTER DRIVE	LA340433181	1	1003379	4014486461701
9	FAN DRIVE	340435150	1	1001422	4014486459296
9	FAN DRIVE	LA340435150	1	1001422	4014486459296
11	CENTRAL RETURN DRIVE	LA340433984	1	1001346	4014486474596
11	CENTRAL RETURN DRIVE	LA340433984	1	1001346	4014486474596
12	REEL DRIVE VARIABLE SPEED	340434138	1	1001061	4014486496451
12	REEL DRIVE VARIABLE SPEED	LA340434138	1	1001061	4014486496451
14	COMPRESSOR DRIVE	340433131	1	1000106	4014486461091
18	CHOPPER DRIVE	344311130	1	1001652	4014486486056
19	CHOPPER DRIVE	344311151	1	1001717	4014486486995
19	CHOPPER DRIVE	LA344311151	1	1001717	4014486486995

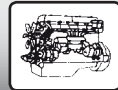

## LAVERDA

20		340433151	1	1000124	4014486461367
22	HYDRAULIC PUMP DRIVE	344311227	1	1001820	4014486488371
22	HYDRAULIC PUMP DRIVE	LA344311227	1	1001820	4014486488371
36	FAN DRIVE	340433159	1	1000135	4014486461527
		340433253	1	1000231	4014486520491
		340433262	1	1000244	4014486520156
		340433270	1	1000256	4014486464054
		340433423	1	1000613	4014486469509
		340435153	1	1001424	4014486459319
		LA340433253	1	1000231	4014486520491
		LA340433262	1	1000244	4014486520156
		LA340435153	1	1001424	4014486459319

### L 627 - INTEGRALE

36		340433159	1	1000135	4014486461527
		340433253	1	1000231	4014486520491
		340433262	1	1000244	4014486520156
		340433268	1	1000252	4014486463941
	FAN DRIVE	340433405	1	1000554	4014486468472
	DISCHARGE DRIVE GRAIN TANK	340433475	1	1000588	4014486469110
	FAN RETURN DRIVE	340433539	1	1001120	4014486497069
	REEL DRIVE VARIABLE SPEED	340434138	1	1001061	4014486496451
	FAN DRIVE	340435150	1	1001422	4014486459296
		340435153	1	1001424	4014486459319
	CHOPPER DRIVE	344311151	1	1001717	4014486486995
	HYDRAULIC PUMP DRIVE	344311227	1	1001820	4014486488371
	POST CYLINDER VARIATOR DRIVE	344311318	1	1002000	4014486491265
	STRAW ELEVATOR DRIVE	344312128	1	1003623	4014486487503
		340435120 K	1	1001468	4014486459784
		LA340433253	1	1000231	4014486520491
		LA340433262	1	1000244	4014486520156
	FAN DRIVE	LA340433405	1	1000554	4014486468472
	FAN RETURN DRIVE	LA340433539	1	1001120	4014486497069
		LA340433984	1	1001346	4014486474596
		LA340433984	1	1001346	4014486474596
	REEL DRIVE VARIABLE SPEED	LA340434138	1	1001061	4014486496451
		LA340435120 K	1	1001468	4014486459784
	FAN DRIVE	LA340435150	1	1001422	4014486459296
		LA340435153	1	1001424	4014486459319
	CHOPPER DRIVE	LA344311151	1	1001717	4014486486995
	HYDRAULIC PUMP DRIVE	LA344311227	1	1001820	4014486488371
	POST CYLINDER VARIATOR DRIVE	LA344311318	1	1002000	4014486491265
	STRAW ELEVATOR DRIVE	LA344312128	1	1003623	4014486487503

### L 627 - MCS

36		340433159	1	1000135	4014486461527
		340433253	1	1000231	4014486520491
		340433262	1	1000244	4014486520156
		340433268	1	1000252	4014486463941
	FAN DRIVE	340433405	1	1000554	4014486468472
	DISCHARGE DRIVE GRAIN TANK	340433475	1	1000588	4014486469110
	FAN RETURN DRIVE	340433539	1	1001120	4014486497069
	REEL DRIVE VARIABLE SPEED	340434138	1	1001061	4014486496451
	FAN DRIVE	340435150	1	1001422	4014486459296
		340435153	1	1001424	4014486459319

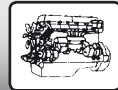

## LAVERDA

	CHOPPER DRIVE	344311151	1	1001717	4014486486995
	HYDRAULIC PUMP DRIVE	344311227	1	1001820	4014486488371
	POST CYLINDER VARIATOR DRIVE	344311318	1	1002000	4014486491265
	STRAW ELEVATOR DRIVE	344312128	1	1003623	4014486487503
		340435120 K	1	1001468	4014486459784
		LA340433253	1	1000231	4014486520491
		LA340433262	1	1000244	4014486520156
	FAN DRIVE	LA340433405	1	1000554	4014486468472
	FAN RETURN DRIVE	LA340433539	1	1001120	4014486497069
		LA340433984	1	1001346	4014486474596
		LA340433984	1	1001346	4014486474596
	REEL DRIVE VARIABLE SPEED	LA340434138	1	1001061	4014486496451
		LA340435120 K	1	1001468	4014486459784
	FAN DRIVE	LA340435150	1	1001422	4014486459296
		LA340435153	1	1001424	4014486459319
	CHOPPER DRIVE	LA344311151	1	1001717	4014486486995
	HYDRAULIC PUMP DRIVE	LA344311227	1	1001820	4014486488371
	POST CYLINDER VARIATOR DRIVE	LA344311318	1	1002000	4014486491265
	STRAW ELEVATOR DRIVE	LA344312128	1	1003623	4014486487503
<b>L517</b>					
13		340433422	1	1000606	4014486520514
<b>L518</b>					
	DRIVE VARIATOR FRAME	340433132	1	1000101	4014486461022
		340433179	1	1000149	4014486461688
		340433422	1	1000606	4014486520514
<b>L520</b>					
	DRIVE VARIATOR FRAME	340433132	1	1000101	4014486461022
		340433179	1	1000149	4014486461688
		340433422	1	1000606	4014486520514
<b>L521</b>					
13		340433422	1	1000606	4014486520514
<b>L523-INTEGRALE</b>					
		340433132	1	1000101	4014486461022
		340433179	1	1000149	4014486461688
		340433422	1	1000606	4014486520514
<b>L523-MCS</b>					
		340433132	1	1000101	4014486461022
		340433179	1	1000149	4014486461688
		340433422	1	1000606	4014486520514
<b>L524</b>					
13		340433422	1	1000606	4014486520514
<b>L525-INTEGRALE</b>					
		340433132	1	1000101	4014486461022
		340433179	1	1000149	4014486461688
		340433422	1	1000606	4014486520514

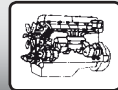

# LAVERDA

## L525-MCS

		340433132	1	1000101	4014486461022
		340433179	1	1000149	4014486461688
		340433422	1	1000606	4014486520514

## L624

13		340433422	1	1000606	4014486520514
----	--	-----------	---	---------	---------------

## L625

		340433132	1	1000101	4014486461022
		340433179	1	1000149	4014486461688
		340433422	1	1000606	4014486520514

## L626

13		340433422	1	1000606	4014486520514
----	--	-----------	---	---------	---------------

## L627-INTEGRALE

		340433132	1	1000101	4014486461022
		340433179	1	1000149	4014486461688
		340433422	1	1000606	4014486520514

## L627-MCS

		340433132	1	1000101	4014486461022
		340433179	1	1000149	4014486461688
		340433422	1	1000606	4014486520514

## M 100

13	BEATER DRUM DRIVE	340435138	1	1004295	4014486683318
----	-------------------	-----------	---	---------	---------------

## M 100 AL

11	REEL DRIVE VARIABLE SPEED	340434140	1	1000999	4014486497229
12	BEATER DRUM DRIVE	340435138	1	1004295	4014486683318

## M 112

1	REEL DRIVE VARIABLE SPEED	340434140	1	1000999	4014486497229
13	STRAW ELEVATOR DRIVE	340433531	1	1000950	4014486474053
14	REEL DRIVE	340433435	1	1000702	4014486470857
17	ROTARY FILTER DRIVE	340433134	1	1003369	4014486461107
17	ROTARY FILTER DRIVE	LA340433134	1	1003369	4014486461107
18	ROTARY FILTER DRIVE	340433162	1	1004273	4014486682878
19	CYLINDER VARIATOR DRIVE	340435146	1	1004271	4014486682861

## M 112 AL

2	STRAW ELEVATOR DRIVE	340433531	1	1000950	4014486474053
9	CENTRAL RETURN DRIVE	340433537	1	1004272	4014486682977
15	ROTARY FILTER DRIVE	340433134	1	1003369	4014486461107
15	ROTARY FILTER DRIVE	LA340433134	1	1003369	4014486461107
16	ROTARY FILTER DRIVE	340433162	1	1004273	4014486682878
17	CYLINDER VARIATOR DRIVE	340435146	1	1004271	4014486682861
18	REEL DRIVE VARIABLE SPEED	340434140	1	1000999	4014486497229

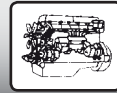
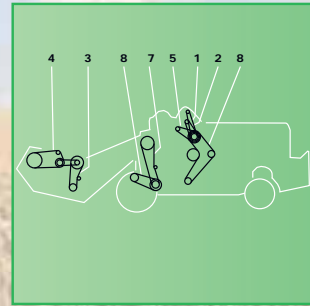
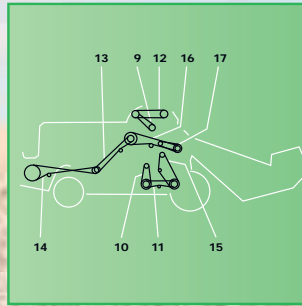
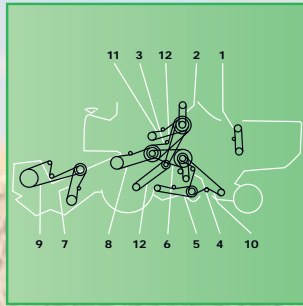
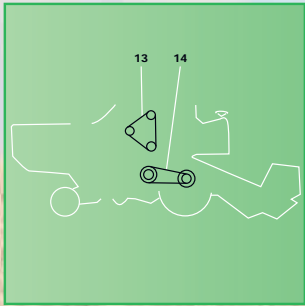

## LAVERDA

M 120					
1	REEL DRIVE	340433435	1	1000702	4014486470857
2	REEL DRIVE VARIABLE SPEED	340434140	1	1000999	4014486497229
3	ELEVATOR DRIVE (UPPER) SHAFT	340433531	1	1000950	4014486474053
7	CENTRAL RETURN DRIVE	340433537	1	1004272	4014486682977
M 132					
1	REEL DRIVE	340433435	1	1000702	4014486470857
2	REEL DRIVE VARIABLE SPEED	340434140	1	1000999	4014486497229
4	STRAW ELEVATOR DRIVE	340433531	1	1000950	4014486474053
9	CENTRAL RETURN DRIVE	340433537	1	1004272	4014486682977
17	ROTARY FILTER RETURN DRIVE	340433134	1	1003369	4014486461107
17	ROTARY FILTER RETURN DRIVE	LA340433134	1	1003369	4014486461107
18	ROTARY FILTER DRIVE	340433162	1	1004273	4014486682878
	ROTARY FILTER RETURN DRIVE	E38713	1	1003369	4014486461107
M 150					
1	REEL DRIVE	340433435	1	1000702	4014486470857
2	REEL DRIVE VARIABLE SPEED	340434140	1	1000999	4014486497229
3	STRAW ELEVATOR DRIVE	340433531	1	1000950	4014486474053
10	CENTRAL RETURN DRIVE	340433537	1	1004272	4014486682977
M 152					
1	REEL DRIVE VARIABLE SPEED	340434140	1	1000999	4014486497229
10	CENTRAL RETURN DRIVE	340433537	1	1004272	4014486682977
13	STRAW ELEVATOR DRIVE	340433531	1	1000950	4014486474053
14	REEL DRIVE	340433435	1	1000702	4014486470857
M 84					
1	FAN DRIVE (GRAIN)	340433131	1	1000106	4014486461091
14	CYLINDER VARIATOR DRIVE (RICE)	340435138	1	1004295	4014486683318
M 90					
12	ELEVATOR DRIVE GRAIN	340433272	1	1003430	4014486464245
M 92					
14	CYLINDER VARI-DRIVE	340435138	1	1004295	4014486683318
MX 240					
		340434138	1	1001061	4014486496451
		LA340434138	1	1001061	4014486496451
MX 240 R					
		340434138	1	1001061	4014486496451
		LA340434138	1	1001061	4014486496451
MX 300					
9	CYLINDER DRIVE	344311127	1	1001637	4014486485868
9	CYLINDER DRIVE	LA344311127	1	1001637	4014486485868
10	CYLINDER DRIVE	344311137	1	1001679	4014486486483
11	HYDRAULIC PUMP DRIVE	344311227	1	1001820	4014486488371
11	HYDRAULIC PUMP DRIVE	LA344311227	1	1001820	4014486488371
		340434138	1	1001061	4014486496451
		LA340434138	1	1001061	4014486496451



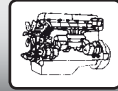

# LAVERDA

## MX 300 R

	340434138	1	1001061	4014486496451
	344311227	1	1001820	4014486488371
	LA340434138	1	1001061	4014486496451
	LA344311227	1	1001820	4014486488371

## MX240

	340433422	1	1000606	4014486520514
--	-----------	---	---------	---------------

## MX240R

	340433422	1	1000606	4014486520514
--	-----------	---	---------	---------------

## MX300

	340433422	1	1000606	4014486520514
--	-----------	---	---------	---------------

## MX300R

	340433422	1	1000606	4014486520514
--	-----------	---	---------	---------------



## MASSEY FERGUSON

<b>24</b>					
5		41958500	1	1000859	4014486472936
9		41955900	1	1000704	4014486470888
13		41935700	1	1003447	4014486465464
14		41988700	1	1003562	4014486473452
15		41926300	1	1000230	4014486463187
16		41930300	1	1003426	4014486464092
<b>27</b>					
8		41934800	3	1002768	4014486465228
10		41929000	1	1000251	4014486463897
10		D41929000	1	1000251	4014486463897
14		41936200	2	1002770	4014486465648
<b>29</b>					
8		41934800	3	1002768	4014486465228
14		41936200	2	1002770	4014486465648
<b>31</b>					
8		41934800	3	1002768	4014486465228
14		41936200	2	1002770	4014486465648
<b>187</b>					
1	TABLE FEEDER DRUM	1724154M1	1	1000647	4014486470079
1	TABLE FEEDER DRUM	417974M1	1	1000651	4014486470116
2	TANK UNLOADER DRIVE	621259M1	1	1000547	4014486468311
3	FANNING MILL (UPPER)	621261M1	1	1000284	4014486464641
4	HYDRAULIC PUMP DRIVE	417468M1	1	1003397	4014486462821
5	BEATER / THRESHER CONTROL	418232M1	1	No AP	
6	FANNING MILL	1721710M1	1	1002096	4014486475890
7	STRAW WALKER SHAKER	621258M1	1	1000346	4014486465983
8	TRACTION (UPPER)	905921M1	1	1004743	4014486720303
9	TRACTION (LOWER)	905920M1	1	1001450	4014486459586
10	REDUCER	417972M1	1	1000885	4014486473261
12	KNIFE - BLADE CONTROL	1722835M1	1	1003502	4014486469097
12	KNIFE DRIVE	402607M1	1	1003515	4014486469653
15	FANNING MILL	621262M1	1	1003334	4014486462586
16	VENTILATOR	621262M1	1	1003334	4014486462586
19	OUTLET	418192M1	1	1000547	4014486468311
<b>206</b>					
1	TABLE FEEDER DRUM	1724154M1	1	1000647	4014486470079
3	FANNING MILL (UPPER)	621261M1	1	1000284	4014486464641
5	BEATER / THRESHER	418232M1	1	No AP	
6	FANNING MILL	1721710M1	1	1002096	4014486475890
7	SHAKER STRAW	621258M1	1	1000346	4014486465983
8	TRACTION (UPPER)	905921M1	1	1004743	4014486720303
9	TRACTION (LOWER)	905920M1	1	1001450	4014486459586
10	REDUCER	417972M1	1	1000885	4014486473261
12	KNIFE - BLADE CONTROL	1722835M1	1	1003502	4014486469097
12	KNIFE DRIVE	402607M1	1	1003515	4014486469653
13	FANNING MILL	621262M1	1	1003334	4014486462586
14	VENTILATION (SECONDARY)	621262M1	1	1003334	4014486462586



## MASSEY FERGUSON

240					
1	TABLE FEEDER DRUM	1724154M1	1	1000647	4014486470079
3	FANNING MILL (UPPER)	621261M1	1	1000284	4014486464641
5	BEATER DRIVE	418232M1	1	No AP	
7	STRAW WALKER SHAKER	621258M1	1	1000346	4014486465983
8	TRACTION (UPPER)	905921M1	1	1004743	4014486720303
9	TRACTION (LOWER)	905920M1	1	1001450	4014486459586
10	REDUCER	417972M1	1	1000885	4014486473261
12	KNIFE DRIVE	1722835M1	1	1003502	4014486469097
12	KNIFE DRIVE	402607M1	1	1003515	4014486469653
12	KNIFE DRIVE	410959M1	1	1003512	4014486469516
13	REEL DRIVE	1604401M1	1	1000370	4014486466331
15	FANNING MILL	621262M1	1	1003334	4014486462586
300					
2	CLEANING FAN DRIVE	832877M1	1	1000232	4014486463262
5	REEL DRIVE VARIABLE SPEED	833768M1	1	1001402	4014486459081
5	REEL DRIVE	834140M1	1	1000734	4014486471281
7	HYDRAULIC PUMP DRIVE	230381M1	1	1003482	4014486468182
8	KNIFE DRIVE	834058M1	1	1000598	4014486469301
8	KNIFE DRIVE	834190M1	1	1000597	4014486469295
10	TRACTION (LOWER) (GRAIN)	832789M3	1	1001442	4014486459500
12	REEL DRIVE COUNTERSHAFT	834139M1	1	1000567	4014486468748
18	TANK UNLOADER DRIVE	832878M1	1	1000596	4014486469257
	AUGER (GRAIN)	227984M1	1	1000731	4014486471250
	AIR CONDITIONING OR CLEAN FAN HIGH SPEED	834492M2	1	1000211	4014486462593
307					
1	TABLE FEEDER DRUM	1724154M1	1	1000647	4014486470079
3	FANNING MILL (UPPER)	621261M1	1	1000284	4014486464641
5	BEATER / THRESHER	1603701M1	1	1001641	4014486485936
5	BEATER / THRESHER	1720255M1	1	1001871	4014486489125
6	FANNING MILL / VARIATOR	621262M1	1	1003334	4014486462586
7	STRAW WALKER SHAKER	621258M1	1	1000346	4014486465983
8	TRACTION (LOWER)	905921M1	1	1004743	4014486720303
9	TRACTION (UPPER)	905920M1	1	1001450	4014486459586
10	CONTROL REDUCER UP TO 8.5 FEET / BAR	417972M1	1	1000885	4014486473261
12	KNIFE WOBBLE DRIVE	1722835M1	1	1003502	4014486469097
12	KNIFE UP TO 8.5 FEET (2.5 M)	402607M1	1	1003515	4014486469653
12	KNIFE FROM 10 FEET (2.2 M)	410959M1	1	1003512	4014486469516
13	REEL DRIVE	1604401M1	1	1000370	4014486466331
15	FANNING MILL	621262M1	1	1003334	4014486462586
400					
1	FANNING MILL	784797M2	1	1000214	4014486462708
3	FANNING MILL (UPPER)	1855008M1	1	1000572	4014486468809
5	HYDRAULIC PUMP DRIVE	832490M1	1	1001277	4014486474435
6	ALTERNATOR DRIVE	893575M1	1	1000060	4014486483802
7	DRIVE	793863M1	1	No AP	
10	RETURN DRIVE	795514M4	1	1000264	4014486464214
10	RETURN DRIVE	832538M1	1	1003431	4014486464313
11	SHAKER SHAFT DRIVE	1615254M1	1	1000765	4014486471687
11	SHAKER SHAFT DRIVE	320593M2	1	1001361	4014486474756
12	ELEVATOR DRIVE GRAIN	784796M2	1	1003546	4014486471243

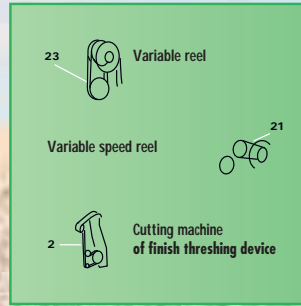
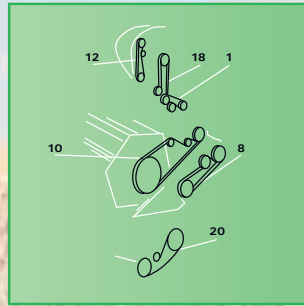
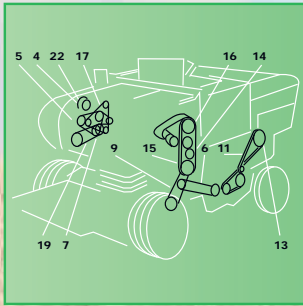

## MASSEY FERGUSON

15	REDUCER	789853M1	1	1001403	4014486459098
17	REEL DRIVE	1615333M1	1	1000743	4014486471397
17	REEL DRIVE	785810M1	1	1000378	4014486466416
<b>440</b>					
1	TABLE FEEDER DRUM	621588M1	1	1000668	4014486470352
3	FANNING MILL (UPPER)	621261M1	1	1000284	4014486464641
5	BEATER DRIVE	1720255M1	1	1001871	4014486489125
8	TRACTION (UPPER)	905921M1	1	1004743	4014486720303
9	TRACTION (LOWER)	905920M1	1	1001450	4014486459586
12	KNIFE DRIVE	410959M1	1	1003512	4014486469516
13	REEL DRIVE	1604401M1	1	1000370	4014486466331
15	FANNING MILL	621262M1	1	1003334	4014486462586
<b>487</b>					
2	VENTILATOR	621262M1	1	1003334	4014486462586
5	DEFLECTOR DRUM	1720255M1	1	1001871	4014486489125
6	OUTLET GRAIN	418192M1	1	1000547	4014486468311
7	BAR CONTROL	621588M1	1	1000668	4014486470352
<b>500</b>					
1	FANNING MILL	784797M2	1	1000214	4014486462708
3	FANNING MILL (UPPER)	1855008M1	1	1000572	4014486468809
5	HYDRAULIC PUMP DRIVE	230381M1	1	1003482	4014486468182
6	ALTERNATOR DRIVE	893575M1	1	1000060	4014486483802
7	DRIVE	793863M1	1	No AP	
10	RETURN DRIVE	832538M1	1	1003431	4014486464313
11	SHAKER SHAFT DRIVE	320593M2	1	1001361	4014486474756
12	ELEVATOR DRIVE GRAIN	784796M2	1	1003546	4014486471243
<b>507</b>					
2	VENTILATOR	621262M1	1	1003334	4014486462586
3	VENTILATOR	621261M1	1	1000284	4014486464641
4	STRAW SHAKER	621258M1	1	1000346	4014486465983
5	OUTLET GRAIN	905980M1	1	1001552	4014486484519
6	DEFLECTOR DRUM	1720205M3	1	1001889	4014486489460
7	BLADE CONTROL	410959M1	1	1003512	4014486469516
8	BAR CONTROL	621588M1	1	1000668	4014486470352
9	HYDRAULIC PUMP DRIVE	1720674M2	1	1000220	4014486462838
<b>510</b>					
1	FANNING MILL	784797M2	1	1000214	4014486462708
3	FANNING MILL (UPPER)	1855008M1	1	1000572	4014486468809
5	HYDRAULIC PUMP DRIVE	230381M1	1	1003482	4014486468182
6	ALTERNATOR DRIVE	893575M1	1	1000060	4014486483802
7	DRIVE	793863M1	1	No AP	
10	RETURN DRIVE	795514M4	1	1000264	4014486464214
10	RETURN DRIVE	795582M2	1	1000249	4014486463828
11	SHAKER SHAFT DRIVE	1615254M1	1	1000765	4014486471687
12	ELEVATOR DRIVE GRAIN	784796M2	1	1003546	4014486471243
16	KNIFE DRIVE	785585M3	1	1004096	4014486518696
17	REEL DRIVE	1615254M1	1	1000765	4014486471687
17	REEL DRIVE	1615333M1	1	1000743	4014486471397

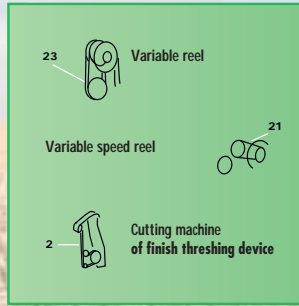
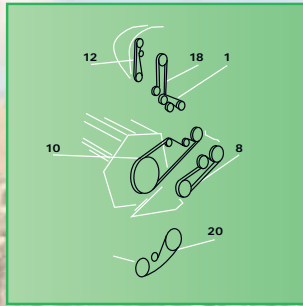
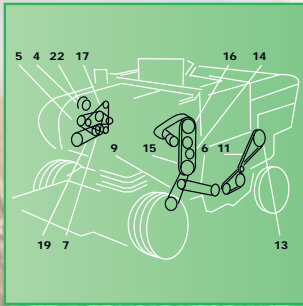

# MASSEY FERGUSON

515					
1	FANNING MILL	784797M2	1	1000214	4014486462708
3	FANNING MILL (UPPER)	1855008M1	1	1000572	4014486468809
5	HYDRAULIC PUMP DRIVE	230381M1	1	1003482	4014486468182
6	ALTERNATOR DRIVE	893575M1	1	1000060	4014486483802
7	DRIVE	793863M1	1	No AP	
10	RETURN DRIVE	795514M4	1	1000264	4014486464214
10	RETURN DRIVE	795582M2	1	1000249	4014486463828
11	SHAKER SHAFT DRIVE	1615254M1	1	1000765	4014486471687
12	ELEVATOR DRIVE GRAIN	784796M2	1	1003546	4014486471243
16	KNIFE DRIVE	785585M3	1	1004096	4014486518696
17	REEL DRIVE	1615254M1	1	1000765	4014486471687
17	REEL DRIVE	1615333M1	1	1000743	4014486471397
520					
1	FANNING MILL	1616477M1	1	1000211	4014486462593
1	FANNING MILL	784797M2	1	1000214	4014486462708
2	TANK UNLOADER DRIVE	619317M2	1	1000563	4014486468656
3	FANNING MILL (UPPER)	785585M3	1	1004096	4014486518696
3	FANNING MILL (UPPER)	789853M1	1	1001403	4014486459098
6	ALTERNATOR DRIVE	893575M1	1	1000060	4014486483802
7	DRIVE	789967M1	1	1000986	4014486498066
8	MAIN BELT	789930M1	1	1002617	4014486498080
9	MULTI FLOW	784170M2	1	1000425	4014486466881
10	RETURN DRIVE	795514M4	1	1000264	4014486464214
10	RETURN DRIVE	795582M2	1	1000249	4014486463828
11	SHAKER SHAFT DRIVE	1615254M1	1	1000765	4014486471687
12	ELEVATOR DRIVE GRAIN	784796M2	1	1003546	4014486471243
15	REDUCER	789853M1	1	1001403	4014486459098
16	KNIFE DRIVE	785585M3	1	1004096	4014486518696
17	REEL DRIVE	1615333M1	1	1000743	4014486471397
17	REEL DRIVE	785810M1	1	1000378	4014486466416
525					
1	FANNING MILL	1616477M1	1	1000211	4014486462593
1	FANNING MILL	784797M2	1	1000214	4014486462708
2	TANK UNLOADER DRIVE	619317M2	1	1000563	4014486468656
3	FANNING MILL (UPPER)	785585M3	1	1004096	4014486518696
3	FANNING MILL (UPPER)	789853M1	1	1001403	4014486459098
6	ALTERNATOR DRIVE	893575M1	1	1000060	4014486483802
7	DRIVE	789967M1	1	1000986	4014486498066
8	MAIN BELT	789930M1	1	1002617	4014486498080
9	MULTI FLOW	784170M2	1	1000425	4014486466881
10	RETURN DRIVE	795514M4	1	1000264	4014486464214
10	RETURN DRIVE	795582M2	1	1000249	4014486463828
11	SHAKER SHAFT DRIVE	1615254M1	1	1000765	4014486471687
12	ELEVATOR DRIVE GRAIN	784796M2	1	1003546	4014486471243
15	REDUCER	789853M1	1	1001403	4014486459098
16	KNIFE DRIVE	785585M3	1	1004096	4014486518696
17	REEL DRIVE	1615333M1	1	1000743	4014486471397
17	REEL DRIVE	785810M1	1	1000378	4014486466416

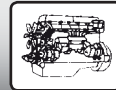
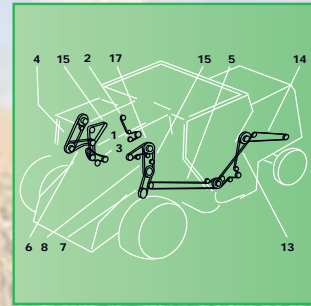
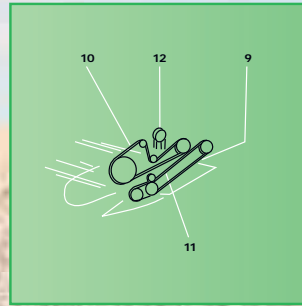
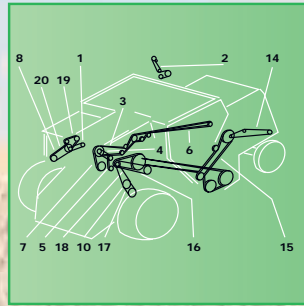
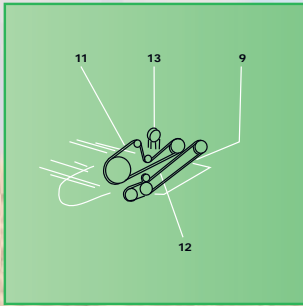

## MASSEY FERGUSON

### 530

1	FANNING MILL	784797M2	1	1000214	4014486462708
2	TANK UNLOADER DRIVE	3370141M1	1	1001746	4014486487305
3	FANNING MILL (UPPER)	785585M3	1	1004096	4014486518696
8	MAIN BELT	789930M1	1	1002617	4014486498080
9	MULTI FLOW	795582M2	1	1000249	4014486463828
10	RETURN DRIVE	795514M4	1	1000264	4014486464214
11	SHAKER SHAFT DRIVE	1615254M1	1	1000765	4014486471687
12	ELEVATOR DRIVE GRAIN	784796M2	1	1003546	4014486471243
16	KNIFE DRIVE	1724154M1	1	1000647	4014486470079
17	REEL DRIVE	843313M1	1	1001016	4014486497991

### 535

1	FANNING MILL	784797M2	1	1000214	4014486462708
2	TANK UNLOADER DRIVE	3370141M1	1	1001746	4014486487305
3	FANNING MILL (UPPER)	785585M3	1	1004096	4014486518696
8	MAIN BELT	789930M1	1	1002617	4014486498080
9	MULTI FLOW	795582M2	1	1000249	4014486463828
10	RETURN DRIVE	795514M4	1	1000264	4014486464214
11	SHAKER SHAFT DRIVE	1615254M1	1	1000765	4014486471687
12	ELEVATOR DRIVE GRAIN	784796M2	1	1003546	4014486471243
16	KNIFE DRIVE	1724154M1	1	1000647	4014486470079
17	REEL DRIVE	843313M1	1	1001016	4014486497991

### 540

1	AIR CONDITIONING COMPRESSOR DRIVE	843045M1	1	1002543	4014486494723
2	AUXILIARY CYLINDER (SLINGER)	834332M1	1	1000304	4014486465075
3	CHOPPER DRIVE - HIGH SPEED	843760M1	1	1000803	4014486472233
4	CLEANING FAN DRIVE	832877M1	1	1000232	4014486463262
8	AIR INTAKE DRIVE	240575M2	1	1002298	4014486479867
9	KNIFE WOBBLE - FLOATING CUT BAR	833962M1	1	1000673	4014486470444
9	KNIFE WOBBLE - RIGID CUT BAR	834190M1	1	1000597	4014486469295
10	BEATER (REAR)OR STRAW CHOPPER	843747M1	1	1000827	4014486472547
11	REEL DRIVE	834140M1	1	1000734	4014486471281
12	REEL DRIVE COUNTERSHAFT	834139M1	1	1000567	4014486468748
13	REEL DRIVE VARIABLE SPEED	833768M1	1	1001402	4014486459081
16	TANK UNLOADER DRIVE	832878M1	1	1000596	4014486469257
17	TRACTION (LOWER)	843732M2	1	1001443	4014486459517
18	TRACTION (UPPER)	844091M1	1	1001445	4014486459531
19	ALTERNATOR, FAN AND WATERPUMP DRIVE	532779M92	2	1002480	4014486493740
20	HYDRAULIC PUMP DRIVE	230380M1	1	1000541	4014486468236

### 550

1	CLEANING FAN - COUNTERSHAFT	227457M1	1	1000572	4014486468809
2	AUXILIARY CYLINDER (SLINGER)	834332M1	1	1000304	4014486465075
3	CLEANING FAN DRIVE	227976M1	1	1000214	4014486462708
3	CLEANING FAN - HIGH SPEED	834492M2	1	1000211	4014486462593
5	AUGER (GRAIN)	227984M1	1	1000731	4014486471250
6	HYDRAULIC PUMP DRIVE	843737M1	1	1000216	4014486462777
7	HYDROSTATIC DRIVE (LOWER)	834176M1	1	1003627	4014486488159
8	HYDROSTATIC DRIVE (UPPER)	834175M1	1	1001842	4014486488715
9	KNIFE WOBBLE - FLOATING CUT BAR	833962M1	1	1000673	4014486470444
9	KNIFE WOBBLE - CENTERED CHAIN DRIVE	834058M1	1	1000598	4014486469301
9	KNIFE WOBBLE - RIGID CUT BAR	834190M1	1	1000597	4014486469295

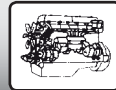

## MASSEY FERGUSON

10	REEL DRIVE	834140M1	1	1000734	4014486471281
11	REEL DRIVE COUNTERSHAFT	834139M1	1	1000567	4014486468748
12	REEL DRIVE VARIABLE SPEED	833768M1	1	1001402	4014486459081
13	RETURN AUGER AND WALKER	227986M2	1	1000402	4014486466652
15	TANK UNLOADER DRIVE	228813M3	1	1000543	4014486468250
16	ALTERNATOR, FAN AND WATERPUMP DRIVE	532779M92	2	1002480	4014486493740
	CHOPPER DRIVE	1051235M1	1	1000878	4014486473186
	STRAW CHOPPER CORN KIT - LOW SPEED	842935M1	1	1003482	4014486468182

### 560

1	FANNING MILL	3043153M1	1	1001399	4014486459050
1	FANNING MILL	3043154M1	1	1001398	4014486459043
2	TANK UNLOADER DRIVE	3370141M1	1	1001746	4014486487305
3	FANNING MILL (UPPER)	785585M3	1	1004096	4014486518696
5	HYDRAULIC PUMP DRIVE	843313M1	1	1001016	4014486497991
6	ALTERNATOR DRIVE	1687531M1	1	1002558	4014486495034
7	DRIVE	789967M1	1	1000986	4014486498066
8	MAIN BELT	789930M1	1	1002617	4014486498080
8	MAIN BELT	789931M1	1	1002616	4014486498073
10	RETURN DRIVE	795514M4	1	1000264	4014486464214
10	RETURN DRIVE	795582M2	1	1000249	4014486463828
11	SHAKER SHAFT DRIVE	1615254M1	1	1000765	4014486471687
12	ELEVATOR DRIVE GRAIN	784796M2	1	1003546	4014486471243
15	REDUCER	789853M1	1	1001403	4014486459098
16	KNIFE DRIVE	1724154M1	1	1000647	4014486470079
17	REEL DRIVE	843313M1	1	1001016	4014486497991

### 565

1	FANNING MILL	3043153M1	1	1001399	4014486459050
1	FANNING MILL	3043154M1	1	1001398	4014486459043
2	TANK UNLOADER DRIVE	3370141M1	1	1001746	4014486487305
3	FANNING MILL (UPPER)	785585M3	1	1004096	4014486518696
5	HYDRAULIC PUMP DRIVE	843313M1	1	1001016	4014486497991
6	ALTERNATOR DRIVE	1687531M1	1	1002558	4014486495034
7	DRIVE	789967M1	1	1000986	4014486498066
8	MAIN BELT	789930M1	1	1002617	4014486498080
8	MAIN BELT	789931M1	1	1002616	4014486498073
10	RETURN DRIVE	795514M4	1	1000264	4014486464214
10	RETURN DRIVE	795582M2	1	1000249	4014486463828
11	SHAKER SHAFT DRIVE	1615254M1	1	1000765	4014486471687
12	ELEVATOR DRIVE GRAIN	784796M2	1	1003546	4014486471243
15	REDUCER	789853M1	1	1001403	4014486459098
16	KNIFE DRIVE	1724154M1	1	1000647	4014486470079
17	REEL DRIVE	843313M1	1	1001016	4014486497991

### 620

1	FANNING MILL	1616477M1	1	1000211	4014486462593
1	FANNING MILL	784797M2	1	1000214	4014486462708
2	TANK UNLOADER DRIVE	619317M2	1	1000563	4014486468656
3	FANNING MILL (UPPER)	785585M3	1	1004096	4014486518696
3	FANNING MILL (UPPER)	789853M1	1	1001403	4014486459098
6	ALTERNATOR DRIVE	893575M1	1	1000060	4014486483802
7	DRIVE	789967M1	1	1000986	4014486498066
8	MAIN BELT	789930M1	1	1002617	4014486498080
9	MULTI FLOW	784170M2	1	1000425	4014486466881



## MASSEY FERGUSON

10	RETURN DRIVE	795514M4	1	1000264	4014486464214
10	RETURN DRIVE	795582M2	1	1000249	4014486463828
11	SHAKER SHAFT DRIVE	1615254M1	1	1000765	4014486471687
12	ELEVATOR DRIVE GRAIN	784796M2	1	1003546	4014486471243
15	REDUCER	789853M1	1	1001403	4014486459098
16	KNIFE DRIVE	785585M3	1	1004096	4014486518696
17	REEL DRIVE	1615333M1	1	1000743	4014486471397
17	REEL DRIVE	785810M1	1	1000378	4014486466416

### 625

1	FANNING MILL	1616477M1	1	1000211	4014486462593
1	FANNING MILL	784797M2	1	1000214	4014486462708
2	TANK UNLOADER DRIVE	619317M2	1	1000563	4014486468656
3	FANNING MILL (UPPER)	785585M3	1	1004096	4014486518696
3	FANNING MILL (UPPER)	789853M1	1	1001403	4014486459098
6	ALTERNATOR DRIVE	893575M1	1	1000060	4014486483802
7	DRIVE	789967M1	1	1000986	4014486498066
8	MAIN BELT	789930M1	1	1002617	4014486498080
9	MULTI FLOW	784170M2	1	1000425	4014486466881
10	RETURN DRIVE	795514M4	1	1000264	4014486464214
10	RETURN DRIVE	795582M2	1	1000249	4014486463828
11	SHAKER SHAFT DRIVE	1615254M1	1	1000765	4014486471687
12	ELEVATOR DRIVE GRAIN	784796M2	1	1003546	4014486471243
15	REDUCER	789853M1	1	1001403	4014486459098
16	KNIFE DRIVE	785585M3	1	1004096	4014486518696
17	REEL DRIVE	1615333M1	1	1000743	4014486471397
17	REEL DRIVE	785810M1	1	1000378	4014486466416

### 660

1	FANNING MILL	3043153M1	1	1001399	4014486459050
1	FANNING MILL	3043154M1	1	1001398	4014486459043
2	TANK UNLOADER DRIVE	3370141M1	1	1001746	4014486487305
3	FANNING MILL (UPPER)	785585M3	1	1004096	4014486518696
5	HYDRAULIC PUMP DRIVE	843313M1	1	1001016	4014486497991
6	ALTERNATOR DRIVE	1687531M1	1	1002558	4014486495034
7	DRIVE	789967M1	1	1000986	4014486498066
8	MAIN BELT	789930M1	1	1002617	4014486498080
8	MAIN BELT	789931M1	1	1002616	4014486498073
10	RETURN DRIVE	795514M4	1	1000264	4014486464214
10	RETURN DRIVE	795582M2	1	1000249	4014486463828
11	SHAKER SHAFT DRIVE	1615254M1	1	1000765	4014486471687
12	ELEVATOR DRIVE GRAIN	784796M2	1	1003546	4014486471243
15	REDUCER	789853M1	1	1001403	4014486459098
16	KNIFE DRIVE	1724154M1	1	1000647	4014486470079
17	REEL DRIVE	843313M1	1	1001016	4014486497991

### 665

1	FANNING MILL	3043153M1	1	1001399	4014486459050
1	FANNING MILL	3043154M1	1	1001398	4014486459043
2	TANK UNLOADER DRIVE	3370141M1	1	1001746	4014486487305
3	FANNING MILL (UPPER)	785585M3	1	1004096	4014486518696
5	HYDRAULIC PUMP DRIVE	843313M1	1	1001016	4014486497991
6	ALTERNATOR DRIVE	1687531M1	1	1002558	4014486495034
7	DRIVE	789967M1	1	1000986	4014486498066
8	MAIN BELT	789930M1	1	1002617	4014486498080



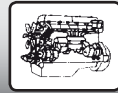

## MASSEY FERGUSON

8	MAIN BELT	789931M1	1	1002616	4014486498073
10	RETURN DRIVE	795514M4	1	1000264	4014486464214
10	RETURN DRIVE	795582M2	1	1000249	4014486463828
11	SHAKER SHAFT DRIVE	1615254M1	1	1000765	4014486471687
12	ELEVATOR DRIVE GRAIN	784796M2	1	1003546	4014486471243
15	REDUCER	789853M1	1	1001403	4014486459098
16	KNIFE DRIVE	1724154M1	1	1000647	4014486470079
17	REEL DRIVE	843313M1	1	1001016	4014486497991
<b>750</b>					
1	HYDRAULIC PUMP DRIVE (MECHANICAL SERIAL NR. 5387 - ...)	222882M2	1	1000232	4014486463262
2	RADIATOR FAN (MECHANICAL SERIAL NR. 1979-5387)	259047M91	2	1000131	4014486461473
2	RADIATOR FAN DRIVE	265522M91	2	1000133	4014486461497
4	AIR CONDITIONING COMPRESSOR DRIVE	1686883M1	1	1002534	4014486494556
4	AIR CONDITIONING COMPRESSOR DRIVE (SERIAL NR. 9674 - ...)	834492M2	1	1000211	4014486462593
4	AIR CONDITIONING COMPRESSOR DRIVE (SERIAL NR. 9674 - ...)	843045M1	1	1002543	4014486494723
5	MAIN DRIVE	833874M1	1	1001848	4014486488791
7	RETURN ELEVATOR DRIVE	833854M2	1	1000335	4014486465754
8	CYLINDER	833868M2	1	1001483	4014486459937
10	STRAW CHOPPER (SERIAL NR. ... - 16539)	833871M1	1	1001747	4014486485417
10	STRAW CHOPPER (SERIAL NR. 16539 - ...)	843948M1	1	1001451	4014486459593
11	STRAW CHOPPER (SERIAL NR. 16539 - ...)	843747M1	1	1000827	4014486472547
12	STRAW CHOPPER DRIVE (SERIAL NR. 16539 - ...)	832906M1	1	1000758	4014486471595
12	STRAW CHOPPER DRIVE (SERIAL NR. ... - 16539)	833872M1	1	1000762	4014486471632
12	STRAW CHOPPER DRIVE	843760M1	1	1000803	4014486472233
14	STRAW WALKER DRIVE	833855M1	1	1000419	4014486466829
14	STRAW WALKER DRIVE	843310M1	1	1000429	4014486466935
15	SHAKER SHOE DRIVE	273757M91	2	1000381	4014486466447
16	SHAKER SHOE - COUNTERSHAFT - FAN (SERIAL NR. ... - 15716)	274015M91	1	1003436	4014486464795
16	SHAKER SHOE - COUNTERSHAFT - FAN (SERIAL NR. 15716 - ...)	281560M91	2	1002782	4014486464832
17	CLEANING FAN DRIVE	833863M1	1	1001400	4014486459067
18	TRACTION (UPPER)	833856M1	1	No AP	
18	TRACTION (UPPER)	833858M4	1	No AP	
18	HYDROSTATIC TRACTION DRIVE (UPPER)	844077M1	1	No AP	
19	TRACTION (LOWER)	833858M4	1	No AP	
20	REEL DRIVE	834140M1	1	1000734	4014486471281
21	REEL DRIVE VARIABLE SPEED	833768M1	1	1001402	4014486459081
22	KNIFE WOBBLE DRIVE	834190M1	1	1000597	4014486469295
22	WOBBLE BOX DRIVE	842809M1	1	1000700	4014486470833
23	REEL DRIVE COUNTERSHAFT	834139M1	1	1000567	4014486468748
24	DISCHARGE DRIVE GRAIN TANK	833873M1	1	1001568	4014486484717
<b>755</b>					
1	HYDRAULIC PUMP DRIVE (MECHANICAL SERIAL NR. 5387 - ...)	222882M2	1	1000232	4014486463262
2	RADIATOR FAN (MECHANICAL SERIAL NR. 1979-5387)	259047M91	2	1000131	4014486461473
2	RADIATOR FAN DRIVE	265522M91	2	1000133	4014486461497
4	AIR CONDITIONING COMPRESSOR DRIVE	1686883M1	1	1002534	4014486494556
4	AIR CONDITIONING COMPRESSOR DRIVE (SERIAL NR. 9674 - ...)	834492M2	1	1000211	4014486462593
4	AIR CONDITIONING COMPRESSOR DRIVE (SERIAL NR. 9674 - ...)	843045M1	1	1002543	4014486494723
5	MAIN DRIVE	833874M1	1	1001848	4014486488791
7	RETURN ELEVATOR DRIVE	833854M2	1	1000335	4014486465754
8	CYLINDER	833868M2	1	1001483	4014486459937
10	STRAW CHOPPER (SERIAL NR. ... - 16539)	833871M1	1	1001747	4014486485417
10	STRAW CHOPPER (SERIAL NR. 16539 - ...)	843948M1	1	1001451	4014486459593
11	STRAW CHOPPER (SERIAL NR. 16539 - ...)	843747M1	1	1000827	4014486472547

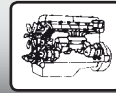
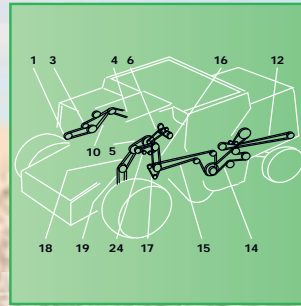
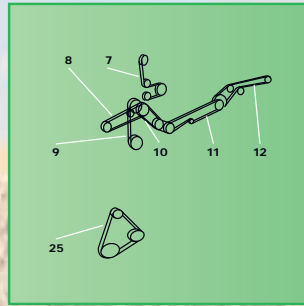
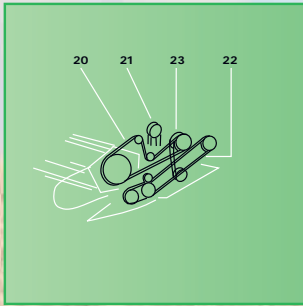

## MASSEY FERGUSON

12	STRAW CHOPPER DRIVE (SERIAL NR. 16539 - ...)	832906M1	1	1000758	4014486471595
12	STRAW CHOPPER DRIVE (SERIAL NR. ... - 16539)	833872M1	1	1000762	4014486471632
12	STRAW CHOPPER DRIVE	843760M1	1	1000803	4014486472233
14	STRAW WALKER DRIVE	833855M1	1	1000419	4014486466829
14	STRAW WALKER DRIVE	843310M1	1	1000429	4014486466935
15	SHAKER SHOE DRIVE	273757M91	2	1000381	4014486466447
16	SHAKER SHOE - COUNTERSHAFT - FAN (SERIAL NR. ... - 15716)	274015M91	1	1003436	4014486464795
16	SHAKER SHOE - COUNTERSHAFT - FAN (SERIAL NR. 15716 - ...)	281560M91	2	1002782	4014486464832
17	CLEANING FAN DRIVE	833863M1	1	1001400	4014486459067
18	TRACTION (UPPER)	833856M1	1	No AP	
18	TRACTION (UPPER)	833858M4	1	No AP	
18	HYDROSTATIC TRACTION DRIVE (UPPER)	844077M1	1	No AP	
19	TRACTION (LOWER)	833858M4	1	No AP	
20	REEL DRIVE	834140M1	1	1000734	4014486471281
21	REEL DRIVE VARIABLE SPEED	833768M1	1	1001402	4014486459081
22	KNIFE WOBBLE DRIVE	834190M1	1	1000597	4014486469295
22	WOBBLE BOX DRIVE	842809M1	1	1000700	4014486470833
23	REEL DRIVE COUNTERSHAFT	834139M1	1	1000567	4014486468748
24	DISCHARGE DRIVE GRAIN TANK	833873M1	1	1001568	4014486484717

### 760

1	REEL DRIVE	834139M1	1	1000567	4014486468748
2	SELECTOR	834058M1	1	1000598	4014486469301
3	REEL DRIVE	834140M1	1	1000734	4014486471281
5	ALTERNATOR DRIVE II	273837M91	1	1002490	4014486493931
7	AIR ASPIRATOR	833867M1	1	1000119	4014486461305
9	FAN DRIVE	274339M91	1	1000128	4014486461428
10	STRAW CUTTER	833871M1	1	1001747	4014486485417
11	CENTRAL TRANSMISSION	833865M1	1	1003665	4014486490879
12	AIR CONDITIONING COMPRESSOR DRIVE	834492M2	1	1000211	4014486462593
14	VENTILATOR	274015M91	1	1003436	4014486464795
15	ELEVATOR DRIVE UNIT	833854M2	1	1000335	4014486465754
16	BEATER DRIVE	273757M91	2	1000381	4014486466447
18	STRAW CUTTER	833872M1	1	1000762	4014486471632
19	STRAW SHAKER	833860M1	1	1000820	4014486472462
22	VENTILATOR	833863M1	1	1001400	4014486459067

### 850

2	RADIATOR FAN DRIVE	265522M91	2	1000133	4014486461497
4	AIR CONDITIONING COMPRESSOR DRIVE	3386214M1	1	1002542	4014486494709
4	AIR CONDITIONING COMPRESSOR DRIVE	521110M1	1	1002531	4014486494501
4	AIR CONDITIONING COMPRESSOR DRIVE (SERIAL NR. ... - 25658)	529964M1	1	1002534	4014486494556
5	MAIN DRIVE - 3 BAND	833874M1	1	1001848	4014486488791
7	RETURN ELEVATOR DRIVE	833854M2	1	1000335	4014486465754
8	CYLINDER DRIVE	833868M2	1	1001483	4014486459937
10	STRAW CHOPPER (FRONT)	843948M1	1	1001451	4014486459593
11	STRAW CHOPPER (CENTER)	843747M1	1	1000827	4014486472547
12	STRAW CHOPPER (REAR)	843760M1	1	1000803	4014486472233
14	STRAW WALKER DRIVE	843310M1	1	1000429	4014486466935
15	SHAKER SHOE DRIVE	273757M91	2	1000381	4014486466447
17	CLEANING FAN DRIVE	833863M1	1	1001400	4014486459067
18	TRACTION (UPPER) - 4 SPEED	833858M4	1	No AP	
18	HYDROSTATIC TRACTION DRIVE (UPPER)	844077M1	1	No AP	
21	TANK UNLOADER DRIVE	833873M1	1	1001568	4014486484717
23	WOBBLE BOX - FLOATING CUT BAR 22 FEET	227455M1	1	1000698	4014486470802

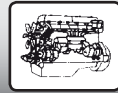
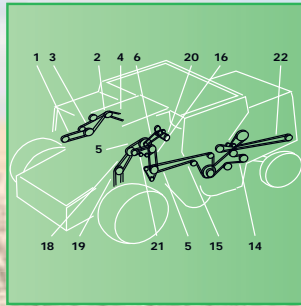
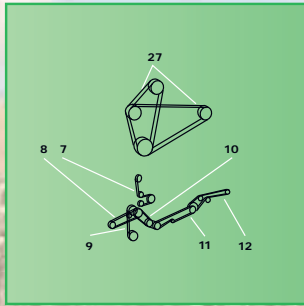
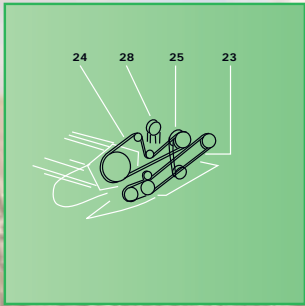

## MASSEY FERGUSON

23	WOBBLE BOX - FLOATING CUT BAR 15 FEET - 20 FEET	833962M1	1	1000673	4014486470444
23	WOBBLE BOX - RIGID CUT BAR 15 FEET - 20 FEET TABLE	834190M1	1	1000597	4014486469295
24	REEL DRIVE	834140M1	1	1000734	4014486471281
25	REEL DRIVE COUNTERSHAFT	834139M1	1	1000567	4014486468748
26	REEL DRIVE VARIABLE SPEED	833768M1	1	1001402	4014486459081
<b>855</b>					
2	RADIATOR FAN DRIVE	265522M91	2	1000133	4014486461497
4	AIR CONDITIONING COMPRESSOR DRIVE	3386214M1	1	1002542	4014486494709
4	AIR CONDITIONING COMPRESSOR DRIVE	521110M1	1	1002531	4014486494501
4	AIR CONDITIONING COMPRESSOR DRIVE (SERIAL NR. ... - 25658)	529964M1	1	1002534	4014486494556
5	MAIN DRIVE - 3 BAND	833874M1	1	1001848	4014486488791
7	RETURN ELEVATOR DRIVE	833854M2	1	1000335	4014486465754
8	CYLINDER DRIVE	833868M2	1	1001483	4014486459937
10	STRAW CHOPPER (FRONT)	843948M1	1	1001451	4014486459593
11	STRAW CHOPPER (CENTER)	843747M1	1	1000827	4014486472547
12	STRAW CHOPPER (REAR)	843760M1	1	1000803	4014486472233
14	STRAW WALKER DRIVE	843310M1	1	1000429	4014486466935
15	SHAKER SHOE DRIVE	273757M91	2	1000381	4014486466447
17	CLEANING FAN DRIVE	833863M1	1	1001400	4014486459067
18	TRACTION (UPPER) - 4 SPEED	833858M4	1	No AP	
18	HYDROSTATIC TRACTION DRIVE (UPPER)	844077M1	1	No AP	
21	TANK UNLOADER DRIVE	833873M1	1	1001568	4014486484717
23	WOBBLE BOX - FLOATING CUT BAR 22 FEET	227455M1	1	1000698	4014486470802
23	WOBBLE BOX - FLOATING CUT BAR 15 FEET - 20 FEET	833962M1	1	1000673	4014486470444
23	WOBBLE BOX - RIGID CUT BAR 15 FEET - 20 FEET TABLE	834190M1	1	1000597	4014486469295
24	REEL DRIVE	834140M1	1	1000734	4014486471281
25	REEL DRIVE COUNTERSHAFT	834139M1	1	1000567	4014486468748
26	REEL DRIVE VARIABLE SPEED	833768M1	1	1001402	4014486459081
<b>860</b>					
2	RADIATOR AND FAN DRIVE (SERIAL NR. ... - 16559)	259047M91	2	1000131	4014486461473
2	RADIATOR AND FAN DRIVE (SERIAL NR. 15558 - ...)	284633M91	2	1003757	4014486461459
4	AIR CONDITIONING COMPRESSOR DRIVE	529964M1	1	1002534	4014486494556
5	MAIN DRIVE	833865M1	1	1003665	4014486490879
6	ROTARY SCREEN - COUNTERSHAFT	833867M1	1	1000119	4014486461305
7	RETURN ELEVATOR DRIVE	833854M2	1	1000335	4014486465754
10	STRAW CHOPPER (FRONT)	843948M1	1	1001451	4014486459593
11	STRAW CHOPPER (CENTER)	843747M1	1	1000827	4014486472547
12	STRAW CHOPPER (REAR) 102.5 INCH	843760M1	1	1000803	4014486472233
15	SHAKER SHOE DRIVE	273757M91	2	1000381	4014486466447
17	CLEANING FAN DRIVE	833863M1	1	1001400	4014486459067
18	TRACTION (UPPER) - 4 SPEED	833858M4	1	No AP	
19	TRACTION (LOWER) - 4 SPEED (SERIAL NR. ... - 19115)	833858M4	1	No AP	
20	COUNTERSHAFT - ROTARY SCREEN	844306M1	1	1000116	4014486461251
21	TANK UNLOADER DRIVE	833862M3	1	1003597	4014486485059
22	WOBBLE BOX - FLOATING CUT BAR 22 FEET	227455M1	1	1000698	4014486470802
22	WOBBLE BOX - FLOATING CUT BAR 22 FEET	832832M1	1	1000688	4014486470680
22	WOBBLE BOX - FLOATING CUT BAR 15 FEET - 20 FEET	833962M1	1	1000673	4014486470444
23	WOBBLE BOX DRIVE	834190M1	1	1000597	4014486469295
23	DRAPER TABLE	842809M1	1	1000700	4014486470833
24	REEL DRIVE	834140M1	1	1000734	4014486471281
25	REEL DRIVE COUNTERSHAFT	834139M1	1	1000567	4014486468748

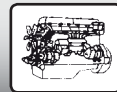
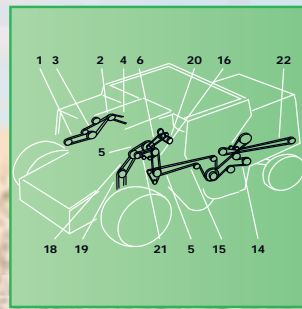
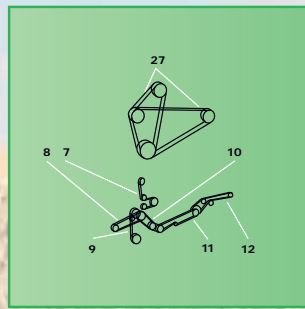
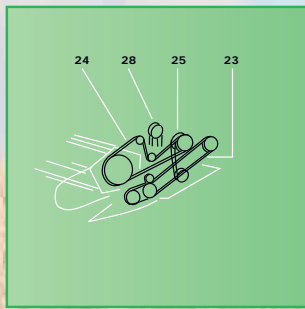

## MASSEY FERGUSON

### 865

2	RADIATOR AND FAN DRIVE (SERIAL NR. ... - 16559)	259047M91	2	1000131	4014486461473
2	RADIATOR AND FAN DRIVE (SERIAL NR. 15558 - ...)	284633M91	2	1003757	4014486461459
4	AIR CONDITIONING COMPRESSOR DRIVE	529964M1	1	1002534	4014486494556
5	MAIN DRIVE	833865M1	1	1003665	4014486490879
6	ROTARY SCREEN - COUNTERSHAFT	833867M1	1	1000119	4014486461305
7	RETURN ELEVATOR DRIVE	833854M2	1	1000335	4014486465754
10	STRAW CHOPPER (FRONT)	843948M1	1	1001451	4014486459593
11	STRAW CHOPPER (CENTER)	843747M1	1	1000827	4014486472547
12	STRAW CHOPPER (REAR) 102.5 INCH	843760M1	1	1000803	4014486472233
15	SHAKER SHOE DRIVE	273757M91	2	1000381	4014486466447
17	CLEANING FAN DRIVE	833863M1	1	1001400	4014486459067
18	TRACTION (UPPER) - 4 SPEED	833858M4	1	No AP	
19	TRACTION (LOWER) - 4 SPEED (SERIAL NR. ... - 19115)	833858M4	1	No AP	
20	COUNTERSHAFT - ROTARY SCREEN	844306M1	1	1000116	4014486461251
21	TANK UNLOADER DRIVE	833862M3	1	1003597	4014486485059
22	WOBBLE BOX - FLOATING CUT BAR 22 FEET	227455M1	1	1000698	4014486470802
22	WOBBLE BOX - FLOATING CUT BAR 22 FEET	832832M1	1	1000688	4014486470680
22	WOBBLE BOX - FLOATING CUT BAR 15 FEET - 20 FEET	833962M1	1	1000673	4014486470444
23	WOBBLE BOX DRIVE	834190M1	1	1000597	4014486469295
23	DRAPER TABLE	842809M1	1	1000700	4014486470833
24	REEL DRIVE	834140M1	1	1000734	4014486471281
25	REEL DRIVE COUNTERSHAFT	834139M1	1	1000567	4014486468748

### 3640

11	USED WITH THE A6.354.4 ENGINE	2834466M1	1	1003399	4014486462937
19	USED WITH THE A6.354.4 ENGINE	3145238M1	1	1002584	4014486495706
19	USED WITH THE A6.358 ENGINE	487802M2	1	1002550	4014486494822

### 5650

		1483884M1	1	1000677	4014486470505

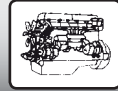
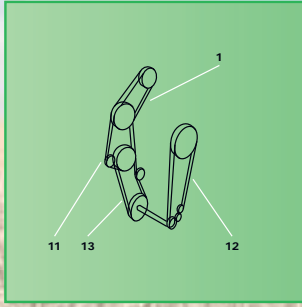
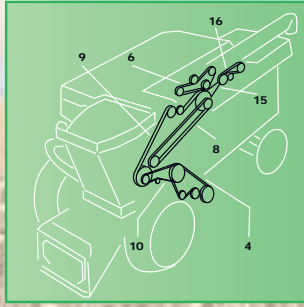
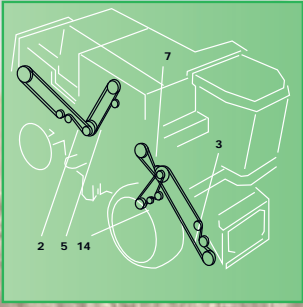

# MASSEY FERGUSON

8560

4	ELEVATOR DRIVE GRAIN	227455M1	1	1000698	4014486470802
5	JACKSHAFT - SPREADER	227455M1	1	1000698	4014486470802
8	UNLOADING DRIVE	101102M1	1	1001662	4014486486186
10	SHAKER SHOE PITMAN DRIVE	2593000W1	1	1001604	4014486485295

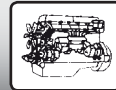
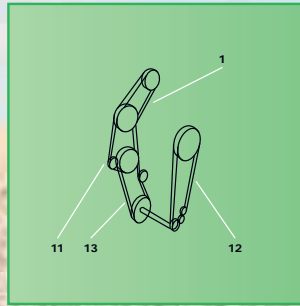
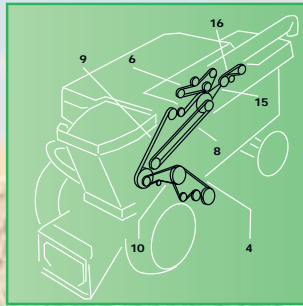
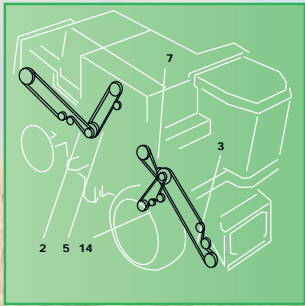

## MASSEY FERGUSON

### 8570

2	SPREADER DRIVE	1680230W1	1	1004118	4014486522921
3	FEEDER DRIVE HIGH CAPACITY (4 RIB)	104072W1	1	1001171	4014486491821
4	ELEVATOR DRIVE GRAIN	227455M1	1	1000698	4014486470802
5	CHOPPER DRIVE - JACKSHAFT	103319M1	1	1000692	4014486470710
5	SPREADER JACKSHAFT DRIVE	227455M1	1	1000698	4014486470802
8	UNLOADING DRIVE	101102M1	1	1001662	4014486486186
10	SHAKER SHOE PITMAN DRIVE	2593000W1	1	1001604	4014486485295

### 8780

1	FEEDER DRIVE	71379105	1	1001170	4014486491814
4	ELEVATOR DRIVE UNIT	71385801	1	1003628	4014486519013
6	CHOPPER DRIVE - 2ND STAGE	71388712	1	1000821	4014486472479
7	AUGER DRIVE	1680230W1	1	1004118	4014486522921
8	REEL DRIVE	227455M1	1	1000698	4014486470802
9	JACKSHAFT DRIVE	103319M1	1	1000692	4014486470710
11	UNLOADING DRIVE	101102M1	1	1001662	4014486486186
13		227455M1	1	1000698	4014486470802
14	PITMAN DRIVE	2593000W1	1	1001604	4014486485295
16	BEATER DRIVE	71386352	1	1001900	4014486489606
18	MAIN COUNTERSHAFT DRIVE	71385693	1	1003357	4014486488951
19	MAIN COUNTERSHAFT DRIVE	71387775	1	1003643	4014486489156
21	HYDRAULIC PUMP ROTOR DRIVE	111954W1	1	1001166	4014486491777
23	FAN DRIVE	71148120	1	1002556	4014486494983

### 9720

11	HYDROSTATIC PUMP DRIVE	31-2449520	1	1001948	4014486490527
----	------------------------	------------	---	---------	---------------

### 186 (F)

1	TABLE FEEDER DRUM	1724154M1	1	1000647	4014486470079
1	TABLE FEEDER DRUM	417974M1	1	1000651	4014486470116
2	TANK UNLOADER DRIVE	621259M1	1	1000547	4014486468311
3	FANNING MILL (UPPER)	621261M1	1	1000284	4014486464641
5	BEATER DRIVE	418232M1	1	No AP	
7	STRAW WALKER SHAKER	621258M1	1	1000346	4014486465983
8	TRACTION (UPPER)	905921M1	1	1004743	4014486720303
9	TRACTION (LOWER)	905920M1	1	1001450	4014486459586
10	REDUCER	417972M1	1	1000885	4014486473261
12	KNIFE DRIVE	1722835M1	1	1003502	4014486469097
12	KNIFE DRIVE	402607M1	1	1003515	4014486469653
15	FANNING MILL	621262M1	1	1003334	4014486462586

### 186 OLD

6	KNIFE DRIVE (UPPER)	417972M1	1	1000885	4014486473261
7	FEEDER DRIVE	1724154M1	1	1000647	4014486470079
7	FEEDER DRIVE	417974M1	1	1000651	4014486470116
8	KNIFE DRIVE	402607M1	1	1003515	4014486469653
10	TANK UNLOADER DRIVE	621259M1	1	1000547	4014486468311
11	BEATER BEHIND CYLINDER	418232M1	1	No AP	
12	HYDRAULIC PUMP DRIVE	417468M1	1	1003397	4014486462821
	RADIATOR FAN DRIVE	893575M1	1	1000060	4014486483802

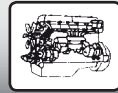

## MASSEY FERGUSON

### 206 OLD

1	SHAKER SHOE DRIVE	621258M1	1	1000346	4014486465983
2	BEATER - FAN (REAR)	621261M1	1	1000284	4014486464641
3	FANNING MILL	621262M1	1	1003334	4014486462586
4	DRUM DRIVE VARIABLE SPEED	905920M1	1	1001450	4014486459586
5	DRUM DRIVE VARIABLE SPEED	905921M1	1	1004743	4014486720303
6	KNIFE DRIVE (UPPER)	417972M1	1	1000885	4014486473261
7	FEEDER DRIVE	1724154M1	1	1000647	4014486470079
8	KNIFE DRIVE	402607M1	1	1003515	4014486469653
9	KNIFE DRIVE	1722835M1	1	1003502	4014486469097
11	BEATER (REAR)	418232M1	1	No AP	

### 307 OLD

2	KNIFE DRIVE (UPPER)	417972M1	1	1000885	4014486473261
3	TRACTION VARIATOR DRIVE	905920M1	1	1001450	4014486459586
5	SHAKER SHOE DRIVE	621258M1	1	1000346	4014486465983
6	TRACTION VARIATOR DRIVE	905921M1	1	1004743	4014486720303
7	KNIFE DRIVE	1722835M1	1	1003502	4014486469097
7	KNIFE DRIVE	402607M1	1	1003515	4014486469653
9	BEATER - FAN (REAR)	621261M1	1	1000284	4014486464641
11	FEEDER DRIVE	1724154M1	1	1000647	4014486470079
12	FAN CLEANING	621262M1	1	1003334	4014486462586
14	BEATER (REAR)	418232M1	1	No AP	

### 3640 Advanced

		1483884M1	1	1000677	4014486470505
--	--	-----------	---	---------	---------------

### 400 - 500

1	RADIATOR FAN DRIVE	228722M1	1	1000214	4014486462708
2	RADIATOR FAN DRIVE	233950M1	1	1003334	4014486462586
3	HYDRAULIC PUMP DRIVE	832490M1	1	1001277	4014486474435
4	VENTILATOR	227976M1	1	1000214	4014486462708
6	BEATER DRIVE	832538M1	1	1003431	4014486464313
9	COUNTERSHAFT DRIVE	227457M1	1	1000572	4014486468809
10	HOPPER	227984M1	1	1000731	4014486471250

### 400 - 500 OLD

2	COUNTERSHAFT - REEL DRIVE	1855008M1	1	1000572	4014486468809
5	BEATER (REAR)	793863M1	1	No AP	
6	REEL DRIVE	785810M1	1	1000378	4014486466416
8	RETURN ELEVATOR DRIVE	832538M1	1	1003431	4014486464313
9	RADIATOR AIR INTAKE	228722M1	1	1000214	4014486462708
10	STRAW WALKER DRIVE	1615254M1	1	1000765	4014486471687
10	STRAW WALKER DRIVE	320593M2	1	1001361	4014486474756
15	HYDRAULIC PUMP DRIVE	832490M1	1	1001277	4014486474435
16	RADIATOR FAN DRIVE	233950M1	1	1003334	4014486462586

### 410 - 415

1	FANNING MILL	784797M2	1	1000214	4014486462708
3	FANNING MILL (UPPER)	1855008M1	1	1000572	4014486468809
5	HYDRAULIC PUMP DRIVE	832490M1	1	1001277	4014486474435
6	ALTERNATOR DRIVE	893575M1	1	1000060	4014486483802
7	DRIVE	793863M1	1	No AP	
10	RETURN DRIVE	795514M4	1	1000264	4014486464214

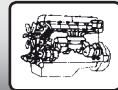

## MASSEY FERGUSON

10	RETURN DRIVE	795582M2	1	1000249	4014486463828
11	SHAKER SHAFT DRIVE	1615254M1	1	1000765	4014486471687
12	ELEVATOR DRIVE GRAIN	784796M2	1	1003546	4014486471243
16	KNIFE DRIVE	785585M3	1	1004096	4014486518696
17	REEL DRIVE	1615254M1	1	1000765	4014486471687
17	REEL DRIVE	1615333M1	1	1000743	4014486471397

### 410 - 415 -510 - 515 OLD

2	COUNTERSHAFT - REEL DRIVE	1855008M1	1	1000572	4014486468809
5	BEATER (REAR)	793863M1	1	No AP	
6	REEL DRIVE	1615333M1	1	1000743	4014486471397
8	RETURN ELEVATOR DRIVE	795514M4	1	1000264	4014486464214
9	RADIATOR AIR INTAKE	228722M1	1	1000214	4014486462708
10	STRAW WALKER DRIVE	1615254M1	1	1000765	4014486471687
15	HYDRAULIC PUMP DRIVE	832490M1	1	1001277	4014486474435
16	RADIATOR FAN DRIVE	233950M1	1	1003334	4014486462586
17	KNIFE DRIVE	785585M3	1	1004096	4014486518696

### 410 - 510

1	ENGINE FAN DRIVE	240575M2	1	1002298	4014486479867
2	HYDRAULIC PUMP DRIVE	832490M1	1	1001277	4014486474435
3	AIR FILTER	228722M1	1	1000214	4014486462708
4	VENTILATOR	227976M1	1	1000214	4014486462708
6	HYDRAULIC PUMP DRIVE	230381M1	1	1003482	4014486468182
8	VENTILATOR	227457M1	1	1000572	4014486468809
9	HOPPER	227984M1	1	1000731	4014486471250
10	REEL DRIVE	1615333M1	1	1000743	4014486471397

### 487 - 506 - 507

1	TABLE FEEDER DRUM	621588M1	1	1000668	4014486470352
2	TANK UNLOADER DRIVE	905980M1	1	1001552	4014486484519
3	FANNING MILL (UPPER)	621261M1	1	1000284	4014486464641
5	BEATER DRIVE	1720255M1	1	1001871	4014486489125
7	STRAW WALKER SHAKER	621258M1	1	1000346	4014486465983
10	REDUCER	417972M1	1	1000885	4014486473261
12	KNIFE DRIVE	402607M1	1	1003515	4014486469653
12	KNIFE DRIVE	410959M1	1	1003512	4014486469516
15	FANNING MILL	621262M1	1	1003334	4014486462586

### 487 OLD

1	SHAKER SHOE DRIVE	621258M1	1	1000346	4014486465983
2	BEATER - FAN (REAR)	621261M1	1	1000284	4014486464641
6	KNIFE DRIVE (UPPER)	417972M1	1	1000885	4014486473261
7	FEEDER DRIVE	1720488M1	1	1000675	4014486470475
8	KNIFE DRIVE	402607M1	1	1003515	4014486469653
9	FEEDER AUGER	1722835M1	1	1003502	4014486469097
10	TANK UNLOADER DRIVE	621259M1	1	1000547	4014486468311
11	BEATER (REAR)	1720255M1	1	1001871	4014486489125
13	HYDRAULIC PUMP DRIVE	1720674M2	1	1000220	4014486462838

### 506 OLD

1	SHAKER SHOE DRIVE	621258M1	1	1000346	4014486465983
2	BEATER - FAN (REAR)	621261M1	1	1000284	4014486464641
3	FANNING MILL	621262M1	1	1003334	4014486462586
6	KNIFE DRIVE (UPPER)	417972M1	1	1000885	4014486473261





## MASSEY FERGUSON

7	FEEDER DRIVE	621588M1	1	1000668	4014486470352
8	KNIFE DRIVE	402607M1	1	1003515	4014486469653
9	FEEDER AUGER	410959M1	1	1003512	4014486469516
10	TANK UNLOADER DRIVE	905980M1	1	1001552	4014486484519
11	BEATER (REAR)	1720255M1	1	1001871	4014486489125
<b>507 OLD</b>					
1	SHAKER SHOE DRIVE	621258M1	1	1000346	4014486465983
4	BEATER (REAR)	1720205M3	1	1001889	4014486489460
6	BEATER (REAR)	621261M1	1	1000284	4014486464641
7	FANNING MILL	621262M1	1	1003334	4014486462586
8	FEEDER DRIVE	621588M1	1	1000668	4014486470352
9	TANK UNLOADER DRIVE	905980M1	1	1001552	4014486484519
10	HYDRAULIC PUMP DRIVE	1720674M2	1	1000220	4014486462838
13	KNIFE DRIVE	410959M1	1	1003512	4014486469516
<b>520 - 525</b>					
2	DRUM DRIVE	912877M1	1	1001181	4014486490190
3	DRIVE RIGHT SIDE	227976M1	1	1000214	4014486462708
7	THRESHING DRIVE	619327M1	1	1004086	4014486520392
8	HYDRAULIC PUMP DRIVE	619595M1	1	1000536	4014486468168
12	AUGER DRIVE	227984M1	1	1000731	4014486471250
15	REEL DRIVE VARIABLE SPEED	789853M1	1	1001403	4014486459098
<b>520 OLD</b>					
1	TANK UNLOADER DRIVE	619317M2	1	1000563	4014486468656
3	HYDRAULIC PUMP DRIVE	782850M2	1	1000537	4014486468175
5	CASCADE SEPARATOR	784170M2	1	1000425	4014486466881
6	COUNTERSHAFT 2ND STAGE - GRAIN AUGER	784796M2	1	1003546	4014486471243
7	COUNTERSHAFT - FAN - 2ND STAGE	784797M2	1	1000214	4014486462708
8	KNIFE DRIVE	785585M3	1	1004096	4014486518696
9	COUNTERSHAFT DRIVE - 2ND STAGE	785585M3	1	1004096	4014486518696
10	REEL DRIVE VARIABLE SPEED	789853M1	1	1001403	4014486459098
11	PICK UP REEL	1615333M1	1	1000743	4014486471397
11	REEL DRIVE	785810M1	1	1000378	4014486466416
12	BEATER (REAR)	789967M1	1	1000986	4014486498066
13	RETURN ELEVATOR DRIVE	795514M4	1	1000264	4014486464214
13	RETURN ELEVATOR DRIVE	795582M2	1	1000249	4014486463828
14	STRAW WALKER DRIVE	1615254M1	1	1000765	4014486471687
17	MAIN DRIVE	789930M1	1	1002617	4014486498080
17	MAIN DRIVE	789931M1	1	1002616	4014486498073
<b>525 OLD</b>					
1	TANK UNLOADER DRIVE	619317M2	1	1000563	4014486468656
3	HYDRAULIC PUMP DRIVE	782850M2	1	1000537	4014486468175
5	CASCADE SEPARATOR	784170M2	1	1000425	4014486466881
6	COUNTERSHAFT 2ND STAGE - GRAIN AUGER	784796M2	1	1003546	4014486471243
7	COUNTERSHAFT - FAN - 2ND STAGE	784797M2	1	1000214	4014486462708
8	KNIFE DRIVE	785585M3	1	1004096	4014486518696
9	COUNTERSHAFT DRIVE - 2ND STAGE	785585M3	1	1004096	4014486518696
10	REEL DRIVE VARIABLE SPEED	789853M1	1	1001403	4014486459098
11	PICK UP REEL	1615333M1	1	1000743	4014486471397
11	REEL DRIVE	785810M1	1	1000378	4014486466416
12	BEATER (REAR)	789967M1	1	1000986	4014486498066
13	RETURN ELEVATOR DRIVE	795514M4	1	1000264	4014486464214



## MASSEY FERGUSON

13	RETURN ELEVATOR DRIVE	795582M2	1	1000249	4014486463828
14	STRAW WALKER DRIVE	1615254M1	1	1000765	4014486471687
17	MAIN DRIVE	789930M1	1	1002617	4014486498080
17	MAIN DRIVE	789931M1	1	1002616	4014486498073
<b>530 S</b>					
1	FANNING MILL	3043153M1	1	1001399	4014486459050
1	FANNING MILL	3043154M1	1	1001398	4014486459043
2	TANK UNLOADER DRIVE	3370141M1	1	1001746	4014486487305
3	FANNING MILL (UPPER)	785585M3	1	1004096	4014486518696
5	HYDRAULIC PUMP DRIVE	843313M1	1	1001016	4014486497991
6	ALTERNATOR DRIVE	1687531M1	1	1002558	4014486495034
7	DRIVE	789967M1	1	1000986	4014486498066
8	MAIN BELT	789930M1	1	1002617	4014486498080
8	MAIN BELT	789931M1	1	1002616	4014486498073
10	RETURN DRIVE	795514M4	1	1000264	4014486464214
10	RETURN DRIVE	795582M2	1	1000249	4014486463828
11	SHAKER SHAFT DRIVE	1615254M1	1	1000765	4014486471687
12	ELEVATOR DRIVE GRAIN	784796M2	1	1003546	4014486471243
15	REDUCER	789853M1	1	1001403	4014486459098
16	KNIFE DRIVE	1724154M1	1	1000647	4014486470079
17	REEL DRIVE	843313M1	1	1001016	4014486497991
<b>5650 Advanced</b>					
		1483884M1	1	1000677	4014486470505
<b>5650 Turbo</b>					
		1483884M1	1	1000677	4014486470505
<b>620 - 625</b>					
4	REEL DRIVE	785810M1	1	1000378	4014486466416
9	REEL DRIVE	1615333M1	1	1000743	4014486471397
11	REEL DRIVE VARIABLE SPEED	789853M1	1	1001403	4014486459098
12	THRESHING DRIVE	789931M1	1	1002616	4014486498073
13	DRUM DRIVE	789967M1	1	1000986	4014486498066
<b>620 OLD</b>					
1	TANK UNLOADER DRIVE	619317M2	1	1000563	4014486468656
3	HYDRAULIC PUMP DRIVE	782850M2	1	1000537	4014486468175
5	CASCADE SEPARATOR	784170M2	1	1000425	4014486466881
6	COUNTERSHAFT 2ND STAGE - GRAIN AUGER	784796M2	1	1003546	4014486471243
7	COUNTERSHAFT - FAN - 2ND STAGE	784797M2	1	1000214	4014486462708
8	KNIFE DRIVE	785585M3	1	1004096	4014486518696
9	COUNTERSHAFT DRIVE - 2ND STAGE	785585M3	1	1004096	4014486518696
10	REEL DRIVE VARIABLE SPEED	789853M1	1	1001403	4014486459098
11	PICK UP REEL	1615333M1	1	1000743	4014486471397
11	REEL DRIVE	785810M1	1	1000378	4014486466416
12	BEATER (REAR)	789967M1	1	1000986	4014486498066
13	RETURN ELEVATOR DRIVE	795514M4	1	1000264	4014486464214
13	RETURN ELEVATOR DRIVE	795582M2	1	1000249	4014486463828
14	STRAW WALKER DRIVE	1615254M1	1	1000765	4014486471687
17	MAIN DRIVE	789930M1	1	1002617	4014486498080
17	MAIN DRIVE	789931M1	1	1002616	4014486498073



# MASSEY FERGUSON

## 625 OLD

1	TANK UNLOADER DRIVE	619317M2	1	1000563	4014486468656
3	HYDRAULIC PUMP DRIVE	782850M2	1	1000537	4014486468175
5	CASCADE SEPARATOR	784170M2	1	1000425	4014486466881
6	COUNTERSHAFT 2ND STAGE - GRAIN AUGER	784796M2	1	1003546	4014486471243
7	COUNTERSHAFT - FAN - 2ND STAGE	784797M2	1	1000214	4014486462708
8	KNIFE DRIVE	785585M3	1	1004096	4014486518696
9	COUNTERSHAFT DRIVE - 2ND STAGE	785585M3	1	1004096	4014486518696
10	REEL DRIVE VARIABLE SPEED	789853M1	1	1001403	4014486459098
11	PICK UP REEL	1615333M1	1	1000743	4014486471397
11	REEL DRIVE	785810M1	1	1000378	4014486466416
12	BEATER (REAR)	789967M1	1	1000986	4014486498066
13	RETURN ELEVATOR DRIVE	795514M4	1	1000264	4014486464214
13	RETURN ELEVATOR DRIVE	795582M2	1	1000249	4014486463828
14	STRAW WALKER DRIVE	1615254M1	1	1000765	4014486471687
17	MAIN DRIVE	789930M1	1	1002617	4014486498080
17	MAIN DRIVE	789931M1	1	1002616	4014486498073

## 630 OLD

1	TANK UNLOADER DRIVE	324872M1	1	1000215	4014486462739
4	TABLE DRIVE	320595M2	1	1000540	4014486468229
4	TABLE DRIVE	322768M1	1	1003482	4014486468182
5	CYLINDER	320496M3	1	No AP	
6	KNIFE DRIVE	320623M2	1	1003438	4014486464894
7	FEEDER AUGER	320596M1	1	1003412	4014486463545
8	TRACTION VARIATOR DRIVE	320551M1	1	1001063	4014486496475
9	HYDRAULIC PUMP DRIVE	410195M1	1	1002281	4014486478495
10	STRAW WALKER DRIVE	320593M2	1	1001361	4014486474756

## 630 S OLD

1	TANK UNLOADER DRIVE	324872M1	1	1000215	4014486462739
4	TABLE DRIVE	320595M2	1	1000540	4014486468229
4	TABLE DRIVE	322768M1	1	1003482	4014486468182
5	CYLINDER	320496M3	1	No AP	
6	KNIFE DRIVE	320623M2	1	1003438	4014486464894
7	FEEDER AUGER	320596M1	1	1003412	4014486463545
8	TRACTION VARIATOR DRIVE	320551M1	1	1001063	4014486496475
9	HYDRAULIC PUMP DRIVE	410195M1	1	1002281	4014486478495
10	STRAW WALKER DRIVE	320593M2	1	1001361	4014486474756

## 685 OLD

1	KNIFE DRIVE	402607M1	1	1003515	4014486469653
2	TRACTION VARIATOR DRIVE	401110M1	1	1001160	4014486497397
3	CYLINDER	402608M3	1	No AP	
7	HYDRAULIC PUMP DRIVE (PERKINS)	403041M1	1	1000206	4014486462463
9	TANK UNLOADER DRIVE	403071M1	1	1003432	4014486464337
10	STRAW BALER	328656M1	1	1000527	4014486468076
11	FANNING MILL	402604M1	1	1003390	4014486462579
12	FANNING MILL	402605M1	1	1003428	4014486464238
13	BEATER (REAR)	402606M1	1	1003523	4014486469936

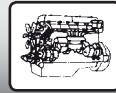
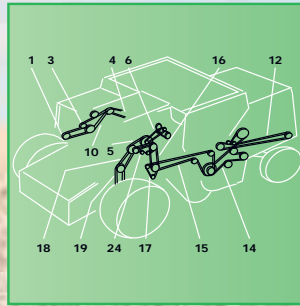
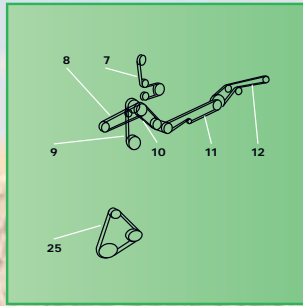
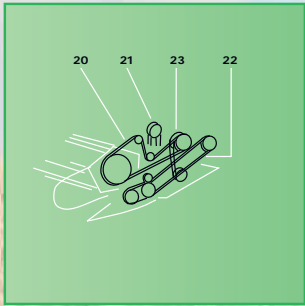

## MASSEY FERGUSON

### 685 S OLD

1	KNIFE DRIVE	402607M1	1	1003515	4014486469653
2	TRACTION VARIATOR DRIVE	401110M1	1	1001160	4014486497397
3	CYLINDER	402608M3	1	No AP	
7	HYDRAULIC PUMP DRIVE (PERKINS)	403041M1	1	1000206	4014486462463
9	TANK UNLOADER DRIVE	403071M1	1	1003432	4014486464337
10	STRAW BALER	328656M1	1	1000527	4014486468076
11	FANNING MILL	402604M1	1	1003390	4014486462579
12	FANNING MILL	402605M1	1	1003428	4014486464238
13	BEATER (REAR)	402606M1	1	1003523	4014486469936

### 750 OLD

1		834140M1	1	1000734	4014486471281
2	REEL DRIVE VARIABLE SPEED	833768M1	1	1001402	4014486459081
3	REEL DRIVE	834139M1	1	1000567	4014486468748
4	WOBBLE BOX DRIVE	834058M1	1	1000598	4014486469301
4	WOBBLE BOX DRIVE	842809M1	1	1000700	4014486470833
5	TRACTION DRIVE	833856M1	1	No AP	
7	TRACTION DRIVE	833874M1	1	1001848	4014486488791
9	DISCHARGE DRIVE GRAIN TANK	833873M1	1	1001568	4014486484717
12	STRAW WALKER DRIVE	833855M1	1	1000419	4014486466829
12	STRAW WALKER DRIVE	843310M1	1	1000429	4014486466935
16	HYDRAULIC PUMP DRIVE	222882M2	1	1000232	4014486463262
17	RADIATOR FAN DRIVE	273837M91	1	1002490	4014486493931
18	ALTERNATOR DRIVE (DIESEL ENGINE)	259047M91	2	1000131	4014486461473
19	AIR CONDITIONING COMPRESSOR DRIVE	834492M2	1	1000211	4014486462593
19	AIR CONDITIONING COMPRESSOR DRIVE	843045M1	1	1002543	4014486494723
22	STRAW CHOPPER DRIVE	833871M1	1	1001747	4014486485417
24	STRAW CHOPPER DRIVE	833872M1	1	1000762	4014486471632
24	STRAW CHOPPER DRIVE	843324M1	1	1000804	4014486472240
25	RETURN ELEVATOR DRIVE	833854M2	1	1000335	4014486465754

### 760 - 765

1	HYDRAULIC PUMP DRIVE (SERIAL NR. 00511-2474)	222882M2	1	1000232	4014486463262
2	RADIATOR FAN DRIVE	259047M91	2	1000131	4014486461473
3	ALTERNATOR DRIVE	1687531M1	1	1002558	4014486495034
4	AIR CONDITIONING COMPRESSOR DRIVE	1686883M1	1	1002534	4014486494556
4	AIR CONDITIONING COMPRESSOR DRIVE (SERIAL NR. 5829-7663)	843045M1	1	1002543	4014486494723
5	MAIN DRIVE	833865M1	1	1003665	4014486490879
6	AIR INTAKE DRIVE	833867M1	1	1000119	4014486461305
10	STRAW CHOPPER DRIVE (SERIAL NR. ... - 9413)	833871M1	1	1001747	4014486485417
10	STRAW CHOPPER DRIVE (SERIAL NR. 9413 - ...)	843948M1	1	1001451	4014486459593
11	STRAW CHOPPER DRIVE (SERIAL NR. 9413 - ...)	843747M1	1	1000827	4014486472547
12	STRAW CHOPPER DRIVE (SERIAL NR. 9413 - ...)	832906M1	1	1000758	4014486471595
12	STRAW CHOPPER DRIVE (SERIAL NR. ... - 9413)	833872M1	1	1000762	4014486471632
12	STRAW CHOPPER DRIVE	843760M1	1	1000803	4014486472233
14	STRAW WALKER DRIVE	833860M1	1	1000820	4014486472462
15	SHAKER SHOE DRIVE	273757M91	2	1000381	4014486466447
16	SHAKER SHOE - COUNTERSHAFT - FAN (SERIAL NR. ... - 9413)	274015M91	1	1003436	4014486464795
16	SHAKER SHOE - COUNTERSHAFT - FAN (SERIAL NR. 9413 - ...)	281560M91	2	1002782	4014486464832
17	CLEANING FAN DRIVE	833863M1	1	1001400	4014486459067
18	TRACTION (UPPER) - 4 SPEED	833858M4	1	No AP	
19	TRACTION (LOWER) - 4 SPEED	833858M4	1	No AP	
20	REEL DRIVE	834140M1	1	1000734	4014486471281

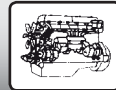

## MASSEY FERGUSON

21	REEL DRIVE VARIABLE SPEED	833768M1	1	1001402	4014486459081
22	KNIFE WOBBLE - FLOATING CUT BAR	833962M1	1	1000673	4014486470444
22	KNIFE DRIVE - RIDIG CUT BAR 13 FEET	834058M1	1	1000598	4014486469301
22	KNIFE WOBBLE RIDIG CUT BAR - 15 FEET - 24 FEET	834190M1	1	1000597	4014486469295
22	WOBBLE BOX - WITH DRAPER TABLE	842809M1	1	1000700	4014486470833
23	REEL DRIVE COUNTERSHAFT	834139M1	1	1000567	4014486468748
24	DISCHARGE DRIVE GRAIN TANK	833862M3	1	1003597	4014486485059
<b>760 OLD</b>					
1	REEL DRIVE	834140M1	1	1000734	4014486471281
2	REEL DRIVE VARIABLE SPEED	833768M1	1	1001402	4014486459081
3	REEL DRIVE	834139M1	1	1000567	4014486468748
4	WOBBLE BOX DRIVE	834058M1	1	1000598	4014486469301
4	WOBBLE BOX DRIVE	834190M1	1	1000597	4014486469295
4	WOBBLE BOX DRIVE	842809M1	1	1000700	4014486470833
5	TRACTION DRIVE	833858M4	1	No AP	
6	MAIN DRIVE	833865M1	1	1003665	4014486490879
7	AIR INTAKE DRIVE	833867M1	1	1000119	4014486461305
8	DISCHARGE DRIVE GRAIN TANK	833862M3	1	1003597	4014486485059
11	STRAW WALKER DRIVE	833860M1	1	1000820	4014486472462
14	HYDRAULIC PUMP DRIVE	222882M2	1	1000232	4014486463262
18	AIR CONDITIONING COMPRESSOR DRIVE	834492M2	1	1000211	4014486462593
18	AIR CONDITIONING COMPRESSOR DRIVE	843045M1	1	1002543	4014486494723
21	STRAW CHOPPER DRIVE	833871M1	1	1001747	4014486485417
23	STRAW CHOPPER DRIVE	833872M1	1	1000762	4014486471632
23	STRAW CHOPPER DRIVE	843324M1	1	1000804	4014486472240
24	RETURN ELEVATOR DRIVE	833854M2	1	1000335	4014486465754
<b>86 (F)</b>					
1	TABLE FEEDER DRUM	412236M1	1	1003530	4014486470369
2	TANK UNLOADER DRIVE	412074M1	1	1003402	4014486463170
3	FANNING MILL (UPPER)	402605M1	1	1003428	4014486464238
4	HYDRAULIC PUMP DRIVE	402604M1	1	1003390	4014486462579
5	BEATER DRIVE	402608M3	1	No AP	
8	TRACTION (UPPER)	412333M1	1	1003574	4014486497403
8	TRACTION (UPPER)	905921M1	1	1004743	4014486720303
9	TRACTION (LOWER)	401110M1	1	1001160	4014486497397
10	REDUCER	412237M1	1	1000886	4014486473278
11	AUGER DRIVE (FRONT)	412399M1	1	1000557	4014486468519
12	KNIFE DRIVE	402607M1	1	1003515	4014486469653
15	FANNING MILL	402604M1	1	1003390	4014486462579
<b>86 OLD</b>					
1	TRACTION DRIVE	412333M1	1	1003574	4014486497403
2	TRACTION DRIVE	401110M1	1	1001160	4014486497397
3	HYDRAULIC PUMP DRIVE	403041M1	1	1000206	4014486462463
5	KNIFE DRIVE	402607M1	1	1003515	4014486469653
6	BEATER BEHIND CYLINDER	402608M3	1	No AP	
7	KNIFE DRIVE (UPPER)	412237M1	1	1000886	4014486473278
8	FEEDER AUGER	412399M1	1	1000557	4014486468519
9	STRAW BALER	328656M1	1	1000527	4014486468076
10	FANNING MILL	402604M1	1	1003390	4014486462579
11	FANNING MILL (UPPER)	402605M1	1	1003428	4014486464238
12	TANK UNLOADER DRIVE	412074M1	1	1003402	4014486463170
13	FEEDER DRIVE	412236M1	1	1003530	4014486470369

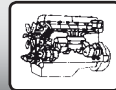

## MASSEY FERGUSON

### 87 (F)

1	TABLE FEEDER DRUM	412236M1	1	1003530	4014486470369
2	TANK UNLOADER DRIVE	412074M1	1	1003402	4014486463170
3	FANNING MILL (UPPER)	402605M1	1	1003428	4014486464238
4	HYDRAULIC PUMP DRIVE	417468M1	1	1003397	4014486462821
5	BEATER DRIVE	402608M3	1	No AP	
8	TRACTION (UPPER)	905921M1	1	1004743	4014486720303
9	TRACTION (LOWER)	401110M1	1	1001160	4014486497397
10	REDUCER	412237M1	1	1000886	4014486473278
11	AUGER DRIVE (FRONT)	412399M1	1	1000557	4014486468519
12	KNIFE DRIVE	402607M1	1	1003515	4014486469653
15	FANNING MILL	621262M1	1	1003334	4014486462586

### 87 OLD

1	TRACTION DRIVE	412333M1	1	1003574	4014486497403
2	TRACTION DRIVE	401110M1	1	1001160	4014486497397
3	HYDRAULIC PUMP DRIVE	403041M1	1	1000206	4014486462463
5	KNIFE DRIVE	402607M1	1	1003515	4014486469653
6	BEATER BEHIND CYLINDER	402608M3	1	No AP	
7	KNIFE DRIVE (UPPER)	412237M1	1	1000886	4014486473278
8	FEEDER AUGER	412399M1	1	1000557	4014486468519
9	STRAW BALER	328656M1	1	1000527	4014486468076
10	FANNING MILL	402604M1	1	1003390	4014486462579
11	FANNING MILL (UPPER)	402605M1	1	1003428	4014486464238
12	TANK UNLOADER DRIVE	412074M1	1	1003402	4014486463170
13	FEEDER DRIVE	412236M1	1	1003530	4014486470369

### CHALLENGER 660

1	UNLOADING DRIVE	101102M1	1	1001662	4014486486186
2	ELEVATOR DRIVE (SERIAL NR. ... - HP87101) GRAIN	227455M1	1	1000698	4014486470802
3	ELEVATOR DRIVE (SERIAL NR. HP87101 - ...) GRAIN	71403685	1	1004121	4014486522952
4	SHAKER SHOE PITMAN DRIVE	71390199	1	1003933	4014486485301
5	BEATER DRIVE	71386352	1	1001900	4014486489606
6	MAIN COUNTERSHAFT DRIVE	71390188	1	1001877	4014486489255
7	TANDEM PUMP DRIVE (SERIAL NR. ... - HR87101)	71418976	1	1003716	4014486519839
8	TANDEM PUMP DRIVE (SERIAL NR. HR87101 - ...)	71418984	1	1004614	4014486717440
9	HEADER COUNTERSHAFT TO PIVOT SHAFT (SERIAL NR. HP87101 - ...)	71398388	1	1001391	4014486475098
10	BEATER TO HEADER COUNTERSHAFT DRIVE (SERIAL NR. ... - HP87101)	71379105	1	1001170	4014486491814
12	RETURN ELEVATOR DRIVE	71385801	1	1003628	4014486519013
13	CHOPPER DRIVE - 2ND STAGE (SERIAL NR. ... - HR87101)	71388712	1	1000821	4014486472479
14	CHOPPER DRIVE - 2ND STAGE (SERIAL NR. HR87101 - ...)	71406339	1	1003617	4014486486780
15	SPREADER DRIVE	1680230W1	1	1004118	4014486522921
16	SPREADER JACKSHAFT DRIVE	227455M1	1	1000698	4014486470802
18	CHOPPER DRIVE - 1ST STAGE (SERIAL NR. HR87101 - ...)	71406361	1	1001645	4014486485974
19	AIR CONDITIONING COMPRESSOR DRIVE	71148120	1	1002556	4014486494983
24	BEATER TO FEEDER HOUSE JACKSHAFT DRIVE (SERIAL NR. HP87101 - ...)	71398384	1	1004135	4014486523171
25	VARIABLE SPEED TO HEADER COUNTERSHAFT (SERIAL NR. HP87101 - ...)	71399505	1	No AP	
26	JACKSHAFT - HEADER COUNTERSHAFT (SERIAL NR. HP87101 - ...)	71399519	1	1001148	4014486490121
27	ROTARY SCREEN DRIVE (SERIAL NR. HR87101 - ...)	71396754	1	1003660	4014486518399

### CHALLENGER 660 B

3	SHAKER SHOE PITMAN DRIVE	71390199	1	1003933	4014486485301
4	BEATER DRIVE	71388216	1	1004622	4014486717525
5	MAIN COUNTERSHAFT DRIVE	71390188	1	1001877	4014486489255

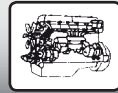

## MASSEY FERGUSON

6	TANDEM PUMP DRIVE	71418984	1	1004614	4014486717440
7	FEEDER PIVOT SHAFT DRIVE	71427255	1	1000801	4014486472202
9	RETURN ELEVATOR DRIVE	71385801	1	1003628	4014486519013
10	CHOPPER DRIVE - 2ND STAGE	71406339	1	1003617	4014486486780
11	SPREADER DRIVE (SECONDARY)	1680230W1	1	1004118	4014486522921
13	CHOPPER DRIVE - 1ST STAGE	71406338	1	1001648	4014486486001
14	AIR CONDITIONING COMPRESSOR DRIVE	71148120	1	1002556	4014486494983
16	BEATER TO FEEDER HOUSE JACKSHAFT	71398384	1	1004135	4014486523171
17	VARIABLE SPEED TO HEADER COUNTERSHAFT	71399505	1	No AP	
18	JACKSHAFT - HEADER COUNTERSHAFT	71399519	1	1001148	4014486490121
19	ROTARY SCREEN DRIVE	71396754	1	1003660	4014486518399

### CHALLENGER 670

1	UNLOADING DRIVE	101102M1	1	1001662	4014486486186
2	ELEVATOR DRIVE (SERIAL NR. ... - HP87101) GRAIN	227455M1	1	1000698	4014486470802
3	ELEVATOR DRIVE (SERIAL NR. HP87101 - ...) GRAIN	71403685	1	1004121	4014486522952
4	SHAKER SHOE PITMAN DRIVE	71390199	1	1003933	4014486485301
5	BEATER DRIVE	71388216	1	1004622	4014486717525
6	MAIN COUNTERSHAFT DRIVE	71390188	1	1001877	4014486489255
7	ROTOR PUMP DRIVE (SERIAL NR. ... - HR36101)	71418976	1	1003716	4014486519839
8	PROPULSION PUMP DRIVE (SERIAL NR. HR36101 - ...)	71418984	1	1004614	4014486717440
9	HEADER COUNTERSHAFT TO PIVOT SHAFT (SERIAL NR. HP36101 - ...)	71398388	1	1001391	4014486475098
10	BEATER TO HEADER COUNTERSHAFT DRIVE (SERIAL NR. ... - HP36101)	71379105	1	1001170	4014486491814
12	RETURN ELEVATOR DRIVE	71385801	1	1003628	4014486519013
13	CHOPPER DRIVE - 2ND STAGE (SERIAL NR. ... - HR36101)	71388712	1	1000821	4014486472479
14	CHOPPER DRIVE - 2ND STAGE (SERIAL NR. HR36101 - ...)	71406339	1	1003617	4014486486780
15	SPREADER DRIVE	1680230W1	1	1004118	4014486522921
16	SPREADER JACKSHAFT DRIVE	227455M1	1	1000698	4014486470802
18	CHOPPER DRIVE - 1ST STAGE (SERIAL NR. HR36101 - ...)	71406361	1	1001645	4014486485974
19	AIR CONDITIONING COMPRESSOR DRIVE	71148120	1	1002556	4014486494983
24	BEATER TO FEEDER HOUSE JACKSHAFT DRIVE (SERIAL NR. HP36101 - ...)	71398384	1	1004135	4014486523171
25	VARIABLE SPEED TO HEADER COUNTERSHAFT (SERIAL NR. HP36101 - ...)	71399505	1	No AP	
26	JACKSHAFT - HEADER COUNTERSHAFT (SERIAL NR. HP36101 - ...)	71399519	1	1001148	4014486490121
27	ROTARY SCREEN DRIVE	71396754	1	1003660	4014486518399

### CHALLENGER 670 B

3	SHAKER SHOE PITMAN DRIVE	71390199	1	1003933	4014486485301
4	BEATER DRIVE	71388216	1	1004622	4014486717525
5	MAIN COUNTERSHAFT DRIVE	71390188	1	1001877	4014486489255
6	ROTOR PUMP DRIVE	71418976	1	1003716	4014486519839
7	PROPULSION PUMP DRIVE	71418978	1	1003717	4014486519693
8	FEEDER PIVOT SHAFT DRIVE	71427255	1	1000801	4014486472202
10	RETURN ELEVATOR DRIVE	71385801	1	1003628	4014486519013
11	CHOPPER DRIVE - 2ND STAGE	71406339	1	1003617	4014486486780
12	SPREADER DRIVE (SECONDARY)	1680230W1	1	1004118	4014486522921
14	CHOPPER DRIVE - 1ST STAGE	71406338	1	1001648	4014486486001
15	AIR CONDITIONING COMPRESSOR DRIVE	71148120	1	1002556	4014486494983
17	BEATER TO FEEDER HOUSE JACKSHAFT	71398384	1	1004135	4014486523171
18	VARIABLE SPEED TO HEADER COUNTERSHAFT	71399505	1	No AP	
19	JACKSHAFT - HEADER COUNTERSHAFT	71399519	1	1001148	4014486490121
20	ROTARY SCREEN DRIVE	71396754	1	1003660	4014486518399



## MASSEY FERGUSON

### CHALLENGER 680 B

2	ELEVATOR DRIVE GRAIN	71403685	1	1004121	4014486522952
3	SHAKER SHOE PITMAN DRIVE	71390199	1	1003933	4014486485301
4	BEATER DRIVE	71388216	1	1004622	4014486717525
5	MAIN COUNTERSHAFT DRIVE	71403721	1	1002009	4014486491395
6	ROTOR PUMP DRIVE	71406285	1	1001961	4014486490695
7	PROPULSION PUMP DRIVE	71406286	1	1001831	4014486488548
8	FEEDER CONVEYOR DRIVE	71427255	1	1000801	4014486472202
10	CHOPPER DRIVE - 1ST STAGE	71406338	1	1001648	4014486486001
11	SPREADER DRIVE (SECONDARY)	1680230W1	1	1004118	4014486522921
12	CHOPPER DRIVE - 2ND STAGE	71406339	1	1003617	4014486486780
13	BEATER TO FEEDER HOUSE JACKSHAFT	71398384	1	1004135	4014486523171
14	JACKSHAFT - HEADER COUNTERSHAFT	71399519	1	1001148	4014486490121
18	RETURN ELEVATOR DRIVE	71385801	1	1003628	4014486519013
19	ROTARY SCREEN DRIVE	71396754	1	1003660	4014486518399

### MF 27

1	FEEDER DRUM - COUNTERSHAFT	41983500	1	1000611	4014486469493
3	COUNTERSHAFT (UPPER) - FEEDER SHAFT	41989200	1	1000908	4014486473568
3	COUNTERSHAFT (UPPER) - FEEDER SHAFT	41989400	1	1000911	4014486473605
4	FEEDER SHAFT (UPPER) - STRIPPER BEATER	41991700	1	1001844	4014486488739
7	INTERMEDIATE SHAFT - ECCENTRIC SHAFT	41982400	1	1003501	4014486469059
8	AUGER - LOWER RETURN AUGER (GRAIN)	41990100	1	1001377	4014486474916
9	INTERMEDIATE SHAFT - COUNTER SELECTOR	41987800	1	1000620	4014486469608
9	COUNTER SELECTOR - INTERMEDIATE SHAFT	41988000	1	1000698	4014486470802
10	STRIPPER BEATER - COUNTER SELECTOR	41934800	3	1002768	4014486465228
11	COUNTER SELECTOR - ENGINE	41993400	1	1003633	4014486488609
12	ENGINE - HYDRAULIC PUMP	41929000	1	1000251	4014486463897
12	ENGINE - HYDRAULIC PUMP	41930200	1	1000260	4014486464108
12	ENGINE - HYDRAULIC PUMP	D41929000	1	1000251	4014486463897
13	COUNTER SELECTOR - COUNTER DRIVE STRAW CHOPPER	41942100	1	1000404	4014486466676
14	COUNTER DRIVE STRAW CHOPPER	41987300	1	1000815	4014486472400
15	AWNER SHAFT	41912400	1	1003381	4014486461732
18	COUNTER SELECTOR - DISCHARGE AUGER	41936200	2	1002770	4014486465648
20	FILLING AUGER - STRIPPER BEATER	41982500	1	1000585	4014486469066
25	MAIN FAN SELECTOR - STRIPPER BEATER	41987900	1	1000575	4014486468847
28	MAIN FAN SELECTOR - MAIN FAN	41982200	1	1003499	4014486469004
28	MAIN FAN SELECTOR - MAIN FAN	41987900	1	1000575	4014486468847

### MF 29

1	FEEDER DRUM - COUNTERSHAFT	41983500	1	1000611	4014486469493
1	FEEDER DRUM - COUNTERSHAFT	41983600	1	1000611	4014486469493
2	CRANKSHAFT - COUNTERSHAFT	41963900	1	1000233	4014486463293
3	COUNTERSHAFT (UPPER) - FEEDER SHAFT	41989200	1	1000908	4014486473568
3	COUNTERSHAFT - UPPER BEATER SHAFT	41989400	1	1000911	4014486473605
4	FEEDER SHAFT (UPPER) - STRIPPER BEATER	41991700	1	1001844	4014486488739
7	INTERMEDIATE SHAFT - ECCENTRIC SHAFT	41982400	1	1003501	4014486469059
7	INTERMEDIATE SHAFT - ECCENTRIC SHAFT	41982500	1	1000585	4014486469066
8	AUGER - LOWER RETURN AUGER (GRAIN)	41990100	1	1001377	4014486474916
8	AUGER - LOWER RETURN AUGER (GRAIN)	41990400	1	1003581	4014486474930
9	COUNTER SELECTOR - INTERMEDIATE SHAFT	41987800	1	1000620	4014486469608
9	COUNTER SELECTOR - INTERMEDIATE SHAFT	41988000	1	1000698	4014486470802
10	STRIPPER BEATER - COUNTER SELECTOR	41934800	3	1002768	4014486465228
11	COUNTER SELECTOR - ENGINE	41993400	1	1003633	4014486488609



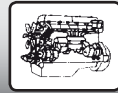

## MASSEY FERGUSON

12	ENGINE - HYDRAULIC PUMP	41929000	1	1000251	4014486463897
12	ENGINE - HYDRAULIC PUMP	41930200	1	1000260	4014486464108
12	ENGINE - HYDRAULIC PUMP	D41929000	1	1000251	4014486463897
13	COUNTER SELECTOR - COUNTER DRIVE STRAW CHOPPER	41942100	1	1000404	4014486466676
14	COUNTER DRIVE STRAW CHOPPER	41987300	1	1000815	4014486472400
15	AWNER SHAFT	41912300	1	1003380	4014486461749
15	AWNER SHAFT	41912400	1	1003381	4014486461732
16	COUNTER SELECTOR - THRESHING DRUM	41980900	1	1001526	4014486460452
16	COUNTER SELECTOR - THRESHING DRUM	D41980900	1	1001526	4014486460452
17	COUNTER SELECTOR - AWNER SHAFT	41990400	1	1003581	4014486474930
18	COUNTER SELECTOR - DISCHARGE AUGER	41936200	2	1002770	4014486465648
20	FILLING AUGER - STRIPPER BEATER	41982500	1	1000585	4014486469066
25	MAIN FAN VARIABLE SPEED DRIVE - STRIPPER BEATER	41987900	1	1000575	4014486468847
28	MAIN FAN SELECTOR - MAIN FAN	41982100	1	1000582	4014486469011
28	MAIN FAN SELECTOR - MAIN FAN	41982200	1	1003499	4014486469004
28	MAIN FAN VARIABLE SPEED DRIVE	41987900	1	1000575	4014486468847
<b>MF 30</b>					
1	STRIPPER BEATER - COUNTERSHAFT	41934800	3	1002768	4014486465228
2	COUNTERSHAFT (DIESEL ENGINE)	41990051	1	1001877	4014486489255
3	DISCHARGE AUGER SHAFT (DIESEL ENGINE)	41990050	1	1003600	4014486485196
5	COUNTERSHAFT - INTERMEDIATE DRIVE FOR STRAW	41942200	1	1000410	4014486466737
6	KNIFE DRIVE - COUNTERSHAFT	41985600	1	1000693	4014486470741
9	FEEDER SHAFT (UPPER) - STRIPPER BEATER	41991700	1	1001844	4014486488739
10	INTERMEDIATE SHAFT - ECCENTRIC SHAFT	41982100	1	1000582	4014486469011
11	INTERMEDIATE SHAFT - COUNTERSHAFT	41984100	1	1000655	4014486470185
12	INTERMEDIATE SHAFT - STRAW SHAKER CRANK	41990068	1	1001368	4014486474824
13	INTERMEDIATE SHAFT - STRAW CHOPPER	41978400	1	1001725	4014486487084
14	KNIFE DRIVE - COUNTERSHAFT	41986300	1	1000756	4014486471571
17	AIR CONDITIONING COMPRESSOR DRIVE	41991000	1	1002346	4014486478792
19	AIR CONDITIONING COMPRESSOR DRIVE - SUCTION TRAINER	41990009	1	1002357	4014486478907
21	DISCHARGE AUGER SHAFT - INTERMEDIATE DRIVE - ELEVATOR	41979600	1	1003347	4014486486285
23	INTERMEDIATE SHAFT - FILL ELEVATOR - STRIP BEATER	41950100	1	1000627	4014486469776
25	COUNTERSHAFT - GRAIN SEPARATOR	41982100	1	1000582	4014486469011
26	MAIN FAN VARIABLE SPEED DRIVE	41982100	1	1000582	4014486469011
27	MAIN FAN VARIABLE SPEED DRIVE - STRIPPER BEATER	41987900	1	1000575	4014486468847
28	COUNTERSHAFT - THRESHING DRUM	41980900	1	1001526	4014486460452
28	COUNTERSHAFT - THRESHING DRUM	D41980900	1	1001526	4014486460452
29	MAIN FAN VARIABLE SPEED DRIVE - RETURN ELEVATOR	41950400	1	1003517	4014486469691
<b>MF 31</b>					
1	COUNTERSHAFT - FEEDER DRUM	41983500	1	1000611	4014486469493
1	COUNTERSHAFT - FEEDER DRUM	41983600	1	1000611	4014486469493
2	COUNTERSHAFT - CRANKSHAFT	41963900	1	1000233	4014486463293
3	COUNTERSHAFT - STRIPPER BEATER	41989200	1	1000908	4014486473568
3	COUNTERSHAFT - STRIPPER BEATER	41989400	1	1000911	4014486473605
4	FEEDER SHAFT (UPPER) - STRIPPER BEATER	41991700	1	1001844	4014486488739
7	INTERMEDIATE SHAFT - ECCENTRIC SHAFT	41982400	1	1003501	4014486469059
7	INTERMEDIATE SHAFT - ECCENTRIC SHAFT	41982500	1	1000585	4014486469066
8	AUGER - LOWER RETURN AUGER (GRAIN)	41990069	1	1001378	4014486474923
8	AUGER - LOWER RETURN AUGER (GRAIN)	41990100	1	1001377	4014486474916
8	AUGER - LOWER RETURN AUGER (GRAIN)	41990400	1	1003581	4014486474930
9	COUNTER SELECTOR - INTERMEDIATE SHAFT	41987800	1	1000620	4014486469608
9	COUNTER SELECTOR - INTERMEDIATE SHAFT	41988000	1	1000698	4014486470802
10	STRIPPER BEATER - COUNTER SELECTOR	41934800	3	1002768	4014486465228



## MASSEY FERGUSON

11	COUNTER SELECTOR - ENGINE	41991300	1	1001836	4014486488616
11	COUNTER SELECTOR - ENGINE	41993400	1	1003633	4014486488609
12	ENGINE - HYDRAULIC PUMP	41930200	1	1000260	4014486464108
13	COUNTER SELECTOR - COUNTER DRIVE STRAW CHOPPER	41942100	1	1000404	4014486466676
14	COUNTER DRIVE STRAW CHOPPER	41987600	1	1000853	4014486472844
15	AWNER SHAFT	41912300	1	1003380	4014486461749
15	AWNER SHAFT	41912400	1	1003381	4014486461732
16	COUNTER SELECTOR - THRESHING DRUM	41980900	1	1001526	4014486460452
16	COUNTER SELECTOR - THRESHING DRUM	D41980900	1	1001526	4014486460452
17	COUNTER SELECTOR - AWNER SHAFT	41990069	1	1001378	4014486474923
17	COUNTER SELECTOR - AWNER SHAFT	41990400	1	1003581	4014486474930
18	COUNTER SELECTOR - DISCHARGE AUGER	41936200	2	1002770	4014486465648
20	FILLING AUGER - STRIPPER BEATER	41982500	1	1000585	4014486469066
25	MAIN FAN SELECTOR - STRIPPER BEATER	41987900	1	1000575	4014486468847
28	MAIN FAN SELECTOR - MAIN FAN	41982100	1	1000582	4014486469011
28	MAIN FAN SELECTOR - MAIN FAN	41982200	1	1003499	4014486469004
28	MAIN FAN SELECTOR - MAIN FAN	41987900	1	1000575	4014486468847

### MF 32

1	STRIPPER BEATER - COUNTERSHAFT	41934800	3	1002768	4014486465228
2	COUNTERSHAFT (DIESEL ENGINE)	41990051	1	1001877	4014486489255
3	DISCHARGE AUGER SHAFT (DIESEL ENGINE)	41990050	1	1003600	4014486485196
5	COUNTERSHAFT - INTERMEDIATE DRIVE FOR STRAW	41942200	1	1000410	4014486466737
6	KNIFE DRIVE - COUNTERSHAFT	41985600	1	1000693	4014486470741
9	FEEDER SHAFT (UPPER) - STRIPPER BEATER	41991700	1	1001844	4014486488739
10	INTERMEDIATE SHAFT - ECCENTRIC SHAFT	41982100	1	1000582	4014486469011
11	INTERMEDIATE SHAFT - COUNTERSHAFT	41984100	1	1000655	4014486470185
12	INTERMEDIATE SHAFT - STRAW SHAKER CRANK	41990068	1	1001368	4014486474824
13	INTERMEDIATE SHAFT - STRAW CHOPPER	41978400	1	1001725	4014486487084
14	KNIFE DRIVE - COUNTERSHAFT	41986300	1	1000756	4014486471571
17	AIR CONDITIONING COMPRESSOR DRIVE	41991000	1	1002346	4014486478792
19	AIR CONDITIONING COMPRESSOR DRIVE - SUCTION TRAINER	41990009	1	1002357	4014486478907
21	DISCHARGE AUGER SHAFT - INTERMEDIATE DRIVE - ELEVATOR	41979600	1	1003347	4014486486285
23	INTERMEDIATE SHAFT - FILL ELEVATOR - STRIP BEATER	41950100	1	1000627	4014486469776
25	COUNTERSHAFT - GRAIN SEPARATOR	41982100	1	1000582	4014486469011
26	MAIN FAN VARIABLE SPEED DRIVE	41982100	1	1000582	4014486469011
27	MAIN FAN VARIABLE SPEED DRIVE - STRIPPER BEATER	41987900	1	1000575	4014486468847
28	COUNTERSHAFT - THRESHING DRUM	41980900	1	1001526	4014486460452
28	COUNTERSHAFT - THRESHING DRUM	D41980900	1	1001526	4014486460452
29	MAIN FAN VARIABLE SPEED DRIVE - RETURN ELEVATOR	41950400	1	1003517	4014486469691

### MF 34

11		41979800	1	1001990	4014486491104
12		41990001	1	1002212	4014486477634
29		41981000	1	1001539	4014486460582

### MF 38

1	STRIPPER BEATER - COUNTERSHAFT	41979900	1	1003576	4014486492217
3	DISCHARGE AUGER SHAFT (DIESEL ENGINE)	41979100	1	1001607	4014486485332
5	COUNTERSHAFT - INTERMEDIATE DRIVE FOR STRAW	41979600	1	1003347	4014486486285
6	INTERMEDIATE SHAFT - STRAW CHOPPER	41978900	1	1001730	4014486487145
7	KNIFE DRIVE - COUNTERSHAFT	41985600	1	1000693	4014486470741
10	STRIPPER BEATER	41979800	1	1001990	4014486491104
11	STRIPPER BEATER - INTERMEDIATE SHAFT	41990001	1	1002212	4014486477634
12	INTERMEDIATE SHAFT - ECCENTRIC SHAFT	41933700	2	1002760	4014486464993



# MASSEY FERGUSON

13	INTERMEDIATE SHAFT - STRAW SHAKER CRANK	41979000	1	1001632	4014486485776
14	KNIFE DRIVE - COUNTERSHAFT	41986300	1	1000756	4014486471571
17	SUCTION TRAINER - DUST EXTRACTOR	41911000	1	1000143	4014486461619
19	INTERMEDIATE SHAFT - FILL ELEVATOR	41986100	1	1000675	4014486470475
19	INTERMEDIATE SHAFT - FILL ELEVATOR	D41986100	1	1000675	4014486470475
20	DUST EXTRACTOR - FILL ELEVATOR	41998800	1	1000278	4014486464528
23	DISCHARGE AUGER SHAFT	41978800	1	1001683	4014486486544
25	AIR CONDITIONING COMPRESSOR DRIVE	41909000	1	1003748	4014486496048
27	MAIN FAN VARIABLE SPEED DRIVE - STRIPPER BEATER	41981200	1	1001427	4014486459357
27	MAIN FAN VARIABLE SPEED DRIVE - STRIPPER BEATER	D41981200	1	1001427	4014486459357
28	MAIN FAN VARIABLE SPEED DRIVE	41981100	1	1001436	4014486459449
28	MAIN FAN VARIABLE SPEED DRIVE	D41981100	1	1001436	4014486459449
29	STRIPPER BEATER - INTERMEDIATE DRIVE VARIATOR	41981000	1	1001539	4014486460582
30	INTERMEDIATE SHAFT - VARIATOR DRIVE THRESHING DRUM	41985200	1	1000603	4014486469370
31	INTERMEDIATE SHAFT - VARIATOR DRIVE THRESHING DRUM	41985300	1	1003514	4014486469622

AG - BI  
CA - CL  
DE - DR  
FE - FO  
GO - GR  
IN - JO  
KP - KZ  
LA - ME  
NE - RO  
SA - ST  
VA - ZM  
PARTS  
SERVICE



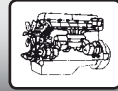

## MENGELE

	04-109135	1	1002019	4014486491548
	98-006272	1	1003465	4014486467208
	98-011048	1	1000466	4014486467376
	98-014367	1	1000206	4014486462463
	98-017686	1	1000473	4014486467444
	98-017967	3	1002214	4014486477658
	98-018167	1	1002452	4014486493337
	98-020849	1	1003466	4014486467307
	98-021123	1	1002562	4014486495157
	98-022200	1	1000136	4014486461534
	98-022265	1	1000472	4014486467437
	98-022731	1	1000138	4014486461558
	98-023422	1	1003625	4014486488081
	98-024340	1	1000442	4014486467093
	98-025521	1	1002045	4014486475210
	98-026937	1	1003387	4014486462487
	98-028264	1	1000473	4014486467444
	98-028266	1	1000466	4014486467376
	98-028267	1	1000469	4014486467406
	98-028268	1	1000470	4014486467413
	98-028271	1	1000458	4014486467277
	98-028534	1	1001252	4014486492088
	98-029383	2	1002942	4014486493474
	98-029384	2	1002487	4014486493894
	98-031590	1	1001847	4014486488777
	98-031801	1	1001855	4014486488906
	98-031803	1	1001899	4014486489583
	98-036045	1	1001896	4014486489552
	98-036276	1	1001258	4014486492156
	98-036317	1	1001010	4014486487923
	98-039776	1	1001265	4014486492309
	98-039955	1	1001895	4014486489545
	98-041405	1	1000562	4014486468625
	98-041414	1	1001550	4014486484496
	98-041435	1	1002021	4014486491562
	98-041779	1	1001897	4014486489569
	98-042197	1	1001257	4014486492149
	98-042202	4	1003035	4014486477429
	98-042380	4	1002301	4014486479898
	98-042442	1	1001880	4014486489309
	98-042619	2	1002042	4014486475173
	98-043775	1	1001908	4014486489705
	98-043776	1	1001904	4014486489644
	98-043777	1	1001906	4014486489682
	98-043929	1	1000559	4014486468564

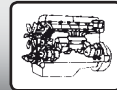
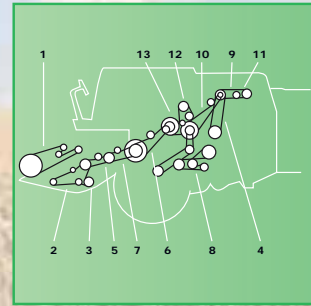
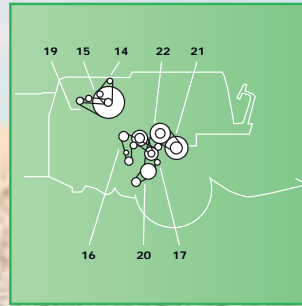
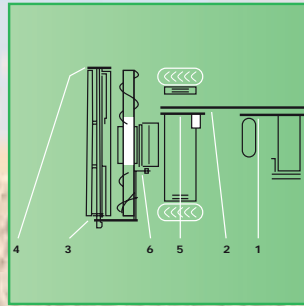
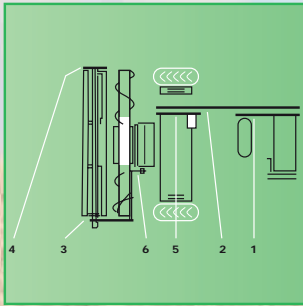

## NEW HOLLAND

### 1520

1	REEL DRIVE	80333255	1	1000775	4014486471847
2	KNIFE DRIVE	337415	1	1000625	4014486469738
2	KNIFE DRIVE	80337415	1	1000625	4014486469738
3	REEL DRIVE VARIABLE SPEED	80334065	1	1001403	4014486459098
4	INTERMEDIATE SHAFT - KNIFE	80330715	1	1000726	4014486471182
5	STRAW ELEVATOR DRIVE	80230059	1	1000654	4014486470178
8	HYDRAULIC PUMP DRIVE	80230043	1	1003400	4014486462906
10	ECCENTRIC DRIVE	80230061	1	1000717	4014486471076
11	STRAW WALKER	80230046	1	1004468	4014486712124
12	FAN DRIVE (DEUTZ ENGINE)	80327040	1	1002267	4014486478358
14	FAN BELT (FORD ENG)	80371222	1	1002547	4014486494778
15	TAILINGS ELEVATOR	80230046	1	1004468	4014486712124
16	UNLOADING SYSTEM	80326298	1	1003489	4014486468427
17	DRUM DRIVE VARIABLE SPEED	80230078	1	1001509	4014486460254
18	FAN DRIVE VARIABLE SPEED	330204	1	1000243	4014486463613
18	FAN DRIVE VARIABLE SPEED	80330204	1	1000243	4014486463613

### 1530

1	REEL DRIVE	80333255	1	1000775	4014486471847
2	KNIFE DRIVE	80337415	1	1000625	4014486469738
3	REEL DRIVE VARIABLE SPEED	80334065	1	1001403	4014486459098
4	INTERMEDIATE KNIFE DRIVE	80330715	1	1000726	4014486471182
5	STRAW ELEVATOR DRIVE	80230073	1	1000904	4014486473506
6	ECCENTRIC SHAFT DRIVE	80230060	1	1003534	4014486470536
9	HYDRAULIC PUMP DRIVE	80230043	1	1003400	4014486462906
11	FAN DRIVE (DEUTZ ENGINE)	80336386	1	1000027	4014486483482
12	ALTERNATOR DRIVE (DEUTZ ENGINE)	386155	1	1000022	4014486483420
12	ALTERNATOR DRIVE (DEUTZ ENGINE)	80336426	1	1000020	4014486483390
12	ALTERNATOR DRIVE (DEUTZ ENGINE)	80386155	1	1000022	4014486483420
13	FAN BELT (FORD ENG)	80371222	1	1002547	4014486494778
14	ELEVATOR DRIVE GRAIN	80230059	1	1000654	4014486470178
16	TAILINGS ELEVATOR DRIVE	80230057	1	1000603	4014486469370
18	UNLOADING SYSTEM	80230103	1	1000881	4014486473216
19	DRUM DRIVE VARIABLE SPEED	80230078	1	1001509	4014486460254
20	FAN DRIVE VARIABLE SPEED	80230056	1	1003232	4014486518658
21	STRAW WALKER - ECCENTRIC	80230108	1	1003452	4014486465617

### 1540

1	REEL DRIVE	80333255	1	1000775	4014486471847
2	KNIFE DRIVE	80337415	1	1000625	4014486469738
3	REEL DRIVE VARIABLE SPEED	80334065	1	1001403	4014486459098
4	SICKLE KNIFE DRIVE	80362500	2	1002788	4014486466201
5	DRUM DRIVE VARIABLE SPEED	80336784	1	1001506	4014486460216
7	MAIN SHAFT DRIVE	80323646	1	1001949	4014486490541
8	UNLOADING SYSTEM	80333958	1	1000715	4014486471052
9	DRUM DRIVE VARIABLE SPEED	80336784	1	1001506	4014486460216
12	ELEVATOR DRIVE GRAIN	80230164	1	1000622	4014486469660
12	GRAIN ELEVATOR DRIVE	80353584	1	1000734	4014486471281
14	TAILINGS ELEVATOR DRIVE	80323413	1	1000577	4014486468922
16	FAN DRIVE	80230059	1	1000654	4014486470178
19	DEUTZ ENGINE	80336386	1	1000027	4014486483482
19	FAN BELT (FORD ENG)	80371222	1	1002547	4014486494778
19	DEUTZ ENGINE	80386155	1	1000022	4014486483420

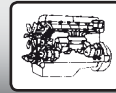
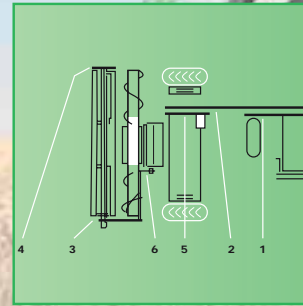
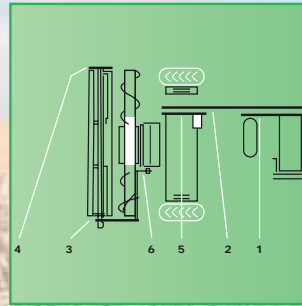
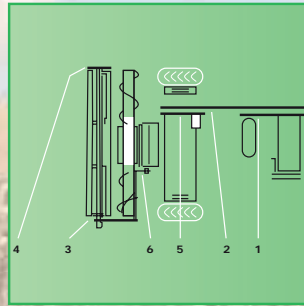
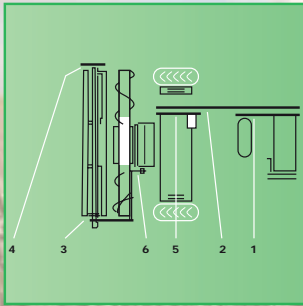

## NEW HOLLAND

0	HYDRAULIC PUMP DRIVE	80350236	1	1003640	4014486489002
<b>1545</b>					
1	REEL DRIVE	80333255	1	1000775	4014486471847
2	KNIFE DRIVE	80337415	1	1000625	4014486469738
3	REEL DRIVE VARIABLE SPEED	80334065	1	1001403	4014486459098
5	STRAW ELEVATOR DRIVE	80230073	1	1000904	4014486473506
6	ECCENTRIC SHAFT DRIVE	80230060	1	1003534	4014486470536
9	HYDRAULIC PUMP DRIVE	80230043	1	1003400	4014486462906
11	STRAW WALKER DRIVE	80230108	1	1003452	4014486465617
12	FAN BELT (FORD ENG)	80371222	1	1002547	4014486494778
13	ELEVATOR DRIVE GRAIN	80230059	1	1000654	4014486470178
14	TAILINGS ELEVATOR DRIVE	80230057	1	1000603	4014486469370
16	DRUM DRIVE VARIABLE SPEED	80230078	1	1001509	4014486460254
17	FAN DRIVE VARIABLE SPEED	80230056	1	1003232	4014486518658
<b>1550</b>					
1	REEL DRIVE	80333255	1	1000775	4014486471847
2	KNIFE DRIVE	80337415	1	1000625	4014486469738
3	REEL DRIVE VARIABLE SPEED	80334065	1	1001403	4014486459098
4	INTERMEDIATE SHAFT. KNIFE	80362500	2	1002788	4014486466201
5	DRUM DRIVE VARIABLE SPEED	80336784	1	1001506	4014486460216
6	HYDRAULIC PUMP DRIVE	80230043	1	1003400	4014486462906
7	MAIN SHAFT DRIVE	80323646	1	1001949	4014486490541
8	UNLOADING SYSTEM	80333958	1	1000715	4014486471052
9	DRUM DRIVE VARIABLE SPEED	80336784	1	1001506	4014486460216
10	GROUND SPEED DRIVE	80356025	1	1001525	4014486460445
11	GROUND SPEED VARIATOR DRIVE	80356025	1	1001525	4014486460445
14	ELEVATOR DRIVE GRAIN	80230164	1	1000622	4014486469660
16	TAILINGS ELEVATOR DRIVE	80323413	1	1000577	4014486468922
21	GRAIN ELEVATOR DRIVE	80353584	1	1000734	4014486471281
<b>8030</b>					
2	FORD ENGINE	80443634	1	1002543	4014486494723
6	DRUM DRIVE VARIABLE SPEED	80336784	1	1001506	4014486460216
7	FAN DRIVE VARIABLE SPEED	80230057	1	1000603	4014486469370
8	FAN DRIVE VARIABLE SPEED	80395955	1	1000555	4014486468496
9	STRAW WALKER - ECCENTRIC	80431784	1	1000328	4014486465587
13	ELEVATOR DRIVE UNIT	80422731	1	1000696	4014486470772
15	ECCENTRIC DRIVE	80387469	1	1000700	4014486470833
16	STRAW ELEVATOR DRIVE	80066232	1	1000690	4014486470697
17	HEADER DRIVE	80330715	1	1000726	4014486471182
<b>8040</b>					
2	ALTERNATOR AND WATERPUMP DRIVE	80443634	1	1002543	4014486494723
2	ALTERNATOR AND WATERPUMP DRIVE	80443636	2	1002935	4014486493443
5	DRUM DRIVE VARIABLE SPEED	80336784	1	1001506	4014486460216
7	CLEANING FAN DRIVE (UPPER)	80230057	1	1000603	4014486469370
8	FAN CLEANING DRIVE (LOWER)	80395955	1	1000555	4014486468496
9	STRAW WALKER DRIVE	80431784	1	1000328	4014486465587
13	ELEVATOR BOTTOM AUGER (GRAIN)	80422731	1	1000696	4014486470772
15	ECCENTRIC SHAFT DRIVE	80387469	1	1000700	4014486470833
16	STRAW ELEVATOR DRIVE	80066232	1	1000690	4014486470697
17	HEADER DRIVE	80330715	1	1000726	4014486471182
19	INTERMEDIATE SHAFT - FAN	80427456	1	1003351	4014486464603

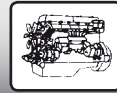
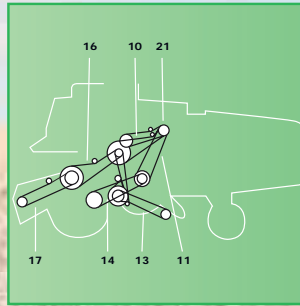
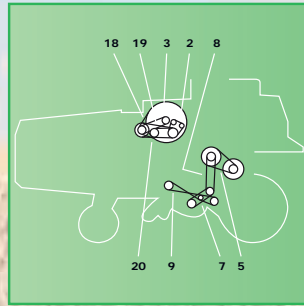
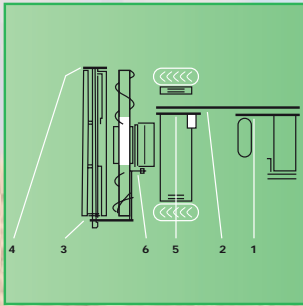

## NEW HOLLAND

21	AUGER BOTTOM GRAIN TANK	80230164	1	1000622	4014486469660
----	-------------------------	----------	---	---------	---------------

### 8050

1	REEL DRIVE	80333255	1	1000775	4014486471847
2	KNIFE DRIVE	80337415	1	1000625	4014486469738
3	REEL DRIVE VARIABLE SPEED	80334065	1	1001403	4014486459098
5	BEATER DRUM DRIVE	80451481	1	1001946	4014486490480
6	STRAW ELEVATOR DRIVE	80393326	1	1003323	4014486485677
7	INTERMEDIATE DRIVE	80397297	1	1001858	4014486488937
8	STRAW SHAKER	80605529	1	1000366	4014486466287
9	GROUND SPEED DRIVE (STANDARD SPEED)	80424318	1	1001467	4014486459777
10	STRAW WALKER DRIVE	605529	1	1000366	4014486466287
12	DISCHARGE AUGER	80410896	1	1000567	4014486468748
14	GROUND SPEED DRIVE	80230077	1	1001489	4014486459999
14	SPEED VARIATOR DRIVE	80356024	1	1001489	4014486459999
14	FAN BELT (FORD ENG)	80371222	1	1002547	4014486494778
15	FAN DRIVE	80399058	1	1002599	4014486496055
17	TAILINGS AUGER (SUPERIOR) (GRAIN)	80387469	1	1000700	4014486470833
18	FAN DRIVE	80378989	2	1002821	4014486463606
19	FAN DRIVE	80388280	1	1001410	4014486459173
20	DRUM DRIVE VARIABLE SPEED	80336784	1	1001506	4014486460216
21	BEATER DRIVE 8050 (201 = 4406001 - 4411999)	80396750	2	1002880	4014486468915
21	BEATER DRIVE 8050 (30 = 4412001 - ...)	80437033	2	1002878	4014486468991
22	INTERMEDIATE SHAFT - BEATER DRIVE	80395955	1	1000555	4014486468496

### 8055

2	ALTERNATOR AND WATERPUMP DRIVE (FORD ENGINE)	80443634	1	1002543	4014486494723
5	DRUM DRIVE VARIABLE SPEED	80336784	1	1001506	4014486460216
7	FAN DRIVE	80230057	1	1000603	4014486469370
8	FAN DRIVE	80395955	1	1000555	4014486468496
9	STRAW WALKER DRIVE	80431784	1	1000328	4014486465587
10	BEATER DRIVE	80447031	1	1001872	4014486489132
13	ELEVATOR BOTTOM AUGER (GRAIN)	80422731	1	1000696	4014486470772
15	ECCENTRIC SHAFT DRIVE	80387469	1	1000700	4014486470833
16	STRAW ELEVATOR DRIVE	80066232	1	1000690	4014486470697
16	STRAW ELEVATOR DRIVE	80424563	1	1001765	4014486487480
19	INTERMEDIATE SHAFT - DUST SCREEN DRIVE	80427456	1	1003351	4014486464603



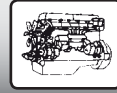
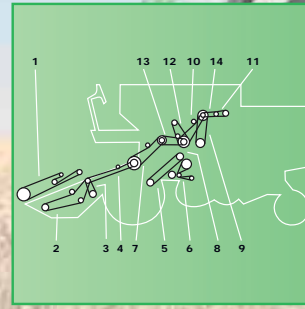
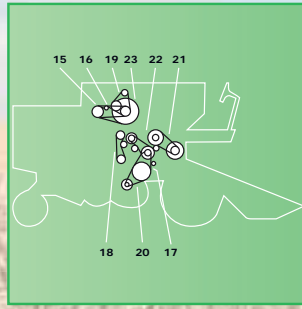
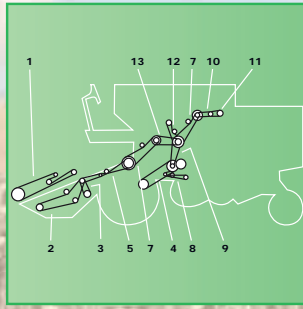
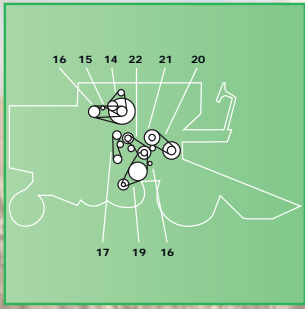

## NEW HOLLAND

### 8060

1	REEL DRIVE	80333255	1	1000775	4014486471847
2	KNIFE DRIVE	80337415	1	1000625	4014486469738
3	REEL DRIVE VARIABLE SPEED	80334065	1	1001403	4014486459098
6	STRAW ELEVATOR DRIVE	80393326	1	1003323	4014486485677
7	DRUM DRIVE VARIABLE SPEED	80397297	1	1001858	4014486488937
8	STRAW WALKER DRIVE	80605529	1	1000366	4014486466287
12	INTERMEDIATE SHAFT - AUGER (GRAIN)	80410896	1	1000567	4014486468748
14	ALTERNATOR DRIVE (FORD 2704 ET)	80371222	1	1002547	4014486494778
15	FAN DRIVE	80399058	1	1002599	4014486496055
17	TAILINGS AUGER (SUPERIOR) (GRAIN)	80387469	1	1000700	4014486470833
18	FAN DRIVE	80378989	2	1002821	4014486463606
19	FAN DRIVE	80388280	1	1001410	4014486459173
20	DRUM DRIVE VARIABLE SPEED	80336784	1	1001506	4014486460216
21	BEATER DRIVE 8060 (330 = 4313001 - 4321999)	80396750	2	1002880	4014486468915
21	BEATER DRIVE 8060 (40 = 4322001 - ...)	80437033	2	1002878	4014486468991
22	INTERMEDIATE SHAFT - BEATER DRIVE	80395955	1	1000555	4014486468496
-	GROUND SPEED DRIVE	80230077	1	1001489	4014486459999
-	SPEED VARIATOR DRIVE	80356024	1	1001489	4014486459999
-	GROUND SPEED DRIVE (STANDARD SPEED)	80424318	1	1001467	4014486459777
-	BEATER DRUM DRIVE	80451481	1	1001946	4014486490480

### 8070

1	REEL DRIVE	80333255	1	1000775	4014486471847
2	KNIFE DRIVE	80337415	1	1000625	4014486469738
3	REEL DRIVE VARIABLE SPEED	80334065	1	1001403	4014486459098
5	GROUND SPEED VARIATOR DRIVE	80356025	1	1001525	4014486460445
6	GROUND SPEED DRIVE (STANDARD SPEED) - PULLEY DIAMETER 404 MM	80321559	1	1001512	4014486460308
7	STRAW ELEVATOR DRIVE	80393326	1	1003323	4014486485677
8	STRAW WALKER DRIVE	80605529	1	1000366	4014486466287
9	HYDROSTATIC PUMP DRIVE	80411543	1	1003662	4014486490718
10	DRUM DRIVE VARIABLE SPEED	80391650	1	1001977	4014486490947
12	INTERMEDIATE SHAFT - AUGER (GRAIN)	80410896	1	1000567	4014486468748
13	RE-THRESHER DRIVE	80451481	1	1001946	4014486490480
15	FAN DRIVE (MERCEDES OM 401)	80384397	1	1004896	4014486740295
17	FAN DRIVE	80378989	2	1002821	4014486463606
18	TAILINGS ELEVATOR DRIVE	80387469	1	1000700	4014486470833
19	ALTERNATOR DRIVE (FORD 2704 ET)	80371222	1	1002547	4014486494778
20	FAN DRIVE VARIABLE SPEED	80388280	1	1001410	4014486459173
21	DRUM DRIVE VARIABLE SPEED	80387460	1	1001537	4014486460568
21	DRUM DRIVE VARIABLE SPEED	87621086	1	1001537	4014486460568
22	COUNTERSHAFT DRIVE	80396750	2	1002880	4014486468915
22	COUNTERSHAFT DRIVE	80437033	2	1002878	4014486468991
23	VARIATOR DRIVE	80395955	1	1000555	4014486468496

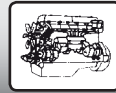
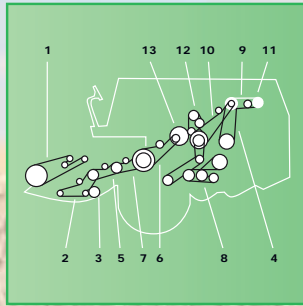
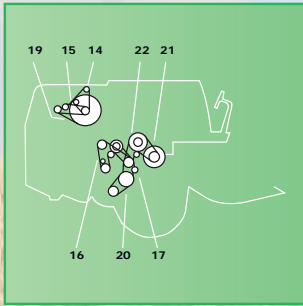

## NEW HOLLAND

### 8080

1	REEL DRIVE	80333255	1	1000775	4014486471847
2	KNIFE DRIVE	80337415	1	1000625	4014486469738
3	REEL DRIVE VARIABLE SPEED	80334065	1	1001403	4014486459098
4	HYDROSTATIC PUMP DRIVE	80411543	1	1003662	4014486490718
6	STRAW ELEVATOR DRIVE	80393326	1	1003323	4014486485677
7	HEADER DRIVE	80391142	2	1003838	4014486465563
7	HEADER DRIVE	80391143	2	1003838	4014486465563
8	STRAW WALKER DRIVE	80605529	1	1000366	4014486466287
10	DRUM DRIVE VARIABLE SPEED	80391650	1	1001977	4014486490947
12	INTERMEDIATE SHAFT - AUGER (GRAIN)	80410896	1	1000567	4014486468748
13	RE-THRESHER DRIVE	80451481	1	1001946	4014486490480
14	ALTERNATOR DRIVE (MERCEDES ENGINE OM 421)	80432642	1	1003746	4014486495928
15	FAN DRIVE (MERCEDES OM 401)	80384397	1	1004896	4014486740295
17	FAN DRIVE	80378989	2	1002821	4014486463606
18	TAILINGS ELEVATOR DRIVE	80387469	1	1000700	4014486470833
20	FAN DRIVE VARIABLE SPEED	80388280	1	1001410	4014486459173
21	DRUM DRIVE VARIABLE SPEED	80387460	1	1001537	4014486460568
22	COUNTERSHAFT DRIVE	80396750	2	1002880	4014486468915
22	COUNTERSHAFT DRIVE	80437033	2	1002878	4014486468991
23	VARIATOR DRIVE	80395955	1	1000555	4014486468496

### 9630

1	MAIN DRIVE	84017742	2	1001167	4014486491784
2	DRIVE	84026761	4	1002746	4014486461862
3	FAN DRIVE	84012975	2	1002087	4014486519129
4	ALTERNATOR DRIVE	84022807	1	1001132	4014486497168
5	COMPRESSOR DRIVE	80747177	1	1002582	4014486495638
5	COMPRESSOR DRIVE	89835815	1	1002588	4014486495812

### 9640

1	MAIN DRIVE	84017742	2	1001167	4014486491784
2	DRIVE	84026761	4	1002746	4014486461862
3	FAN DRIVE	84012975	2	1002087	4014486519129
4	ALTERNATOR DRIVE	84022807	1	1001132	4014486497168
5	COMPRESSOR DRIVE	80747177	1	1002582	4014486495638
5	COMPRESSOR DRIVE	89835815	1	1002588	4014486495812

### 9645

1	MAIN DRIVE	84017742	2	1001167	4014486491784
2	DRIVE	84026761	4	1002746	4014486461862
3	FAN DRIVE	84012975	2	1002087	4014486519129
4	ALTERNATOR DRIVE	84022807	1	1001132	4014486497168
5	COMPRESSOR DRIVE	80747177	1	1002582	4014486495638
5	COMPRESSOR DRIVE	89835815	1	1002588	4014486495812

### NEW HOLLAND

11		89814069	1	1001557	4014486484564
12		89593440	1	1000816	4014486472417
16		84004444	1	1001657	4014486486117
16	SELF LEVELING	84005417	1	1001655	4014486486094
		80445640	1	1000555	4014486468496
		89514989	1	1001679	4014486486483
		89817454	1	1000081	4014486484021

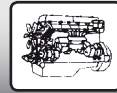

## NEW HOLLAND

		89832309	1	1001861	4014486488975
		89850770	1	1003992	4014486518689
		K68073	1	1002465	4014486493504

### 1540 AL

1	REEL DRIVE	80333255	1	1000775	4014486471847
2	KNIFE DRIVE	80337415	1	1000625	4014486469738
3	REEL DRIVE VARIABLE SPEED	80334065	1	1001403	4014486459098
4	SICKLE KNIFE DRIVE	80362500	2	1002788	4014486466201
5	DRUM DRIVE VARIABLE SPEED	80336784	1	1001506	4014486460216
7	MAIN SHAFT DRIVE	80323646	1	1001949	4014486490541
8	UNLOADING SYSTEM	80333958	1	1000715	4014486471052
9	DRUM DRIVE VARIABLE SPEED	80336784	1	1001506	4014486460216
12	ELEVATOR DRIVE GRAIN	80230164	1	1000622	4014486469660
12	GRAIN ELEVATOR DRIVE	80353584	1	1000734	4014486471281
14	TAILINGS ELEVATOR DRIVE	80323413	1	1000577	4014486468922
16	FAN DRIVE	80230059	1	1000654	4014486470178
19	DEUTZ ENGINE	80336386	1	1000027	4014486483482
19	DEUTZ ENGINE	80386155	1	1000022	4014486483420
0	HYDRAULIC PUMP DRIVE	80350236	1	1003640	4014486489002

### CR 9060

2	STRAW ELEVATOR DRIVE 4HB	84072421	1	1002036	4014486491722
4	UNLOADING AUGER	87011585	1	1001636	4014486485844
5	MAIN DRIVE	87580097	1	1001978	4014486490954
6	CHOPPER DRIVE	87580100	1	1004127	4014486523096
7	BEATER DRIVE	87580099	1	1001627	4014486485660
8	BEATER DRIVE	86566287	1	1000532	4014486518818
9	SHAKER SHOE DRIVE - SELF-LEVELLING	84056913	2	1000265	4014486464207
10	CHOPPER DRIVE	87526022	1	1004128	4014486523102
11	AIR CONDITIONER UNIT : MOUNTING GROUP - WITHOUT HEATING	84818007	1	1002621	4014486480146
12	DRIVE, ROTARY SCREEN AND FAN	445930	1	1002074	4014486475623
13	DRIVE, ROTARY SCREEN AND FAN	84057085	1	1000175	4014486462036
14	DRIVE, ROTARY SCREEN AND FAN	87556830	1	1004157	4014486523362
16	FEEDER DRIVE	86589482	1	1001914	4014486489774
17	TAILINGS ELEVATORS, BOTTOM AUGER AND (RH)	84058339	2	1000200	4014486462388
18	GRAIN ELEVATOR , DRIVE	87319821	1	1004066	4014486519396
19	FAN VARI-DRIVE	84817627	1	1001135	4014486497199

### CR 9060 ELEVATION

2	STRAW ELEVATOR DRIVE 4HB	87545653	1	1004148	4014486523294
4	UNLOADING AUGER	87011585	1	1001636	4014486485844
5	MAIN DRIVE	87545651	1	1004150	4014486523317
6	CHOPPER DRIVE	87557181	1	1004139	4014486523195
7	BEATER DRIVE	87546479	1	1001636	4014486485844
8	BEATER DRIVE	87315599	1	1004066	4014486519396
9	SHAKER SHOE DRIVE - SELF-LEVELLING	87325684	2	1004179	4014486523034
10	CHOPPER DRIVE	87526022	1	1004128	4014486523102
11	AIR CONDITIONER UNIT : MOUNTING GROUP, UNTIL BSN C 603	84818007	1	1002621	4014486480146
12	ROTARY SCREEN DRIVE AND FAN	87284244	2	1004162	4014486523409
13	DRIVE, ROTARY SCREEN AND FAN	84057085	1	1000175	4014486462036
13	DRIVE, ROTARY SCREEN AND FAN, UNTIL BSN C 599	84057085	1	1000175	4014486462036
13	DRIVE, ROTARY SCREEN AND FAN, FROM ASN D 600	87664428	1	1004111	4014486522860
14	ALTERNATOR DRIVE	747177	1	1002582	4014486495638
16	HYDRAULIC FAN DRIVE	87636309	1	1004115	4014486522907



## NEW HOLLAND

17	FEEDER DRIVE	86589482	1	1001914	4014486489774
18	TAILINGS ELEVATORS, BOTTOM AUGER AND (RH)	84058339	2	1000200	4014486462388
19	GRAIN ELEVATOR , DRIVE	87319821	1	1004066	4014486519396

### CR 9070 ELEVATION

2	STRAW ELEVATOR DRIVE 4HB	87545653	1	1004148	4014486523294
4	UNLOADING AUGER	87011585	1	1001636	4014486485844
5	MAIN DRIVE	87545651	1	1004150	4014486523317
6	CHOPPER DRIVE	87557181	1	1004139	4014486523195
7	BEATER DRIVE	87546479	1	1001636	4014486485844
8	BEATER DRIVE	87315599	1	1004066	4014486519396
9	SHAKER SHOE DRIVE - SELF-LEVELLING	87325684	2	1004179	4014486523034
10	CHOPPER DRIVE	87526022	1	1004128	4014486523102
11	AIR CONDITIONER UNIT : MOUNTING GROUP, UNTIL BSN C 603	84818007	1	1002621	4014486480146
11	AIR CONDITIONER UNIT : MOUNTING GROUP - WITHOUT HEATING, FROM ASN D 604	84818008	1	1004045	4014486519280
12	ROTARY SCREEN DRIVE AND FAN	87284244	2	1004162	4014486523409
13	DRIVE, ROTARY SCREEN AND FAN, UNTIL BSN C 599	84057085	1	1000175	4014486462036
13	DRIVE, ROTARY SCREEN AND FAN, ASN D 600	87664428	1	1004111	4014486522860
14	ALTERNATOR DRIVE	747177	1	1002582	4014486495638
15	ROTOR VARIATOR	87676816	1	No AP	
16	HYDRAULIC FAN DRIVE	87636309	1	1004115	4014486522907
17	FEEDER DRIVE	86589482	1	1001914	4014486489774
18	TAILINGS ELEVATORS, BOTTOM AUGER AND (RH)	84058339	2	1000200	4014486462388
19	GRAIN ELEVATOR , DRIVE	87319821	1	1004066	4014486519396

### CR 9080

2	STRAW ELEVATOR DRIVE 4HB	84072421	1	1002036	4014486491722
4	UNLOADING AUGER	87011585	1	1001636	4014486485844
5	MAIN DRIVE	87580097	1	1001978	4014486490954
6	CHOPPER DRIVE	87580100	1	1004127	4014486523096
7	BEATER DRIVE	87580099	1	1001627	4014486485660
8	BEATER DRIVE	86566287	1	1000532	4014486518818
9	SHAKER SHOE DRIVE - SELF-LEVELLING	84056913	2	1000265	4014486464207
10	CHOPPER DRIVE	87526022	1	1004128	4014486523102
11	AIR CONDITIONER UNIT : MOUNTING GROUP - WITHOUT HEATING	84818008	1	1004045	4014486519280
12	DRIVE, ROTARY SCREEN AND FAN	445930	1	1002074	4014486475623
13	DRIVE, ROTARY SCREEN AND FAN	84057085	1	1000175	4014486462036
14	DRIVE, ROTARY SCREEN AND FAN	87556830	1	1004157	4014486523362
15	ROTOR VARIATOR	87053803	1	No AP	
16	FEEDER DRIVE	86589482	1	1001914	4014486489774
17	TAILINGS ELEVATORS, BOTTOM AUGER AND (RH)	84058339	2	1000200	4014486462388
18	GRAIN ELEVATOR , DRIVE	87319821	1	1004066	4014486519396
19	FAN VARI-DRIVE	84817627	1	1001135	4014486497199

### CR 9080 ELEVATION

2	STRAW ELEVATOR DRIVE 4HB	87545653	1	1004148	4014486523294
4	UNLOADING AUGER	87011585	1	1001636	4014486485844
5	MAIN DRIVE	87545651	1	1004150	4014486523317
6	CHOPPER DRIVE	87557181	1	1004139	4014486523195
7	BEATER DRIVE	87546479	1	1001636	4014486485844
8	BEATER DRIVE	87315599	1	1004066	4014486519396
9	SHAKER SHOE DRIVE - SELF-LEVELLING	87325684	2	1004179	4014486523034
10	CHOPPER DRIVE	87526022	1	1004128	4014486523102
11	AIR CONDITIONER UNIT : MOUNTING GROUP, UNTIL BSN C 603	84818007	1	1002621	4014486480146

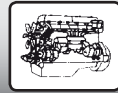

## NEW HOLLAND

11	AIR CONDITIONER UNIT : MOUNTING GROUP - WITHOUT HEATING, FROM ASN D 604	84818008	1	1004045	4014486519280
12	ROTARY SCREEN DRIVE AND FAN	87284244	2	1004162	4014486523409
13	ROTARY DUST SCREEN DRIVE	9513136	1	1004110	4014486522853
14	ALTERNATOR DRIVE	747177	1	1002582	4014486495638
16	HYDRAULIC FAN DRIVE	87636309	1	1004115	4014486522907
17	FEEDER DRIVE	86589482	1	1001914	4014486489774
18	TAILINGS ELEVATORS, BOTTOM AUGER AND (RH)	84058339	2	1000200	4014486462388
19	GRAIN ELEVATOR , DRIVE	87319821	1	1004066	4014486519396

<b>CR 960</b>					
2	STRAW ELEVATOR DRIVE 4HB	84072421	1	1002036	4014486491722
4	UNLOADING AUGER	87011585	1	1001636	4014486485844
5	MAIN DRIVE	87580097	1	1001978	4014486490954
6	CHOPPER DRIVE	84320963	1	1001646	4014486485981
7	BEATER DRIVE	87580099	1	1001627	4014486485660
8	BEATER DRIVE	86566287	1	1000532	4014486518818
9	SHAKER SHOE DRIVE - SELF-LEVELLING	84056913	2	1000265	4014486464207
10		84320963	1	1001646	4014486485981
12	DRIVE, ROTARY SCREEN AND FAN	445930	1	1002074	4014486475623
13	DRIVE, ROTARY SCREEN AND FAN	84057085	1	1000175	4014486462036
14	ALTERNATOR DRIVE	747177	1	1002582	4014486495638
16	FEEDER DRIVE	86589482	1	1001914	4014486489774
17	TAILINGS ELEVATORS, BOTTOM AUGER AND (RH)	84058339	2	1000200	4014486462388
18	GRAIN ELEVATOR, DRIVE	87319821	1	1004066	4014486519396
19	CLEANING FAN, FIXED SHOE, SIEVE FIXED	919739	1	1001136	4014486497205
19	FAN VARI-DRIVE	84817627	1	1001135	4014486497199

<b>CR 980</b>					
2	STRAW ELEVATOR DRIVE 4HB	84072421	1	1002036	4014486491722
4	UNLOADING AUGER	87011585	1	1001636	4014486485844
5	MAIN DRIVE	87580097	1	1001978	4014486490954
6	CHOPPER DRIVE	84320963	1	1001646	4014486485981
7	BEATER DRIVE	87580099	1	1001627	4014486485660
8	BEATER DRIVE	86566287	1	1000532	4014486518818
9	SHAKER SHOE DRIVE - SELF-LEVELLING	84056913	2	1000265	4014486464207
10		84320963	1	1001646	4014486485981
12	DRIVE, ROTARY SCREEN AND FAN	445930	1	1002074	4014486475623
13	DRIVE, ROTARY SCREEN AND FAN	84057085	1	1000175	4014486462036
14	ALTERNATOR DRIVE	747177	1	1002582	4014486495638
15	ROTOR VARIATOR	87053803	1	No AP	
16	FEEDER DRIVE	86589482	1	1001914	4014486489774
17	TAILINGS ELEVATORS, BOTTOM AUGER AND (RH)	84058339	2	1000200	4014486462388
18	GRAIN ELEVATOR, DRIVE	87319821	1	1004066	4014486519396
19	CLEANING FAN, FIXED SHOE, SIEVE FIXED	919739	1	1001136	4014486497205
19	FAN VARI-DRIVE	84817627	1	1001135	4014486497199

<b>CR960</b>					
	ALTERNATOR/WATERPUMP	500371653	1	1004473	4014486712162

<b>CS 520</b>					
1	ALTERNATOR, WATERPUMP AND AIR COMPRESSOR	84817638	1	1003807	4014486483048
2	MAIN TRANSMISSION	84993120	1	1002011	4014486491418
5	CHOPPER DRIVE	84076421	1	1001705	4014486486827
6	CHOPPER DRIVE	84075955	1	1003347	4014486486285

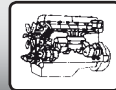

## NEW HOLLAND

7	GRASS SEED EQUIPMENT	84452153	1	1004044	4014486518313
8	GRASS SEED EQUIPMENT	84452112	1	1004114	4014486522891
9	ELEVATOR BOTTOM DRIVE GRAIN	80422731	1	1000696	4014486470772
10	FAN DRIVE VARIABLE SPEED	84073979	1	1001421	4014486459289
11	SHAKER SHOE DRIVE	84015531	1	1000601	4014486469332
12	STRAW WALKER DRIVE	84073276	1	1000340	4014486465877
13	DRUM DRIVE	84072772	1	1001237	4014486491913
13	DRUM DRIVE (LOW DRUM SPEED)	84072815	1	1001952	4014486490572
14	ROTARY SEPARATOR DRIVE AND SHAFT	84073933	1	1000566	4014486468731
15	DRUM DRIVE VARIABLE SPEED	84035748	1	1001316	4014486497892
16	STRAW ELEVATOR DRIVE 3HB	84982278	1	1001697	4014486486735
16	STRAW ELEVATOR DRIVE 2HB (FOR CS520 ONLY)	84991234	1	1001922	4014486489903
17	HEADER DRIVE ENGAGING IDLER (2HB ONLY)	84446792	1	1003326	4014486486087
18	AIR COMPRESSOR - BLOW-OFF SYSTEM	84061465	1	1002586	4014486495775
19	ROTARY SCREEN AND FAN	84061465	1	1002586	4014486495775
19	ROTARY SCREEN AND FAN	84989965	1	1000169	4014486461954
20	HYDROSTATIC PUMP DRIVE (NOT FOR CS660)	84607712	1	1001850	4014486488838
21	HYDRAULIC PUMP DRIVE	80427456	1	1003351	4014486464603
22	UNLOADING AUGER DRIVE	84991836	1	1000653	4014486470161

### CS 540

1	ALTERNATOR, WATERPUMP AND AIR COMPRESSOR	84817638	1	1003807	4014486483048
2	MAIN TRANSMISSION	84993120	1	1002011	4014486491418
5	CHOPPER DRIVE	84076421	1	1001705	4014486486827
6	CHOPPER DRIVE	84075955	1	1003347	4014486486285
7	GRASS SEED EQUIPMENT	84452153	1	1004044	4014486518313
8	GRASS SEED EQUIPMENT	84452112	1	1004114	4014486522891
9	ELEVATOR BOTTOM DRIVE GRAIN	80422731	1	1000696	4014486470772
10	FAN DRIVE VARIABLE SPEED	84073979	1	1001421	4014486459289
11	SHAKER SHOE DRIVE	84015531	1	1000601	4014486469332
12	STRAW WALKER DRIVE	84073276	1	1000340	4014486465877
13	DRUM DRIVE	84072772	1	1001237	4014486491913
13	DRUM DRIVE (LOW DRUM SPEED)	84072815	1	1001952	4014486490572
14	ROTARY SEPARATOR DRIVE AND SHAFT	84073933	1	1000566	4014486468731
15	DRUM DRIVE VARIABLE SPEED	84035748	1	1001316	4014486497892
16	STRAW ELEVATOR DRIVE 2HB (NOT FOR CS520)	84981586	1	1001720	4014486487022
16	STRAW ELEVATOR DRIVE 3HB	84982278	1	1001697	4014486486735
17	HEADER DRIVE ENGAGING IDLER (2HB ONLY)	84446792	1	1003326	4014486486087
17	HEADER DRIVE ENGAGING IDLER (3HB ONLY/NOT CS520)	89817374	1	1001876	4014486489231
18	AIR COMPRESSOR - BLOW-OFF SYSTEM	84061465	1	1002586	4014486495775
19	ROTARY SCREEN AND FAN	84061465	1	1002586	4014486495775
19	ROTARY SCREEN AND FAN	84989965	1	1000169	4014486461954
20	HYDROSTATIC PUMP DRIVE (NOT FOR CS660)	84607712	1	1001850	4014486488838
21	HYDRAULIC PUMP DRIVE	80427456	1	1003351	4014486464603
22	UNLOADING AUGER DRIVE	84991836	1	1000653	4014486470161

### CS 6050

2	STRAW ELEVATOR DRIVE, 2HB	84981586	1	1001720	4014486487022
2	STRAW ELEVATOR DRIVE, 3HB	84991234	1	1001922	4014486489903
3	HEADER DRIVE ENGAGING IDLER 2HB ONLY	84446792	1	1003326	4014486486087
3	HEADER DRIVE ENGAGING IDLER 3HB ONLY	89817374	1	1001876	4014486489231
4	DRUM VARIATOR	84035748	1	1001316	4014486497892
5	GRAIN TANK UNLOADING	84462590	1	1000653	4014486470161
6	MAIN DRIVE	84993120	1	1002011	4014486491418
7	HYDROSTATIC PUMP DRIVE	80427456	1	1003351	4014486464603

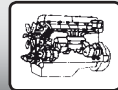

## NEW HOLLAND

8	HYDROSTATIC PUMP DRIVE	84607712	1	1001850	4014486488838
9	STRAW WALKER DRIVE	87521887	1	1000341	4014486465884
10	GRAIN ELEVATOR BOTTOM AUGER	80422731	1	1000696	4014486470772
13	CHOPPER DRIVE	84075955	1	1003347	4014486486285
14	CHOPPER DRIVE	84076421	1	1001705	4014486486827
15	DRIVE, ROTARY SCREEN AND FAN	84061465	1	1002586	4014486495775
16	DRIVE, ROTARY SCREEN AND FAN	84989965	1	1000169	4014486461954
17	ALTERNATOR DRIVE	747177	1	1002582	4014486495638
18	DRUM DRIVE	84072772	1	1001237	4014486491913
18	DRUM DRIVE, ROTATION SPEED SLOW	84072815	1	1001952	4014486490572
19	STRAW SHAKER DRIVE	84817635	1	1000601	4014486469332
20	FAN VARI-DRIVE	84073979	1	1001421	4014486459289
21	ROTARY SEPARATOR DRIVE AND SHAFT	84073933	1	1000566	4014486468731
22		84075955	1	1003347	4014486486285
23		84076421	1	1001705	4014486486827

### CS 6070

2	STRAW ELEVATOR DRIVE, 2HB	84981586	1	1001720	4014486487022
2	STRAW ELEVATOR DRIVE, 3HB	84991234	1	1001922	4014486489903
3	HEADER DRIVE ENGAGING IDLER 2HB ONLY	84446792	1	1003326	4014486486087
3	HEADER DRIVE ENGAGING IDLER 3HB ONLY	89817374	1	1001876	4014486489231
4	DRUM VARIATOR	84035748	1	1001316	4014486497892
5	GRAIN TANK UNLOADING	84462590	1	1000653	4014486470161
6	MAIN DRIVE	84993120	1	1002011	4014486491418
7	HYDROSTATIC PUMP DRIVE	80427456	1	1003351	4014486464603
8	HYDROSTATIC PUMP DRIVE	84607712	1	1001850	4014486488838
9	STRAW WALKER DRIVE	87521887	1	1000341	4014486465884
10	GRAIN ELEVATOR BOTTOM AUGER	80422731	1	1000696	4014486470772
13	CHOPPER DRIVE	84075955	1	1003347	4014486486285
14	CHOPPER DRIVE	84076421	1	1001705	4014486486827
15	DRIVE, ROTARY SCREEN AND FAN	84061465	1	1002586	4014486495775
16	DRIVE, ROTARY SCREEN AND FAN	84989965	1	1000169	4014486461954
17	ALTERNATOR DRIVE	747177	1	1002582	4014486495638
18	DRUM DRIVE	84072772	1	1001237	4014486491913
18	DRUM DRIVE, ROTATION SPEED SLOW	84072815	1	1001952	4014486490572
19	STRAW SHAKER DRIVE	84817635	1	1000601	4014486469332
20	FAN VARI-DRIVE	84073979	1	1001421	4014486459289
21	ROTARY SEPARATOR DRIVE AND SHAFT	84073933	1	1000566	4014486468731
22		84075955	1	1003347	4014486486285
23		84076421	1	1001705	4014486486827
25	CHAFF SPREADER	84790356	1	1004472	4014486712148

### CS 6080

2	STRAW ELEVATOR DRIVE, 2HB	84981586	1	1001720	4014486487022
2	STRAW ELEVATOR DRIVE, 3HB	84991234	1	1001922	4014486489903
3	HEADER DRIVE ENGAGING IDLER 2HB ONLY	84446792	1	1003326	4014486486087
3	HEADER DRIVE ENGAGING IDLER 3HB ONLY	89817374	1	1001876	4014486489231
4	DRUM VARIATOR	84035748	1	1001316	4014486497892
5	GRAIN TANK UNLOADING	84462590	1	1000653	4014486470161
6	MAIN DRIVE	84993120	1	1002011	4014486491418
7	HYDROSTATIC PUMP DRIVE	80427456	1	1003351	4014486464603
8	HYDROSTATIC PUMP DRIVE	84607712	1	1001850	4014486488838
9	STRAW WALKER DRIVE	87521887	1	1000341	4014486465884
10	GRAIN ELEVATOR BOTTOM AUGER	80422731	1	1000696	4014486470772
13	CHOPPER DRIVE	84075955	1	1003347	4014486486285



## NEW HOLLAND

14	CHOPPER DRIVE	84076421	1	1001705	4014486486827
15	DRIVE, ROTARY SCREEN AND FAN	84061463	2	1004160	4014486523386
16	DRIVE, ROTARY SCREEN AND FAN	87374615	1	1004049	4014486518436
17	ALTERNATOR DRIVE	84817626	1	1002579	4014486495560
18	DRUM DRIVE	84072772	1	1001237	4014486491913
18	DRUM DRIVE, ROTATION SPEED SLOW	84072815	1	1001952	4014486490572
19	STRAW SHAKER DRIVE	84817635	1	1000601	4014486469332
20	FAN VARI-DRIVE	84073979	1	1001421	4014486459289
21	ROTARY SEPARATOR DRIVE AND SHAFT	84073933	1	1000566	4014486468731
22		84075955	1	1003347	4014486486285
23		84076421	1	1001705	4014486486827
25	CHAFF SPREADER	84790356	1	1004472	4014486712148

### CS 6090

2	STRAW ELEVATOR DRIVE, 2HB	84981586	1	1001720	4014486487022
2	STRAW ELEVATOR DRIVE, 3HB	84991234	1	1001922	4014486489903
3	HEADER DRIVE ENGAGING IDLER 2HB ONLY	84446792	1	1003326	4014486486087
3	HEADER DRIVE ENGAGING IDLER 3HB ONLY	89817374	1	1001876	4014486489231
4	DRUM VARIATOR	84035748	1	1001316	4014486497892
5	GRAIN TANK UNLOADING	84462590	1	1000653	4014486470161
6	MAIN DRIVE	84993120	1	1002011	4014486491418
7	HYDROSTATIC PUMP DRIVE	80427456	1	1003351	4014486464603
8	HYDROSTATIC PUMP DRIVE	84607713	1	1001853	4014486488876
9	STRAW WALKER DRIVE	87521887	1	1000341	4014486465884
10	GRAIN ELEVATOR BOTTOM AUGER	80422731	1	1000696	4014486470772
13	CHOPPER DRIVE	84075955	1	1003347	4014486486285
14	CHOPPER DRIVE	84076421	1	1001705	4014486486827
15	DRIVE, ROTARY SCREEN AND FAN	84061463	2	1004160	4014486523386
16	DRIVE, ROTARY SCREEN AND FAN	87374615	1	1004049	4014486518436
17	ALTERNATOR DRIVE	84817626	1	1002579	4014486495560
18	DRUM DRIVE	84072772	1	1001237	4014486491913
18	DRUM DRIVE, ROTATION SPEED SLOW	84072815	1	1001952	4014486490572
19	STRAW SHAKER DRIVE	84817635	1	1000601	4014486469332
20	FAN VARI-DRIVE	84073979	1	1001421	4014486459289
21	ROTARY SEPARATOR DRIVE AND SHAFT	84073933	1	1000566	4014486468731
22		84075955	1	1003347	4014486486285
23		84076421	1	1001705	4014486486827
25	CHAFF SPREADER	84790356	1	1004472	4014486712148

### CS 640

1	ALTERNATOR, WATERPUMP AND AIR COMPRESSOR	84817638	1	1003807	4014486483048
2	MAIN TRANSMISSION	84993120	1	1002011	4014486491418
3	CHAFF SPREADER DRIVE (FOR CS640 AND CS660 ONLY)	84790356	1	1004472	4014486712148
5	CHOPPER DRIVE	84076421	1	1001705	4014486486827
6	CHOPPER DRIVE	84075955	1	1003347	4014486486285
7	GRASS SEED EQUIPMENT	84452153	1	1004044	4014486518313
8	GRASS SEED EQUIPMENT	84452112	1	1004114	4014486522891
9	ELEVATOR BOTTOM DRIVE GRAIN	80422731	1	1000696	4014486470772
10	FAN DRIVE VARIABLE SPEED	84073979	1	1001421	4014486459289
11	SHAKER SHOE DRIVE	84015531	1	1000601	4014486469332
12	STRAW WALKER DRIVE	84073276	1	1000340	4014486465877
13	DRUM DRIVE	84072772	1	1001237	4014486491913
13	DRUM DRIVE (LOW DRUM SPEED)	84072815	1	1001952	4014486490572
14	ROTARY SEPARATOR DRIVE AND SHAFT	84073933	1	1000566	4014486468731
15	DRUM DRIVE VARIABLE SPEED	84035748	1	1001316	4014486497892





## NEW HOLLAND

16	STRAW ELEVATOR DRIVE 2HB (NOT FOR CS520)	84981586	1	1001720	4014486487022
16	STRAW ELEVATOR DRIVE 3HB	84982278	1	1001697	4014486486735
17	HEADER DRIVE ENGAGING IDLER (2HB ONLY)	84446792	1	1003326	4014486486087
17	HEADER DRIVE ENGAGING IDLER (3HB ONLY/NOT CS520)	89817374	1	1001876	4014486489231
18	AIR COMPRESSOR - BLOW-OFF SYSTEM	84061465	1	1002586	4014486495775
19	ROTARY SCREEN AND FAN	84061465	1	1002586	4014486495775
19	ROTARY SCREEN AND FAN	84989965	1	1000169	4014486461954
20	HYDROSTATIC PUMP DRIVE (NOT FOR CS660)	84607712	1	1001850	4014486488838
21	HYDRAULIC PUMP DRIVE	80427456	1	1003351	4014486464603
22	UNLOADING AUGER DRIVE	84991836	1	1000653	4014486470161

### CS 660

1	ALTERNATOR, WATERPUMP AND AIR COMPRESSOR	84817638	1	1003807	4014486483048
2	MAIN TRANSMISSION	84993120	1	1002011	4014486491418
3	CHAFF SPREADER DRIVE (FOR CS640 AND CS660 ONLY)	84790356	1	1004472	4014486712148
5	CHOPPER DRIVE	84076421	1	1001705	4014486486827
6	CHOPPER DRIVE	84075955	1	1003347	4014486486285
7	GRASS SEED EQUIPMENT	84452153	1	1004044	4014486518313
8	GRASS SEED EQUIPMENT	84452112	1	1004114	4014486522891
9	ELEVATOR BOTTOM DRIVE GRAIN	80422731	1	1000696	4014486470772
10	FAN DRIVE VARIABLE SPEED	84073979	1	1001421	4014486459289
11	SHAKER SHOE DRIVE	84015531	1	1000601	4014486469332
12	STRAW WALKER DRIVE	84073276	1	1000340	4014486465877
13	DRUM DRIVE	84072772	1	1001237	4014486491913
13	DRUM DRIVE (LOW DRUM SPEED)	84072815	1	1001952	4014486490572
14	ROTARY SEPARATOR DRIVE AND SHAFT	84073933	1	1000566	4014486468731
15	DRUM DRIVE VARIABLE SPEED	84035748	1	1001316	4014486497892
16	STRAW ELEVATOR DRIVE 2HB (NOT FOR CS520)	84981586	1	1001720	4014486487022
16	STRAW ELEVATOR DRIVE 3HB	84982278	1	1001697	4014486486735
17	HEADER DRIVE ENGAGING IDLER (2HB ONLY)	84446792	1	1003326	4014486486087
17	HEADER DRIVE ENGAGING IDLER (3HB ONLY/NOT CS520)	89817374	1	1001876	4014486489231
18	AIR COMPRESSOR - BLOW-OFF SYSTEM	84061465	1	1002586	4014486495775
19	ROTARY SCREEN AND FAN	84061465	1	1002586	4014486495775
19	ROTARY SCREEN AND FAN	84989965	1	1000169	4014486461954
20	HYDROSTATIC PUMP DRIVE (FOR CS660 ONLY)	84607713	1	1001853	4014486488876
21	HYDRAULIC PUMP DRIVE	80427456	1	1003351	4014486464603
22	UNLOADING AUGER DRIVE	84991836	1	1000653	4014486470161

### CSX 7060

2	STRAW ELEVATOR DRIVE, 2HB	84981586	1	1001720	4014486487022
2	STRAW ELEVATOR DRIVE, 3HB	84991234	1	1001922	4014486489903
3	HEADER DRIVE ENGAGING IDLER 2HB ONLY	84446792	1	1003326	4014486486087
3	HEADER DRIVE ENGAGING IDLER 3HB ONLY	89817374	1	1001876	4014486489231
4	DRUM VARIATOR	84035748	1	1001316	4014486497892
5	GRAIN TANK UNLOADING	84462590	1	1000653	4014486470161
6	MAIN DRIVE	84993120	1	1002011	4014486491418
7	HYDROSTATIC PUMP DRIVE	80427456	1	1003351	4014486464603
8	HYDROSTATIC PUMP DRIVE	84607712	1	1001850	4014486488838
9	STRAW WALKER DRIVE	87521887	1	1000341	4014486465884
10	GRAIN ELEVATOR BOTTOM AUGER	80422731	1	1000696	4014486470772
13	CHOPPER DRIVE	84075955	1	1003347	4014486486285
14	CHOPPER DRIVE	84076421	1	1001705	4014486486827
15	DRIVE, ROTARY SCREEN AND FAN	84061463	2	1004160	4014486523386
16	DRIVE, ROTARY SCREEN AND FAN	87374615	1	1004049	4014486518436
17	ALTERNATOR DRIVE	84817626	1	1002579	4014486495560



## NEW HOLLAND

18	DRUM DRIVE	84072772	1	1001237	4014486491913
18	DRUM DRIVE, ROTATION SPEED SLOW	84072815	1	1001952	4014486490572
19	STRAW SHAKER DRIVE	84817635	1	1000601	4014486469332
20	FAN VARI-DRIVE	84073979	1	1001421	4014486459289
21	ROTARY SEPARATOR DRIVE AND SHAFT	84073933	1	1000566	4014486468731
22		84075955	1	1003347	4014486486285
23		84076421	1	1001705	4014486486827

### CSX 7080

2	STRAW ELEVATOR DRIVE, 2HB	84981586	1	1001720	4014486487022
2	STRAW ELEVATOR DRIVE, 3HB	84991234	1	1001922	4014486489903
3	HEADER DRIVE ENGAGING IDLER 2HB ONLY	84446792	1	1003326	4014486486087
3	HEADER DRIVE ENGAGING IDLER 3HB ONLY	89817374	1	1001876	4014486489231
4	DRUM VARIATOR	84035748	1	1001316	4014486497892
5	GRAIN TANK UNLOADING	84462590	1	1000653	4014486470161
6	MAIN DRIVE	84993120	1	1002011	4014486491418
7	HYDROSTATIC PUMP DRIVE	80427456	1	1003351	4014486464603
8	HYDROSTATIC PUMP DRIVE	84607713	1	1001853	4014486488876
9	STRAW WALKER DRIVE	87521887	1	1000341	4014486465884
10	GRAIN ELEVATOR BOTTOM AUGER	80422731	1	1000696	4014486470772
13	CHOPPER DRIVE	84075955	1	1003347	4014486486285
14	CHOPPER DRIVE	84076421	1	1001705	4014486486827
15	DRIVE, ROTARY SCREEN AND FAN	84061463	2	1004160	4014486523386
16	DRIVE, ROTARY SCREEN AND FAN	87374615	1	1004049	4014486518436
17	ALTERNATOR DRIVE	84817626	1	1002579	4014486495560
18	DRUM DRIVE	84072772	1	1001237	4014486491913
18	DRUM DRIVE, ROTATION SPEED SLOW	84072815	1	1001952	4014486490572
19	STRAW SHAKER DRIVE	84817635	1	1000601	4014486469332
20	FAN VARI-DRIVE	84073979	1	1001421	4014486459289
21	ROTARY SEPARATOR DRIVE AND SHAFT	84073933	1	1000566	4014486468731
22		84075955	1	1003347	4014486486285
23		84076421	1	1001705	4014486486827
25	CHAFF SPREADER	84790356	1	1004472	4014486712148

### CX 720

1	BEATER DRIVE	84045256	1	1000638	4014486469950
3	UNLOADING AUGER	84061293	1	1001634	4014486485820
4	MAIN DRIVE	84057914	1	1003844	4014486490893
5	CHOPPER DRIVE	84075345	1	1001636	4014486485844
6	CHOPPER DRIVE	84075635	1	1001687	4014486486612
7	INTERMEDIATE SHAFT FOR CLEANING DRIVE, WITH SLOPE COMPENSATION	84057392	1	1003337	4014486484847
8	SHAKER SHOE DRIVE, FIXED SHOE, WITHOUT SLOPE COMPENSATION	84432785	1	1000680	4014486470543
9	STRAW WALKER DRIVE	84057482	1	1000400	4014486466638
10	SHAKER SHOE AND TAILINGS ELEVATOR DRIVE, WITH SLOPE COMPENSATION	84057874	1	1000699	4014486470826
11	TAILINGS ELEVATOR DRIVE, FIXED SHOE, WITHOUT SLOPE COMPENSATION	84435035	1	1001644	4014486485967
12	DRUM VARIATOR	84035748	1	1001316	4014486497892
13	SHAKER SHOE DRIVE - SELF-LEVELLING	84056913	2	1000265	4014486464207
14	DRUM DRIVE	84061615	1	1001884	4014486489408
15	HEADER, DRIVE 3HB	84061279	1	1001880	4014486489309
16	DRIVE, ROTARY SCREEN AND FAN, FOR HIGH SPEED ONLY	84057085	1	1000175	4014486462036
17	ROTOR AND VENTILATOR DRIVE	89835816	1	1002588	4014486495812
18	BLOW-OFF SYSTEM, AIR COMPRESSOR	84061465	1	1002586	4014486495775
19	DRIVE : ALTERNATOR, WATERPUMP AND AIR	84057710	1	1002690	4014486482959
20	GRAIN ELEVATOR , DRIVE	84073457	1	1000256	4014486464054
21	ROTARY SEPARATOR DRIVE AND SHAFT, -> C415	84057393	1	1001581	4014486484885



## NEW HOLLAND

21	ROTARY SEPARATOR DRIVE AND SHAFT, D416 ->	84457079	1	1001583	4014486484908
24	TAILINGS ELEVATORS, BOTTOM AUGER AND (RH)DRIVE	84058339	2	1000200	4014486462388
25	FAN VARI-DRIVE FOR FIXED SHOE ONLY	919739	1	1001136	4014486497205
25	FAN VARI-DRIVE FOR SELF-LEVELLING ONLY	84817627	1	1001135	4014486497199
22-23	DRIVE STRAW ELEVATOR 4HB	84334995	1	1004196	4014486652567

### CX 740

1	BEATER DRIVE	84045256	1	1000638	4014486469950
3	UNLOADING AUGER	84061293	1	1001634	4014486485820
4	MAIN DRIVE	84057914	1	1003844	4014486490893
5	CHOPPER DRIVE	84075345	1	1001636	4014486485844
6	CHOPPER DRIVE	84075635	1	1001687	4014486486612
7	INTERMEDIATE SHAFT FOR CLEANING DRIVE, WITH SLOPE COMPENSATION	84057392	1	1003337	4014486484847
8	SHAKER SHOE DRIVE, FIXED SHOE, WITHOUT SLOPE COMPENSATION	84432785	1	1000680	4014486470543
9	STRAW WALKER DRIVE	84057482	1	1000400	4014486466638
10	SHAKER SHOE AND TAILINGS ELEVATOR DRIVE, WITH SLOPE COMPENSATION	84057874	1	1000699	4014486470826
11	TAILINGS ELEVATOR DRIVE, FIXED SHOE, WITHOUT SLOPE COMPENSATION	84435035	1	1001644	4014486485967
12	DRUM VARIATOR	84035748	1	1001316	4014486497892
13	SHAKER SHOE DRIVE - SELF-LEVELLING	84056913	2	1000265	4014486464207
14	DRUM DRIVE	84061615	1	1001884	4014486489408
15	HEADER, DRIVE 3HB	84061279	1	1001880	4014486489309
16	DRIVE, ROTARY SCREEN AND FAN	84057085	1	1000175	4014486462036
17	ROTOR AND VENTILATOR DRIVE	89835816	1	1002588	4014486495812
18	BLOW-OFF SYSTEM, AIR COMPRESSOR	84061465	1	1002586	4014486495775
19	DRIVE : ALTERNATOR, WATERPUMP AND AIR	84057710	1	1002690	4014486482959
20	GRAIN ELEVATOR , DRIVE	84073457	1	1000256	4014486464054
21	ROTARY SEPARATOR DRIVE AND SHAFT, -> C415	84057393	1	1001581	4014486484885
21	ROTARY SEPARATOR DRIVE AND SHAFT, D416 ->	84457079	1	1001583	4014486484908
24	TAILINGS ELEVATORS, BOTTOM AUGER AND (RH)DRIVE	84058339	2	1000200	4014486462388
25	FAN VARI-DRIVE FOR FIXED SHOE ONLY	919739	1	1001136	4014486497205
25	FAN VARI-DRIVE FOR SELF-LEVELLING ONLY	84817627	1	1001135	4014486497199
22-23	DRIVE STRAW ELEVATOR 4HB	84334995	1	1004196	4014486652567

### CX 760

1	BEATER DRIVE	84045256	1	1000638	4014486469950
3	UNLOADING AUGER	84061293	1	1001634	4014486485820
4	MAIN DRIVE	84057914	1	1003844	4014486490893
5	CHOPPER DRIVE	84075345	1	1001636	4014486485844
6	CHOPPER DRIVE	84075635	1	1001687	4014486486612
7	INTERMEDIATE SHAFT FOR CLEANING DRIVE, WITH SLOPE COMPENSATION	84057392	1	1003337	4014486484847
8	SHAKER SHOE DRIVE, FIXED SHOE, WITHOUT SLOPE COMPENSATION	84432785	1	1000680	4014486470543
9	STRAW WALKER DRIVE	84057482	1	1000400	4014486466638
10	SHAKER SHOE AND TAILINGS ELEVATOR DRIVE, WITH SLOPE COMPENSATION	84057874	1	1000699	4014486470826
11	TAILINGS ELEVATOR DRIVE, FIXED SHOE, WITHOUT SLOPE COMPENSATION	84435035	1	1001644	4014486485967
12	DRUM VARIATOR	84035748	1	1001316	4014486497892
13	SHAKER SHOE DRIVE - SELF-LEVELLING	84056913	2	1000265	4014486464207
14	DRUM DRIVE	84061615	1	1001884	4014486489408
15	HEADER, DRIVE 3HB	84061279	1	1001880	4014486489309
16	DRIVE, ROTARY SCREEN AND FAN	84057085	1	1000175	4014486462036
17	ROTOR AND VENTILATOR DRIVE	89835816	1	1002588	4014486495812
18	BLOW-OFF SYSTEM, AIR COMPRESSOR	84061465	1	1002586	4014486495775
19	DRIVE : ALTERNATOR, WATERPUMP AND AIR	84057710	1	1002690	4014486482959
20	GRAIN ELEVATOR , DRIVE	84073457	1	1000256	4014486464054
21	ROTARY SEPARATOR DRIVE AND SHAFT, -> C415	84057393	1	1001581	4014486484885
21	ROTARY SEPARATOR DRIVE AND SHAFT, D416 ->	84457079	1	1001583	4014486484908



## NEW HOLLAND

24	TAILINGS ELEVATORS, BOTTOM AUGER AND (RH)DRIVE	84058339	2	1000200	4014486462388
25	FAN VARI-DRIVE FOR FIXED SHOE ONLY	919739	1	1001136	4014486497205
25	FAN VARI-DRIVE FOR SELF-LEVELLING ONLY	84817627	1	1001135	4014486497199
22-23	DRIVE STRAW ELEVATOR 4HB	84334995	1	1004196	4014486652567

### CX 780

1	BEATER DRIVE	84045256	1	1000638	4014486469950
3	UNLOADING AUGER	84061293	1	1001634	4014486485820
4	MAIN DRIVE	84057914	1	1003844	4014486490893
5	CHOPPER DRIVE	84075345	1	1001636	4014486485844
6	CHOPPER DRIVE	84075635	1	1001687	4014486486612
7	INTERMEDIATE SHAFT FOR CLEANING DRIVE, WITH SLOPE COMPENSATION	84057392	1	1003337	4014486484847
8	SHAKER SHOE DRIVE, FIXED SHOE, WITHOUT SLOPE COMPENSATION	84432785	1	1000680	4014486470543
9	STRAW WALKER DRIVE	84057482	1	1000400	4014486466638
10	SHAKER SHOE AND TAILINGS ELEVATOR DRIVE, WITH SLOPE COMPENSATION	84057874	1	1000699	4014486470826
11	TAILINGS ELEVATOR DRIVE, FIXED SHOE, WITHOUT SLOPE COMPENSATION	84435035	1	1001644	4014486485967
12	DRUM VARIATOR	84035748	1	1001316	4014486497892
13	SHAKER SHOE DRIVE - SELF-LEVELLING	84056913	2	1000265	4014486464207
14	DRUM DRIVE	84061615	1	1001884	4014486489408
15	HEADER, DRIVE 3HB	84061279	1	1001880	4014486489309
16	DRIVE, ROTARY SCREEN AND FAN	84057085	1	1000175	4014486462036
17	ROTOR AND VENTILATOR DRIVE	89835816	1	1002588	4014486495812
18	BLOW-OFF SYSTEM, AIR COMPRESSOR	84061465	1	1002586	4014486495775
19	DRIVE : ALTERNATOR, WATERPUMP AND AIR	84057710	1	1002690	4014486482959
20	GRAIN ELEVATOR , DRIVE	84073457	1	1000256	4014486464054
21	ROTARY SEPARATOR DRIVE AND SHAFT, -> C415	84057393	1	1001581	4014486484885
21	ROTARY SEPARATOR DRIVE AND SHAFT, D416 ->	84457079	1	1001583	4014486484908
24	TAILINGS ELEVATORS, BOTTOM AUGER AND (RH)DRIVE	84058339	2	1000200	4014486462388
25	FAN VARI-DRIVE FOR FIXED SHOE ONLY	919739	1	1001136	4014486497205
25	FAN VARI-DRIVE FOR SELF-LEVELLING ONLY	84817627	1	1001135	4014486497199
22-23	DRIVE STRAW ELEVATOR 4HB	84334995	1	1004196	4014486652567

### CX 8030

1	BEATER DRIVE	84045256	1	1000638	4014486469950
3	UNLOADING AUGER	84061293	1	1001634	4014486485820
4	MAIN DRIVE	84057914	1	1003844	4014486490893
5	CHOPPER DRIVE	84075345	1	1001636	4014486485844
6	CHOPPER DRIVE	87339998	1	1004042	4014486519464
7	INTERMEDIATE SHAFT FOR CLEANING DRIVE, WITH SLOPE COMPENSATION	84057392	1	1003337	4014486484847
8	SHAKER SHOE DRIVE, FIXED SHOE, WITHOUT SLOPE COMPENSATION	84432785	1	1000680	4014486470543
9	STRAW WALKER DRIVE	84057482	1	1000400	4014486466638
10	SHAKER SHOE AND TAILINGS ELEVATOR DRIVE, WITH SLOPE COMPENSATION	84057874	1	1000699	4014486470826
11	TAILINGS ELEVATOR DRIVE, FIXED SHOE, WITHOUT SLOPE COMPENSATION	84435035	1	1001644	4014486485967
12	DRUM VARIATOR	84035748	1	1001316	4014486497892
13	SHAKER SHOE DRIVE - SELF-LEVELLING	84056913	2	1000265	4014486464207
14	DRUM DRIVE WITHOUT REDUCTOR	84061615	1	1001884	4014486489408
15	HEADER, DRIVE 3HB	84061279	1	1001880	4014486489309
16	DRIVE, ROTARY SCREEN AND FAN	84057085	1	1000175	4014486462036
17	ROTOR AND VENTILATOR DRIVE	89835816	1	1002588	4014486495812
18	DRIVE, ROTARY SCREEN AND FAN	84061465	1	1002586	4014486495775
19	DRIVE : ALTERNATOR, WATERPUMP AND AIR	84057710	1	1002690	4014486482959
20	GRAIN ELEVATOR , DRIVE	84073457	1	1000256	4014486464054
21	ROTARY SEPARATOR DRIVE AND SHAFT	84457079	1	1001583	4014486484908
24	TAILINGS ELEVATORS, BOTTOM AUGER AND (RH)	84058339	2	1000200	4014486462388
25	FAN VARI-DRIVE FOR FIXED SHOE ONLY	919739	1	1001136	4014486497205

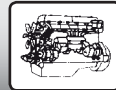

## NEW HOLLAND

25	FAN VARI-DRIVE FOR SELF-LEVELLING ONLY	84817627	1	1001135	4014486497199
22-23	DRIVE STRAW ELEVATOR 4HB	84334995	1	1004196	4014486652567

### CX 8040

1	BEATER DRIVE	84045256	1	1000638	4014486469950
3	UNLOADING AUGER	84061293	1	1001634	4014486485820
4	MAIN DRIVE	84057914	1	1003844	4014486490893
5	CHOPPER DRIVE	84075345	1	1001636	4014486485844
6	CHOPPER DRIVE	87339998	1	1004042	4014486519464
7	INTERMEDIATE SHAFT FOR CLEANING DRIVE, WITH SLOPE COMPENSATION	84057392	1	1003337	4014486484847
8	SHAKER SHOE DRIVE, FIXED SHOE, WITHOUT SLOPE COMPENSATION	84432785	1	1000680	4014486470543
9	STRAW WALKER DRIVE	84057482	1	1000400	4014486466638
10	SHAKER SHOE AND TAILINGS ELEVATOR DRIVE, WITH SLOPE COMPENSATION	84057874	1	1000699	4014486470826
11	TAILINGS ELEVATOR DRIVE, FIXED SHOE, WITHOUT SLOPE COMPENSATION	84435035	1	1001644	4014486485967
12	DRUM VARIATOR	84035748	1	1001316	4014486497892
13	SHAKER SHOE DRIVE - SELF-LEVELLING	84056913	2	1000265	4014486464207
14	DRUM DRIVE WITHOUT REDUCTOR	84061615	1	1001884	4014486489408
15	HEADER, DRIVE 3HB	84061279	1	1001880	4014486489309
16	DRIVE, ROTARY SCREEN AND FAN	84057085	1	1000175	4014486462036
17	ROTOR AND VENTILATOR DRIVE	89835816	1	1002588	4014486495812
18	DRIVE, ROTARY SCREEN AND FAN	84061465	1	1002586	4014486495775
19	DRIVE : ALTERNATOR, WATERPUMP AND AIR	84057710	1	1002690	4014486482959
20	GRAIN ELEVATOR , DRIVE	84073457	1	1000256	4014486464054
21	ROTARY SEPARATOR DRIVE AND SHAFT	84457079	1	1001583	4014486484908
24	TAILINGS ELEVATORS, BOTTOM AUGER AND (RH)	84058339	2	1000200	4014486462388
25	FAN VARI-DRIVE FOR FIXED SHOE ONLY	919739	1	1001136	4014486497205
25	FAN VARI-DRIVE FOR SELF-LEVELLING ONLY	84817627	1	1001135	4014486497199
22-23	DRIVE STRAW ELEVATOR 4HB	84334995	1	1004196	4014486652567

### CX 8050

1	BEATER DRIVE	84045256	1	1000638	4014486469950
3	UNLOADING AUGER	84061293	1	1001634	4014486485820
4	MAIN DRIVE	84057914	1	1003844	4014486490893
5	CHOPPER DRIVE	84075345	1	1001636	4014486485844
6	CHOPPER DRIVE	87339998	1	1004042	4014486519464
7	INTERMEDIATE SHAFT FOR CLEANING DRIVE, WITH SLOPE COMPENSATION	84057392	1	1003337	4014486484847
8	SHAKER SHOE DRIVE, FIXED SHOE, WITHOUT SLOPE COMPENSATION	84432785	1	1000680	4014486470543
9	STRAW WALKER DRIVE	84057482	1	1000400	4014486466638
10	SHAKER SHOE AND TAILINGS ELEVATOR DRIVE, WITH SLOPE COMPENSATION	84057874	1	1000699	4014486470826
11	TAILINGS ELEVATOR DRIVE, FIXED SHOE, WITHOUT SLOPE COMPENSATION	84435035	1	1001644	4014486485967
12	DRUM VARIATOR	84035748	1	1001316	4014486497892
13	SHAKER SHOE DRIVE - SELF-LEVELLING	84056913	2	1000265	4014486464207
14	DRUM DRIVE WITHOUT REDUCTOR	84061615	1	1001884	4014486489408
15	HEADER, DRIVE 3HB	84061279	1	1001880	4014486489309
16	DRIVE, ROTARY SCREEN AND FAN	84057085	1	1000175	4014486462036
17	ROTOR AND VENTILATOR DRIVE	89835816	1	1002588	4014486495812
18	DRIVE, ROTARY SCREEN AND FAN	84061465	1	1002586	4014486495775
19	DRIVE : ALTERNATOR, WATERPUMP AND AIR	84057710	1	1002690	4014486482959
20	GRAIN ELEVATOR , DRIVE	84073457	1	1000256	4014486464054
21	ROTARY SEPARATOR DRIVE AND SHAFT	84457079	1	1001583	4014486484908
24	TAILINGS ELEVATORS, BOTTOM AUGER AND (RH)	84058339	2	1000200	4014486462388
25	FAN VARI-DRIVE FOR FIXED SHOE ONLY	919739	1	1001136	4014486497205
25	FAN VARI-DRIVE FOR SELF-LEVELLING ONLY	84817627	1	1001135	4014486497199
22-23	DRIVE STRAW ELEVATOR 4HB	84334995	1	1004196	4014486652567

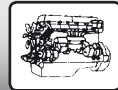

## NEW HOLLAND

### CX 8060

1	BEATER DRIVE	84045256	1	1000638	4014486469950
3	UNLOADING AUGER	84061293	1	1001634	4014486485820
4	MAIN DRIVE	84057914	1	1003844	4014486490893
5	CHOPPER DRIVE	84075345	1	1001636	4014486485844
6	CHOPPER DRIVE	87339998	1	1004042	4014486519464
7	INTERMEDIATE SHAFT FOR CLEANING DRIVE, WITH SLOPE COMPENSATION	84057392	1	1003337	4014486484847
8	SHAKER SHOE DRIVE, FIXED SHOE, WITHOUT SLOPE COMPENSATION	84432785	1	1000680	4014486470543
9	STRAW WALKER DRIVE	84057482	1	1000400	4014486466638
10	SHAKER SHOE AND TAILINGS ELEVATOR DRIVE, WITH SLOPE COMPENSATION	84057874	1	1000699	4014486470826
11	TAILINGS ELEVATOR DRIVE, FIXED SHOE, WITHOUT SLOPE COMPENSATION	84435035	1	1001644	4014486485967
12	DRUM VARIATOR	84035748	1	1001316	4014486497892
13	SHAKER SHOE DRIVE - SELF-LEVELLING	84056913	2	1000265	4014486464207
14	DRUM DRIVE WITHOUT REDUCTOR	84061615	1	1001884	4014486489408
15	HEADER, DRIVE 3HB	84061279	1	1001880	4014486489309
16	DRIVE, ROTARY SCREEN AND FAN	84057085	1	1000175	4014486462036
17	ROTOR AND VENTILATOR DRIVE	89835816	1	1002588	4014486495812
18	DRIVE, ROTARY SCREEN AND FAN	84061465	1	1002586	4014486495775
19	DRIVE : ALTERNATOR, WATERPUMP AND AIR	84057710	1	1002690	4014486482959
20	GRAIN ELEVATOR , DRIVE	84073457	1	1000256	4014486464054
21	ROTARY SEPARATOR DRIVE AND SHAFT	84457079	1	1001583	4014486484908
24	TAILINGS ELEVATORS, BOTTOM AUGER AND (RH)	84058339	2	1000200	4014486462388
25	FAN VARI-DRIVE FOR FIXED SHOE ONLY	919739	1	1001136	4014486497205
25	FAN VARI-DRIVE FOR SELF-LEVELLING ONLY	84817627	1	1001135	4014486497199
22-23	DRIVE STRAW ELEVATOR 4HB	84334995	1	1004196	4014486652567

### CX 8080

1	BEATER DRIVE	84045256	1	1000638	4014486469950
3	UNLOADING AUGER	84061293	1	1001634	4014486485820
4	MAIN DRIVE	84057914	1	1003844	4014486490893
5	CHOPPER DRIVE	84075345	1	1001636	4014486485844
6	CHOPPER DRIVE	87339998	1	1004042	4014486519464
7	INTERMEDIATE SHAFT FOR CLEANING DRIVE, WITH SLOPE COMPENSATION	84057392	1	1003337	4014486484847
8	SHAKER SHOE DRIVE, FIXED SHOE, WITHOUT SLOPE COMPENSATION	84432785	1	1000680	4014486470543
9	STRAW WALKER DRIVE	84057482	1	1000400	4014486466638
10	SHAKER SHOE AND TAILINGS ELEVATOR DRIVE, WITH SLOPE COMPENSATION	84057874	1	1000699	4014486470826
11	TAILINGS ELEVATOR DRIVE, FIXED SHOE, WITHOUT SLOPE COMPENSATION	84435035	1	1001644	4014486485967
12	DRUM VARIATOR	84035748	1	1001316	4014486497892
13	SHAKER SHOE DRIVE - SELF-LEVELLING	84056913	2	1000265	4014486464207
14	DRUM DRIVE WITHOUT REDUCTOR	84061615	1	1001884	4014486489408
15	HEADER, DRIVE 3HB	84061279	1	1001880	4014486489309
16	DRIVE, ROTARY SCREEN AND FAN	84057085	1	1000175	4014486462036
17	ROTOR AND VENTILATOR DRIVE	89835816	1	1002588	4014486495812
18	DRIVE, ROTARY SCREEN AND FAN	84061465	1	1002586	4014486495775
19	DRIVE : ALTERNATOR, WATERPUMP AND AIR	84057710	1	1002690	4014486482959
20	GRAIN ELEVATOR , DRIVE	84073457	1	1000256	4014486464054
21	ROTARY SEPARATOR DRIVE AND SHAFT	84457079	1	1001583	4014486484908
24	TAILINGS ELEVATORS, BOTTOM AUGER AND (RH)	84058339	2	1000200	4014486462388
25	FAN VARI-DRIVE FOR FIXED SHOE ONLY	919739	1	1001136	4014486497205
25	FAN VARI-DRIVE FOR SELF-LEVELLING ONLY	84817627	1	1001135	4014486497199
22-23	DRIVE STRAW ELEVATOR 4HB	84334995	1	1004196	4014486652567

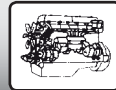

## NEW HOLLAND

### CX 8090

1	BEATER DRIVE	84045256	1	1000638	4014486469950
3	UNLOADING AUGER	84061293	1	1001634	4014486485820
4	MAIN DRIVE	84057914	1	1003844	4014486490893
5	CHOPPER DRIVE	84075345	1	1001636	4014486485844
6	CHOPPER DRIVE	87339998	1	1004042	4014486519464
7	INTERMEDIATE SHAFT FOR CLEANING DRIVE, WITH SLOPE COMPENSATION	84057392	1	1003337	4014486484847
8	SHAKER SHOE DRIVE, FIXED SHOE, WITHOUT SLOPE COMPENSATION	84432785	1	1000680	4014486470543
9	STRAW WALKER DRIVE	84057482	1	1000400	4014486466638
10	SHAKER SHOE AND TAILINGS ELEVATOR DRIVE, WITH SLOPE COMPENSATION	84057874	1	1000699	4014486470826
11	TAILINGS ELEVATOR DRIVE, FIXED SHOE, WITHOUT SLOPE COMPENSATION	84435035	1	1001644	4014486485967
12	DRUM VARIATOR FOR CX8030, CX8040, CX8050, CX8060, CX8070, CX8080 ONLY	84035748	1	1001316	4014486497892
13	SHAKER SHOE DRIVE - SELF-LEVELLING	84056913	2	1000265	4014486464207
14	DRUM DRIVE WITHOUT REDUCTOR	84061615	1	1001884	4014486489408
15	HEADER, DRIVE 3HB	84061279	1	1001880	4014486489309
16	DRIVE, ROTARY SCREEN AND FAN	84057085	1	1000175	4014486462036
17	DRIVE, ROTARY SCREEN AND FAN	84459056	2	1004161	4014486523393
17	ROTOR AND VENTILATOR DRIVE	89835816	1	1002588	4014486495812
18	DRIVE, ROTARY SCREEN AND FAN	84061465	1	1002586	4014486495775
19	DRIVE : ALTERNATOR, WATERPUMP AND AIR	84057710	1	1002690	4014486482959
20	GRAIN ELEVATOR , DRIVE	84073457	1	1000256	4014486464054
21	ROTARY SEPARATOR DRIVE AND SHAFT	84457079	1	1001583	4014486484908
24	TAILINGS ELEVATORS, BOTTOM AUGER AND (RH)	84058339	2	1000200	4014486462388
25	FAN VARI-DRIVE FOR FIXED SHOE ONLY	919739	1	1001136	4014486497205
25	FAN VARI-DRIVE FOR SELF-LEVELLING ONLY	84817627	1	1001135	4014486497199
22-23	DRIVE STRAW ELEVATOR 4HB	84334995	1	1004196	4014486652567

### CX 820

1	BEATER DRIVE	84045256	1	1000638	4014486469950
3	UNLOADING AUGER	84061293	1	1001634	4014486485820
4	MAIN DRIVE	84057914	1	1003844	4014486490893
5	CHOPPER DRIVE	84075345	1	1001636	4014486485844
6	CHOPPER DRIVE	84075635	1	1001687	4014486486612
7	INTERMEDIATE SHAFT FOR CLEANING DRIVE, WITH SLOPE COMPENSATION	84057392	1	1003337	4014486484847
8	SHAKER SHOE DRIVE, FIXED SHOE, WITHOUT SLOPE COMPENSATION	84432785	1	1000680	4014486470543
9	STRAW WALKER DRIVE	84057482	1	1000400	4014486466638
10	SHAKER SHOE AND TAILINGS ELEVATOR DRIVE, WITH SLOPE COMPENSATION	84057874	1	1000699	4014486470826
11	TAILINGS ELEVATOR DRIVE, FIXED SHOE, WITHOUT SLOPE COMPENSATION	84435035	1	1001644	4014486485967
12	DRUM VARIATOR	84035748	1	1001316	4014486497892
13	SHAKER SHOE DRIVE - SELF-LEVELLING	84056913	2	1000265	4014486464207
14	DRUM DRIVE	84061615	1	1001884	4014486489408
15	HEADER, DRIVE 3HB	84061279	1	1001880	4014486489309
16	DRIVE, ROTARY SCREEN AND FAN	84057085	1	1000175	4014486462036
17	ROTOR AND VENTILATOR DRIVE	89835816	1	1002588	4014486495812
18	BLOW-OFF SYSTEM, AIR COMPRESSOR	84061465	1	1002586	4014486495775
19	DRIVE : ALTERNATOR, WATERPUMP AND AIR	84057710	1	1002690	4014486482959
20	GRAIN ELEVATOR , DRIVE	84073457	1	1000256	4014486464054
21	ROTARY SEPARATOR DRIVE AND SHAFT, -> C415	84057393	1	1001581	4014486484885
21	ROTARY SEPARATOR DRIVE AND SHAFT, D416 ->	84457079	1	1001583	4014486484908
24	TAILINGS ELEVATORS, BOTTOM AUGER AND (RH)DRIVE	84058339	2	1000200	4014486462388
25	FAN VARI-DRIVE FOR FIXED SHOE ONLY	919739	1	1001136	4014486497205
25	FAN VARI-DRIVE FOR SELF-LEVELLING ONLY	84817627	1	1001135	4014486497199
22-23	DRIVE STRAW ELEVATOR 4HB	84334995	1	1004196	4014486652567



## NEW HOLLAND

### CX 840

2	GRASS SEED EQUIPMENT - ACCESSORIES FOR SELF LEVELLING ONLY	84023277	1	1001132	4014486497168
2	GRASS SEED EQUIPMENT - ACCESSORIES FOR FIXED SHOE ONLY	84023278	1	1001133	4014486497175
3	SHAKER SHOE DRIVE - SELF-LEVELLING	84056913	2	1000265	4014486464207
4	INTERMEDIATE SHAFT - CLEANING DRIVE	84057392	1	1003337	4014486484847
5	STRAW WALKER DRIVE	84057482	1	1000400	4014486466638
6	SHAKER SHOE AND TAILINGS ELEVATOR DRIVE - SELF LEVELLING	84057874	1	1000699	4014486470826
7	TAILINGS ELEVATORS - BOTTOM AUGER AND (RIGHT HAND) DRIVE	84058339	2	1000200	4014486462388
8	SHAKER SHOE DRIVE - FIXED SHOE	84432785	1	1000680	4014486470543
9	TAILINGS ELEVATOR DRIVE - FIXED SHOE	84435035	1	1001644	4014486485967
10	MAIN FAN VARIABLE SPEED DRIVE FOR FIXED SHOE ONLY	919739	1	1001136	4014486497205
10	MAIN FAN VARIABLE SPEED DRIVE FOR SELF LEVELLING ONLY	9502654	1	1001135	4014486497199
11	ROTARY SCREEN AND FAN	84057085	1	1000175	4014486462036
12	ALTERNATOR, WATERPUMP AND AIR COMPRESSOR	84057710	1	1002690	4014486482959
13	MAIN DRIVE	84057914	1	1003844	4014486490893
14	ROTARY SCREEN AND FAN	84061465	1	1002586	4014486495775
15	AIR COMPRESSOR - BLOW-OFF SYSTEM	84061465	1	1002586	4014486495775
17	ROTARY SCREEN AND FAN	9835816	1	1002588	4014486495812
18	HEADER DRIVE	84061279	1	1001880	4014486489309
19	STRAW ELEVATOR DRIVE	84334995	1	1004196	4014486652567
20	STRAW ELEVATOR DRIVE	84434260	1	1001714	4014486486940
21	STRAW ELEVATOR DRIVE	84434295	1	1001645	4014486485974
22	DRUM DRIVE VARIABLE SPEED	84035748	1	1001316	4014486497892
23	BEATER DRIVE	84045256	1	1000638	4014486469950
24	ROTARY SEPARATOR DRIVE AND SHAFT	84057393	1	1001581	4014486484885
25	DRUM DRIVE WITH REDUCTOR	84061615	1	1001884	4014486489408
26	DRUM DRIVE WITHOUT REDUCTOR	84061615	1	1001884	4014486489408
27	ROTARY SEPARATOR DRIVE AND SHAFT	84457079	1	1001583	4014486484908
28	UNLOADING AUGER DRIVE	84061293	1	1001634	4014486485820
29	ELEVATOR DRIVE GRAIN	84073457	1	1000256	4014486464054
1A	CHOPPER DRIVE	84075345	1	1001636	4014486485844
1B	CHOPPER DRIVE	84075635	1	1001687	4014486486612

### CX 860

2	GRASS SEED EQUIPMENT - ACCESSORIES FOR SELF LEVELLING ONLY	84023277	1	1001132	4014486497168
2	GRASS SEED EQUIPMENT - ACCESSORIES FOR FIXED SHOE ONLY	84023278	1	1001133	4014486497175
3	SHAKER SHOE DRIVE - SELF-LEVELLING	84056913	2	1000265	4014486464207
4	INTERMEDIATE SHAFT - CLEANING DRIVE	84057392	1	1003337	4014486484847
5	STRAW WALKER DRIVE	84057482	1	1000400	4014486466638
6	SHAKER SHOE AND TAILINGS ELEVATOR DRIVE - SELF LEVELLING	84057874	1	1000699	4014486470826
7	TAILINGS ELEVATORS - BOTTOM AUGER AND (RIGHT HAND) DRIVE	84058339	2	1000200	4014486462388
8	SHAKER SHOE DRIVE - FIXED SHOE	84432785	1	1000680	4014486470543
9	TAILINGS ELEVATOR DRIVE - FIXED SHOE	84435035	1	1001644	4014486485967
10	MAIN FAN VARIABLE SPEED DRIVE FOR FIXED SHOE ONLY	919739	1	1001136	4014486497205
10	MAIN FAN VARIABLE SPEED DRIVE FOR SELF LEVELLING ONLY	9502654	1	1001135	4014486497199
11	ROTARY SCREEN AND FAN	84057085	1	1000175	4014486462036
12	ALTERNATOR, WATERPUMP AND AIR COMPRESSOR	84057710	1	1002690	4014486482959
13	MAIN DRIVE	84057914	1	1003844	4014486490893
14	ROTARY SCREEN AND FAN	84061465	1	1002586	4014486495775
15	AIR COMPRESSOR - BLOW-OFF SYSTEM	84061465	1	1002586	4014486495775
18	HEADER DRIVE	84061279	1	1001880	4014486489309
19	STRAW ELEVATOR DRIVE	84334995	1	1004196	4014486652567
20	STRAW ELEVATOR DRIVE	84434260	1	1001714	4014486486940
21	STRAW ELEVATOR DRIVE	84434295	1	1001645	4014486485974



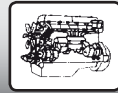

## NEW HOLLAND

22	DRUM DRIVE VARIABLE SPEED	84035748	1	1001316	4014486497892
23	BEATER DRIVE	84045256	1	1000638	4014486469950
24	ROTARY SEPARATOR DRIVE AND SHAFT	84057393	1	1001581	4014486484885
25	DRUM DRIVE WITH REDUCTOR	84061615	1	1001884	4014486489408
26	DRUM DRIVE WITHOUT REDUCTOR	84061615	1	1001884	4014486489408
27	ROTARY SEPARATOR DRIVE AND SHAFT	84457079	1	1001583	4014486484908
28	UNLOADING AUGER DRIVE	84061293	1	1001634	4014486485820
29	ELEVATOR DRIVE GRAIN	84073457	1	1000256	4014486464054
1A	CHOPPER DRIVE	84075345	1	1001636	4014486485844
1B	CHOPPER DRIVE	84075635	1	1001687	4014486486612

### CX 880

2	GRASS SEED EQUIPMENT - ACCESSORIES FOR SELF LEVELLING ONLY	84023277	1	1001132	4014486497168
2	GRASS SEED EQUIPMENT - ACCESSORIES FOR FIXED SHOE ONLY	84023278	1	1001133	4014486497175
3	SHAKER SHOE DRIVE - SELF-LEVELLING	84056913	2	1000265	4014486464207
4	INTERMEDIATE SHAFT - CLEANING DRIVE	84057392	1	1003337	4014486484847
5	STRAW WALKER DRIVE	84057482	1	1000400	4014486466638
6	SHAKER SHOE AND TAILINGS ELEVATOR DRIVE - SELF LEVELLING	84057874	1	1000699	4014486470826
7	TAILINGS ELEVATORS - BOTTOM AUGER AND (RIGHT HAND) DRIVE	84058339	2	1000200	4014486462388
8	SHAKER SHOE DRIVE - FIXED SHOE	84432785	1	1000680	4014486470543
9	TAILINGS ELEVATOR DRIVE - FIXED SHOE	84435035	1	1001644	4014486485967
10	MAIN FAN VARIABLE SPEED DRIVE FOR FIXED SHOE ONLY	919739	1	1001136	4014486497205
10	MAIN FAN VARIABLE SPEED DRIVE FOR SELF LEVELLING ONLY	9502654	1	1001135	4014486497199
11	ROTARY SCREEN AND FAN	84057085	1	1000175	4014486462036
12	ALTERNATOR, WATERPUMP AND AIR COMPRESSOR	84057710	1	1002690	4014486482959
13	MAIN DRIVE	84057914	1	1003844	4014486490893
14	ROTARY SCREEN AND FAN	84061465	1	1002586	4014486495775
15	AIR COMPRESSOR - BLOW-OFF SYSTEM	84061465	1	1002586	4014486495775
18	HEADER DRIVE	84061279	1	1001880	4014486489309
19	STRAW ELEVATOR DRIVE	84334995	1	1004196	4014486652567
20	STRAW ELEVATOR DRIVE	84434260	1	1001714	4014486486940
21	STRAW ELEVATOR DRIVE	84434295	1	1001645	4014486485974
22	DRUM DRIVE VARIABLE SPEED	84035748	1	1001316	4014486497892
23	BEATER DRIVE	84045256	1	1000638	4014486469950
24	ROTARY SEPARATOR DRIVE AND SHAFT	84057393	1	1001581	4014486484885
25	DRUM DRIVE WITH REDUCTOR	84061615	1	1001884	4014486489408
26	DRUM DRIVE WITHOUT REDUCTOR	84061615	1	1001884	4014486489408
27	ROTARY SEPARATOR DRIVE AND SHAFT	84457079	1	1001583	4014486484908
28	UNLOADING AUGER DRIVE	84061293	1	1001634	4014486485820
29	ELEVATOR DRIVE GRAIN	84073457	1	1000256	4014486464054
1A	CHOPPER DRIVE	84075345	1	1001636	4014486485844
1B	CHOPPER DRIVE	84075635	1	1001687	4014486486612

### FX 300

1	MAIN DRIVE	84017742	2	1001167	4014486491784
2	DRIVE	84026761	4	1002746	4014486461862
3	FAN DRIVE	84012975	2	1002087	4014486519129
4	ALTERNATOR DRIVE	84022807	1	1001132	4014486497168
5	COMPRESSOR DRIVE	80747177	1	1002582	4014486495638
5	COMPRESSOR DRIVE	89835815	1	1002588	4014486495812

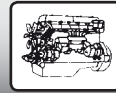
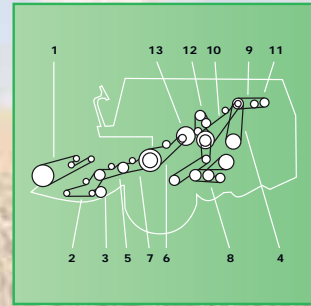
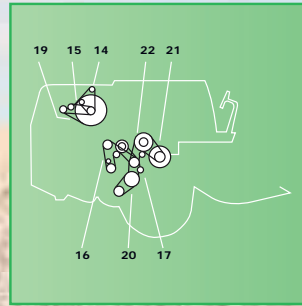
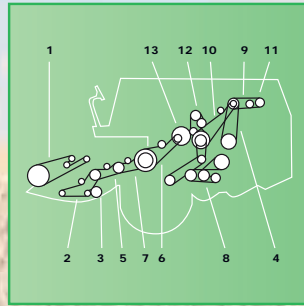
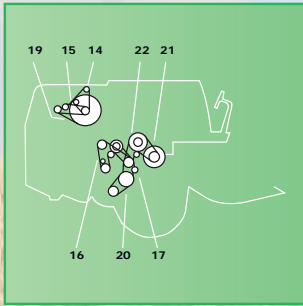

## NEW HOLLAND

### FX 375

1	MAIN DRIVE	84017742	2	1001167	4014486491784
2	DRIVE	84026761	4	1002746	4014486461862
3	FAN DRIVE	84012975	2	1002087	4014486519129
4	ALTERNATOR DRIVE	84022807	1	1001132	4014486497168
5	COMPRESSOR DRIVE	80747177	1	1002582	4014486495638
5	COMPRESSOR DRIVE	89835815	1	1002588	4014486495812

### FX 450

1	MAIN DRIVE	84017742	2	1001167	4014486491784
2	DRIVE	84026761	4	1002746	4014486461862
3	FAN DRIVE	84012975	2	1002087	4014486519129
4	ALTERNATOR DRIVE	84022807	1	1001132	4014486497168
5	COMPRESSOR DRIVE	80747177	1	1002582	4014486495638
5	COMPRESSOR DRIVE	89835815	1	1002588	4014486495812

### M 103

1	THRESHING DRUM VARIATOR DRIVE	80230078	1	1001509	4014486460254
8	REEL DRIVE INTERMEDIATE SHAFT - (LOWER)	80230057	1	1000603	4014486469370
10	REEL DRIVE	80230060	1	1003534	4014486470536
11	HYDRAULIC PUMP DRIVE	80230043	1	1003400	4014486462906
18	POWER STEERING	80230043	1	1003400	4014486462906
26	AUGER DRIVE GRAIN TANK	80230045	1	1001568	4014486484717

### M 122

1	HYDRAULIC PUMP DRIVE	80230043	1	1003400	4014486462906
2	TAILINGS ELEVATOR	80230046	1	1004468	4014486712124
3	STRAW ELEVATOR DRIVE	80230059	1	1000654	4014486470178
4	GRAIN TANK UNLOADING	80230061	1	1000717	4014486471076
5	REEL DRIVE	80230061	1	1000717	4014486471076
11	ELEVATOR DRIVE	80230046	1	1004468	4014486712124
12	CYLINDER	80230078	1	1001509	4014486460254
13	UNLOADING SYSTEM	80326298	1	1003489	4014486468427
14	FAN DRIVE	80330204	1	1000243	4014486463613
15	DEUTZ ENGINE	80327040	1	1002267	4014486478358

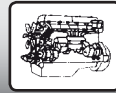
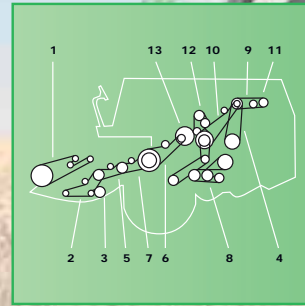
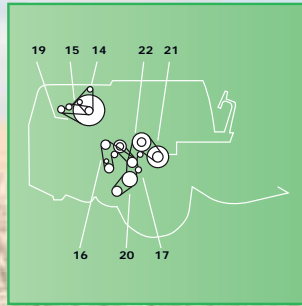
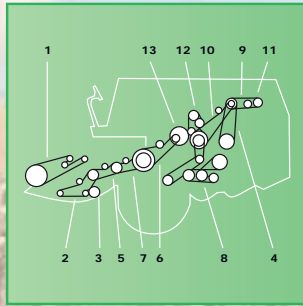
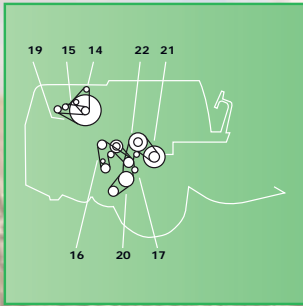

## NEW HOLLAND

### M 133

1	HYDRAULIC PUMP DRIVE	80230043	1	1003400	4014486462906
2	REEL DRIVE ECCENTRIC	80230060	1	1003534	4014486470536
3	REEL DRIVE	80230061	1	1000717	4014486471076
4	STRAW ELEVATOR DRIVE	80230073	1	1000904	4014486473506
11	FAN DRIVE VARIABLE SPEED	80230056	1	1003232	4014486518658
12	TAILINGS ELEVATOR DRIVE	80230057	1	1000603	4014486469370
12	ELEVATOR DRIVE GRAIN	80230059	1	1000654	4014486470178
13	ELEVATOR DRIVE UNIT	80230059	1	1000654	4014486470178
14	CYLINDER	80230078	1	1001509	4014486460254
16	DISCHARGE AUGER SHAFT	80230103	1	1000881	4014486473216
17	STRAW WALKER DRIVE	80230108	1	1003452	4014486465617
18	FAN DRIVE	80336386	1	1000027	4014486483482
19	ALTERNATOR DRIVE	80336426	1	1000020	4014486483390

### M 135

1	HYDRAULIC PUMP DRIVE	80230043	1	1003400	4014486462906
2	REEL DRIVE ECCENTRIC	80230060	1	1003534	4014486470536
3	REEL DRIVE	80230061	1	1000717	4014486471076
4	STRAW ELEVATOR DRIVE	80230073	1	1000904	4014486473506
11	FAN DRIVE VARIABLE SPEED	80230056	1	1003232	4014486518658
12	TAILINGS ELEVATOR DRIVE	80230057	1	1000603	4014486469370
12	ELEVATOR DRIVE GRAIN	80230059	1	1000654	4014486470178
13	ELEVATOR DRIVE UNIT	80230059	1	1000654	4014486470178
14	CYLINDER	80230078	1	1001509	4014486460254
16	DISCHARGE AUGER SHAFT	80230103	1	1000881	4014486473216
17	STRAW WALKER DRIVE	80230108	1	1003452	4014486465617
18	FAN DRIVE	80336386	1	1000027	4014486483482
19	ALTERNATOR DRIVE	80336426	1	1000020	4014486483390

### M 140

1	HYDRAULIC PUMP DRIVE	80230043	1	1003400	4014486462906
2	REEL DRIVE ECCENTRIC	80230060	1	1003534	4014486470536
3	REEL DRIVE	80230061	1	1000717	4014486471076
4	STRAW ELEVATOR DRIVE	80230073	1	1000904	4014486473506
11	FAN DRIVE VARIABLE SPEED	80230056	1	1003232	4014486518658
12	TAILINGS ELEVATOR DRIVE	80230057	1	1000603	4014486469370
12	ELEVATOR DRIVE GRAIN	80230059	1	1000654	4014486470178
13	ELEVATOR DRIVE UNIT	80230059	1	1000654	4014486470178
14	CYLINDER	80230078	1	1001509	4014486460254
16	DISCHARGE AUGER SHAFT	80230103	1	1000881	4014486473216
17	STRAW WALKER DRIVE	80230108	1	1003452	4014486465617
18	FAN DRIVE	80336386	1	1000027	4014486483482
19	ALTERNATOR DRIVE	80336426	1	1000020	4014486483390

### M 80

1	HYDRAULIC PUMP DRIVE	80230043	1	1003400	4014486462906
2	TAILINGS ELEVATOR	80230046	1	1004468	4014486712124
5	STRAW ELEVATOR DRIVE	80230059	1	1000654	4014486470178
6	REEL DRIVE	80230060	1	1003534	4014486470536
7	STICKLE KNIFE DRIVE	80230060	1	1003534	4014486470536
8	GRAIN TANK UNLOADING	80230061	1	1000717	4014486471076
18	ELEVATOR DRIVE	80230046	1	1004468	4014486712124
20	CYLINDER	80230078	1	1001509	4014486460254

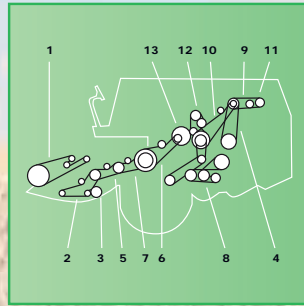
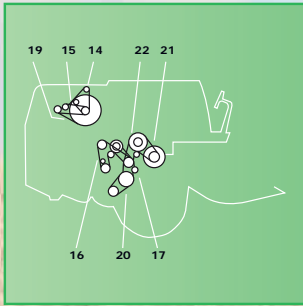

# NEW HOLLAND

## M 89

1	HYDRAULIC PUMP DRIVE	80230043	1	1003400	4014486462906
3	STRAW ELEVATOR DRIVE	80230059	1	1000654	4014486470178
4	REEL DRIVE	80230060	1	1003534	4014486470536
5	STICKLE KNIFE DRIVE	80230060	1	1003534	4014486470536
6	GRAIN TANK UNLOADING	80230061	1	1000717	4014486471076
10	TAILINGS ELEVATOR	80230046	1	1004468	4014486712124
14	ELEVATOR DRIVE	80230046	1	1004468	4014486712124
16	CYLINDER	80230078	1	1001509	4014486460254

## TC 5040

3	DRIVE, ROTARY SCREEN AND FAN	84989965	1	1000169	4014486461954
4	AIR CONDITIONING FAN DRIVE	9818704	1	1000074	4014486483949
4	INTERMEDIATE SHAFT DRIVE	87535206	1	1003727	4014486495164
4	AIR CONDITIONING FAN DRIVE	89818704	1	1000074	4014486483949
7	UNLOADING AUGER DRIVE	84448591	1	1000657	4014486470215
8	HEADER DRIVE ENGAGING IDLER 3HB ONLY	89817374	1	1001876	4014486470833
9	UPPER GROUND SPEED	80356024	1	1001489	4014486459999
10	VARIATOR DRIVE	9850782	1	1001491	4014486460018
10	VARIATOR DRIVE	89850782	1	1001491	4014486460018
11	DRIVE GROUP FOR GRAIN AND TAILINGS ELEVATOR	80422731	1	1000696	4014486470772
12	ECCENTRIC SHAFT DRIVE	80387469	1	1000700	4014486470833
15	DRUM VARI-DRIVE CONTROL	336784	1	1001506	4014486460216
16	FAN VARI-DRIVE	9515075	1	1001428	4014486459364
16	FAN VARI-DRIVE	89515075	1	1001428	4014486459364
17	FAN VARI-DRIVE	9515076	1	1001416	4014486459234
17	FAN VARI-DRIVE	89515076	1	1001416	4014486459234
18	STRAW WALKER SHAFT	80431784	1	1000328	4014486465587
20	ROTARY SEPARATOR DRIVE	89837412	1	1000573	4014486468816
13-14	2HC DRIVE BESIDE STRAW ELEVATOR	84971217	1	1001782	4014486520385

## TC 5050

3	DRIVE, ROTARY SCREEN AND FAN	84989965	1	1000169	4014486461954
4	AIR CONDITIONING FAN DRIVE	9818704	1	1000074	4014486483949
4	INTERMEDIATE SHAFT DRIVE	87535206	1	1003727	4014486495164
4	AIR CONDITIONING FAN DRIVE	89818704	1	1000074	4014486483949
7	UNLOADING AUGER DRIVE	84448591	1	1000657	4014486470215
8	HEADER DRIVE ENGAGING IDLER 3HB ONLY	89817374	1	1001876	4014486489231
11	DRIVE GROUP FOR GRAIN AND TAILINGS ELEVATOR	80422731	1	1000696	4014486470772
12	ECCENTRIC SHAFT DRIVE	80387469	1	1000700	4014486470833
15	DRUM VARI-DRIVE CONTROL	336784	1	1001506	4014486460216
16	FAN VARI-DRIVE	9515075	1	1001428	4014486459364
16	FAN VARI-DRIVE	89515075	1	1001428	4014486459364
17	FAN VARI-DRIVE	9515076	1	1001416	4014486459234
17	FAN VARI-DRIVE	89515076	1	1001416	4014486459234
18	STRAW WALKER SHAFT	80431784	1	1000328	4014486465587
19	SUSPENSION HYDROSTATIC PUMP	89818873	1	1003662	4014486490718
20	ROTARY SEPARATOR DRIVE	89837412	1	1000573	4014486468816
13-14	2HC DRIVE BESIDE STRAW ELEVATOR	84971217	1	1001782	4014486520385

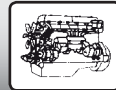

## NEW HOLLAND

### TC 5060

3	DRIVE, ROTARY SCREEN AND FAN	84989965	1	1000169	4014486461954
4	AIR CONDITIONING FAN DRIVE	9818704	1	1000074	4014486483949
4	INTERMEDIATE SHAFT DRIVE	87535206	1	1003727	4014486495164
4	AIR CONDITIONING FAN DRIVE	89818704	1	1000074	4014486483949
7	UNLOADING AUGER DRIVE	84448591	1	1000657	4014486470215
8	HEADER DRIVE ENGAGING IDLER 3HB ONLY	89817374	1	1001876	4014486489231
9	UPPER GROUND SPEED	80356024	1	1001489	4014486459999
10	VARIATOR DRIVE	9850782	1	1001491	4014486460018
10	VARIATOR DRIVE	89850782	1	1001491	4014486460018
11	DRIVE GROUP FOR GRAIN AND TAILINGS ELEVATOR	80422731	1	1000696	4014486470772
12	ECCENTRIC SHAFT DRIVE	80387469	1	1000700	4014486470833
15	DRUM VARI-DRIVE CONTROL	336784	1	1001506	4014486460216
16	FAN VARI-DRIVE	9515075	1	1001428	4014486459364
16	FAN VARI-DRIVE	89515075	1	1001428	4014486459364
17	FAN VARI-DRIVE	9515076	1	1001416	4014486459234
17	FAN VARI-DRIVE	89515076	1	1001416	4014486459234
18	STRAW WALKER SHAFT	80431784	1	1000328	4014486465587
20	ROTARY SEPARATOR DRIVE	89837412	1	1000573	4014486468816
13-14	2HC DRIVE BESIDE STRAW ELEVATOR	84971217	1	1001782	4014486520385

### TC 5070

3	DRIVE, ROTARY SCREEN AND FAN	84989965	1	1000169	4014486461954
4	AIR CONDITIONING FAN DRIVE	9818704	1	1000074	4014486483949
4	AIR CONDITIONING FAN DRIVE	89818704	1	1000074	4014486483949
7	UNLOADING AUGER DRIVE	84448591	1	1000657	4014486470215
8	HEADER DRIVE ENGAGING IDLER 3HB ONLY	89817374	1	1001876	4014486489231
11	DRIVE GROUP FOR GRAIN AND TAILINGS ELEVATOR	80422731	1	1000696	4014486470772
12	ECCENTRIC SHAFT DRIVE	80387469	1	1000700	4014486470833
15	DRUM VARI-DRIVE CONTROL	336784	1	1001506	4014486460216
16	FAN VARI-DRIVE	9515075	1	1001428	4014486459364
16	FAN VARI-DRIVE	89515075	1	1001428	4014486459364
17	FAN VARI-DRIVE	9515076	1	1001416	4014486459234
17	FAN VARI-DRIVE	89515076	1	1001416	4014486459234
18	STRAW WALKER SHAFT	80431784	1	1000328	4014486465587
19	SUSPENSION HYDROSTATIC PUMP	89818873	1	1003662	4014486490718
20	ROTARY SEPARATOR DRIVE	89837412	1	1000573	4014486468816
13-14	2HC DRIVE BESIDE STRAW ELEVATOR	84971217	1	1001782	4014486520385

### TC 5080

3	DRIVE, ROTARY SCREEN AND FAN	84989965	1	1000169	4014486461954
4	AIR CONDITIONING FAN DRIVE	9818704	1	1000074	4014486483949
4	AIR CONDITIONING FAN DRIVE	89818704	1	1000074	4014486483949
7	UNLOADING AUGER DRIVE	84448591	1	1000657	4014486470215
8	HEADER DRIVE ENGAGING IDLER 3HB ONLY	89817374	1	1001876	4014486489231
11	DRIVE GROUP FOR GRAIN AND TAILINGS ELEVATOR	80422731	1	1000696	4014486470772
12	ECCENTRIC SHAFT DRIVE	80387469	1	1000700	4014486470833
15	DRUM VARI-DRIVE CONTROL	336784	1	1001506	4014486460216
16	FAN VARI-DRIVE	9515075	1	1001428	4014486459364
16	FAN VARI-DRIVE	89515075	1	1001428	4014486459364
17	FAN VARI-DRIVE	9515076	1	1001416	4014486459234
17	FAN VARI-DRIVE	89515076	1	1001416	4014486459234
18	STRAW WALKER SHAFT	80431784	1	1000328	4014486465587
19	SUSPENSION HYDROSTATIC PUMP	89818873	1	1003662	4014486490718

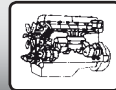
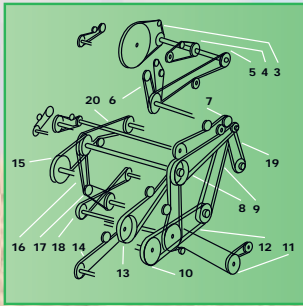

## NEW HOLLAND

20	ROTARY SEPARATOR DRIVE	89837412	1	1000573	4014486468816
13-14	2HC DRIVE BESIDE STRAW ELEVATOR	84971217	1	1001782	4014486520385

### TC 52

3	ROTARY DUST SCREEN DRIVE	89514310	1	1000152	4014486461725
4	RADIATOR FAN (FOR TC52 ONLY)	89831515	1	No AP	
5	ENGINE	89818705	1	1000079	4014486484007
6	ALTERNATOR AND WATERPUMP DRIVE (WITHOUT AIR COMPRESSOR)	84005860	1	1002636	4014486480405
7	INTERMEDIATE SHAFT - ENGINE	9838606	1	1000654	4014486470178
7	INTERMEDIATE SHAFT - ENGINE	89838606	1	1000654	4014486470178
8	BEATER SHAFT - MAIN DRIVE	89817374	1	1001876	4014486489231
11	AUGER (GRAIN)	80422731	1	1000696	4014486470772
12	BEATER SHAFT - ECCENTRIC SHAFT	80387469	1	1000700	4014486470833
13	STRAW ELEVATOR - BEATER SHAFT	80066232	1	1000690	4014486470697
13	STRAW ELEVATOR - BEATER SHAFT	80424563	1	1001765	4014486487480
14	HEADER DRIVE (CODE 0212) TC 52-54	89817487	1	1004471	4014486712131
14	HEADER DRIVE (CODE 0212) TC 52-54	89817488	1	1001780	4014486487671
14	HEADER DRIVE (CODE 1300) FOR L. CONV. TC52-54	89835120	1	1001781	4014486487688
14	HEADER DRIVE (CODE 1300) FOR L. CONV. TC52-54	89839375	1	1000774	4014486471830
15	DRUM - BEATER SHAFT	80336784	1	1001506	4014486460216
16	BEATER SHAFT	89515075	1	1001428	4014486459364
17	FAN DRIVE	89515076	1	1001416	4014486459234
18	STRAW WALKER - ECCENTRIC SHAFT	80431784	1	1000328	4014486465587
19	HYDROSTATIC PUMP (CODE 0800)	89818873	1	1003662	4014486490718
20	ROTARY SEPARATOR (CODE 2300)	89837412	1	1000573	4014486468816

### TC 54

3	ROTARY DUST SCREEN DRIVE	89514310	1	1000152	4014486461725
4	RADIATOR FAN (FOR TC54-56 ONLY)	89818704	1	1000074	4014486483949
5	ENGINE	89818705	1	1000079	4014486484007
6	ALTERNATOR AND WATERPUMP DRIVE (WITHOUT AIR COMPRESSOR)	84005860	1	1002636	4014486480405
7	INTERMEDIATE SHAFT - ENGINE	89838606	1	1000654	4014486470178
8	BEATER SHAFT - MAIN DRIVE	89817374	1	1001876	4014486489231
11	AUGER (GRAIN)	80422731	1	1000696	4014486470772
12	BEATER SHAFT - ECCENTRIC SHAFT	80387469	1	1000700	4014486470833
13	STRAW ELEVATOR - BEATER SHAFT	80066232	1	1000690	4014486470697
13	STRAW ELEVATOR - BEATER SHAFT	80424563	1	1001765	4014486487480
14	HEADER DRIVE (CODE 0212) TC 52-54	89817487	1	1004471	4014486712131
14	HEADER DRIVE (CODE 0212) TC 52-54	89817488	1	1001780	4014486487671
14	HEADER DRIVE (CODE 1300) FOR L. CONV. TC52-54	89835120	1	1001781	4014486487688
14	HEADER DRIVE (CODE 1300) FOR L. CONV. TC52-54	89839375	1	1000774	4014486471830
15	DRUM - BEATER SHAFT	80336784	1	1001506	4014486460216
16	BEATER SHAFT	89515075	1	1001428	4014486459364
17	FAN DRIVE	89515076	1	1001416	4014486459234
18	STRAW WALKER - ECCENTRIC SHAFT	80431784	1	1000328	4014486465587
19	HYDROSTATIC PUMP (CODE 0800)	89818873	1	1003662	4014486490718
20	ROTARY SEPARATOR (CODE 2300)	89837412	1	1000573	4014486468816

### TC 56

3	ROTARY DUST SCREEN DRIVE	89514310	1	1000152	4014486461725
4	RADIATOR FAN (FOR TC54-56 ONLY)	89818704	1	1000074	4014486483949
5	ENGINE	89818705	1	1000079	4014486484007
6	ALTERNATOR AND WATERPUMP DRIVE (WITHOUT AIR COMPRESSOR)	84005860	1	1002636	4014486480405
7	INTERMEDIATE SHAFT - ENGINE	89838606	1	1000654	4014486470178
8	BEATER SHAFT - MAIN DRIVE	89817374	1	1001876	4014486489231

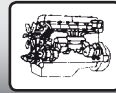
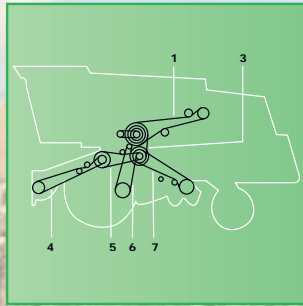
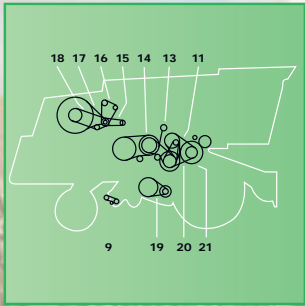

## NEW HOLLAND

11	AUGER (GRAIN)	80422731	1	1000696	4014486470772
12	BEATER SHAFT - ECCENTRIC SHAFT	80387469	1	1000700	4014486470833
13	STRAW ELEVATOR - BEATER SHAFT	80066232	1	1000690	4014486470697
13	STRAW ELEVATOR - BEATER SHAFT	80424563	1	1001765	4014486487480
14	HEADER DRIVE (CODE 0209) TC56	89817487	1	1004471	4014486712131
14	HEADER DRIVE (CODE 0209) TC56	89817488	1	1001780	4014486487671
14	HEADER DRIVE (CODE 1000) FOR L. CONV. TC56	89835120	1	1001781	4014486487688
14	HEADER DRIVE (CODE 1000) FOR L. CONV. TC56	89839375	1	1000774	4014486471830
15	DRUM - BEATER SHAFT	80336784	1	1001506	4014486460216
16	BEATER SHAFT	89515075	1	1001428	4014486459364
17	FAN DRIVE	89515076	1	1001416	4014486459234
18	STRAW WALKER - ECCENTRIC SHAFT	80431784	1	1000328	4014486465587
19	HYDROSTATIC PUMP (CODE 0800)	89818873	1	1003662	4014486490718
20	ROTARY SEPARATOR (CODE 2300)	89837412	1	1000573	4014486468816

### TC 57

1		89838606	1	1000654	4014486470178
4	STRAW ELEVATOR - BEATER SHAFT	80424563	1	1001765	4014486487480
5		80825013	1	1001562	4014486484632
7		80330715	1	1000726	4014486471182
9		80755808	1	1001488	4014486459975
15	BEATER SHAFT	89515075	1	1001428	4014486459364
16	FAN DRIVE	89515076	1	1001416	4014486459234
17		80387460	1	1001537	4014486460568
18	STRAW WALKER - ECCENTRIC SHAFT	80431784	1	1000328	4014486465587

### TF 42

3	BEATER TO INTERMEDIATE SHAFT (MERCEDES ENGINE)	80455865	1	1001954	4014486490596
4	STRAW ELEVATOR DRIVE	80433746	2	1000405	4014486466683
5	BEATER TO STRAW ELEVATOR	80350236	1	1003640	4014486489002
5	BEATER TO STRAW ELEVATOR	80434222	1	1001635	4014486485837
5	BEATER TO STRAW ELEVATOR	80743877	1	1003349	4014486490985
6	GROUND SPEED VARIATOR DRIVE	80440780	1	No AP	
7	SHAKER SHOE DRIVE	80448794	1	1000756	4014486471571
11	BEATER (REAR) TO DRUM SHAFT	80186347	1	1003809	4014486518740
13	INTERMEDIATE SHAFT - ROTARY SEPARATOR	80434047	1	1001602	4014486485240
14	ROTARY SEPARATOR TO ROTOR	80434046	1	1000657	4014486470215
16	MERCEDES ENGINE	80432642	1	1003746	4014486495928
17	DUST CAP	80439495	1	1000173	4014486462005
18	FAN DRIVE	80439496	1	1002609	4014486496161
19	FAN DRIVE	80439832	1	1001415	4014486459227
20	DRUM SHAFT TO INTERMEDIATE SHAFT	80434160	1	No AP	
21	INTERMEDIATE SHAFT - GRAIN ELEVATOR	80433639	1	1000237	4014486463408

### TF 44

3	BEATER TO INTERMEDIATE SHAFT (MERCEDES ENGINE)	80455865	1	1001954	4014486490596
4	STRAW ELEVATOR DRIVE	80433746	2	1000405	4014486466683
5	BEATER TO STRAW ELEVATOR	80350236	1	1003640	4014486489002
5	BEATER TO STRAW ELEVATOR	80434222	1	1001635	4014486485837
5	BEATER TO STRAW ELEVATOR	80743877	1	1003349	4014486490985
6	GROUND SPEED VARIATOR DRIVE	80440780	1	No AP	
7	SHAKER SHOE DRIVE	80448794	1	1000756	4014486471571
11	BEATER (REAR) TO DRUM SHAFT	80186347	1	1003809	4014486518740
13	INTERMEDIATE SHAFT - ROTARY SEPARATOR	80434047	1	1001602	4014486485240
14	ROTARY SEPARATOR TO ROTOR	80434046	1	1000657	4014486470215

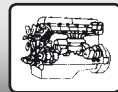

## NEW HOLLAND

16	MERCEDES ENGINE	80432642	1	1003746	4014486495928
17	DUST CAP	80439495	1	1000173	4014486462005
18	FAN DRIVE	80439496	1	1002609	4014486496161
19	FAN DRIVE	80439832	1	1001415	4014486459227
20	DRUM SHAFT TO INTERMEDIATE SHAFT	80434160	1	No AP	
21	INTERMEDIATE SHAFT - GRAIN ELEVATOR	80433639	1	1000237	4014486463408
<b>TF 46</b>					
1	BEATER TO INTERMEDIATE DRIVE	80750166	1	1001242	4014486491975
2	MAIN DRIVE 4HB	750290	1	1002008	4014486491371
2	MAIN DRIVE 4HB	80750290	1	1002008	4014486491371
3	DRUM DRIVE	84817628	1	1003345	4014486469844
4	STRAW ELEVATOR DRIVE - WITH LATERAL FLOTATION, 7401001 - 7406999	80453268	2	1000319	4014486465389
4	COUNTERSHAFT	80919681	1	1001602	4014486485240
5	GRAIN ELEVATOR DRUM DRIVE 3HB	84817632	1	1003639	4014486488999
5	GRAIN TANK UNLOADING	84817636	1	1003404	4014486463255
6	CLEANING SHOE DRIVE	448794	1	1000756	4014486471571
6	INTERMEDIATE SHAFT DRIVE	89832601	1	1001288	4014486497861
7	ROTARY SEPARATOR	84448591	1	1000657	4014486470215
8	ROTOR TO UNDERSHOT BEATER	80427456	1	1003351	4014486464603
9	FAN DRIVE	80750318	1	1001134	4014486497182
9	ROTARY DUST SCREEN DRIVE, 7404001 - 7409999	87374615	1	1004049	4014486518436
10	COOLING FAN DRIVE - INTERMEDIATE SHAFT	80439496	1	1002609	4014486496161
11	WATERPUMP AND ALTERNATOR DRIVE, 7416001 - 7418999	452023	2	1002976	4014486495997
11	WATERPUMP AND ALTERNATOR DRIVE, 7401001 - 7415999	80748003	2	1002974	4014486495935
12	DUST - SCREEN BELT	80436304	1	1002482	4014486493788
14	MAIN DRIVE 2HB	84000191	1	1003616	4014486486667
16	CHOPPER DRIVE, 7422001 -	84000189	1	1000666	4014486470338
17	CHOPPER DRIVE, 7410001 -	80457309	1	1000181	4014486462104
18	WATERPUMP DRIVE	80443634	1	1002543	4014486494723
<b>TF 76</b>					
1	MAIN DRIVE BELT	84817623	1	1001954	4014486490596
2	HYDROSTATIC DRIVE	84817631	1	1002006	4014486491340
3	FAN DRIVE	84817629	1	1001557	4014486484564
4	DRIVE BESIDES STRAW ELEVATOR 4HB	9593400	1	1002029	4014486491647
4	GRAIN ELEVATOR DRIVE	89593418	1	No AP	
5	BEATER TO STRAW ELEVATOR 2HB	80434222	1	1001635	4014486485837
5	BEATER TO STRAW ELEVATOR 2HB	84817632	1	1003639	4014486488999
6	SHAKER SHOE DRIVE	448794	1	1000756	4014486471571
10	CHOPPER, DRIVE FOR TF76 ONLY	84000189	1	1000666	4014486470338
12	DRUM DRIVE	84817628	1	1003345	4014486469844
13	EXTENSION COUNTERSHAFT	80919681	1	1001602	4014486485240
14	AUGER DRIVE	84817636	1	1003404	4014486463255
15	BEATER TO INTERMEDIATE DRIVE	89832601	1	1001288	4014486497861
16	ROTARY SEPARATOR	84448591	1	1000657	4014486470215
17	THROW-OUT BEATER DRIVE	80427456	1	1003351	4014486464603
18	CLEANING FAN DRIVE	84817627	1	1001135	4014486497199
21		84000189	1	1000666	4014486470338
22	CENTRIFUGAL SEPARATOR	84817639	1	1002608	4014486496154
23	ALTERNATOR, WATERPUMP AND FAN	84817638	1	1003807	4014486483048
24	HYDRAULIC PUMP	84817670	2	1002969	4014486495584
25	CLEANING FAN DRIVE	84817630	1	1002606	4014486496130
26	COMPRESSOR DRIVE	84817626	1	1002579	4014486495560
27	ROTARY SIEVE	84022715	1	No AP	



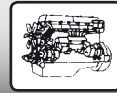
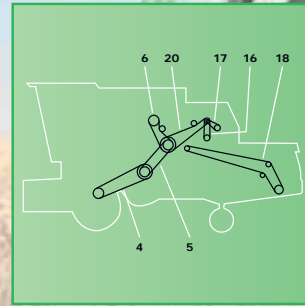
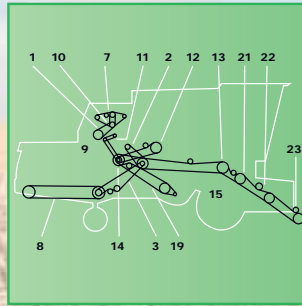
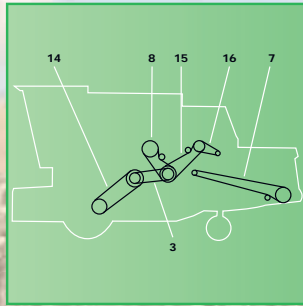
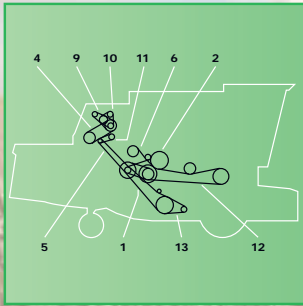

## NEW HOLLAND

### TF 78

1	THRESHING, DRIVE, BELT AND GUARD	80750166	1	1001242	4014486491975
2	HYDROSTATIC DRIVE	84817631	1	1002006	4014486491340
3	FAN DRIVE 2 HB	84817629	1	1001557	4014486484564
4	DRIVE BESIDES STRAW ELEVATOR 4HB	9593400	1	1002029	4014486491647
4	GRAIN ELEVATOR DRIVE	89593418	1	No AP	
5	BEATER TO STRAW ELEVATOR 2HB	80434222	1	1001635	4014486485837
5	BEATER TO STRAW ELEVATOR 2HB	84817632	1	1003639	4014486488999
6	SHAKER SHOE DRIVE	448794	1	1000756	4014486471571
10	CHOPPER, DRIVE FOR TF78 ONLY	84000189	1	1000666	4014486470338
12	DRUM DRIVE	84817628	1	1003345	4014486469844
13	EXTENSION COUNTERSHAFT	80919681	1	1001602	4014486485240
14	AUGER DRIVE	84817636	1	1003404	4014486463255
15	BEATER TO INTERMEDIATE DRIVE	89832601	1	1001288	4014486497861
16	ROTARY SEPARATOR	84448591	1	1000657	4014486470215
17	THROW-OUT BEATER DRIVE	80427456	1	1003351	4014486464603
18	CLEANING FAN DRIVE	84817627	1	1001135	4014486497199
22	ROTARY SCREEN DRIVE	84021588	1	1000083	4014486519358
23	AIR CONDITIONER, ENGINE PARTS	84007307	2	1002605	4014486496123
24	HYDRAULIC PUMP	89835816	1	1002588	4014486495812
25	ROTARY SCREEN DRIVE	84021590	1	1000082	4014486519341

### TL80

	FAN BELT	4796327	1	1002461	4014486493450
--	----------	---------	---	---------	---------------

### TL90

	FAN BELT	4796327	1	1002461	4014486493450
--	----------	---------	---	---------	---------------

### TN60VA

	AIR CONDITIONING COMPRESSOR DRIVE	87324567	1	1002575	4014486495478
--	-----------------------------------	----------	---	---------	---------------

### TN65V

	AIR CONDITIONING COMPRESSOR DRIVE	87324567	1	1002575	4014486495478
--	-----------------------------------	----------	---	---------	---------------

### TN70VA

	AIR CONDITIONING COMPRESSOR DRIVE	87324567	1	1002575	4014486495478
--	-----------------------------------	----------	---	---------	---------------

### TN75VA

	AIR CONDITIONING COMPRESSOR DRIVE	87324567	1	1002575	4014486495478
--	-----------------------------------	----------	---	---------	---------------

### TN95VA

	AIR CONDITIONING COMPRESSOR DRIVE	87324567	1	1002575	4014486495478
--	-----------------------------------	----------	---	---------	---------------

### TR 70

6	ROTOR DRIVE (OPT FOR HIGH SPEED)	715785	1	1004170	4014486522808
10	ALTERNATOR AND FAN DRIVE (CATERPILLAR ENGINE DIESEL)	626654	2	1002963	4014486495324

### TR 75

11	ROTARY SCREEN (UPPER)	716254	1	No AP	
13	HEADER DRIVE 193	682008	1	1004122	4014486522969
17	AIR COMPRESSOR - 48	259346	1	1004159	4014486523379
17	AIR COMPRESSOR - 48	80259346	1	1004159	4014486523379
22	FEEDER HOUSE FIXED SPEED	621367	1	1004120	4014486522945

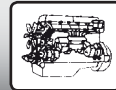
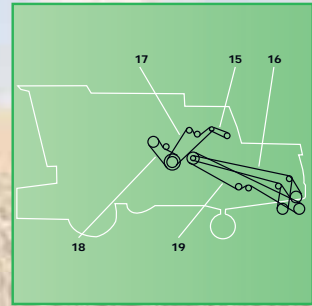
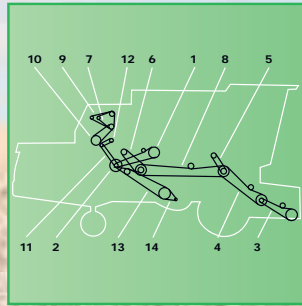
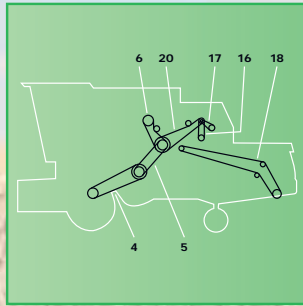
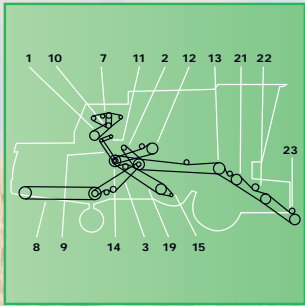

## NEW HOLLAND

### TR 85

11	ROTARY SCREEN (UPPER)	716254	1	No AP	
13	HEADER DRIVE 193	682008	1	1004122	4014486522969
17	AIR COMPRESSOR - 48	259346	1	1004159	4014486523379
22	FEEDER HOUSE FIXED SPEED	621367	1	1004120	4014486522945

### TR 86

4	FEEDER HOUSE FIXED SPEED	621367	1	1004120	4014486522945
4	FEEDER DRIVE VARIABLE SPEED	849514	1	1004169	4014486522792
4	SMALL GRAIN SPECIAL	9613963	1	1004140	4014486523201
7	ENGINE FAN HYDRAULIC PUMP	855676	1	1003746	4014486495928
8	HEADER DRIVE	682008	1	1004122	4014486522969
9	ALTERNATOR DRIVE	626654	2	1002963	4014486495324
10	HYDRAULIC PUMP DRIVE	855676	1	1003746	4014486495928
12	ROTARY SCREEN DRIVE (SECONDARY)	716254	1	No AP	
15	AIR CONDITIONING COMPRESSOR DRIVE	259346	1	1004159	4014486523379
15	AIR CONDITIONING COMPRESSOR DRIVE	577240	1	1002565	4014486495225

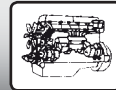
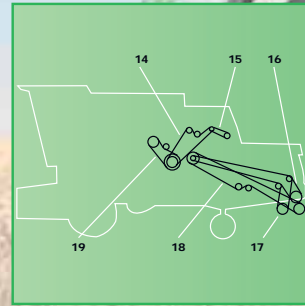
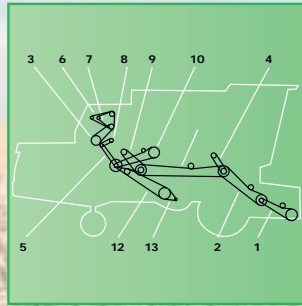
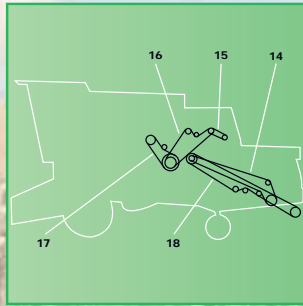
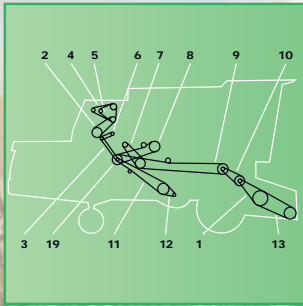

## NEW HOLLAND

### TR 95

1	FEEDER HOUSE FIXED SPEED	621367	1	1004120	4014486522945
2	HYDRAULIC PUMP DRIVE	624650	2	1002841	4014486464078
3	ROTARY SCREEN DRIVE	615790	1	1004108	4014486522839
4	ALTERNATOR AND WATERPUMP DRIVE	626654	2	1002963	4014486495324
6	ALTERNATOR DRIVE	626657	1	1002568	4014486495317
6	ROTARY SCREEN DRIVE (SECONDARY)	716254	1	No AP	
11	SHAKER SHOE DRIVE	774747	1	1001633	4014486485783
12	CLEANING FAN - VARIATOR DRIVE (WITHOUT SLOW DOWN)	710752	1	1004167	4014486522778
12	CLEANING FAN - VARIATOR DRIVE (WITHOUT INT.SPEED KIT)	773300	1	1004168	4014486522785
15	AIR CONDITIONING COMPRESSOR DRIVE 48	259346	1	1004159	4014486523379
16	HYDROSTATIC PUMP DRIVE AND MAIN SHAFT	649035	1	1004151	4014486523324
18	STRAW SPREADER DRIVE	618040	1	1004117	4014486522914

### TR 96

2	FEEDER HOUSE FIXED SPEED	621367	1	1004120	4014486522945
2	FEEDER DRIVE VARIABLE SPEED	849514	1	1004169	4014486522792
2	SMALL GRAIN SPECIAL - 3HB	9613963	1	1004140	4014486523201
3	HYDRAULIC PUMP DRIVE	624650	2	1002841	4014486464078
3	ENGINE FAN DRIVE	768340	2	1004158	4014486554397
3	ENGINE FAN AND HYDRAULIC PUMP	855676	1	1003746	4014486495928
5	ROTARY SCREEN DRIVE (PRIMARY)	615790	1	1004108	4014486522839
5	ROTARY SCREEN DRIVE (PRIMARY)	859063	1	1004164	4014486522983
6	ALTERNATOR DRIVE	626654	2	1002963	4014486495324
6	ALTERNATOR DRIVE	626657	1	1002568	4014486495317
8	ROTARY SCREEN DRIVE (SECONDARY)	716254	1	No AP	
10	CLEAN GRAIN ELEVATOR DRIVE IMPROVED	9604713	1	1004126	4014486523089
11	HEADER DRIVE	682008	1	1004122	4014486522969
12	SHAKER SHOE DRIVE	774747	1	1001633	4014486485783
14	HYDROSTATIC - MAIN SHAFT DRIVE	649035	1	1004151	4014486523324
14	HYDROSTATIC - MAIN SHAFT DRIVE	797979	1	1004152	4014486523331
15	AIR CONDITIONING COMPRESSOR DRIVE	259346	1	1004159	4014486523379
15	AIR CONDITIONING COMPRESSOR DRIVE	626657	1	1002568	4014486495317
16	STRAW SPREADER DRIVE	618040	1	1004117	4014486522914

### TR 97

1	ENGINE FAN HYDRAULIC PUMP	855676	1	1003746	4014486495928
6	CLEAN GRAIN ELEVATOR DRIVE IMPROVED	9604713	1	1004126	4014486523089
7	HEADER DRIVE	682008	1	1004122	4014486522969
8	HYDRAULIC REEL PUMP DRIVE	9609607	1	1000230	4014486463187
9	ROTARY SCREEN DRIVE (PRIMARY)	859063	1	1004164	4014486522983
10	SHAKER SHOE DRIVE	774747	1	1001633	4014486485783
13	FEEDER HOUSE FIXED SPEED	621367	1	1004120	4014486522945
15	HYDROSTATIC - MAIN SHAFT DRIVE	797979	1	1004152	4014486523331
16	AIR CONDITIONING COMPRESSOR DRIVE	626657	1	1002568	4014486495317
17	STRAW SPREADER DRIVE	618040	1	1004117	4014486522914

### TR 98

1	HYDRAULIC PUMP DRIVE	773255	1	1002582	4014486495638
4	ROTOR VARIATOR DRIVE - STANDARD SPEED ROTOR	86518568	1	No AP	
6	CLEAN GRAIN ELEVATOR DRIVE IMPROVED	9604713	1	1004126	4014486523089
7	HEADER DRIVE	86503087	1	1004123	4014486522976
8	HYDRAULIC REEL PUMP DRIVE	9609607	1	1000230	4014486463187
9	ROTARY SCREEN DRIVE (PRIMARY)	859063	1	1004164	4014486522983

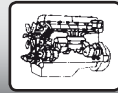
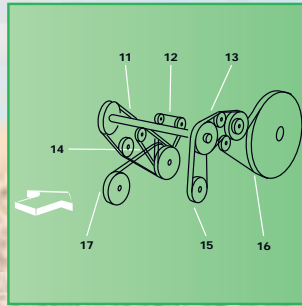
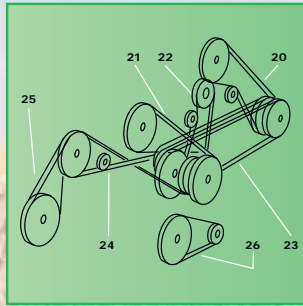
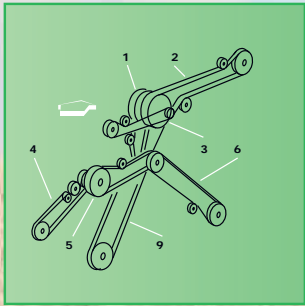

## NEW HOLLAND

10	SHAKER SHOE DRIVE	774747	1	1001633	4014486485783
13	FEEDER HOUSE FIXED SPEED	9613963	1	1004140	4014486523201
16	AIR CONDITIONING COMPRESSOR DRIVE	577240	1	1002565	4014486495225
17	STRAW SPREADER DRIVE	618040	1	1004117	4014486522914
20	UNLOADING AUGER DRIVE	86514256	1	1004119	4014486522938

### TX 30

1	BEATER TO INTERMEDIATE DRIVE	80455865	1	1001954	4014486490596
2	HYDROSTATIC DRIVE - ENGINE TO BEATER SHAFT	80922872	1	1003667	4014486491302
2	ENGINE TO BEATER SHAFT - MECHANICAL DRIVE	80922911	1	1002004	4014486491319
3	UNLOADING AUGER ENGAGING	89512971	1	1003801	4014486518634
4	STRAW ELEVATOR DRIVE	80433746	2	1000405	4014486466683
5	BEATER TO STRAW ELEVATOR	80350236	1	1003640	4014486489002
6	CLEANING SHOE DRIVE	80448794	1	1000756	4014486471571
9	GROUND SPEED VARIATOR DRIVE	80440780	1	No AP	
11	COOLING FAN DRIVE - INTERMEDIATE SHAFT	80913151	1	1003429	4014486464221
12	WATERPUMP DRIVE	80443634	1	1002543	4014486494723
13	ROTARY DUST SCREEN DRIVE	80913153	1	1000081	4014486484021
16	DUST SCREEN DRIVE	80923019	1	1000166	4014486461916
20	BEATER DRIVE	89513984	1	1000631	4014486469837
21	ROTARY SEPARATOR DRIVE	80754285	1	1000594	4014486469233
22	STORAGE DRIVE GRAIN	80433639	1	1000237	4014486463408
23	DRUM SHAFT TO INTERMEDIATE SHAFT	80434160	1	No AP	
24	STRAW WALKER - INTERMEDIATE SHAFT DRIVE	80754389	1	1003339	4014486465426
25	STRAW WALKER DRIVE	80754388	1	1003341	4014486462999
26	CLEANING FAN - VARIATOR DRIVE	89502654	1	1001135	4014486497199













## ROSTSELMACH

4	CUTTING DRUM	6201348	1	1002730	4014486472950
7	SHAKER SHAFT DRIVE	6201326	4	1003317	4014486472226
7	COUNTER DRIVE MAIN (REAR)	6201354	1	1000972	4014486474329
9	AUGER FOR UNLOADING	6201316	1	1001609	4014486485363
18	CUTTING DRUM	6201017	1	1000835	4014486472622
19	STACKER DRIVE	6201353	1	1000970	4014486474299
23	TILTED PLATFORM CHAMBER SHAFT (UPPER)	6201290	1	1002702	4014486474121
		6201005	1	1000204	4014486462449
		6201006	1	1002701	4014486474138
		6201022	1	1000729	4014486471212
		6201023	1	1000830	4014486472561
		6201029	1	1001661	4014486486179
		6201080	1	1002300	4014486479881
		6201081	1	1002518	4014486494334
		6201083	1	1002715	4014486492668
		6201084	1	1002703	4014486485691
		6201085	1	1002714	4014486492583
		6201086	1	1002716	4014486488692
		6201087	1	1002719	4014486476132
		6201088	1	1002704	4014486486681
		6201089	1	1002705	4014486486261
		6201091	1	1003314	4014486477832
		6201096	1	1001082	4014486496642
		6201097	1	1000239	4014486463439
		6201195	1	1002014	4014486491449
		6201196	1	1001301	4014486492576
		6201265	1	1002716	4014486488692
		6201277	1	1002232	4014486477948
		6201298	1	1003688	4014486477979
		6201315	1	1000342	4014486465914
		6201317	1	1002706	4014486485547
		6201318	1	1002707	4014486486452
		6201319	1	1002718	4014486488784
		6201320	1	1002713	4014486492651
		6201322	1	1002712	4014486492590
		6201324	1	1002724	4014486476392
		6201329	1	1002725	4014486490909
		6201330	1	1003323	4014486485677
		6201335	1	1003331	4014486489224
		6201339	1	1003680	4014486477061
		6201340	1	1002708	4014486486988
		6201341	1	1002726	4014486491142
		6201342	1	1003319	4014486472097
		6201349	1	1002728	4014486470918
		6201350	1	1002729	4014486472691
		6201356	1	1003325	4014486466911
		6201357	1	1002700	4014486466942
		6201358	1	1002727	4014486471113
		6201363	1	1001617	4014486485479
		6201373	1	1001102	4014486496840
		6201379	1	1003751	4014486519921
		6201380	1	1001963	4014486490725
		6201381	1	1000114	4014486461220
		6201382	1	1001575	4014486484809
		6201383	1	1002709	4014486485097

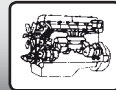
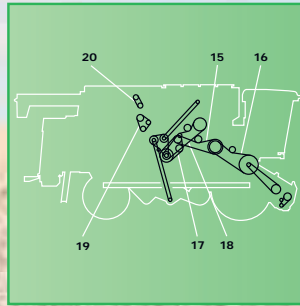
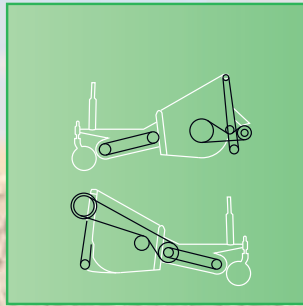
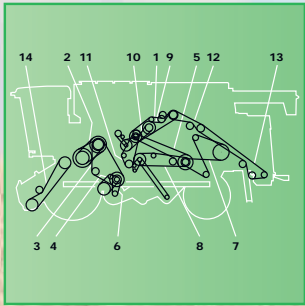

		6201384	1	1003771	4014486519877
		6201387	1	1002121	4014486476231
		6201392	1	1001654	4014486486070
		6201393	1	1004311	4014486719628
		6201394	1	1001998	4014486491241
		6201396	1	1002135	4014486476477
		6201397	1	1001582	4014486484892
		6201399	1	1001921	4014486489897
		6201400	1	1001663	4014486486193
		6201401	1	1000174	4014486462029
		6201403	1	1001324	4014486492866
		6201404	1	1001638	4014486485882
		6201405	1	1000226	4014486463026
		6201406	1	1000171	4014486461978
		6201408	1	1002711	4014486491968
		6201411	1	1002358	4014486478921
		6201412	1	1003327	4014486463231
		6201413	1	1002654	4014486491388
		6201414	1	1002559	4014486495072
		6201415	1	1002717	4014486488203
		6201416	1	1002731	4014486483604
		6201417	1	1002732	4014486461985
		6201418	1	1002734	4014486480290
		6201419	1	1001604	4014486485295
		6201420	1	1002705	4014486486261
		6201421	1	1002142	4014486476545
		6201422	1	1002733	4014486483536
		6201424	1	1002710	4014486485875
		6201426	1	1003933	4014486485301
		6201428	1	1004523	4014486719291
		6201432	1	1004895	4014486721973
		6201437	1	1004703	4014486719284
		6201461	1	1002537	4014486494600

#### ACROS 530

1	MAIN COUNTERSHAFT DRIVE	6201249	1	1001306	4014486492644
2	DRUM DRIVE VARIABLE SPEED	6201246	1	1001291	4014486497885
3	CLEANING FAN - COUNTERSHAFT	6201297	2	1002229	4014486477917
4	CLEANING SHAFT DRIVE	6201269	2	1003778	4014486476316
5	COUNTER DRIVE (REAR)	6201378	1	1001673	4014486486377
6	CLEANING FAN DRIVE	6201273	1	1001003	4014486497267
8	ELEVATOR DRIVE UNIT	6201275	2	1003315	4014486477535
11	FINAL THRESHING UNIT	6201376	2	1003005	4014486476729
13	CUTTING DRUM	6201375	1	1001700	4014486486766
14	TRANSMISSION SHAFT	6201094	1	1002007	4014486491357
15	BEATER DRIVE	6201377	1	1001305	4014486492637
16	TILTED PLATFORM CHAMBER SHAFT	6201251	1	1003329	4014486491197
17	COUNTER DRIVE GRAIN	6201263	2	1002213	4014486477641
19	DUST REMOVING FAN	6201028	1	1000217	4014486462760
20	AIR CONDITIONING COMPRESSOR DRIVE	6201371	1	1002529	4014486494488
23	CUTTING UNIT DRIVE	6201271	2	1002226	4014486477849





















## SAMPO

	1472227	1	1004159	4014486523379
	0613116	1	1000104	4014486461077
	0613122	1	1003818	4014486478716
	0613124	1	1000115	4014486461237
	0613126	1	1002059	4014486475371
	0613128	1	1000118	4014486461275
	0614115	1	1003394	4014486462692
	0614125	1	1000238	4014486463422
	0614136	1	1000275	4014486464467
	0614148	1	1000325	4014486465518
	0614150	1	1000339	4014486520217
	0614152	1	1000343	4014486465921
	0614166	1	No AP	
	0614212	1	1000235	4014486463361
	0614215	1	1002304	4014486479928
	0614217	1	1003839	4014486463538
	0614222	1	1003840	4014486463903
	0614224	1	1000257	4014486464047
	0614225	1	1003834	4014486464146
	0614226	1	1003841	4014486464139
	0614227	1	1000269	4014486464320
	0614242	1	1000300	4014486464979
	0614246	1	1000313	4014486465273
	0614260	1	1000370	4014486466331
	0615108	1	1000548	4014486468359
	0615109	1	1003820	4014486468632
	0615116	1	1000575	4014486468847
	0615124	1	1003821	4014486469721
	0615128	1	1000645	4014486470055
	0615129	1	1000664	4014486470307
	0615130	1	1000646	4014486470062
	0615135	1	1000652	4014486470154
	0615139	1	1004894	4014486721980
	0615146	1	1000781	4014486471922
	0615147	1	1000803	4014486472233
	0615151	1	1003556	4014486472615
	0615159	1	1000755	4014486471557
	0615168	1	1003822	4014486469967
	0615170	1	1000622	4014486469660
	0615173	1	1003516	4014486469677
	0615179	1	1000669	4014486470376
	0615184	1	1000745	4014486471410
	061533	1	1000698	4014486470802
	0619054	1	1001590	4014486485028
	0619062	1	1004867	4014486735079
	0619065	1	1001633	4014486485783
	0619070	1	No AP	
	0619080	1	1001839	4014486488654
	0619081	1	1001616	4014486485462
	0619083	1	1003825	4014486459692
	0619085	1	1003854	4014486486926
	0619087	1	1004566	4014486717310
	0619090	1	1001898	4014486489576
	0619168	1	1003823	4014486460056
	0619169	1	1001502	4014486460179



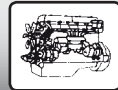

## STOLL

	464580	1	1004237	4014486675726
	465620	1	1004201	4014486675511
	465930	1	1004240	4014486675757
	470590	1	1004241	4014486675764
	497480	1	1004238	4014486675733
	497540	1	1004204	4014486675528
	1592600	1	1004239	4014486675740
	0071480	1	1004228	4014486675634
	0204480	1	1004229	4014486675641
	0204510	1	1004234	4014486675696
	0401820	1	1004243	4014486675801
	0402980	1	1004236	4014486675719
	0425540	1	1003501	4014486469059
	0440800	1	1003552	4014486471991
	0441330	1	1004036	4014486518481
	0441770	2	1001059	4014486522754
	0441840	1	1004221	4014486675542
	0441860	1	1004248	4014486675931
	0443880	1	1004230	4014486675658
	0445510	1	1003677	4014486476620
	0451680	1	1002153	4014486476712
	0453850	1	1002117	4014486476170
	0455990	2	1004233	4014486675689
	0456660	1	1003680	4014486477061
	0457280	1	1002166	4014486476910
	0462560	1	1004235	4014486675702
	0462680	2	1004246	4014486675917
	0464590	2	1004222	4014486675566
	0465180	1	1004242	4014486675771
	0465510	2	1004219	4014486675559
	0465530	1	1000602	4014486469349
	0465850	1	1004218	4014486675535
	0465860	1	1000245	4014486463712
	0467010	1	1004227	4014486675627
	0467390	1	1004223	4014486675573
	0467640	1	1004225	4014486675597
	0469250	1	1004247	4014486675924
	0469800	2	1004244	4014486675894
	0469810	1	1004250	4014486675955
	0474850	2	1004224	4014486675580
	0476430	1	1000541	4014486468236
	0476440	1	1004232	4014486675672
	0479100	1	1004249	4014486675948
	0480490	2	1004226	4014486675603
	0488950	1	1004245	4014486675900
	0496030	3	1004231	4014486675665
	1361-2406	1	1003484	4014486468281
	1361-3202	1	1000263	4014486464191
	1361-3404	1	1000587	4014486469080
	1361-4101	1	1000272	4014486464429
	1361-4401	1	1000590	4014486520255
	1361-4402	1	1000591	4014486469172
	1361-4403	1	1000602	4014486469349
	1361-5202	1	1000300	4014486464979
	1361-5402	1	1000609	4014486469486

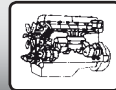

## STOLL

	1361-5404	1	1000624	4014486520262
	1361-5405	1	1000625	4014486469738
	1361-5501	1	1000940	4014486473933
	1361-5502	1	1000939	4014486473926
	1361-6102	1	1003454	4014486465761
	1361-6401	1	1000670	4014486470383
	1361-6402	1	1000643	4014486470031
	1361-6404	1	1000652	4014486470154
	1361-6405	1	1000659	4014486470239
	1361-6406	1	1000628	4014486469783
	1361-6407	1	1000633	4014486469868
	1361-6410	1	1000647	4014486470079
	1361-6501	1	1000946	4014486474015
	1361-7403	1	1000703	4014486470871
	1361-7502	1	1000949	4014486474046
	1361-8110	1	1000424	4014486466874
	1361-8300	1	1003555	4014486472448
	1361-8303	1	1003553	4014486472264
	1361-8304	1	1000807	4014486472301
	1361-8307	1	1003549	4014486471816
	1361-8308	1	1000777	4014486471878
	1361-8310	1	1000782	4014486471946
	1361-8311	1	1000779	4014486471915
	1361-8401	1	1000719	4014486471106
	1361-8403	1	1000706	4014486470925
	1361-8503	2	1004205	4014486675450
	1361-8505	1	1004203	4014486675443
	1361-8507	1	1004206	4014486675467
	1361-8508	1	1000967	4014486474268
	1361-8509	1	1000966	4014486474251
	1361-8511	1	1000975	4014486474350
	1361-8512	1	1000976	4014486474367
	1361-9601	1	1000894	4014486473360
	1361-9605	1	1000921	4014486473704
	1361-9608	1	1000932	4014486473834
	1361-9614	1	1004202	4014486675436
	1361-9615	1	1001034	4014486496338
	1361-9618	1	1000974	4014486474343
	1361-9703	1	1002127	4014486476309
	1361-9706	1	1002169	4014486477016
	1361-9707	1	1003677	4014486476620
	1361-9709	1	1002170	4014486477030
	1361-9715	1	1004216	4014486675870
	1361-9718	1	1004215	4014486675863
	1361-9733	1	1002364	4014486478983
	1361-9737	1	1002185	4014486477290
	1361-9804	1	1002126	4014486476286
	1361-9805	1	1002122	4014486476248
	1361-9901	1	1002217	4014486477702
	1361-9906	1	1003316	4014486477900
	1361-9908	1	1002224	4014486477818
	1362-1001	5	1003048	4014486478556
	1362-1002	5	1003050	4014486519211
	1362-1003	4	1003678	4014486476750
	1362-1004	3	1002134	4014486476446

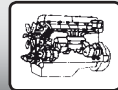

## STOLL

	1362-1005	4	1002326	4014486478549
	1362-1006	4	1001285	4014486480283
	1362-1007	4	1003049	4014486478600
	1362-1008	2	1000219	4014486462814
	1362-1009	4	1002156	4014486476767
	1362-1010	4	1004304	4014486683028
	1362-1011	4	1003255	4014486477023
	1362-1012	4	1002116	4014486476187
	1362-1013	5	1002392	4014486479331
	1362-1014	4	1002394	4014486479355
	1362-1015	3	1004211	4014486675825
	1362-1016	4	1002164	4014486476897
	1362-1017	4	1004305	4014486683035
	1362-1018	3	1004208	4014486675788
	1362-1205	2	1003761	4014486462630
	1362-1207	2	1002836	4014486462746
	1362-1208	2	1002810	4014486462968
	1362-1209	2	1000234	4014486463330
	1362-1210	1	1004220	4014486675610
	1362-2106	3	1002838	4014486463736
	1362-2202	3	1002840	4014486519990
	1362-2405	2	1000549	4014486468373
	1362-2407	2	1000551	4014486468397
	1362-3105	4	1002787	4014486464412
	1362-3205	4	1002842	4014486464153
	1362-4105	4	1002890	4014486472080
	1362-6101	4	1002769	4014486465211
	1362-8304	2	1004200	4014486675429
	1362-8408	4	1002891	4014486471861
	1362-8505	4	1002912	4014486474237
	1362-9702	5	1003053	4014486479133
	1362-9704	4	1004209	4014486675795
	1362-9705	3	1002130	4014486476354
	1362-9707	3	1004210	4014486675818
	1362-9708	3	1004212	4014486675832
	1362-9713	5	1003054	4014486479447
	1362-9716	2	1002379	4014486479157
	1362-9719	3	1002397	4014486479386
	1362-9720	4	1002165	4014486476903
	1362-9721	3	1003055	4014486479201
	1362-9722	4	1002378	4014486479140
	1362-9723	4	1002387	4014486479263
	1362-9724	4	1002368	4014486479034
	1362-9725	2	1004217	4014486675887
	1362-9727	4	1002380	4014486479164
	1362-9730	4	1003028	4014486477399
	1362-9732	4	1002192	4014486477405
	1362-9733	5	1002365	4014486479003
	1362-9737	4	1004213	4014486675849
	1362-9803	4	1002112	4014486476125
	1362-9806	2	1004207	4014486675474
	1362-9906	3	1004214	4014486675856







# PART NUMBER

PART NUMBER	OPTIBELT AP
<b>AGCO</b>	
56325	1000577
270412	1001799
270791	1001817
290331	1001051
400875	No AP
432244	1000224
432433	1000684
433128	1000103
433417	1003272
433435	1000702
433440	1000724
433442	1000755
433531	1000950
433537	1000959
434140	1000999
435125	1001174
435127	1001175
526155	1001953
526369	1000286
526370	1002751
527975	1001959
527976	1002752
703899	1001461
761757	1002753
765173	1003594
765174	1001597
855007	1000740
855122	1001185
855650	1002754
855718	1001281
855791	1000817
856047	1001824
856112	1001011
856401	1000646
856641	1002858
857219	1000703
1710292	1001282
4311315	1001975
4311316	1001976
7855331	1000649
7855349	1001609
7855810	1001878
26732797	1002193
26732815	1001902
26732820	1001749
26732833	1000794
26733247	1003410
26733248	1000343
26733312	1001223
26733578	1002759
26733588	1002762
26733596	1002763
26735939	1001637
28284841	1000764
41900000	1000037
41903400	1000092
41903700	1003739

PART NUMBER	OPTIBELT AP
41903800	1003722
41904200	1003706
41904300	1003708
41905600	1000116
41907500	1000128
41907800	1000134
41916800	1000181
41921700	1002369
41924700	1003334
41925200	1000211
41926500	1000235
41928400	1000243
41929400	1000252
41930600	1000262
41931100	1000287
41931600	1000272
41933400	1000298
41933900	1002767
41936300	1000321
41936500	1003453
41936800	1002771
41938000	1003457
41941100	1000392
41941900	1000351
41943600	1000414
41951700	1003487
41953300	1003508
41954300	1003529
41955500	1003544
41956500	1003550
41957500	1000673
41958600	1000860
41963800	1000241
41965100	1003431
41973000	1001356
41976200	1001359
41977600	1001726
41977700	1001669
41977800	1001666
41977900	1001728
41978300	1001250
41978700	1001732
41981400	1001437
41981500	1001538
41982000	1002860
41982300	1002862
41982600	1000669
41983200	1000809
41983300	1002863
41984900	1002864
41985400	1000839
41985700	1000694
41985900	1000648
41987400	1000866
41987500	1000874
41988600	1000900
41989000	1000910
41989800	1000905
41990011	1002362

PART NUMBER	OPTIBELT AP
41990012	1002328
41990013	1003770
41990014	1002335
41990019	1002359
41990020	1002324
41990021	1002339
41990022	1002338
41990026	1002361
41990037	1003565
41990045	1001947
41990047	1001677
41990048	1001722
41990049	1001675
41990053	1001874
41990054	1001812
41990055	1001816
41990056	1003658
41990058	1001945
41990060	1001254
41990061	1001946
41990062	1004092
41990063	1001815
41990065	1001992
41990700	1002571
41990800	1002945
41991100	1002355
41992000	1003604
41992300	1001614
41993800	1001950
41994500	1002001
41995000	1002070
41997500	1002185
41997900	No AP
41999100	1002345
45055100	1002051
46301055	1002268
46301057	1002556
46488200	1001046
49906200	1002056
70260149	1002604
70267630	1002987
70268485	1002559
70273193	1002740
71132108	1001093
71135618	1001395
71139963	1001447
71146271	1003607
71147547	1001567
71157414	1001490
71161595	1001605
71161596	1001623
71164177	1003610
71164350	1001498
71165927	No AP
71167114	1001521
71167409	1001661
71170490	1001475
71175575	1001585
71175687	1000073

# PART NUMBER



PART NUMBER	OPTIBELT AP
71175989	1003603
71176492	1000253
71177537	1001856
71187728	1001386
71187779	1000577
71193749	1002557
71197876	1001500
71197999	1003636
71300867	1000800
71300996	1001495
71302482	1002946
71309140	1001558
71309150	1000391
71309685	1001057
71310380	1001387
71310381	1001972
71310382	1001638
71313804	1000280
71317254	1002947
71320449	1000379
71322828	1000705
71322834	1000691
71324690	1000683
71325150	1002775
71339886	1000593
71347560	1000422
71347561	1000353
71348989	1002035
71348999	1001921
71355170	1000420
71355232	1001660
71356409	1000639
71358255	1001653
71359598	1000699
71363802	1003646
71364077	1001052
71364155	1000783
71364514	1000396
71364922	1000588
71366207	1001918
71367459	1001384
71367469	1001601
71368135	1002030
71370214	1002034
71370279	1002031
71374276	1001862
71374306	1001390
71377787	1001775
71380485	1001923
71386695	1001389
71390209	1003358
71399562	1001876
71418976	1003716
71444986	1003718
72501439	1003730
84175580	1004042
87583785	1003979
201108473	1002321
201108520	1003503

PART NUMBER	OPTIBELT AP
340433045	1002460
340433109	1000087
340433119	1000095
340433237	1002758
340433238	1000210
340433240	1000212
340433242	1000213
340433251	1000229
340433257	1002779
340433474	1000789
340433476	1000583
340433477	1003469
340433988	1003855
340435126	1001474
344311234	1003849
344311235	1003850
344311237	1003853
344311311	1003918
344311313	1003919
344311322	1002015
344312129	1003851
684121300	1002556
684121325	1002558
684121350	1002560
684121375	1002562
684121400	1003730
684121425	1003733
684121450	1002575
684121475	1002579
684121500	1002582
684121525	1002584
685081730	1002656
685081785	No AP
700705430	1001283
700705503	1001284
700705773	1002776
700708547	1002629
700711852	1001671
700714423	1002866
700715554	1002657
3443111171	1001577
3443111278	1001637
228999M1	1000251
320593M2	1001361
320623M2	1003438
321034M3	1000337
322768M1	1003482
402177M1	1003399
402603M1	1003459
405928M1	1003463
410647M1	1001363
411020M1	1000193
411218M1	1001065
412333M1	1003574
418209M1	1003493
511275M1	1000150
515382M1	1001023
515383M1	1001024
523735M1	1000146

PART NUMBER	OPTIBELT AP
603719M1	1001406
624728M1	1000031
832790M3	1001444
832866M2	1000826
843302M1	1003557
843324M1	1000808
903594M2	1003392
905982M1	1001479
916801M2	1000641
916854M1	1000385
962666M1	1002467
1604055M2	1003484
1604401M1	1000370
1615962M1	1000760
1720674M2	1000221
1730367M1	1000877
1731014M1	1000668
3021251M1	1000142
3036551M1	1003648
3101337M1	1003431
3170530M1	1000841
3170531M1	1000795
3172001M1	1000827
3371438M1	1000846
3373171M2	1003505
4275185M91	1002523
4282444M1	1004195
01145049	1000317
	1004837
038355T1	1000080
038357T1	1000161
039631T1	1003920
053640T1	1001510
053928T1	1000652
0554093.0	1004100
055574	1003516
058147P1	1003367
059105T1	1001996
059106T1	1001499
06154847	1000108
063211T1	1001571
063212T1	1001621
064441T1	1001467
065188T1	1003921
068154T1	1003922
068918T1	1001620
1036940M1	1000876
105654W1	1002005
1175-105-150.00	1001544
1447317M1	1003729
1447784M91	1002545
1483880M1	1000540
1483881M1	1000609
1604464M1	1002056
1614629M91	1002743
1615962M1	1000759
1616714M1	1001485
1616715M1	1001460
1617332M1	1000089

# PART NUMBER

PART NUMBER	OPTIBELT AP
1621182M1	1002265
1628951M1	1003551
1630361M1	1000021
1641945M1	1000189
1669923M1	1000066
1671988M1	1001179
1695146M1	1002573
1700120M1	1000034
1715558M91	1000183
1718508M91	1002750
1730033M91	1000077
1730034M91	1000075
1730366M1	1000872
1730687M1	1003552
1730781M1	1003554
1730782M1	1000771
1730976M1	1000842
1731015M1	1000707
1731023M1	1000722
1810378M91	1000534
1810382M91	1002780
1810543M91	1002781
186976M1	1002551
1876670M1	1000061
195672M1	1000633
200432M1	1000636
218560M91	1003599
226981M1	1001473
3019084M91	1002949
3021192M1	1000145
3021313M3	1000128
3035568M2	1001058
3035569M1	1001055
3036278M1	1002050
3041017M1	1002520
3042011M1	1002310
3042012M1	1002302
3049776M1	1000563
3050742M1	1000651
3052209M1	1002582
3098211M2	1004188
	No AP
3098212M2	1003595
	No AP
3106033M1	1002061
31-1730870	1001119
3173304M1	1000822
3175109M1	1000771
3175160M1	1000844
3193693M2	1002265
3226971M2	1001510
3316647M1	1000709
3371438M1	1000590
3371692M1	1000344
3371800M2	1001465
3372217M1	1002049
3383045M1	1002484
3383691F1	1002526
3386191M1	1002952

PART NUMBER	OPTIBELT AP
3389525M1	1002534
3389542M91	1002954
3435748M1	1002536
3465729M1	1000404
3538921M1	1000120
3581286M1	1002588
3581635M1	1002529
3582951M1	1002537
3582954M1	1002587
3590943M1	1000220
3590944M1	1003398
3616513M1	1002585
3617176M91	1002958
3617178M91	1002916
3617183M1	1002589
3619085M1	1002574
3619357M1	1002921
3619358M91	1002944
3637597M1	1002548
3637598M91	1002946
3637978M91	1002550
3648900M1	1002339
3656765M1	1002354
3700656M1	1002329
3700658M91	1002463
3712531M1	1002528
3712532M1	1002532
3761507M91	1002923
3777379M91	1002958
3777682M1	1002962
3777748M1	1002517
3778975M2	1002516
3780139M1	1002566
3780140M1	1002568
3780141M1	1002571
3780602M1	1002580
3780609M1	1002555
3780610M1	1002556
3780611M1	1002556
3780612M1	1002568
3780613M1	1002565
3780614M1	1002576
3780617M1	1002559
3780645M91	1002963
3780908M91	1002969
3787373M2	1002620
3787792M1	1002623
3809174M1	1002524
3920203M1	1002340
3920419M1	1001275
3920562M1	1001276
3920712M1	1002289
406562M1	1000869
406681M1	1000836
407189M91	1002071
407218M1	1003690
407692M1	1003451
410919M1	1000661
410957M1	1003493

PART NUMBER	OPTIBELT AP
410958M1	1000552
411218M1	1001065
4273187M1	1002656
4273188M1	1002658
4275185M91	1002524
4275545M3	1002613
4276375M1	1002627
5015577M1	1003691
511277M3	1000111
5115483M1	1002529
514806M1	1000094
518125M2	1000099
523733M1	1000095
523735M1	1000146
530669M1	1000096
530756M1	1000147
531316M1	1002089
583824M1	1001354
584850M1	1000223
600P02	1004032
604735M1	1000556
604964M1	1003398
605638M91	1002780
6200242M1	1000590
6200432M1	1001484
6201516M1	1001770
6202555M1	1001815
6202933M1	1002016
6203462M2	1003923
6203660M1	1000587
6203678M1	1000717
6203764M1	1001611
6209374M1	1001638
6209375M1	1000350
6210650M1	1003495
6210826M1	1001632
6210914M1	1001719
6211072M1	1001773
6211078M1	1000329
6211079M1	1001189
6211081M1	1001600
6211082M1	1001971
6211083M1	1001139
6211250M1	1000726
6211508M1	1003924
6212014M1	1003925
6212790M1	1000693
621320M2	1001486
621321M2	1001482
621646M1	1001471
6216726M1	1003836
6216981M1	1002548
6219167M1	1001778
623098M1	1000187
623537M1	1000032
6235815M1	1003926
6235825M1	1003927
6236823M1	1002526
6239971M1	1000560

# PART NUMBER



PART NUMBER	OPTIBELT AP
624728M1	1000031
6263504M1	1003334
6273869M1	1003835
6284282M1	1003508
629004M1	1000488
636208M1	1000490
636276M1	1000491
641696M1	1000192
669452M91	1002783
782835M1	1001470
783539M1	1001481
783907M2	1000235
784789M2	1000643
787237M1	1003520
832882M1	1000323
833857M3	1001476
833865M2	1003665
834061M1	1002423
834110M1	1001480
834174M1	1001462
842413M2	1000227
843810M1	1001184
84416 M1	1000121
87041732C	1004060
901855M1	1000574
906424M1	1000071
916799M1	1000585
916800M2	1000775
916854M1	1000385
960972M1	1002051
962666M1	1002467
969186M1	1002047
AG516558	1000984
AG516861	1000983
AG517279	1000985
E040T07	1004021
GR17880810	1001025
WR10487	1001350
X696.519.400.000	1000089
X696.610.600.000	1000004
X696.611.312.000	1000010
X696.611.611.000	1002440
X696.612.000.000	1002919
X696.612.200.000	1002477
X696.612.313.000	1002741
X696.612.400.000	1002925
X696.612.500.000	1000007
X696.612.600.000	1002926
X696.612.602.000	1002479
X696.612.811.000	1002444
X696.612.913.000	1002445
X696.613.101.000	1002447
X696.613.308.000	1000011
X696.613.501.000	1002930
X696.613.600.000	1000012
X696.613.801.000	1002450
X696.613.901.000	1002469
X696.614.513.000	1002455
X696.614.601.000	1002456

PART NUMBER	OPTIBELT AP
X696.614.700.000	1003363
X696.614.802.000	1002421
X696.614.913.000	1002462
X696.615.002.000	1002923
X696.615.200.000	1002468
X696.615.301.000	1002931
X696.615.401.000	1002471
X696.615.408.000	1000024
X696.615.600.000	1000026
X696.615.601.000	1002924
X696.615.704.000	1002932
X696.616.000.000	1002472
X696.616.102.000	1002441
X696.616.201.000	1002481
X696.616.300.000	1002443
X696.616.600.000	1002489
X696.616.702.000	1002934
X696.616.800.000	1002485
X696.616.913.000	1002474
X696.617.701.000	1002429
X696.617.800.000	1002451
X696.617.900.000	1002473
X696.618.200.000	1000046
X696.619.200.000	1002534
X696.619.413.000	1000060
X696.622.000.000	1000086
X696.622.700.000	1002504
X696.622.800.000	1002503
X696.622.900.000	1002505
X696.623.000.000	1002511
X696.623.200.000	1002514
X696.623.300.000	1002415
X696.623.400.000	1002520
X696.623.600.000	1002529
X696.623.700.000	1002537
X696.623.800.000	1002539
X696.623.900.000	1002543
X696.624.100.000	1002528
X696.624.200.000	1002547
X696.624.300.000	1002541
X696.624.400.000	1002549
X696.624.500.000	1002552
X696.624.800.000	1002561
X696.629.509.000	1000991
X696.631.009.000	1000993
X696.631.409.000	1000994
X696.631.609.000	1000995
X696.633.500.000	1000996
X696.633.800.000	1000209
X696.635.400.000	1000997
X696.635.500.000	1003397
X696.640.500.000	1002501
X696.640.600.000	1002502
X696.642.000.000	1003731
X696.989.501.000	1001131
X697.170.100.000	1001040
X697.171.900.000	1001048
X697.171.901.000	1001047
X697.172.100.000	1001049

PART NUMBER	OPTIBELT AP
X697.173.600.000	1002631
28263409	1004859
6290138M1	1000100
41910400	1000141
3315897M1	1000194
836007765	1000201
6230964M1	1000345
26746970	1000350
26746971	1000434
26749057	1001269
41978600	1001365
833857M5	1001476
6154998	1001719
6159053	1001768
833874M2	1001848
6215259	1002016
685081745	1002658
V685081745	1002658
685081920	1002662
V685081920	1002662
500251D1	1002668
0000855650	1002754
685081660	1003158
V685081660	1003158
685081710	1003162
V685081710	1003162
F716200040020	1003163
685081850	1003177
V685081850	1003177
685081895	1003183
V685081895	1003183
685082300	1003217
V685082300	1003217
685081800	1003813
V685081800	1003813
F718202040010	1003813
500252D1	1003945
6237300M1	1004297
700719689	1004359
71396754	1004364
26746968	1004837
41944700	1004840
6153723	1004632
6153386	1004633
26746998	1004647
685061555	1004861
685081290	1004869
685081315	1004870
F524200040160	1002694
26746958	1002852
1483882M1	1003489
0000056325	1000577
6220987M1	1003503
71398366	1000588
0000055574	1003516
0000856641	1002858
0000856401	1000646
0007855331	1000649
6231843M1	1000650

# PART NUMBER

PART NUMBER	OPTIBELT AP
06155819	1000654
6217977M1	1000676
6230739M1	1000685
048392T1	1000695
0000857219	1000703
0000855007	1000740
XP12472	1000763
71427254	1004476
71335475	1000790
71447314	1004482
0000855791	1000817
26746972	1000825
685102194	1004317
X697.174.000.000	1004337
685121370	1004339
685121530	1003067
685121555	1004341
685121570	1004342
685121610	1004343
71444986	1003718
685121725	1003074
685121765	1004344
685121845	1004345
685121860	1004829
685121880	1004829
685121905	1004687
685121945	1004346
685121965	1004347
685122020	1004348
685122140	1003954
4293007M2	1004350
197-6292	1004387
197-6291	1004388
197-6290	1004389
685141585	1004390
6237301M1	1004281
0000290331	1001051
71374305	No AP
0000765173	1003594
0000765174	1001597
71390199	1001604
0007855349	1001609
6232489M1	1001613
6230741M1	1001616
6289543M1	1003878
6298761M1	1001632
6290856M1	1001638
6289544M1	1001651
71444306	1001657
6231546M1	1004199
71432802	1001664
6268436M1	1001672
700719205	1004852
71462784	1004521
6294242M1	1001679
71462787	1003888
71447401	1004525
71449576	1004527
6231547M1	1001741

PART NUMBER	OPTIBELT AP
71464666	No AP
71442230	1004514
71440999	1004515
71442255	1004517
71448503	No AP
71448508	1001769
6153715	1004547
26746997	1001074
26746996	1001075
700717275	No AP
71432619	No AP
71441902	1004558
71440993	1004560
71390561	1003717
26746995	1001863
1141641	1001865
26732883	No AP
71441879	1004582
71430816	1004590
71440983	No AP
71448515	1004599
71447313	No AP
6154285	1004600
700721267	1004601
6219414M1	1003663
6218984M1	1002004
26746973	1002028
71427343	1004625
71434213	No AP
685061675	1004863
685061725	1004864
685061740	1004865
685061755	No AP
685081680	1003160
V685081680	1003160
056150T1	1002444
684101000	1002453
684101025	1002455
684101050	1002456
684101100	1002459
684101125	1002460
684101150	1002462
056148T1	1002464
684101175	1002465
684101225	1002471
684101238	1004876
684101350	1002483
X696.616.702.010	1002492
069998T1	1002934
069999T1	1002918
6217950M1	1002496
684120825	1002507
684120875	1002512
684120900	1002514
684120918	1002415
684120925	1002515
684120950	1004851
059169R1	1002519
684120975	1002520

PART NUMBER	OPTIBELT AP
684120992	1004773
684121050	1002529
684121075	1002532
684121100	1002534
054607T1	1002534
684121125	1002537
V33279600	1002537
049798T1	1002543
	1004880
684121200	1002547
684121225	1002549
684121250	1002549
	1002551
684121275	1002554
1482511M2	1002558
V33279300	1002558
072727T1	1002560
6900	1002580
026160T1	1002950
056149T1	1002582
684121550	1002586
684121575	1002588
684121600	1002589
684121625	1002593
684121650	1003746
684121675	1002594
10487	1001350
71448483	1001389
71448482	1004047
71368809	No AP
71140808	1004745
71390886	No AP
71390885	No AP
069361T1	1001513
71335788	No AP
6230012M1	1001544
6219396M1	1001545
71376238	No AP
6801631	1004791
V35380300	1002345
D41921801	1004180
6303174M1	1001654
6303185M1	1001830
0007855356	1002756
054315T1	1002487
053650T1	1002932
070460T1	1002492
070461T1	1002494
0006902	1004159
3148053M91	1002961
0006906	1002558
0006907	1002559
489734M2	1002560
6201932M1	1002568
054269T1	1002971
026161T1	1002582
3145135M91	1002956
021078T1	1002598
D41910400	1000141

# PART NUMBER



PART NUMBER	OPTIBELT AP
V836007765	1000201
LA340433238	1000210
LA340433242	1000213
D41985900	1000648
LA340433474	1000789
D41978600	1001365
D41981400	1001437
LA344311322	1002015
D41990014	1002335
V684120918	1002415
V684101000	1002453
V684101025	1002455
V684101050	1002456
V684101100	1002459
V684101125	1002460
V684101150	1002462
V684101175	1002465
V684101225	1002471
V684101350	1002483
V684120825	1002507
V684120875	1002512
V684120900	1002514
V684120925	1002515
V684120975	1002520
V684121050	1002529
V684121075	1002532
V684121100	1002534
V684121125	1002537
V684121200	1002547
V684121225	1002549
V684121250	1002549
	1002551
V684121275	1002554
V684121550	1002586
V684121575	1002588
V684121600	1002589
V684121625	1002593
V684121675	1002594
V685121530	1003067
V685121725	1003074
V684121650	1003746
V685122140	1003954
87041732	1004060
V685102194	1004317
V685121370	1004339
V685121555	1004341
V685121570	1004342
V685121610	1004343
V685121765	1004344
V685121845	1004345
V685121945	1004346
V685121965	1004347
V685122020	1004348
V685141585	1004390
71399514	No AP
X696519400000	1000089
X696610600000	1000004
X696611611000	1002440
X696612000000	1002919

PART NUMBER	OPTIBELT AP
X696612313000	1002741
X696612400000	1002925
X696612500000	1000007
X696612600000	1002926
X696612602000	1002479
X696612811000	1002444
X696613101000	1002447
X696613308000	1000011
X696613501000	1002930
X696613600000	1000012
X696613801000	1002450
X696613901000	1002469
X696614513000	1002455
X696614601000	1002456
X696614700000	1003363
X696614802000	1002421
X696615002000	1002923
X696615200000	1002468
X696615301000	1002931
X696615401000	1002471
X696615408000	1000024
X696615600000	1000026
X696615601000	1002924
X696615704000	1002932
X696616000000	1002472
X696616102000	1002441
X696616201000	1002481
X696616300000	1002443
X696616600000	1002489
X696616702000	1002934
X696616800000	1002485
X696617800000	1002451
X696617900000	1002473
X696618200000	1000046
X696619200000	1002534
X696619413000	1000060
X696622000000	1000086
X696622700000	1002504
X696622800000	1002503
X696622900000	1002505
X696623000000	1002511
X696623200000	1002514
X696623300000	1002415
X696623400000	1002520
X696623600000	1002529
X696623700000	1002537
X696623800000	1002539
X696623900000	1002543
X696624100000	1002528
X696624200000	1002547
X696624300000	1002541
X696624400000	1002549
X696624500000	1002552
X696624800000	1002561
X696629509000	1000991
X696631009000	1000993
X696631409000	1000994
X696631609000	1000995
X696633500000	1000996

PART NUMBER	OPTIBELT AP
X696633800000	1000209
X696635400000	1000997
X696635500000	1003397
X696640500000	1002501
X696640600000	1002502
X697170100000	1001040
X697171900000	1001048
X697171901000	1001047
X697172100000	1001049
X697173600000	1002631
X696.613.313.000	1000011
X696613313000	1000011
650203010870	1003144
651200010220	1002647
X696.612.900.000	1000009
X696.614.602.000	1002456
X696612900000	1000009
X696624600000	1002532
6266289M1	1004489
6268912M1	1004490
6220817M1	1004491
6213293M2	1004492
6248647M1	1004493
71426450	1004501
6289545M1	1004519
6227303M1	1004559
6237294M1	1004561
6220518M1	1004562
6289542M1	1004586
6219415M1	1004592
V35354900	1004607
6232589M1	1004621
6219408M1	1004627
650.623.030.550	1004651
650623030550	1004651
4288688M1	1004687
685121905	1004687
V685121905	1004687
034699T1	1004715
034948T1	1004716
3587701M91	1004719
3587700M1	1004720
021077T1	1004721
6230869M1	1004733
6230019M1	1004734
6275380M1	1004740
6275381M1	1004741
2833904M3	1004744
41990007X	1004764
V684120992	1004773
6627918	1004792
650.203.040.010	1004801
650203040010	1004801
V33099800	1004824
V685121860	1004829
V685121880	1004829
D41944700	1004840
6298767M1	1004847
V684120950	1004851

# PART NUMBER

PART NUMBER	OPTIBELT AP
6272560M1	1004859
V685061555	1004861
V685061675	1004863
V685061725	1004864
V685061740	1004865
V685081290	1004869
V685081315	1004870
207-2949	1004872
V684101238	1004876
069362T1	1004888
1686837M1	No AP
3049010M91	No AP
3371643M1	No AP
3380422M1	No AP
3387555M1	No AP
3714575M1	No AP
3778297M1	No AP
3780607M91	No AP
4273269M1	No AP
0000400875	No AP
230356M4	No AP
233213M1	No AP
238887M2	No AP
240447M3	No AP
410215M1	No AP
410617M1	No AP
6217825M1	No AP
6223463M1	No AP
6228951M1	No AP
6228952M1	No AP
6236843M1	No AP
6240108M1	No AP
6262408M1	No AP
6268248M1	No AP
6268461M1	No AP
6272565M1	No AP
6298212M1	No AP
833858M5	No AP
AG516559	No AP
D41997900	No AP
V685061755	No AP
V685081785	No AP
117029010800	1000118
117510515000	1001544
112366410100	1003992
916201040200	1004340
650633020010	1004678
<b>BISO</b>	
460189	1004083
41981500	1004070
84021591	1004053
84058338	1004054
84449765	1004043
87311867	1004046
87317063	1004047
87330894	1004048
87629601	1004050
87629602	1004051

PART NUMBER	OPTIBELT AP
0554099.1	1004073
10VX00	1000801
10VX00A	1004024
10VX00B	1004023
18 PJ 1244	1004104
600A02B	1003990
600A03	1000766
600A07	1000769
600A09	1000602
600A14	1000575
600A17	1000615
600A750	1000808
600J02	1003984
600J03	1003985
600J07	1000674
600J20	1000756
600J22	1000725
600J31	1003986
600P01	1003392
600P03	1003384
600P04	1004033
600P06	1000196
600P12	1003385
600P90	1004034
9351.0013.00	1000628
9351.0046.00	1000730
9351.0053.00	1000738
9351.0077.00	1000792
9351.0082.00	1000798
9351.0084.00	1003987
9351.0092.00	1003988
9351.0108.00	1000836
9351.0128.00	1003688
9351.0132.00	1003312
9351.0136.00	1003690
9351.0148.00	1004029
9351.0150.00	1002247
9351.0154.00	1002251
9351.0183.00	1003326
9351.0190.00	1001690
9351.0193.00	1001692
9351.0196.00	1004012
9351.0234.00	1000278
9351.0286.00	1001702
9351.0287.00	1003346
9351-0102.00	1003989
93510204.00	1001710
990602570005	1004031
E020T11	1004009
E020T13	1004013
E020T14	1004005
E020T15	1003888
E020T16	1003884
T040H01	1004006
990601371026	1000735
990606582526	1001714
<b>BIZON</b>	
825117	1004147

PART NUMBER	OPTIBELT AP
9515075	1001428
9515076	1001416
9818873	1003662
84021588	1000083
84026042	1001621
84996133	1001657
51101131525	1000123
51101131570	1000126
51101132800	1000158
51101171335	1000218
51101171375	1000221
51101171750	1003418
51101171981	1000267
51101172438	1004834
51101222525	1000628
51101255970	1000930
51101321750	1001413
51101622375	1001545
51102173550	1001651
51103172120	1001811
51103172380	1001827
51103172650	1001840
51103173062	1003637
51103173220	1003638
51104172270	1001952
51104173940	1003666
51651222360	1000615
1374-310-409	1001840
89515075	1001428
89515076	1001416
89818873	1003662
<b>CASE INTL. HARVESTER</b>	
21486	1002441
66232	1000690
130013	1002975
142273	1000016
230056	1003232
230077	1001489
230078	1001509
270174	1000030
314115	1001494
321559	1001512
330715	1000726
334065	1001403
350236	1003640
356024	1001489
356025	1001525
381236	1002944
381237	1002567
387469	1000700
388280	1001410
393519	1002593
421173	1002556
422731	1000696
424563	1001765
427456	1003351
431784	1000328
432642	1003746



# PART NUMBER



PART NUMBER	OPTIBELT AP
433746	1000405
433747	1003252
434044	1003669
434222	1001635
437033	1002878
439129	1003586
440780	No AP
444045	1002554
446969	1001489
452022	1002595
456216	1002575
457643	1000159
603720	1003584
717699	1003882
743877	1001980
748003	1002974
753053	1000706
754165	1002415
754388	1003341
754389	1003338
755808	1001487
797475	1000998
825013	1001562
857938	No AP
861731	1003978
900611	1002532
904027	1001741
904029	1001718
904031	1001724
904038	1001729
913524	1000412
921330	1000785
1301131	1002598
3142286	1000005
3142287	1000008
3143002	1000021
3781694	1003431
3795185	1000702
6500261	1002944
8602680	1002643
9501182	1002579
9501863	1002960
9502828	1001053
9506748	1002510
9508557	1002945
9508558	1002946
9513984	1003345
9514310	1000152
9575059	1002571
9575153	1002879
9593418	1000813
9593440	1000816
9593464	1002031
9800111	1000713
9814069	1001557
9817374	1001876
9818705	1000079
9819676	1000672
9829162	No AP

PART NUMBER	OPTIBELT AP
9831571	1003668
9833619	1003137
9833888	No AP
9835120	1001781
9835683	1002667
9835815	1003733
9837412	1000573
9839375	1000774
9850080	1004079
31295188	1001872
31301147	1001704
31302068	1002256
31302076	1002670
31310695	1003051
31314408	1002674
31317917	1002808
31318645	1002018
31343437	1001574
31360374	1003037
80046914	1003508
80159837	1004261
80354115	1001494
80392361	1003661
80396749	1003467
80433747	1003252
80437607	No AP
80443635	1002460
80446969	1001489
80446970	1001496
80449701	1000426
80452022	1002595
80452023	1003776
80453267	1003311
80516776	1000349
80531558	1003509
80543226	1004377
80565498	1002132
80603720	1001405
80727852	1003508
80746889	1000735
80746890	1000744
80746891	1000798
80746893	1001647
80746894	1001695
80749144	1000559
80749145	1002822
80754423	1000660
80851792	1001180
80913524	1000412
80921330	1000785
80980001	No AP
82010895	1002619
82012177	1002619
82850752	1002639
84000190	1001694
84001336	1001776
84002709	1000583
84005357	1002758
84005861	1002638

PART NUMBER	OPTIBELT AP
84005971	1000826
84005972	1000829
84007006	1001766
84007677	1001783
84012390	1002026
84017753	1003038
84018998	1000831
84019041	1000730
84019385	1000834
84021589	1004052
84023913	1002678
84024926	1003366
84026668	1000667
84026762	1003001
84026892	1000571
84036578	1002929
84036579	1001165
84038109	1000618
84041069	1001711
84041070	1001707
84041094	1001712
84041095	1001708
84043106	1002823
84043107	1002928
84045018	1000712
84045444	1000311
84045751	1002602
84045959	1000672
84054417	1001007
84056914	1002927
84057609	1000294
84057610	1002720
84058063	No AP
84058255	1000650
84073615	1002824
84074272	1002659
84074273	1002145
84075053	1002691
84075677	1001342
84075683	1002172
84078581	No AP
84215838	1002689
84226318	1000674
84254495	1001837
84262973	1003935
84284322	1003936
84284468	1003937
84286546	1003938
84287970	1003939
84342685	1003977
84342686	1003976
84346830	1003940
84373502	1003200
84376536	1001603
84381274	1004186
84384813	No AP
84435248	1001187
84440188	1000806
84449662	1003355

# PART NUMBER

PART NUMBER	OPTIBELT AP
84531713	1003719
84814035	1001188
84817621	1000620
84817622	1000750
84817624	1003341
84817625	1000321
84817633	1003346
84817634	1002026
84817637	1003617
84817638	1003807
84817640	No AP
84996134	1001715
84999531	1001168
86514520	1000232
86517680	1001853
86566286	1001627
86566606	1001978
86595191	1000345
86596143	No AP
86627791	1001942
86627796	1003356
86988710	1001616
87061270	1000667
87061591	1000642
87282305	1004182
87283139	1001373
87301455	1004898
87309958	1002664
87316555	1002647
87316556	1002636
87330903	1001616
87366024	1003698
87366407	1003971
87402830	1002666
87402831	1003792
87437226	1003972
87441267	1003795
87441268	1002671
87476486	1004065
87476487	1004064
87564450	1001620
87628477	1003356
87642957	1000693
87699094	1003941
87755884	1003195
87802822	1002664
89505865	1001654
89506463	1001690
89507997	1000271
89509459	1000163
89510091	1003431
89513440	1002138
89515166	1002120
89515167	1002865
89515172	1000546
89515713	1002825
89516212	1001206
89811480	1003616
89811963	1001695

PART NUMBER	OPTIBELT AP
89813594	1000399
89817249	No AP
89817439	1000593
89817548	1000739
89819506	1001693
89819507	1001699
89819509	1001692
89831693	1002445
89831694	1002448
89831695	1002449
89831696	1002450
89831697	1002454
89831698	1002452
89831699	1002456
89831700	1002457
89831701	1002460
89831702	1002462
89831703	1002465
89831704	1002468
89831705	1002471
89831706	1002473
89831707	1002475
89831708	1002478
89831709	1002933
89831710	1002483
89831711	1002920
89831712	1002922
89831713	1002488
89831714	1002490
89831715	1002492
89831716	1002494
89831717	1002495
89831718	1002496
89831719	1002497
89831720	1002499
89831721	1002461
89831722	1002505
89831723	1002507
89831724	1002508
89831725	1002512
89831726	1002514
89831727	1002515
89831728	1002521
89831729	1002534
89831730	1002537
89831731	1002539
89831732	1002543
89831733	1002547
89831734	1002549
89831735	1002551
89831736	1002554
89831737	1002556
89831738	1002558
89831739	1002560
89831740	1002562
89831741	1002567
89831742	1002571
89831743	1002575
89831744	1002579

PART NUMBER	OPTIBELT AP
89831745	1002582
89831746	1002584
89831747	1002588
89831748	1002593
89831749	1002594
89831750	1002595
89831751	1002598
89831752	1002599
89833888	1004470
89835010	1000726
89835047	1000827
89850532	1002147
209553078	1002124
340433153	1000127
419375000	1002773
700707578	No AP
700707586	No AP
700711518	No AP
770000722	1001629
770002330	1001721
875556830	1004157
4031832698	1003947
4032804396	1003948
4032807784	1003949
4131775305	1001202
4131781578	1003036
4221613143	1003560
4221668157	No AP
4240053761	1003006
4247047693	1000000
4250121764	1003650
4250121860	1000998
4250121877	1001202
4250121885	1001205
4250129730	1002238
4250129747	1003314
4250129755	1003687
4254138496	1002349
4254138824	1003685
4254138832	1002185
4254138840	1002161
4254138857	1002124
4255643332	1000623
4260699985	1001901
4260699993	1001516
4260700007	1002166
4260700015	1002135
4260700023	1003007
4260700031	1002990
4260703838	1002280
4260703846	1002263
4260703926	1003563
4264715364	1000634
4270717737	1001944
4270722236	1003361
4270722244	1001513
4270722252	1002400
4270722517	1003052
9911860435	1000906

# PART NUMBER



PART NUMBER	OPTIBELT AP
9911860628	1002881
9911860958	1001178
9911861477	1002065
9911861493	1002127
9911861516	1002216
9911861524	1002218
9911861540	1002223
9911861612	1002148
9911861645	1002076
9911861717	1003009
9911861725	1002110
9911861862	1002237
9911861901	1002228
9911861918	1002991
9911861926	1003689
9911862043	1002992
14010060002	1003695
51101256000	1000931
51102171670	1001556
51102174610	1001678
51651131427	1003373
51651132765	1000156
51651170965	1003383
51651170975	1003384
51651171700	1000243
51651171930	1003426
51651172413	1000300
51651173861	1000377
51651221725	1000561
51651221981	1000584
51651222413	1000620
51651222650	1003525
51651222800	1000659
51651223505	1000721
51651255246	1000927
51651321480	1001408
51651453200	1001490
51651502130	1001508
51652131450	1000120
51652171372	1003336
51652171800	1001560
51652172200	1001585
51652172500	1001602
51652174225	1001668
51652174350	1003614
51652175000	1001690
51653173180	1001859
51653173762	1003649
51654172420	1001956
3228287 R91	1002945
01100788	1002052
01101723	1000243
01101811	1001579
01103821	1002826
01104002	1003400
01108473	1003498
01108520	1003503
01109023	1002322
01109080	1002406

PART NUMBER	OPTIBELT AP
01111067	1002039
01111227	1002219
01111661	1002391
01111678	1003693
01111717	1002396
01111725	1002161
01111766	1000179
01111887	1002213
01111895	1003036
01112277	1003039
01112605	1003011
01113116	1001626
01113501	1001570
01113550	1002153
01113864	1002166
01113872	1000179
01113880	1004083
01113897	1000178
01113928	1002344
01113950	1002123
01145629	1004102
01169686	1002209
01169694	1002191
01170132	1001639
020476355	1002148
020953053	1002185
020953061	1002161
021189838	1000634
021206287	1002143
021365202	1003609
04-113516	1003577
04-113518	1001256
04-113598	1001946
04-114742	1003579
04-119434	1002025
04-122838	1001255
04-133180	1001232
060007646	1003007
060038666	1002280
060067605	1001649
060067638	1002135
060067646	1003780
060067654	1002990
060143490	1002198
060143505	1003003
060178276	1001622
060187034	1002257
060187276	1001622
060187284	1000714
060190778	1000688
060190786	1000637
060191762	1003671
060206971	1002993
060206988	1000041
060500044	1002747
060500108	1002347
060500116	1002352
060506933	1002409
060519150	1001676

PART NUMBER	OPTIBELT AP
061009082	1002202
061009396	1003010
061009402	1003005
061015851	1003012
061017105	1002282
061020986	1001647
061029584	1002264
061033443	1002151
061036454	1001628
061067790	1000371
061068951	1001659
061068976	1003003
061068984	1002390
061068992	1003051
061069028	1002201
061069036	1002389
0616355	1000662
082.383/28	1002560
082.383/42	1002961
10VX00C	1004025
1113096X1	1001771
1113097C2	1001144
123305A1	1000432
123306A1	1002307
123307A1	1002309
124572A1	1001599
124573A1	1001600
1250587C1	1003476
1308489C2	1003573
131403C1	1003474
1315074C1	1001147
1315266C1	1001620
1321564C1	1002316
1321565C1	1002320
1325050C1	1000748
1330311C1	1000247
1347157C1	1001610
1347160C1	1001625
1347358C1	1001604
1347387C1	1001602
1407035R1	1002790
1407123R1	1001418
1408761R1	1000372
1408840R1	1001369
1410106R1	1001113
1410279R1	1003531
1410462R1	1001095
1413C060017	1000068
1541569C1	1003472
1541700C1	1001600
1541702C1	1001145
1609B130009	1000015
16131DA	1000533
162000060007(1)	1003739
164550R2	1000102
178019R1	1000625
1806189C1	1002529
181012C1	1001595
181055C1	1001374

# PART NUMBER

PART NUMBER	OPTIBELT AP
181055C11	1001374
182819C1	1000742
182945C1	1000737
183049C1	1001380
186509C2	1001379
188213C1	1000692
188213C3	1000692
191241C3	1001142
191244C1	1001879
191288C2	1000614
191290C1	1000708
191291C1	1000723
191305C1	1000654
192738C1	1003473
194528C2	1003471
195396C2	1001417
196371C1	1000423
1966512C1	1002479
1966513C1	1002408
1970116C2	1000625
197411C1	1000702
1979606C2	1003342
1989217C1	1000728
214522C1	1004125
235414A1	1002515
243372A1	1002650
243373A1	1002653
244420A3	1001531
244422A1	1001533
244422A3	1001532
244423A3	1001534
247426A1	1004061
247428A1	1003917
280210C2	1000115
288648A1	1003044
299659A1	1002481
301146A1	1003931
303416R1	1000059
3043167R1	1002571
3050382R1	1000023
3055525R1	1002560
3055526R1	1000072
3055715R91	1002556
3060802R2	1000068
3061786R2	1002314
3068879R1	1000053
3068901R1	1002525
3069379R1	1000094
3113342R1	1000072
3119750R1	1002446
31275207N1	1000386
31275280N1	1002441
3129139R1	1002588
3129140R1	1002586
31302068	1002256
31310695	1003051
3131095	1003051
31323185	1000388
3136257R1	1000062

PART NUMBER	OPTIBELT AP
3136421R1	1002950
3136663R1	1000068
3139157R91	1002590
31400010	1000072
3142280	1000010
3142541	1000055
3142558	1000066
3144098R91	1002975
3144678R1	1002558
3155068R1	1001446
3155127R1	1001091
3155178R1	1000749
3156215R1	1001463
3157009R1	1001478
3157094R1	1001117
3157600R1	1001371
3157738R2	1001115
3157739R1	1002828
3157741R1	1001098
3157994R1	1003542
3158242R1	1001477
3158455R1	1000904
3158811R1	1001370
3167149R1	1001760
3167361R2	1000637
3167489R1	1004101
3167653R2	1001999
3167797R1	1002882
3170210R1	1000686
3171057R2	1000130
3172232R1	1000228
3172275R1	1001366
3172404R1	1000309
3173115R1	1000914
3173164R1	1002883
3173480R1	1000913
3173717R1	1000725
3173726R1	1001889
3175036R2	1001101
3175078R1	1001885
3175110R1	1001504
3175336R1	1000684
3175457R1	1003429
3175578R1	1002094
3176321R1	1001367
3176558R1	1002994
317904A1	1004097
3218043R1	1002537
3218802R1	1000078
3218951R1	1002560
3218952R1	1002571
3228131R1	1002543
3228274R1	1002551
3228279R1	1002547
3228282R1	1002534
3228287R1	1002945
3228287R91	1002945
3228641R1	1002956
325289A1	1003973

PART NUMBER	OPTIBELT AP
3522468M3	1002519
358213R1	1000084
380041A1	1001143
393750A1	1001146
393751A1	1001144
396829R1	1003475
400427A1	1001216
402368A1	1001169
413159A1	1001535
4240053712	1003012
4250129755	1003687
4254138824	1003685
4254138840	1002161
4260700015	1002135
440498A3	1004116
4990/20555	1001217
58622R1	1000421
599060R1	1001411
59969C91	1003957
600 J 04	1004037
600A06	1004001
600A10	1003994
600A12	1003996
600A701	1004003
600A715	1004002
600A77	1003997
600J06	1004038
600J09	1004039
600P05	1004036
600P09	1004035
6100645M1	1002284
6102366M1	1002520
61521R1	1003416
662213R1	1000541
674965R1	1000633
683548C91	1002303
69490DA	1000533
712216R1	1003370
714241R1	1000112
716404R1	1000024
716415R1	1002473
716417R1	1002478
739734R1	1000992
756232R1	1000086
756237R1	1000188
758866R1	1000110
760285R1	1002297
762861R1	1002265
764956R1	1000112
767564R1	1001001
767585R91	1002081
768220R91	1002081
769482R1	1002043
769543R91	1000191
769830R2	1003539
790522R1	1000578
793051R2	1000988
793417R2	1000741
84766C1	1002424

# PART NUMBER



PART NUMBER	OPTIBELT AP
84766X1	1002521
874097C1	1000051
9351.0039.00	1003995
9351.0047.00	1004040
9351.0055.00	1004041
9351.0174.00	1001630
9351.0179.00	1004007
9351.0274.00	1001743
97-018167	1000017
98-024334	1001580
98-026090	1001810
98-027803	1001939
98-028535	1001249
98-029076	1001619
98-029103	1001515
98-031256	1001967
98-032070	1001830
98-036087	1001829
98-036261	1001553
98-039673	1001960
98-039691	1002829
98-039777	1001234
98-039778	1001260
98-039783	1001808
98-039925	1002599
98-041408	1001248
98-041788	1001910
98-042220	1001813
98-042446	1002954
98-043793	1001989
98-045851	1002931
98-045896	1001233
98-046005	1002995
98-046076	1002345
98-046372	1002349
9817439	1000593
989271C1	1000728
98927C	1000728
99.060663-1005	1001721
99.060738-3023	1001883
99.060739-8023	1001890
A138759	1002266
A169970	1002521
A184652	1002524
A938768	1002452
AP706228207	1002097
B506233	1001378
B506234	1000648
B506235	1000693
B506236	1003406
B506237	1003455
B506238	1003426
B506239	1000295
B938746	1002487
C338723	1002485
C938770	1002996
CQ13837	1004101
DF069791	1001164
DF070542	1000683

PART NUMBER	OPTIBELT AP
DF091572	1000685
E020T12	1004014
E040T09	1004020
E128625	1002364
E84994	1002456
G138788	1003043
G38715	1003400
H938752	1002478
H938775	1002127
J38717	1002023
J911557	1002645
J911559	1002649
J911562	1004155
J911567	1003812
J911572	1003140
K138722	1002885
K306655	1000063
K307429	1002525
K308448	1002551
K311714	1002476
K38718	1000118
K68073	1002465
K903050	1002464
K912196	1002458
K913631	1000014
K938731	1003778
K952514	1002422
L38742	1002884
M138747	1000017
MGP1112	1000102
N38744	1002887
N938757	1002048
ND 9050	1002096
ND 9240	1003673
ND-9003	1002088
ND-9036	1003674
ND-9073	1002095
ND-9092	1002197
ND-9317	1002092
ND-9359	1003681
ND-9471	1003680
ND-9674	1000358
P138703	1003397
P38745	1002886
P40058	1001493
P938712	1000194
Q138796	1002044
Q938713	1000195
Q938736	1000056
R138705	1002748
R138797	1002045
R938760	1002082
S438718	1000050
S619146	1001198
S938738	1002483
S938761	1002362
T040H02-A	1004016
T38726	1000054
T938762	1002941

PART NUMBER	OPTIBELT AP
U 938740	1002462
V938741	1002475
V938764	1002925
W938719	1003365
W938742	1002482
X938743	1002492
Z20459	1003583
Z20562	1000753
Z20703	1000679
Z20743	1003505
Z21254	1003372
Z21400	1003496
Z21500	1001103
Z21501	1001102
Z22208	1003720
Z938744	1002457
Z938767	1003006
87491779	1004252
5095203	1002460
4796327	1002461
5154152	1002512
47137503	1002923
98473705	1002467
4796328	1002942
87643267	1002942
500369112	1002465
86013678	1004259
5140009	1002455
51400100	1002457
5186233	1004255
5094418	1004254
99466943	1004256
500386112	1004256
50404925	1004257
84257945	1003189
842373502	1003200
87282333	1003244
82021010	1004260
82007330	1004258
81718146	1000055
73180336	1000060
87518813	1000103
1374-310-400	1000220
84455758	1000265
516776	1000349
589622R1	1000421
20471086	1001000
1113390	1001005
1114295	1001177
20797483	1001202
4221668181	1001204
20797491	1001205
60183586	1001211
72023391	1001220
1170036	1001230
1169983	1001231
61068943	1001241
61068927	1001246
84148387	1001249

# PART NUMBER

PART NUMBER	OPTIBELT AP
1113831	1001259
61068968	1001308
1170204	1001310
1170003	1001313
72048753	1001317
1170181	1001318
1169991	1001319
1170116	1001322
1170124	1001323
60121284	1001513
1170140	1001710
1114576	1001729
770001008	1001742
1170044	1001797
1170060	1001798
60203060	1001863
61068935	1001866
60068286	1001869
60186515	1001883
60038063	1001892
60520763	1001894
770000980	1001894
61020978	1001900
60067590	1001901
1169428	1001938
60124334	1001944
1170028	1001993
1170011	1001997
61004680	1002002
61063633	1002010
60010	1002470
600101	1002471
3140085	1002475
600021	1002495
3145900	1002506
3142590	1002507
602211	1002531
3140058	1002534
3140006	1002544
130071	1002561
1113936	1002567
3140053	1002567
130012	1002571
130072	1002595
84397971	1002644
2855970	1002651
J911580	1002657
3289224	1002658
1170157	1002674
87739437	1002811
378989	1002821
60518004	1002978
3140109	1002986
87415774	1003126
85826230	1003129
87630521	1003132
86982450	1003132
J925953	1003132
J911558	1003133

PART NUMBER	OPTIBELT AP
3288922	1003138
A77938	1003140
4899178	1003141
J911566	1003152
2853208	1003158
2856151	1003162
87397416	1003165
3289279	1003170
84590653	1003170
87354138	1003171
873541380	1003171
3289481	1003176
3289593	1003183
3289604	1003183
3289648	1003186
3288867	1003190
3290158	1003191
3289768	1003195
84423385	1003240
2976405	1003364
BR11018	1003364
294462A1	1003369
610521R1	1003416
446971	1003470
1113985	1003582
1114568	1003623
20797305	1003650
1300721	1003747
3289078	1003749
87519458	1003816
1112638	1003948
3288999	1004095
87683178	1004115
3288812	1004155
219498	1004696
87656225	1004357
1374-310-418	1004360
87641387	1004369
87673234	1004373
86514512	1004374
87758085	1004376
87653464	1004383
47413433	1004438
47406268	1004391
84455757	1004833
677419	1004402
87572660	1004406
84194650	No AP
709998	1004413
84452723	1004836
84180490	1004425
1374-390-255	1004428
84172256	1004444
47414501	1004640
274224	1004646
84449233	1004648
84449232	1004649
84448759	1004650
84511734	1004652

PART NUMBER	OPTIBELT AP
84296393	1004653
84449861	1004654
47131754	1004685
86011009	1004690
84457069	1004698
84458482	1004669
178623	1004701
86629764	1004414
326298	1003489
86633896	1000607
1374-310-425	1000615
178019C1	1000625
186347	1003809
754423	1000660
87027209	1000671
84320459	1000671
47419045	1000691
00422731	1000696
84256364	1004466
333958	1000715
87528805	1000730
00921330	1000785
756900	1004477
87543560	No AP
1374-310-403	1000931
84137560	No AP
84299873	1004310
84238513	1003718
87346514	1004497
84139175	1004498
87393905	1001558
84411381	1001560
84513766	1001560
8520042	1004500
87564452	1001616
87564549	1001616
84171789	1004314
84256369	1004850
904011	1001629
9351017400	1001630
84175581	1001636
84137965	1004511
84533502	1004006
84311543	1004006
87031779	1004127
84168012	1004128
84286835	1004520
1374-390-129	1003615
87368902	1001680
84352807	1001685
746894	1001695
87628478	1003618
86547070	1001713
84274885	1004533
87664231	No AP
87671748	1004532
84191907	1001767
84192753	1004546
87375325	1004548

# PART NUMBER



PART NUMBER	OPTIBELT AP
84472848	No AP
1374-310-407	1001811
84514757	1001838
1374-390-157	1001840
87549556	1001841
87721960	No AP
84582506	1004575
84254480	1001865
47415905	1004577
447031	1001872
84188121	1003643
87747431	1001876
87583899	1001877
84298895	1004581
84298887	1004583
84352808	1004286
87741240	1001914
87527868	1004591
84398997	No AP
84589013	No AP
84589012	No AP
851792	1001180
84449048	1004602
84459680	1004605
86627797	No AP
86627809	1004608
86627808	1004609
84012562	1004612
87030923	1004613
323646	1001949
86582818	1004615
87012453	1001969
922911	1002004
84582509	1004623
84394081	1004503
84522809	No AP
84565781	No AP
84175582	No AP
84562967	No AP
84565774	No AP
87664226	No AP
87671939	1004889
84356659	1004628
84127377	1004629
84223612	1002627
84518497	1002627
80851791	1004631
87656270	1004659
3288757	1004871
3288768	1004871
86514616	1004723
86514615	1002506
83949803	1002506
84271496	1002506
87354141	1004851
87567471	1004773
84243629	1002521
2929681	1002528
87373569	1002530

PART NUMBER	OPTIBELT AP
86516699	1004879
86514611	1002539
938787	1002543
84185053	1002543
81549846	1002546
4760486	1004712
81718144	1002549
87429954	1002552
99466947	1002555
84185033	1002556
60517261	1003773
60517253	1002560
81845565	1003728
C9NN-10C318-B	1002565
9604339	1002567
87800129	1002569
84240788	1002971
1791046	1002582
84449518	1003741
87526139	1002589
87526140	1002590
87671290	1004718
87671291	1004717
918062	1004630
87346859	1002601
87374574	1004722
86634492	1001350
87655953	No AP
84188501	No AP
1374-310-379	1001408
1374-310-381	1001408
1374-310-420	1001413
84993224	1001488
1374-310-380	1001490
84981849	1003586
1374-310-421	1001508
86610860	No AP
84493480	No AP
86518569	No AP
87540195	No AP
84493479	No AP
84262995	No AP
8403693	1002050
8403632	1003914
1725666	1004758
1590486	1004760
87325327	1004793
87456836	1003044
84365709	1004826
2213342	1004838
2929932	1004818
3012326	1004819
2900435	1002343
2928981	1004820
87531466	1004692
159837	1004261
80347469	1000700
84455765	1004833
1966513C2	1002408

PART NUMBER	OPTIBELT AP
84455766	1000265
84452979	1004836
873541410	1004851
873735690	1002530
399058	1004630
87528118	1004692
80230056	1003232
500380059	1003718
011170198	1003611
84398996	1001823
84398998	1004574
47441074	1004286
89831571	1003668
835683	1002667
446970	1001496
84042180	No AP
9911861364	No AP
4032808262	1001828
4131775313	1002213
4131781055	1001557
1315265C1	1001602
190003142503	1000044
A78022	1003195
851791	1004631
80230073	1000904
190003142304	1000006
190003142284	1000007
190003142287	1000008
190003142293	1000009
190003142291	1000011
190003142332	1000012
190003142295	1000013
190003143470	1000017
190003141018	1000023
190003142313	1000025
190003142334	1000028
139900270174	1000030
190003142516	1000047
190003142527	1000048
190003142521	1000049
190003142504	1000050
190003140081	1000051
190003142543	1000058
190003142557	1000065
1374-390-275	1004488
241895A2	1004704
244420A4	1004746
244422A4	1004747
244423A4	1004748
413159A2	1004749
060206963	1004750
159639A1	1004802
289198A1	1004804
289199A1	1004805
1374-310-401	1004834
379461A1	1004851
S80928	1004879
99.060268-5000	1004887
J911587	No AP

# PART NUMBER

PART NUMBER	OPTIBELT AP
(87690710)	No AP
003795185	No AP
01101908	No AP
01103493	No AP
01109312	No AP
1316573C2	No AP
1329161C1	No AP
244423A5	No AP
301111A1	No AP
4102/50063	No AP
452864R1	No AP
700714140	No AP
99.060226-5000	No AP
N938734	No AP
Z22648	No AP
190003142508	1000045
190003142532	1000054
190003140037	1000062
190003142558	1000067
139900270270	1000076
190003140080	1000185
190003142710	1000194
190003142718	1000206
190003142802	1000492
139900270236	1001172
139900270478	1001218
139900270408	1002074
190003149999	1002343
190003140054	1002442
190003142278	1002443
190003142275	1002447
190003140030	1002451
190003140029	1002453
130800060010	1002471
140100060001	1002475
190003140007	1002475
190003140041	1002478
1411000600141	1002478
190003142340	1002481
190003140013	1002483
190003140078	1002512
162000130046	1002513
1620001300461	1002513
190003140084	1002514
190003142523	1002515
162000131001	1002521
190003140073	1002529
190003140006	1002547
130100130041	1002551
1301001300411	1002551
190003140047	1002554
190003140062	1002556
190003142525	1002558
130100130071	1002560
132000130021	1002560
1420000600111	1002564
139900130003	1002567
1399001300031	1002567
162000060006	1002569

PART NUMBER	OPTIBELT AP
1420000600121	1002569
1620000600061	1002569
132000060012	1002572
1320000600121	1002572
130100130112	1002575
190003140020	1002594
130100130072	1002595
130100130113	1002598
190003142325	1002742
190003142526	1002744
190003142350	1002918
190003142358	1002922
140100060002	1002924
190003140032	1002924
130100060018	1002936
190003142270	1002937
190003142272	1002938
190003142273	1002939
190003142357	1002940
190003140053	1002944
142000060001	1002973
142000060011	1002977
190003140035	1002979
142000060012	1002980
190003140039	1002981
190003140064	1002982
190003140083	1002983
190003142590	1002984
190003142290	1003321
190003142309	1003362
161200090098	1003364
190003140079	1003365
130100060017	1003696
132000130020	1003699
162000130004	1003701
1620001300041	1003701
162000130007	1003703
1620001300071	1003703
142000130004	1003704
1420001300041	1003704
142000130005	1003705
1420001300051	1003705
130300060002	1003714
1303000600021	1003715
1320001300211	1003726
1401001301321	1003728
162000060001	1003733
162000060005	1003734
1620000600051	1003734
162000130003	1003736
1620001300031	1003737
162000060007	1003739
1620000600071	1003739
140100130131	1003745
1401001301311	1003745
1401000600021	1003768
1301000600181	1003769
1620000600011	1003774
1420000600011	1003775

PART NUMBER	OPTIBELT AP
1320001300201	1003777
1620001300741	1004773
<b>CHALLENGER</b>	
049880T1	1002562
3386214M1	1002542
3389525M1	1002534
3617180M91	1002430
3619084M91	1002577
3777748M2	1002519
3779379M91	1002571
3780138M91	1002963
3780606M91	1002965
3780608M91	1002578
3789028M1	1002630
3808730M1	1002963
3809174M1	1002524
3809175M1	1002546
3815255M2	1002567
3817582M1	1002944
4271806M1	1002624
4273187M1	1002656
4273188M1	1002658
4273270M1	1002628
4274241M1	1002628
4274692M91	1002971
4275545M3	1002613
4278354M91	1002958
5016260M1	1002524
3815255M1	1002567
4273269M1	1002627
V32889500	1002328
072729T1	1002919
500685D1	1004872
<b>CLAAS</b>	
7700035746	1001043
7700037114	1003744
7700037116	1003745
7700043752	1001334
7700043753	1002678
7700048822	1001335
7700050644	1003245
7700050889	1001336
7700057145	1001337
7700059170	1003134
7700060521	1003782
7700062253	1003135
7700062256	1003195
7700062257	1003192
7700062268	1003140
7700063621	1003807
7700066453	1003217
7700066699	1003196
7700066725	1000990
7700066735	1003975
008952.1	1000487
020344.0	1000369
020345.0	1001667



# PART NUMBER



PART NUMBER	OPTIBELT AP
020600.0	1001817
020601.0	1000338
050090.0	1000528
051689.0	1000368
052393.1	1000122
055292.0	1000240
0554171.0	1004087
055772.0	1000352
060162.0	1000481
060239.1	1000484
060304.1	1002250
060305.0	1002249
060306.2	1000723
060306.4	1000723
060916.0	1002253
060949.1	1000863
060954.0	1000865
061204.0	1000884
061213.0	1000860
061214.0	1000868
061252.0	1000875
061253.1	1000873
061353.1	1000870
061360.0	1000870
061361.0	1000861
061700.0	1003356
061700.1	1003356
061701.2	1000790
0617309.0	1000953
0617309.1	1000954
061872.0	1002867
061878.0	1000824
061902.0	1000851
062043.0	1000843
062294.0	1001351
0628964.1	1002687
063285.0	1001245
063309.0	1002003
063940.0	1000580
064168.2	1003635
064874.0	1000568
066034.0	1000302
0660504.0	1001939
067745.0	1001271
067746.0	1001315
067747.1	1001325
067789.0	1001292
068752.0	1000369
068752.1	1000369
068786.0	1000362
069925.0	1000285
070052.0	1003393
070310.1	1000380
070952.2	1001264
070953.1	1002020
072110.0	1001182
073199.0	1002004
073201.0	1002004
073202.1	1002012

PART NUMBER	OPTIBELT AP
073203.0	1001810
073204.0	1001183
074771.2	1001267
074803.2	1001266
076401.0	1001324
076403.1	1001186
077276.0	1000177
077400.0	1000282
077401.0	1000283
077796.0	1001314
077797.0	1001270
081648.0	1001326
083615.0	1001330
083668.1	1001329
090255.0	1001293
090256.0	1001295
090256.1	1001296
094046.2	1002777
103735.0	1002382
104098.1	1003675
104237.1	1003002
104497.0	1003682
104914.0	1003491
104990.0	1000561
105580.0	1002382
105603.0	1002377
105860.1	1003442
123306A1	1002307
133523.0	1002551
133528.0	1002560
133549.1	1002973
133630.1	1002961
133635.1	1002958
133640.0	1003746
133641.0	1002596
133642.0	1003772
145265.0	1002053
146890.0	1000097
147217.0	1002549
147228.1	1002283
147233.1	1002945
176432.1	1001685
176440.1	1001636
176442.1	1003641
176474.0	1001236
176475.0	1001289
176542.1	1001936
176543.1	1001793
176544.0	1002299
181501.0	1001873
211148.1	1002114
211240.0	1001059
212759.0	1000801
233525.0	1002141
233839.2	1003758
233843.1	1000237
233943.1	1002786
247430A1	1004062
261545.0	1001328

PART NUMBER	OPTIBELT AP
310939.0	1002563
319904A1	1004063
349065.0	1002050
350340.0	1002661
350462.0	1001680
350463.0	1001665
350517.0	1000793
352371.1	1001982
352403.0	1001253
	No AP
353706.0	1002640
355658.0	1001672
355696.0	1004835
495067.0	1001618
495067.1	1001615
500273.1	1003564
500863.0	1000902
500867.0	1003567
501771.0	1000944
501802.0	1003408
501903.0	1000246
501925.0	1003449
503459.0	1000383
503969.0	1000956
505022.0	1003443
505112.0	1003437
505113.1	1003461
505143.0	1000513
505143.1	1000513
506023.0	1000928
506671.2	1000506
506792.1	1000916
506880.0	1000901
506940.0	1000934
507020.0	1002788
507317.1	1002868
507508.0	1003753
507626.0	1003548
507723.0	1000203
507908.0	1000204
509035.1	1000430
509206.0	1000519
509435.0	1000403
512087.0	1002588
528305.0	1002128
532011.1	1003396
538714.0	1003403
544032.0	1003843
544048.0	1001933
544049.0	1001939
544049.1	1001561
544083.0	1001968
544114.0	1001846
544114.1	1001846
544115.0	1001846
544147.0	1000727
544164.0	1001969
544166.0	1003360
544172.0	1001745

# PART NUMBER

PART NUMBER	OPTIBELT AP
544216.0	1003967
545668.1	1000119
545689.0	1003332
545954.0	1002646
549055.0	1003968
549099.0	1003966
549752.0	1002745
549752.2	1002745
551068.0	1000925
551190.0	1000933
554016.0	1003846
554017.0	1003974
560562.0	1001101
560690.0	1000888
566108.0	1001312
567824.0	1001849
567825.0	1001802
570195.0	1003597
570195.1	1001594
570407.1	1002027
570827.0	1001919
570827.1	1001920
572150.0	1001240
573443.0	1000617
573443.1	1000616
577100.0	1002033
577101.0	1002037
577720.1	1001576
577721.0	1001307
578331.0	1001809
578332.0	1001891
580157.0	1003786
580166.0	1003727
584627.1	1002652
600A702	1004000
602387.1	1002956
603013.1	1003412
603015.1	1001503
603017.0	1000833
603017.3	1000833
603033.0	1003619
603048.0	1000503
603122.0	1001116
603247.1	1003626
603283.0	1000669
603284.0	1000507
603290.0	1000764
603317.0	1001515
603336.1	1000478
603337.0	1000662
603341.0	1003328
603354.0	1001844
603378.0	1003388
603380.1	1001080
603427.0	1001627
603430.1	1000823
609762.0	1001713
609822.0	1001854
609823.0	1001225

PART NUMBER	OPTIBELT AP
610152.1	1001033
610196.0	1001029
610197.0	1000903
610830.1	1002789
610833.1	1002788
610835.0	1001031
617001.0	1000941
618123.0	1003434
621903.1	1002041
622156.1	1000207
623252.0	1000917
623427.0	1000410
623427.1	1000409
624131.0	1000194
628175.0	1003438
628533.0	1000818
628579.1	1000862
628630.0	1001208
628779.1	1002871
628780.0	1000862
628782.0	1001320
628784.0	1001586
628785.0	1001881
628787.0	1001955
628788.0	1001887
628791.0	1001929
628792.0	1001834
628847.0	1001214
628847.1	1001213
628888.0	1001684
628978.0	1001670
628981.0	1000431
628991.0	1000433
629000.1	1003661
629001.1	1001934
629002.1	1003395
629035.0	1001289
629036.0	1000515
629081.0	1000754
629133.1	1001935
629142.0	1001954
629214.1	1002317
629279.0	1001936
629366.1	1001821
629402.0	1000409
629410.1	1002872
629436.0	1001630
629441.1	1000810
629445.0	1000209
629510.1	1003634
629580.0	1004078
629732.0	1000415
629732.1	1000416
629732.2	1000417
629737.0	1001511
629739.1	1002791
629756.0	1001209
629763.0	1003593
629764.0	1000097

PART NUMBER	OPTIBELT AP
629769.1	1002699
629836.0	1000746
629836.1	1003819
629908.1	1002332
630011.0	1001129
630118.0	1000959
630144.0	1000965
630156.0	1000980
630169.0	1000962
631904.0	1001162
633030.2	1000220
634019.2	1002792
634046.0	1003419
635494.1	1000382
636021.0	1000882
636021.1	1000883
638037.1	1001018
639226.2	1000260
639373.0	1000924
639417.0	1003352
640653.1	1000350
644014.1	1002319
644015.1	1002913
644016.1	1001800
644017.1	1001236
644018.1	1001243
644141.1	1000476
644177.0	1001221
644209.0	1000699
644267.0	1000243
644362.0	1001077
644368.1	1000858
644369.1	1002873
644391.0	1000802
644399.0	1000855
644403.0	1001247
644404.1	1003354
644405.1	1001941
644418.1	1001212
644419.1	1000832
644447.0	1000420
644448.0	1000139
644465.0	1001818
644509.0	1000718
644514.0	1002530
644537.0	1000140
644538.0	1001655
644539.0	1000871
644685.1	1003359
644771.0	1000752
644781.0	1000123
644843.0	1002286
644866.0	1003618
644884.0	1001321
644885.0	1001825
644889.0	1001658
644890.0	1001664
644891.0	1001573
644892.0	1001860

# PART NUMBER



PART NUMBER	OPTIBELT AP
644893.0	1001608
644894.0	1001709
644895.0	1001875
644896.0	1003656
644897.0	1001870
644898.0	1003601
644899.0	1003540
644902.0	1001639
644927.0	1001054
644928.1	1002439
644942.0	1001385
644961.0	1001930
644965.0	1001864
644966.0	1001823
644969.0	1001588
653059.0	1000960
653060.0	1003653
653062.0	1000964
653063.0	1003572
653064.0	1000968
653120.0	1000929
653121.0	1001030
653380.1	1001032
653450.0	1002137
653779.0	1000909
653933.0	1002119
654013.0	1002233
654534.0	1000913
655408.0	1001527
656028.0	1003335
657793.0	1000107
659025.0	1000094
660409.0	1001575
661031.1	1001564
661031.3	1001564
661092.1	1001238
661093.0	1001581
661114.0	1002336
661128.0	1000796
661220.1	1003340
661239.1	1001244
661244.0	1000125
661245.0	1003377
661298.0	1001630
661301.1	1000840
661337.1	1000845
661345.0	1000160
661361.0	1000287
661362.1	1001951
661378.2	1000852
661425.0	1000357
661427.0	1001228
661429.0	1001212
661430.0	1001229
661435.0	1000688
661451.0	1001958
661458.0	1001957
661469.0	1000726
665999.0	1004055

PART NUMBER	OPTIBELT AP
667219.0	1000222
667238.0	1000693
667242.0	1000225
667245.0	1000413
667246.0	1000384
667248.0	1001317
667249.0	1003591
667250.0	1001586
667251.1	1003601
667252.0	1003602
667253.0	1001704
667255.0	1003357
667256.0	1001592
667367.0	1002582
667427.0	1001839
667452.1	1001302
667453.0	1003350
667454.1	1002870
667456.0	1002554
667457.0	1001079
667458.0	1003642
667477.0	1000387
667511.0	1000347
667530.1	1001163
667551.0	1000867
667551.2	1000867
667554.0	1001926
667560.1	1002597
667561.1	1000168
667651.0	1001706
667673.0	1002549
667680.0	1003353
667681.0	1001583
667682.0	1003594
667683.1	1000738
667684.0	1000595
667788.0	1001014
667798.0	1000307
667798.2	1000310
667845.0	1000663
667846.0	1003506
667858.0	1001703
667881.0	1001320
667891.0	1001013
667891.1	1001012
667934.0	1001645
667947.0	1001633
667957.0	1000320
667958.2	1003598
667958.3	1001593
667973.0	1000340
667974.0	1000411
667981.1	1001589
667981.2	1001588
667983.0	1003645
668619.0	1002644
670224.1	1001158
671012.1	1003631
671013.0	1000674

PART NUMBER	OPTIBELT AP
671013.1	1000676
671015.0	1001287
671083.0	1003588
671209.0	1001039
672350.1	1001795
672351.0	1001570
672353.0	1002875
672358.0	1000662
672359.1	1000477
673601.0	1000512
673614.1	1001566
673625.0	1001793
673638.1	1001099
673639.0	1000963
673639.1	1001114
673690.0	1000558
673690.1	1000558
680334.1	1001819
685693.0	1003773
687046.0	1003448
687046.1	1000323
689175.0	1003391
692149.0	1001852
692150.0	1001857
702509.0	1001090
702536.0	1001200
703314.0	1000296
706087.0	1000365
706829.0	1000524
707001.1	1000426
712386.0	1000001
712419.2	1001199
713506.0	1000315
713506.2	1000315
720607.1	1000457
720695.0	1000734
720696.0	1000467
720866.0	1003607
721211.0	1000115
721295.0	1003401
721306.0	1002276
721307.0	1002277
722107.0	1002278
724043.0	1000236
724100.0	1001907
724101.0	1001682
724141.0	1000709
724168.0	1000624
724179.0	1003423
724180.0	1003615
724181.0	1001679
724193.0	1000254
724247.1	1000849
724248.0	1000848
724248.1	1000850
724301.1	1000648
724339.0	1000630
733308.0	1000483
733309.0	1000895

# PART NUMBER

PART NUMBER	OPTIBELT AP
733311.0	1000620
742023.0	1003629
742024.0	1002876
742025.0	1000650
742026.0	1000328
742026.1	1003800
742027.0	1000297
742028.0	1000259
742030.0	1000673
742131.1	1000334
742143.0	1000394
742162.0	1003385
742182.0	1001340
742206.0	1000277
743910.1	1003202
744785.0	1000326
744833.0	1001961
744833.1	1001963
744873.0	1001338
744874.0	1000088
744913.0	1000376
744963.0	1003845
746505.0	1002272
746506.0	1002784
746507.0	1000446
746508.1	1000266
746509.0	1000450
747508.0	1003430
749701.0	1000167
749712.0	1003611
749813.0	1001861
749817.0	1000436
749819.0	1002521
749824.0	1002438
749828.0	1001681
749859.0	1001974
749886.0	1003657
749886.1	1001928
749895.0	1001828
749914.0	1000720
749951.0	1001518
750192.0	1003464
750193.2	1003399
750284.0	1000891
750288.0	1002794
750288.1	1002794
750294.0	1000251
750296.0	1000198
750316.0	1000454
750382.2	1000114
750624.0	1000197
751112.0	1001161
755070.2	1002795
756051.0	1003508
756059.0	1000889
756446.0	1001674
756466.0	1003613
756474.0	1001078
758662.1	1000240

PART NUMBER	OPTIBELT AP
758719.0	1003405
758853.0	1000456
758854.0	1000449
760869.0	1002648
760870.1	1002434
761412.0	1002567
761979.1	1002668
765985.0	1002287
767057.1	1003333
768125.0	1000034
769005.0	1001019
769202.1	1000495
770214.0	1003560
772647.1	1000485
772657.1	1000619
772658.0	1000935
772659.0	1000937
772660.0	1000936
773313.0	1000480
774099.0	1000511
774100.0	1003481
775698.0	1000272
778561.0	1001038
778717.1	1004307
779212.0	1000486
779213.0	1000482
779214.0	1000452
779272.0	1000459
780419.0	1003559
781038.0	1001020
781047.0	1003679
781394.0	1003672
781399.0	1000300
781400.0	1003433
783268.1	1002055
783430.1	1000238
783876.0	1002091
785168.2	1002318
785169.0	1000437
785170.0	1000451
785172.1	1000290
785174.1	1001056
785175.0	1000594
785176.0	1000389
785341.0	1000295
790502.0	1000355
791307.0	1001009
796343.0	1001194
796344.0	1003211
796450.0	1003969
796474.0	1003217
796998.0	1003945
798779.0	1003946
799181.0	1003970
800306.0	1000514
800309.0	1003435
801221.0	1004103
801222.0	1002798
801491.0	1000942

PART NUMBER	OPTIBELT AP
801680.0	1000348
802530.0	1003441
802931.0	1003456
808761.0	1001347
821249.0	1000105
821734.2	1000154
821813.0	1000102
825944.0	1000176
829080.0	1002806
829094.0	1000245
837192.0	1000155
837195.0	1003368
837543.0	1000099
837546.0	1000172
837828.0	1000113
838227.0	1003756
895105.0	1000938
901573.0	1002988
906561.0	1001300
906736.1	1001987
916529.1	1000148
916532.1	1001893
917533.0	1001554
922188.0	1002799
927654.0	1000602
934301.0	1000254
934417.2	1003531
934418.1	1000684
934418.2	1000687
936409.0	1003440
936718.0	1002800
937031.0	1002801
937997.0	1002804
938486.0	1002807
938931.0	1000322
939297.0	1003036
943227.0	1003760
947112.0	1002812
947916.0	1003750
949396.0	1002814
949670.0	1002815
949888.0	1002772
950133.0	1002816
950327.0	1000314
950890.0	1001931
951457.0	1003837
951654.0	1002813
951655.0	1002818
951889.0	1000281
951917.0	1002797
952578.0	1000288
952937.0	1002820
953002.8	1000460
980850.0	1001801
980851.0	1001829
980852.1	1001805
980853.0	1002877
981678.0	1001547
982376.1	1000644

# PART NUMBER



PART NUMBER	OPTIBELT AP
984885.0	1001810
984885.1	1001810
985517.0	1001804
986390.0	1001942
986700.1	1001847
987883.0	1001943
E040T08	1004022
0549238.0	1004253
783476.0	1004301
761534.0	1000046
7701018005	1000053
094047.0	1000092
327055.0	1000100
316000.0	1000103
854132.0	1000112
750382.0	1000114
750382.1	1000114
6000130463	1000115
660961.0	1000116
213589.0	1000158
633030.0	1000220
633030.1	1000220
027547.0	1000232
027280.0	1000237
020712.0	1000259
639226.0	1000260
639226.1	1000260
746508.3	1000266
376830.1	1000269
938171.0	1000309
713506.1	1000315
635494.0	1000382
022985.0	1000394
2227662.0	1000421
12260820.0	1000488
506671.0	1000506
506671.1	1000506
661301.0	1000840
661337.0	1000845
661378.0	1000852
661378.1	1000852
667551.1	1000867
11205800	1000990
027275.0	1001209
376869.0	1001209
661092.0	1001238
661239.0	1001244
070952.0	1001264
070952.1	1001264
074803.0	1001266
074803.1	1001266
074771.0	1001267
074771.1	1001267
691381.0	1001278
667452.0	1001302
667248.1	1001317
667248.2	1001317
076401.1	1001324
067747.0	1001325

PART NUMBER	OPTIBELT AP
083668.0	1001329
661031.0	1001564
661031.2	1001564
073203.1	1001810
AN1462.0	1001873
661362.0	1001951
661458.1	1001957
569528.0	1002000
360012.0	1002428
584627.0	1002652
7700055692	1002663
6005717341	1002669
2150142.0	1002676
7700074855	1002680
2158661.0	1002683
628964.1	1002687
660811.0	1002732
549752.1	1002745
936823.1	1002765
934862.0	1002765
634019.0	1002792
634019.1	1002792
755070.0	1002795
755070.1	1002795
937605.0	1002813
951654.1	1002813
2150670.0	1003131
7700055691	1003146
11148050	1003157
7700060523	1003190
791717.0	1003192
11205790	1003194
11084620	1003196
7700059172	1003196
11148000	1003198
11147990	1003200
11035860	1003210
2158659.0	1003214
7700043664	1003214
796475.0	1003214
2158663.0	1003220
796786.0	1003220
7700071570	1003230
7700068065	1003235
7700074853	1003253
660382.0	1003254
11147910	1003258
0055893.0	1004361
6000130460	1003394
667251.0	1003601
064168.0	1003635
064168.1	1003635
11148040	1003749
947916.1	1003750
7700074854	1003797
020705.0	1003800
7700060527	1003806
027279.0	1003835
376846.0	1003840

PART NUMBER	OPTIBELT AP
670999.0	1003979
6000133192	1004046
665999.1	1004055
665999.2	1004055
629580.1	1004078
11147960	1004090
670835.0	1004113
AN6461.0	1004113
554396.0	1004114
11147950	1004156
11147940	1004156
11171600	1004259
027286.0	1004265
12316790.0	1004351
660962.0	1004358
325728.0	1004362
555106.0	1004363
326729.0	1004365
827808.0	1004366
665901.0	1004370
665901.1	1004371
660854.0	1004380
922519.0	1004392
1320628.0	1004393
922518.0	1004394
943239.0	1004397
538714.1	1004398
481536.0	1004403
976299.0	1004404
023999.0	1004412
1320382.0	1004411
020706.0	1004418
2227658.0	1004421
660566.0	1004422
949668.0	1004423
922589.0	1004424
950864.0	1004426
027070.0	1004427
744979.0	1004432
027284.0	1004434
027287.0	1004439
623425.1	1004441
7700054412	1003131
11035850	1003975
7700074852	1003975
11080500	1003256
11147900	1003259
7700062485	1004689
670768.0	1004353
628245.0	1004354
545668.2	1004356
483935.0	1004399
1320434.0	1004401
951655.1	1004400
2227556.0	1004407
482122.0	1004408
483721.0	1004409
952937.1	1002820
660488.0	1004420

# PART NUMBER

PART NUMBER	OPTIBELT AP
130931.0	1003800
670796.0	1004440
023220.1	1000650
507317.0	1000762
023219.0	1000772
500049.0	1000920
507278.0	1000959
7700027207	1001042
549011.0	1004410
554098.1	1001622
027581.0	1001720
176432.2	1001685
545178.0	1001797
025242.0	1002717
023218.0	1003629
376894.0	1001852
376968.0	1001862
11114270	1003159
11205791	1002652
7701029701	1002462
7701030341	1002464
7701029702	1002465
11408440	1004875
7701030342	1004875
7701029703	1002468
7701029705	1002474
11408400	1002936
7700008696	1002936
7701029707	1002483
6005000844	1002494
11408430	1004878
7700042689	1004706
7700042688	1004707
7700042687	1004708
7700027471	1004725
360007.0	1002510
568234.0	1002512
7700059682	1004726
7700056666	1002537
11408410	1004713
6005000493	1002552
11408420	1002946
6005000475	1002554
7700010200	1002555
147227.0	1003722
796728.0	1003775
324073.0	1003775
315972.0	1002948
11430440	1002944
7700018067	1002944
147232.1	1003770
796719.0	1002944
530142.0	1002944
11085260	1002971
761411.1	1002971
11085270	1002945
11125690	1004873
320008.0	1002950
7700042907	1004728

PART NUMBER	OPTIBELT AP
7700037231	1004729
7700040497	1002735
105660.0	1002719
103037.0	1002135
940490.0	1003011
640208.0	1003687
6000133265	1004827
6005022912	1002410
673614.0	1001566
673638.0	1001099
680334.0	1001819
712419.0	1001199
720607.0	1000457
724301.0	1000648
750193.1	1003399
758662.0	1000240
760870.0	1002434
767057.0	1003333
769202.0	1000495
772657.0	1000619
778717.0	1004307
783430.0	1000238
785172.0	1000290
906736.0	1001987
938171.2	1002803
980852.0	1001805
982376.0	1000644
622156.0	1000207
629002.0	1003395
532011.0	1003396
667798.1	1000307
640653.0	1000350
629739.0	1002791
610833.0	1002788
610830.0	1002789
509035.0	1000430
644141.0	1000476
603336.0	1000478
629410.0	1002872
060306.0	1000723
667683.0	1000738
629081.1	1000754
061701.1	1000790
629441.0	1000810
603430.0	1000823
644419.0	1000832
603017.2	1000833
724247.0	1000849
644369.0	1002873
644368.0	1000858
667454.0	1002870
628579.0	1000862
060949.0	1000863
628779.0	1002871
061360.1	1000870
061353.0	1000870
061253.0	1000873
0617309.2	1000954
653380.0	1001032

PART NUMBER	OPTIBELT AP
644015.0	1002913
577720.0	1001576
629769.0	1002699
667981.0	1001589
667958.1	1003598
176440.0	1001636
176432.0	1001685
603380.0	1001080
176543.0	1001793
644016.0	1001800
603247.0	1003626
644685.0	1003359
671012.0	1003631
629510.0	1003634
667255.1	1003357
176442.0	1003641
670224.0	1001158
667530.0	1001163
073204.1	1001183
629001.0	1001934
629133.0	1001935
176542.0	1001936
644405.2	1001941
629000.0	1003661
644404.0	1003354
352371.0	1001982
073201.1	1002004
073202.0	1002012
570407.0	1002027
644418.0	1001212
176474.1	1001236
644017.0	1001236
644018.0	1001243
133630.0	1002961
133549.0	1002973
602387.0	1002956
133635.0	1002958
667560.0	1002597
549055.1	1003968
603015.0	1001503
621903.0	1002041
211148.0	1002114
629214.0	1002317
644014.0	1002319
629908.0	1002332
142232.0	1003950
0554186.0	1004087
094046.1	1002777
105860.0	1003442
661220.0	1003340
660851.1	1004442
549144.0	1004443
782209.0	1004445
061088.0	1004446
638367.1	1004448
664017.0	1004452
927323.1	1004456
376855.0	1004457
067290.0	1004463

# PART NUMBER



PART NUMBER	OPTIBELT AP
A0139973592	1004463
666290.0	1004468
665798.0	1004485
665830.0	1004486
060307.0	1004487
2210757.0	1004504
660762.1	1004505
554031.0	1004506
554087.0	1004508
549097.0	1004509
545188.0	1004512
548189.0	1004513
545175.0	1004516
670752.0	1004518
2227544.0	1004522
177432.3	1004524
545174.0	1004526
549151.0	1004528
027324.0	1004529
428232.0	1004530
428189.0	1004536
667947.1	1004537
554269.0	1004538
554279.0	1004539
505051.0	1004550
660821.0	1004567
495008.0	1004569
349579.0	1004607
554361.0	1004610
660569.0	1004611
665824.0	1004624
361787.0	1004630
V011532.0	1004635
140755.0	1004636
428216.0	1004642
034628.0	1004656
660554.0	1004663
660464.0	1004666
V209707.0	1004667
660587.0	1004668
144550.0	1004676
144551.0	1004677
140756.0	1004679
633564.0	1004697
144299.0	1004699
067289.0	1004700
360011.0	1004702
147218.1	1004711
660965.0	1004735
027508.0	1004737
768457.0	1004738
977506.1	1004771
977505.1	1004780
746550.0	1004788
670999.2	1004795
744874.1	1004797
360009.0	1004806
365119.0	1004814
214243.0	1004821

PART NUMBER	OPTIBELT AP
0854277500	1004830
1320324.0	1004830
847959.0	1004831
827809.0	1004832
027323.0	1004839
144898.0	1004839
644209.1	1004843
644209.2	1004843
570195.2	1004846
660315.0	1004846
660815.0	1004848
660815.1	1004848
024664.0	1004852
027327.0	1004857
027322.0	1004858
660314.0	1004860
660314.1	1004860
130906.0	1004866
142845.1	1004866
353706.1	1004868
144298.0	1004874
144298.1	1004874
317432.1	1004880
147220.0	1004886
0480477.0	1004891
0131808.0	No AP
050154.1	No AP
060306.3	No AP
061704.0	No AP
090265.0	No AP
090266.0	No AP
090267.0	No AP
090268.0	No AP
090286.0	No AP
123543.0	No AP
124205.0	No AP
124215.0	No AP
124225.0	No AP
124231.0	No AP
124232.0	No AP
124233.0	No AP
124235.0	No AP
130901.0	No AP
130934.0	No AP
130998.0	No AP
130999.0	No AP
131801.0	No AP
131802.0	No AP
131803.0	No AP
131995.0	No AP
131996.0	No AP
131997.0	No AP
131998.0	No AP
131999.0	No AP
1324222.0	No AP
140765.0	No AP
144356.0	No AP
144361.0	No AP
2227586.0	No AP

PART NUMBER	OPTIBELT AP
2227635.0	No AP
233510.0	No AP
378330.0	No AP
429256.0	No AP
429272.0	No AP
429280.0	No AP
495431.0	No AP
539443.0	No AP
545176.0	No AP
545186.0	No AP
545187.0	No AP
549187.2	No AP
549237.0	No AP
554032.0	No AP
554110.0	No AP
554121.0	No AP
554141.0	No AP
554141.1	No AP
554150.0	No AP
554172.0	No AP
554201.0	No AP
554216.1	No AP
554339.0	No AP
554365.0	No AP
567824.1	No AP
596978.0	No AP
628789.0	No AP
629110.0	No AP
630025.0	No AP
630043.1	No AP
644362.1	No AP
660423.0	No AP
660455.0	No AP
660506.0	No AP
660894.0	No AP
661362.2	No AP
661541.0	No AP
665222.0	No AP
665825.0	No AP
665825.1	No AP
665827.1	No AP
665832.0	No AP
665833.0	No AP
665834.0	No AP
665865.0	No AP
665957.0	No AP
665967.0	No AP
667254.0	No AP
667993.1	No AP
670723.0	No AP
670724.0	No AP
670751.0	No AP
695610.0	No AP
720696.1	No AP
733361.0	No AP
744870.0	No AP
744965.0	1004897
761979.0	No AP
785173.0	No AP

# PART NUMBER

PART NUMBER	OPTIBELT AP
790461.0	No AP
822597.0	No AP
905037.0	No AP
544216.1	1003967
695610.1	No AP
056961.0	1000117
0545307.0	1002869
<b>DEUTZ</b>	
2235180	1002462
2235181	1002465
2234343	1002485
2235177	1002487
2235056	1002494
1175765	1002586
2239152	1002943
4325382	1003702
4359336	1003732
4342249	1003735
01101674	1003477
01116059	1000092
01116061	1004046
01116064	1000104
01116078	1000194
01116087	1003334
01132421	1002110
01148079	1003163
01148492	1003171
01148512	1003172
01148874	1003183
01151369	1002584
01153065	1004385
01154304	1002972
01154305	1003775
01154306	1002944
01154307	1002945
01154308	1002969
01154310	1002956
01154311	1002590
01154312	1002976
01154347	1002464
01154348	1002467
01154350	1002468
01154351	1002508
01154352	1002529
01154353	1002532
01154354	1002537
01154355	1002539
01154357	1002547
01154358	1002558
01154359	1002579
01156921	1002935
01160050	1000050
01161860	1000025
01162716	1000028
01164848	1000009
01168307	1000024
01168308	1000024
01168311	1000051

PART NUMBER	OPTIBELT AP
01168313	1000053
01168314	1000054
01168318	1000055
01168322	1000059
01168328	1000062
01168330	1000064
01168333	1000066
01168334	1000065
01169886	1000015
01172391	1000057
01174283	1002961
01174612	1002453
01174834	1002958
01175719	1002551
01175745	1002941
01175765	1002497
01175766	1002495
01175882	1002940
01175924	1002922
01175928	1002456
01175929	1002455
01175933	1002526
01175939	1002965
01175960	1002934
01175968	1002983
01175969	1002946
01175970	1002554
01175974	1002560
01176178	1002473
01176304	1002920
01176330	1002562
01176331	1002471
01177873	1002983
01178736	1002978
01178739	1002961
01179461	1002460
01179471	1002444
01179472	1002445
01179474	1002451
01179475	1002471
01179476	1002478
01179477	1002920
01179478	1002497
01179479	1002532
01179480	1002485
01179481	1002943
01179564	1002465
01179565	1002460
01179566	1002462
01179639	1002507
01179648	1002447
01179650	1002521
01179673	1002567
01179674	1002933
01179675	1002922
01179718	1002483
01179720	1002488
01179722	1002932
01179747	1002475

PART NUMBER	OPTIBELT AP
01179749	1002931
01179777	1002452
01179779	1002495
01179780	1002497
01179781	1002498
01179782	1002499
01179830	1002521
01179852	1003769
01179888	1002936
01179890	1002534
01179891	1002978
01179978	1002455
01179988	1002455
01179996	1002456
01180027	1002461
01180150	1002547
01180172	1002539
01180173	1002468
01180182	1002534
01180194	1002487
01180195	1002456
01180350	1002554
01180434	1002443
01180435	1003715
01180436	1002558
01180437	1003735
01180438	1002579
01180449	1001043
01180464	1002520
01180467	1002526
01180468	1002529
01180516	1003723
01180517	1002584
01180552	1002549
01180553	1002738
01180612	1002560
01180619	1002537
01180640	1002444
01180663	1002985
01180709	1002449
01180830	1002484
01180831	1002473
01180846	1002465
01180848	1002522
01180849	1002528
01180901	1002448
01180904	1002962
01181076	1002539
01181126	1002545
01181184	1002453
01181185	1002545
01181254	1001046
01181366	1002466
01181587	1002549
01181675	1002441
01181897	1002498
01182045	1002451
01182046	1002532
01182050	1002447



# PART NUMBER



PART NUMBER	OPTIBELT AP
01182051	1002452
01182052	1002534
01182053	1002455
01182054	1002547
01182055	1002539
01182056	1002456
01182057	1002558
01182059	1002520
01182060	1002526
01182061	1002529
01182062	1002560
01182063	1002537
01182064	1002444
01182065	1002449
01182067	1002522
01182068	1002962
01182184	1002468
01182185	1003775
01182207	1002500
01182293	1003121
01182294	1003138
01182339	1002500
01182347	1004315
01182369	1004315
01182373	1003121
01182423	1003135
01182425	1003135
01182426	1002642
01182428	1002642
01182429	1002500
01182432	1003133
01182449	1004315
01182470	1002646
01182471	1004317
01182499	1002937
01182505	1002532
01182542	1002542
01182558	1002646
01182559	1004317
01182599	1003172
01182607	1004182
01182651	1003177
01182718	1003174
01182730	1004315
01182731	1004315
01182732	1003121
01182733	1003121
01182740	1000981
01182810	1002492
01183023	1002482
01183024	1002925
01183073	1003192
01183129	1002642
01183130	1002642
01183131	1002642
01183133	1003121
01183134	1003121
01183135	1003121
01183136	1002646

PART NUMBER	OPTIBELT AP
01183137	1003135
01183138	1003135
01183139	1003135
01183153	1000981
01183154	1004315
01183155	1004315
01183164	1004317
01183165	1004318
01183173	1003193
01183205	1002531
01183250	1002514
01183361	1003171
01183362	1003174
01183363	1003177
01183364	1003172
01183366	1003193
01183367	1003183
01183371	1003130
01183377	1000981
01183380	1004313
01183391	1004182
01183398	1003163
01183403	1002549
01183420	1004312
01183480	1003969
01183558	1004313
01183704	1003127
02234343	1002485
02235056	1002494
02235175	1002478
02235176	1002931
02235177	1002487
02235178	1002459
02235179	1002460
02235180	1002462
02235181	1002465
02235253	1002457
02235254	1002483
02235255	1002492
02235256	1002492
02235257	1002942
02235259	1002472
02235260	1002936
02235262	1002918
02235377	1002450
02235421	1002498
02235530	1002924
02235531	1002475
02235532	1002925
02235533	1002482
02235713	1002451
02235714	1002481
02235816	1002933
02237477	1002452
02419104	1002985
04123559	1002568
04147300	1002571
04154401	1001044
04154525	1001045

PART NUMBER	OPTIBELT AP
04154836	1001042
04156387	1001043
04156783	1001041
04232845	1002933
04305745	1002525
04325382	1002514
04325871	1003700
04342249	1003735
04343181	1002556
04359336	1002567
04437559	1002586
04438414	1002947
04450657	1002951
04452089	1003781
04452440	1002736
04452801	1002521
04454180	1002632
04455177	1002545
01151370	1002596
01179750	1002475
12270923	1002515
12270924	1002483
12272665	1002584
12500121	1002590
12500125	1003775
12500218	1002956
12500266	1002961
12500285	1002965
12500311	1002459
4154525	1001045
4325382	1002514
603450200900	1002450
603450201100	1002459
603450201400	1002922
603450201450	1002492
603450211050	1002529
603450211075	1002532
603450211275	1002554
603450211375	1002562
603450211400	1002567
603450211425	1002571
603450501200	1002468
603450501225	1002471
603450501300	1002478
60345051225	1002471
603451111075	1002532
603451111350	1002560
603451111400	1002567
603451111550	1002586
603451111700	1002976
603451311400	1002567
603451311500	1002581
603451391622	1002375
01168316	1004470
01182312	1004473
01182360	1004473
01182367	1004473
01182728	1004473
01182729	1004473

# PART NUMBER

PART NUMBER	OPTIBELT AP
01182830	1004473
01182831	1004473
01182832	1004473
01183144	1004473
01183145	1004473
01183146	1004473
01183147	1004473
01183148	1004473
01183149	1004473
01182310	1004688
01182365	1004688
01183150	1004688
01183151	1004688
01183559	1004688
02235261	1004704
01178461	1004705
01179088	1004709
01178737	1004710
02418962	1004710
01175555	1004713
01178738	1004713
16029939	1004722
01179456	1004724
00673224	1004727
01183019	1004773
01180847	1004851
01183335	1004871
01180833	1004876
01182066	1004876
<b>DEUTZ-FAHR</b>	
6210922	1000360
16006626	No AP
16015922	1001613
16015923	1003664
16026321	1001290
16029939	1002607
16031403	1001297
16031404	1001138
16031538	1001603
16042133	1001239
16062738	1003981
16617104	1002405
0.018.9044.0	1001724
0.018.9690.0	1003980
01100903	1002851
01104054	1000887
01116060	1000094
01116062	1003367
01116063	1000100
01116080	1000196
01116089	1000217
01116091	1003400
01116092	1003402
01116093	1003414
01116094	1003425
01116095	1000288
01116096	1003438
01116097	1000336

PART NUMBER	OPTIBELT AP
01116113	1000492
01116114	1000494
01116131	1000605
01129779	1000228
01129780	1002817
01129970	1002247
01130742	1003431
01136717	1003422
01136724	1000514
01136729	1003566
01136731	1000952
01136747	1002240
01137509	1003407
01139067	1002856
01139068	1003460
01139070	1003478
01139071	1000505
01139073	1000521
01139074	1000522
01139076	1000525
01139078	1000530
01139079	1000602
01139080	1000623
01139081	1003519
01139082	1003544
01139083	1000738
01139084	1003547
01139085	1000784
01139086	1000795
01139088	1000864
01139089	1000902
01139090	1000926
01139091	1003568
01139092	1000943
01139093	1000948
01139204	1002257
01139205	1002275
01139206	1002278
01139207	1002111
01139209	1002232
01139210	1003312
01139213	1002260
01139234	1002065
01139235	1002080
01139237	1002081
01139240	1002152
01139241	1002193
01139242	1002200
01139243	1000438
01139244	1000439
01139245	1000442
01139246	1000443
01139247	1000445
01139248	1000448
01139250	1000465
01139251	1000469
01139252	1000545
01139253	1002210
01139254	1002215

PART NUMBER	OPTIBELT AP
01139256	1002230
01139258	1002245
01139259	1002246
01139260	1002251
01139300	1002061
01139301	1000779
01139634	1002106
01141373	1000675
01141503	1001698
01141530	1000435
01141554	1000535
01141595	1002907
01141608	1001637
01141622	1000665
01141623	1002239
01141626	1002908
01141642	1002108
01141643	1000735
01141644	1000812
01141666	1000794
01141758	1000694
01141765	1000366
01141770	1000639
01141788	1002841
01141789	1003462
01141792	1001807
01141798	1000792
01141801	1002101
01141816	1001630
01141818	1002100
01141819	1001644
01141823	1000772
01141840	1000356
01141850	1000398
01141882	1000654
01141894	1000706
01141917	1000659
01141918	1001650
01141938	1003513
01141958	1000682
01142150	1003536
01143410	1002835
01143412	1002909
01143413	1002852
01143497	1000398
01145003	1003458
01145026	1001541
01145047	1003411
01145051	1000333
01145052	1000350
01145053	1000434
01145054	1000427
01145055	1000825
01145143	1000665
01145186	1000764
01145203	1000658
01145211	1000768
01145214	1000308
01145215	1000324

# PART NUMBER



PART NUMBER	OPTIBELT AP
01145216	1000354
01145218	1000408
01145226	1001657
01145260	1001612
01145262	1001595
01145263	1000407
01145318	1002046
01145335	1000847
01145367	1000091
01145374	1001541
01145449	1003522
01145461	1000685
01145462	1003532
01145475	1000689
01145481	1000780
01145504	1000683
01145505	1000671
01145625	1003424
01145631	1002853
01145633	1000799
01145667	1001622
01145685	1000293
01145697	1000393
01145699	1000564
01145725	1002854
01145738	1000629
01145782	1000273
01145790	1002839
01145792	1000770
01145823	1002090
01145884	1000685
01145921	1000042
01145922	1003558
01145937	1002914
01145940	1002844
01145949	1000776
01145959	1002849
01145960	1002755
01145970	1000043
01145973	1002761
01145977	1000268
01145989	1002855
01145990	1000560
01160990	1000019
01162717	1000052
01163087	1000029
01168304	1000018
01179132	1000545
01180447	1001041
01180448	1001042
01180450	1001045
01181260	1001044
01231688	1000813
01231696	1000819
01231697	1000838
01339252	1003485
01397518	1002102
01397596	1000581
01397776	1002831

PART NUMBER	OPTIBELT AP
01397850	1002809
03210969	1003483
04437549	1001050
04453084	1000981
06204283	1000044
06204284	1002057
06204285	1002069
06204286	1002999
06204287	1003000
06204288	1002075
06204289	1000509
06204291	1000652
06204295	1000529
06204296	1000978
06204297	1000979
06204300	1000444
06204304	1000880
06204305	1000440
06204310	1003477
06204314	1002163
06204315	1000464
06204317	1000462
06204318	1000475
06204322	1000906
06204324	1002177
06204325	1000455
06204326	1000471
06204327	1000474
06204329	1000479
06204331	1002127
06204332	1000961
06204333	1000958
06204334	1003605
06204335	1000957
06210851	1003535
06210853	1000406
06210869	1003377
06210870	1000136
06210874	1000190
06210880	1000199
06210881	1000201
06210889	1003408
06210890	1003410
06210894	1003427
06210904	1003759
06210906	1003446
06210912	1000330
06210913	1000331
06210915	1000339
06210916	1003455
06210917	1000343
06210918	1000344
06210919	1000348
06210921	1000356
06210923	1000364
06210924	1003461
06210925	1000375
06210927	1000390
06210929	1000418

PART NUMBER	OPTIBELT AP
06210930	1000428
06210932	1000493
06210934	1000496
06210938	1000497
06210939	1000498
06210941	1000499
06210943	1000502
06210947	1003479
06210951	1000510
06210953	1003480
06210954	1000516
06210955	1000517
06210957	1000518
06210960	1000523
06210963	1000526
06210969	1003483
06210970	1003488
06210971	1003491
06210973	1003500
06210975	1000599
06210977	1003504
06210978	1003508
06210981	1003511
06210984	1003516
06210986	1000632
06210988	1000646
06210989	1003526
06210990	1000654
06210991	1000660
06210992	1000670
06210993	1003531
06210994	1003533
06210996	1000684
06210997	1003541
06210999	1000724
06211001	1000751
06211003	1000763
06211004	1000769
06211006	1003550
06211009	1000814
06211010	1000826
06211014	1000879
06211016	1000884
06211019	1000889
06211020	1000890
06211023	1000892
06211024	1000896
06211025	1000897
06211026	1003561
06211027	1000901
06211031	1000907
06211032	1000914
06211033	1000920
06211034	1000923
06211041	1003569
06211042	1000945
06211043	1000947
06211046	1000951
06211053	1000893

# PART NUMBER

PART NUMBER	OPTIBELT AP
06212833	1002994
06212839	1002258
06212840	1002259
06212842	1002261
06212843	1002262
06212845	1002264
06212855	1002279
06212871	1002055
06212872	1002055
06212874	1002059
06212883	1002077
06212885	1002078
06212890	1002083
06212894	1002093
06212895	1002105
06212896	1002109
06212900	1003420
06212907	1002199
06212909	1000437
06212915	1000447
06212918	1000461
06212919	1000463
06212924	1002211
06212925	1003686
06212927	1003314
06212932	1002234
06212933	1002235
06214290	1000531
06215191	1001035
06215192	1001036
06215193	1001037
06215219	1000977
06215231	1001638
06215234	1001696
06215235	1001699
06215236	1001679
06215238	1001628
06215239	1001601
06215240	1001578
06215241	1001691
06215242	1001686
06215243	1003616
06228207	1002098
06235567	1003041
06241147	1000468
06241910	1002229
06242124	1002857
06254069	1000453
06254070	1000441
06255583	1002910
06256381	1000306
06256546	1002759
06256547	1000313
06256619	1002762
06256714	1002763
06257897	1000854
06257898	1002911
06273236	1000736
06273237	1000811

PART NUMBER	OPTIBELT AP
06298998	1002067
06301463	1003316
06580049	1002998
06580119	1002094
114291.3	1003867
2.4119.213.0	1001724
9351.0176.00	1004018
T040H02	1004017
0.0183111.0	1000039
0.017.4868.0	1000230
01146013	1000301
16062842	1000302
6215207	1001002
1145590	1001008
6215195	1001062
6215196	1001064
6215197	1001066
1141820	1001067
1145097	1001073
1145064	1001069
1145202	1001075
6215199	1001071
1145224	1001072
1145332	1001073
1145369	1001074
1145331	1001075
1145724	1001076
1141762	1001092
6215203	1001094
6215204	1001097
6215205	1001100
6215206	1001106
6259006	1001155
1145334	1001156
6215217	1001157
6204307	1001176
6215211	1001197
6204313	1001200
6215212	1001201
6215226	1001210
6215220	1001222
6215222	1001223
6215223	1001223
1141971	1001224
1141944	1001226
6215221	1001227
1145057	1001269
1145680	1001298
1145742	1001299
1145744	1001309
1145628	1001311
6240268	1001372
1142840	1001383
6215202	1001420
1141637	1001440
6273876	1001440
6215208	1001441
1141904	1001457
1145626	1001459

PART NUMBER	OPTIBELT AP
1145726	1001464
1145802	1001466
6215209	1001472
6215214	1001517
6215213	1001519
6215215	1001520
6215216	1001522
1141624	1001710
1145188	1001716
1141625	1001727
1141749	1001738
1145187	1001740
1146033	1001744
1141502	1001748
1141613	1001749
1145632	1001750
1145750	1001752
6215245	1001763
1145479	1001767
1145025	1001779
6215244	1001787
1145102	1001788
1145457	1001810
1145261	1001827
6215250	1001833
6215253	1001843
1145329	1001863
1141941	1001865
6215257	1001882
1141591	1001902
1174974	1001903
1141909	1001909
6215258	1001912
6285949	1001916
1145050	1001917
1145690	1001925
1145866	1001926
1145751	1001927
6204311	1001937
6215261	1001964
1145459	1001981
1145865	1001991
1145660	1001994
1141510	1002013
1145689	1002017
6215262	1002022
1145056	1002028
4435634	1002432
2235713	1002451
1139214	1002452
2237477	1002452
1139215	1002453
1139216	1002458
1139217	1002459
2235178	1002459
2231579	1002460
2235179	1002460
2235180	1002462
1139218	1002465

# PART NUMBER



PART NUMBER	OPTIBELT AP
6212847	1002465
1181366	1002466
1139219	1002468
1139220	1002475
2235531	1002475
6212850	1002475
1139221	1002478
2235175	1002478
6212851	1002478
2235533	1002482
1139222	1002483
2235254	1002483
6212852	1002483
2234343	1002485
2235177	1002487
2235255	1002490
2235421	1002498
1182429	1002500
1145668	1002509
1180848	1002522
4305745	1002525
1154357	1002547
1168325	1002556
1139233	1002558
1176330	1002562
4437560	1002592
4438414	1002592
4452440	1002736
1180553	1002738
6241305	1002917
2235532	1002925
2235176	1002931
4450657	1002951
2419104	1002985
6212834	1003059
4455253	1003105
1148874	1003183
6215255	1003331
1141645	1003620
1141615	1003624
1141912	1003631
1145458	1003651
6215237	1003655
4325871	1003700
4452801	1003704
1181185	1003713
4455177	1003713
1180516	1003723
4343181	1003724
1180517	1003742
4437559	1003743
4452089	1003781
1182599	1003813
01169889	1004338
2.4119.210.0	1004385
2.4119.211.0	1004368
16062841	1004379
2.4119.208.0	1004396
01146045	1004419

PART NUMBER	OPTIBELT AP
01146027	1004436
16061769	1004840
16055471	1004655
36200413	1000700
3170529	1000707
33700746	1003547
3170537	1004844
01145330	1001636
01145640	1001734
01146032	1001742
16062885	1004540
16062737	1004541
3651575	1001806
06215254	1001810
01145961	1001821
01145630	1004139
06215248	1001901
16062265	1004585
01182600	1004312
01181748	1004312
01181768	1004313
01181730	1000981
01183156	1004316
01182767	1004318
16039033	1004544
1141888	1004549
16024474	1004579
1146076	No AP
16062883	No AP
16064323	No AP
16063211	No AP
1-99-51995	1004183
6225210	No AP
16062735	1004641
1182499	1002937
1178461	1004705
1179777	1002452
1179988	1002455
1179565	1002460
1179564	1002465
1180173	1002468
1180833	1004876
1182339	1002500
1178685	1004724
1180847	1004851
1154352	1002529
1180468	1002529
1179088	1004709
1183205	1002531
1168314	1002532
1178737	1004710
1179479	1002532
1180619	1002537
1182063	1002537
1180172	1002539
16062763	1002540
16062884	1002541
1180150	1002547
1154311	1002590

PART NUMBER	OPTIBELT AP
1145693	1004736
01139227	1002045
06212866	1002049
01136734	1002050
01139231	1002051
01139232	1002055
0.017.9350.0	1002055
01145991	1004093
01141556	1002117
06210922	1000360
01145465	1001164
01169885	1000011
01141613	1001749
4454180	1002632
06215228	1004494
1-99-51021	1004496
01145980	1004507
16062737/20	1004542
01145877	1004543
01145703	1004545
01145368	1004565
06215249	1004576
06215251	1004580
0.018.1930.0	1004593
1-99-71575	1004596
01145627	1004658
01182726	1004688
01182727	1004688
01183152	1004688
01139224	1004752
06212828	1004754
01141555	1004755
2.4119.203.0	1004811
2.4119.205.0	1004812
X221765	1004813
0.018.3550.0	1004831
2.4119.204.0	1004832
317-0537	1004844
06240407	1004845
11116150117.00	1004845
16062737/10	1004853
16062737/30	1004853
0.017.7465.0	1004854
01145348	1004854
0.018.1907.0	1004857
2.4119.207.0	1004883
01139228	1004884
01139230	1004885
06212870	1004886
01145484	No AP
01145766	No AP
01180913	No AP
01182044	No AP
01445465	No AP
02929933	No AP
02931480	No AP
04437867	No AP
04439434	No AP
06215194	No AP

# PART NUMBER

PART NUMBER	OPTIBELT AP
06215218	No AP
06215225	No AP
06528420	No AP
11 0464	No AP
2.4119.209.0	No AP
<b>DRONNINGBORG</b>	
41902600	1000086
41903000	1000089
41904900	1000112
41905300	1000114
41909000	1003748
41911000	1000143
41912300	1003380
41912400	1003381
41922200	1000186
41924900	1003394
41926100	1000224
41926300	1000230
41926600	1000235
41928100	1003415
41928900	1000249
41929000	1000251
41929200	1003424
41930200	1000260
41930300	1003426
41932600	1000289
41932800	1003437
41933700	1002760
41934800	1002768
41934900	1003445
41935200	1000318
41935500	1000321
41935700	1003447
41935900	1000328
41936200	1002770
41936700	1000327
41937300	1000339
41937500	1002773
41937600	1003450
41938900	1000356
41939300	1000366
41940900	1000385
41942100	1000404
41942200	1000410
41950000	1000625
41950100	1000627
41950200	1003539
41950300	1002859
41950400	1003517
41950600	1003524
41950900	1000600
41953700	1003505
41954100	1000645
41954800	1003537
41955400	1000724
41955800	1000757
41955900	1000704
41957600	1000656

PART NUMBER	OPTIBELT AP
41957800	1000706
41958500	1000859
41962000	1000192
41962600	1000201
41963900	1000233
41964300	1003405
41964400	1003409
41964500	1003408
41966500	1003444
41966900	1003449
41972100	1001352
41972200	1001353
41972300	1001353
41972800	1001355
41974300	1001357
41978400	1001725
41978500	1001365
41978800	1001683
41978900	1001730
41979000	1001632
41979100	1001607
41979400	1001251
41979600	1003347
41979800	1001990
41979900	1003576
41980300	1001439
41980600	1001439
41980800	1001501
41980900	1001526
41981000	1001539
41981100	1001436
41981200	1001427
41981900	1000570
41982100	1000582
41982200	1003499
41982400	1003501
41982500	1000585
41983500	1000611
41983600	1000611
41983900	1003521
41984100	1000655
41984300	1000898
41985200	1000603
41985300	1003514
41985600	1000693
41986100	1000675
41986300	1000756
41986500	1000805
41986800	1000684
41987100	1000602
41987200	1003518
41987300	1000815
41987600	1000853
41987900	1000575
41988000	1000698
41988700	1003562
41988900	1000899
41989100	1000915
41989200	1000908

PART NUMBER	OPTIBELT AP
41989400	1000911
41989900	1001375
41990001	1002212
41990009	1002357
41990050	1003600
41990051	1001877
41990068	1001368
41990069	1001378
41990100	1001377
41990400	1003581
41991000	1002346
41991300	1001836
41991400	1001559
41991600	1003647
41991700	1001844
41992100	1001643
41992200	1001653
41992400	1000918
41992700	1000910
41993000	1001104
41993400	1003633
41994300	1001215
41994600	1001845
41995100	1000546
41995600	1001822
41995700	1001429
41996100	1002080
41996300	1002205
41996400	1002071
41996500	1002150
41997200	1003676
41997600	1002197
41998700	No AP
41998800	1000278
41998900	No AP
41999200	1004068
41999700	1002208
41999800	1002207
41987800	1000620
D41929000	1000251
D41986100	1000675
D41957800	1000706
D41972300	1001353
D41972800	1001355
D41981200	1001427
D41995700	1001429
D41981100	1001436
D41980300	1001439
D41980600	1001439
D41980900	1001526
D41932800	1003437
D41998700	No AP
<b>FELLA</b>	
117118	No AP
117140	1001021
117141	1001022
118311	No AP
121282	1002998

# PART NUMBER



PART NUMBER	OPTIBELT AP
121404	No AP
121745	1002997
122075	1002385
122076	1002372
122129	1003014
122253	1003047
122254	No AP
122297	1002104
122299	1002107
122649	1003015
122651	1004302
122652	1003017
122764	1002157
122968	1003018
123027	1002178
124976	1002102
124977	1003868
<b>FENDT</b>	
28274029	1001797
41921801	1004180
41929000	1000251
41937800	1002774
41939300	1000366
41975300	1004165
41978000	1001304
41978100	1003606
41978800	1001683
41979600	1003347
41979800	1001990
41979900	1003576
41981100	1001436
41981200	1001427
41986300	1000756
41990007	1003778
41990057	1003659
41990059	1001262
41990064	1001303
340433154	1003374
340433197	1000164
340433253	1000231
340433422	1000606
340433423	1000613
340433474	1000789
340433539	1001120
340434138	1001061
340435150	1001422
340435152	1001539
344311117	1003592
344311123	1001622
344311131	1001640
344311151	1001717
344311227	1001820
344311318	1002000
344312128	1003623
685121585	1004124
41980500	1004070
LA340433253	1000231
D41929000	1000251

PART NUMBER	OPTIBELT AP
LA340433474	1000789
LA340434138	1001061
LA340433539	1001120
D41990064	1001303
LA340433984	1001346
LA340435150	1001422
D41981200	1001427
D41981100	1001436
LA340435152	1001539
LA344311123	1001622
LA344311131	1001640
LA344311227	1001820
LA344311318	1002000
LA340433154	1003374
LA344311117	1003592
LA344312128	1003623
D41980500	1004070
<b>FORTSCHRITT</b>	
4240023354	1001000
4240023362	1001207
4240023370	1001990
4240023387	1001956
4240023395	1003652
4240040388	1002185
4240043405	1003779
4240043413	1002142
4240044254	1002231
4240044262	1002131
4240044270	1003005
4240044287	1002079
4240044295	1003680
4240044301	1002148
4240046545	1002989
4250121764	1003650
4250121772	1001617
4250121780	1001663
4260699960	1001915
4260699977	1001649
4260699985	1001901
4260703942	1001869
4260715183	1001892
4270722244	1001513
9911860628	1002881
9911861645	1002076
06014350	1003003
061011077	1002153
4250129747	1003314
4254138832	1002185
4260700023	1003007
61009074	1001858
61020978	1001900
61004680	1002002
60168160	1003348
4240044246	1002881
<b>GOMSELMASH</b>	
13x1230	1000110
13x3030	1003857

PART NUMBER	OPTIBELT AP
13x3580	1003930
14x10x887	1003942
14x10x937	1003934
16x11x1650	1003932
17x1220	1000206
17x1790	1003419
17x1890	1003862
17x1890 A	1000252
17x2690	1003866
22x5000	1004192
2-HBx1912	1003872
2-HBx2162	1001582
2-HBx2362	1003599
2-HBx2362 A	1003873
2-HBx2512	1003961
2-HBx2512 A	1003875
2-HBx2512 AA	1003876
2-HBx2662	1003877
2-HBx2907	1003878
2-HBx2962	1003962
2-HBx2962 A	1003879
2-HBx3110	1003607
2-HBx3110 A	1001630
2-HBx3212	1003882
2-HBx3212 A	1003883
2-HBx3812	1001663
2-HBx3812 A	1003885
2-HBx4812	1003887
2-HBx4812 A	1003888
38x18x1500	1001003
3-HBx2162	1001814
3-HBx2162 A	1003890
3-HBx2662 A	1003892
3-HBx2886	1004080
3-HBx3612	1003894
3-HBx3762	1003649
3-HBx3812	1003929
3-HBx3812 A	1003895
3-HBx4985	1003965
3-HBx4985 A	1003897
4-HA2886 A	1004191
4-HAx2240	1004190
4-HBx1912	1003928
4-HBx3612	1002726
4-HBx4562	1003904
4-HBx4562 A	1003905
52x16x1250	1004187
5-HBx3612 A	1003907
5-HBx3812	1003963
5-HBx3812 A	1003909
68x24x2600	1001291
68x24x2600 A	1004085
7-HBx9100 AA	1003912
8-SPCx2240	1003956
alternative Gomselmash	1003870
SPAx1032	1003913
SPAx1120	1002046
SPAx1400	1003914
SPBx1250	1002110

# PART NUMBER

PART NUMBER	OPTIBELT AP
SPBx1500	1002117
SPBx1800	1002127
SPBx2240	1003677
SPCx2800	1003686
HB 2990	1003859
2-HB 4062 "K"	1004262
3-HB 1900	1004264
3-HB 2907	1003294
3-HB 3350 A	1001869
4-HB 2500 K	1004263
SPA 1157	1002049
B95.02297	1000323
2-HB 4062	1004262
3-HB 3350	1001869
4-HB 2500	1004263
17x2950	1000336
<b>GRIMME</b>	
B95.02004	1002832
B95.02005	1002830
B95.02006	1003406
B95.02025	1000501
B95.02045	1002182
B95.02047	1001358
B95.02070	1000348
B95.02114	1000274
B95.02116	1002173
B95.02120	1000675
B95.02122	1000504
B95.02125	1002167
B95.02126	1003019
B95.02128	1003020
B95.02131	1000520
B95.02134	1000508
B95.02142	1002833
B95.02145	1003021
B95.02149	1000250
B95.02150	1002793
B95.02152	1004302
B95.02155	1000228
B95.02158	1003762
B95.02162	1002764
B95.02165	1002834
B95.02166	1003413
B95.02167	1003344
B95.02170	1002600
B95.02171	1000342
B95.02188	1002154
B95.02193	1002158
B95.02205	1003024
B95.02207	1000589
B95.02208	1003025
B95.02209	1000588
B95.02210	1000593
B95.02223	1002113
B95.02224	1002125
B95.02225	1002136
B95.02226	1000761
B95.02227	1000837

PART NUMBER	OPTIBELT AP
B95.02228	1002837
B95.02229	1002888
B95.02232	1002129
B95.02241	1000260
B95.02244	1001349
B95.02245	1001344
B95.02246	1000626
B95.02247	1000828
B95.02250	1002765
B95.02259	1003528
B95.02260	1002889
B95.02261	1000870
B95.02262	1002325
B95.02263	1002331
B95.02265	1000768
B95.02079	1000502
B95.02033	1000511
B95.02161	1003408
B95.02118	1004405
B95.02269	1000263
B95.05866	1004415
B95.02008	1004429
B95.02117	1004430
B95.02009	1004435
B95.05902	1004094
B95.02308	1000580
B95.02281	1000624
B95.02329	1000828
B95.02293	1003895
B95.02106	1002460
B95.02309	1002588
	1002589
B95.02169	1002595
B95.02280	1002601
B95.02288	1001354
B95.02240	1002095
B95.02239	1002099
B95.02111	1003023
B95.02113	1004213
B95.02017	1004447
B95.02026	1004449
B95.02147	1004450
B95.02035	1004451
B95.02124	1004453
B95.02304	1004458
B95.02318	1004459
B95.02330	1004460
B95.02090	1004461
B95.02273	1004462
B95.02326	1004465
B95.02339	1004474
B95.02274	1004478
B95.02325	1004479
B95.02327	1004480
B95.02272	1004481
B95.02328	1004483
B95.02332	1004484
B95.02338	1004552
B95.02337	1004553

PART NUMBER	OPTIBELT AP
B95.02336	1004554
B95.02271	1004555
B95.05891	1004556
B95.02331	1004557
B95.05842	1004578
B95.02294	1004587
B95.05873	1004732
B95.02044	1004739
B95.02049	1004742
B95.02348	1004756
B95.02314	1004757
B95.02341	1004759
B95.02343	1004761
B95.05856	1004762
B95.02306	1004763
B95.02319	1004765
B95.02206	1004766
B95.02292	1004767
B95.02342	1004768
B95.02127	1004769
B95.02211	1004770
B95.02146	1004774
B95.02290	1004777
B95.02138	1004783
B95.02333	1004858
B95.02001	1004893
(B95.02293)	No AP
(B95.02294)	No AP
B95.02104	No AP
B95.02151	No AP
B95.02289	No AP
B95.02302	No AP
B95.02317	No AP
B95.02322	No AP
B95.05854	No AP
B95.05876	No AP
B95.05934	No AP
<b>INTERNATIONAL HARVESTER COMPANY (IHC)</b>	
1250587C1	1003476
164550R2	1000102
280210C2	1000115
3055715R1	1002556
3119750R1	1002446
3129139R1	1002588
3129140R1	1002586
3136258R1	1000064
704449R1	1000090
709502R1	1003382
874097C1	1000051
401128R2	1002576
<b>JOHN DEERE</b>	
41959200	1004091
84012974	1004093
84238514	1004074
4032807792	1004089
7700068536	1004095
01145789	1004094



# PART NUMBER



PART NUMBER	OPTIBELT AP
0554086.0	1004098
0660316.0	1004099
10VX00D	1004026
600A01	1003993
600A02	1003992
600A07	1003999
600A11	1003991
600A16	1004004
9351.0198.00	1004019
AH127866	1003765
AH139436	1001382
AH150678	1002892
AH158880	1002861
AH160080	1000681
AH163931	1001381
AH202773	1002893
AH84633	1001087
AJ58940	1002580
AR72036	1002351
AT262958	1003226
AZ100807	1003826
AZ100808	1003827
AZ100809	1003828
AZ100810	1003829
AZ22914	1002915
AZ25400	1002206
AZ35635	1001105
AZ37807	1001108
AZ39676	1002766
AZ39677	1001343
AZ39678	1002843
AZ40077	1002843
AZ41136	1002894
AZ43804	1002819
AZ43805	1000202
AZ46283	1002348
AZ51312	1003982
AZ51638	1004153
AZ56225	1002313
AZ61336	1003831
B28170	1003106
C22534	1000228
CA20518	1003386
CC100317	1003632
CC100318	1001831
CC100752	1003654
CC100753	1001899
CC100754	1001894
CC102733	1001841
CC18089	1000550
CC19065	1001004
CC21115	1001006
CC26949	1001826
CC26973	1001814
CC38627	1002334
CQ00626	1001126
CQ00628	1001758
CQ03265	1000603
CQ03283	1002874

PART NUMBER	OPTIBELT AP
CQ03457	1000684
CQ03478	1000402
CQ03492	1002811
CQ05208	1001123
CQ08238	1000150
CQ08239	1000151
CQ12236	1000109
CQ13375	1003404
CQ13673	1000085
CQ13800	1000035
CQ17755	1000225
CQ24186	1000363
CQ24340	1000132
CQ28344	1001736
CQ31965	1001584
CQ33577	1002520
CQ34122	1002524
CQ34237	1000129
CQ34345	1001631
CQ35417	1002655
CQ35426	1001867
CQ35531	1001565
CQ35559	1001731
CQ37755	1002427
CQ39824	1001734
CQ40221	1003955
CQ40222	1001563
CQ42066	1003143
CQ42150	1000650
CQ45617	1003783
CQ48048	1001634
CQ50143	1003238
CQ50144	1003188
CQ51920	1003131
CQ51921	1003817
CQ53362	1000610
CQ53363	1001263
CQ53364	1001886
CQ53367	1003612
CQ53369	1000244
CQ53370	1001546
CQ53371	1000592
CQ53372	1001838
CQ57311	1002749
CQ58873	1003235
CQ58875	1003183
CQ62911	1001137
CQ62912	1001028
DQ20810	1002560
DQ23754	1002591
DQ29594	1001107
E46113	1003505
E58967	1004189
EP0020	1000220
FH10165	1001844
H101813	1002580
H108175	1001140
H113749	1001514
H115759	1001543

PART NUMBER	OPTIBELT AP
H115881	1003663
H125380	1000791
H125381	1000778
H126345	1001124
H128010	1000797
H128234	1000419
H131169	1001392
H136881	1000693
H138761	1000701
H138762	1000710
H139963	1000221
H140160	1003570
H140404	1001434
H141166	1001394
H141167	1004088
H141429	1001149
H146636	1004193
H151952	1003570
H152146	1001435
H152180	1001431
H153297	1001551
H154723	1000738
H154731	1000586
H156541	1001785
H157104	1002437
H157514	1004131
H157523	1001633
H158512	1000853
H162541	1001774
H162629	1001543
H163515	1003209
H163576	1001965
H164368	1003830
H165072	1001425
H165708	1001579
H166759	1000857
H166870	1004090
H168301	1000708
H170047	1001548
H172610	1003244
H173832	1002685
H174455	1003217
H174456	1003114
H174457	1001777
H174885	1001777
H175467	1003125
H175587	1004166
H175628	1000180
H176536	1003126
H176765	1001789
H176766	1001756
H176882	1001088
H177177	1001905
H177178	1001913
H177186	1003223
H177263	1001394
H177383	1001128
H177442	1001917
H177589	1002285

# PART NUMBER

PART NUMBER	OPTIBELT AP
H178037	1002433
H178757	1003110
H201596	1001141
H201794	1000671
H201916	1002436
H202821	1001759
H203474	1004057
H204133	1004197
H204747	1001656
H205240	1003230
H206048	1001426
H206738	1001393
H206807	1002435
H209507	1004136
H210001	1000678
H210003	1000650
H211581	1004059
H211601	1001433
H213353	1004109
H216026	1004130
H217352	1001772
H218645	1001393
H219182	1000708
H21925	1000694
H221273	1004112
H221324	1000678
H221732	1004130
H223212	1004134
H223230	1004137
H223384	1004142
H223385	1004133
H228346	1004143
H228347	1004149
H229018	1004145
H229019	1004144
H230230	1004138
H230909	1004058
H232997	1001606
H235564	1001656
H236472	1004059
H23950	1000682
H27433	1000598
H76136	1000542
H80103	1000709
H80896	1002570
HXE10501	1004142
HXE10556	1004133
HXE10785	1003785
J57007	1002735
J57065	1002737
J57234	1002514
L101166	1003205
L101411	1003796
L110391	1003210
L110599	1003091
L11060	1001286
L110600	1002633
L110602	1002671
L110603	1002672

PART NUMBER	OPTIBELT AP
L110605	1002680
L110607	1003214
L110608	1003216
L110609	1003220
L111148	1002635
L111169	1002634
L111170	1003797
L111600	1003131
L111601	1003238
L111602	1003244
L111685	1003788
L111801	1003799
L111804	1002677
L111933	1003223
L114286	1003815
L114290	1003754
L114292	1003242
L114293	1003248
L114468	1003245
L114487	1003184
L114488	1003186
L114489	1000987
L115657	1003214
L115658	1003087
L115660	1002669
L115661	1002671
L153280	1003185
L153281	1003227
L153282	1003231
L155538	1003090
L166309	1003790
L169272	1003802
L169273	1003798
L200916	1002696
L201806	1002693
L202229	1002697
L202230	1002694
L203293	1002695
L203295	1002698
L79344	1002679
L79943	1003206
L79945	1003220
M45862	1000108
M82461	1000098
N110085	1000702
N153524	1003063
N154241	1003064
N157368	1003060
N157369	1003061
N371322	1003121
P51165	1003755
R101069	1003062
R106120	1003184
R106122	1003156
R107324	1003810
R108842	1003816
R111090	1003065
R115257	1003092
R115935	1003803

PART NUMBER	OPTIBELT AP
R115936	1003215
R116492	1000990
R118317	1003173
R118318	1003220
R120524	1003791
R120852	1003164
R122126	1003135
R123292	1003798
R123294	1003140
R123296	1003142
R123306	1003149
R123307	1003134
R123308	1003955
R123432	1003141
R123436	1003145
R123437	1003139
R123438	1003144
R123439	1003136
R123440	1003811
R123441	1003782
R123442	1003146
R123445	1003148
R123449	1003138
R123450	1003143
R123451	1003150
R123453	1002650
R123454	1002651
R123456	1003147
R123457	1003156
R123458	1003158
R123459	1003159
R123460	1002652
R123461	1002650
R123462	1003153
R123463	1003152
R123464	1003154
R123465	1003221
R123466	1003223
R123468	1003157
R123469	1003160
R123470	1003222
R123522	1003198
R124785	1003118
R125361	1003193
R125752	1002655
R128196	1003161
R128197	1003787
R128198	1003169
R128199	1003172
R128200	1002660
R128201	1003176
R128202	1003178
R128203	1003180
R128204	1002662
R128205	1003191
R128206	1003195
R128208	1003199
R128209	1003200
R128210	1003263

# PART NUMBER



PART NUMBER	OPTIBELT AP
R128806	1003075
R129083	1003791
R129738	1002686
R130478	1003078
R130852	1003128
R130899	1003253
R131083	1003067
R131213	1003084
R131433	1002683
R131434	1003261
R132159	1003248
R132925	1003081
R133402	1003216
R133518	1003195
R133693	1003119
R133694	1003111
R133695	1003108
R133696	1003112
R133697	1003814
R133699	1003127
R133700	1003122
R133701	1003117
R133703	1003187
R133704	1003071
R133705	1003070
R133706	1003074
R133707	1003080
R133852	1003073
R133853	1003203
R134299	1002669
R134594	1003230
R134625	1003155
R134630	1003077
R134631	1003079
R134632	1003069
R134634	1003076
R134635	1003113
R134636	1003109
R134637	1000982
R134638	1003124
R135169	1003133
R135188	1003234
R135189	1003229
R135192	1002652
R135193	1002679
R135194	1003224
R135195	1003155
R135198	1003260
R135199	1003235
R135200	1003165
R135438	1003955
R135568	1003164
R135589	1003159
R135590	1003161
R135591	1003787
R135592	1003167
R135593	1003169
R135594	1003170
R135595	1003171

PART NUMBER	OPTIBELT AP
R135596	1003172
R135597	1003178
R135598	1003174
R135599	1002660
R135600	1003176
R135601	1003180
R135602	1003184
R135603	1002662
R135604	1003189
R135605	1003190
R135606	1003191
R135607	1003194
R135608	1003195
R135609	1003196
R135611	1003200
R135612	1003246
R135613	1003248
R135614	1003804
R135615	1002687
R135663	1003802
R135664	1003254
R135665	1003256
R135680	1003158
R135681	1003143
R135822	1001195
R135823	1002662
R135824	1003174
R135826	1003749
R135977	1003749
R136235	1002684
R136284	1003209
R136535	1003163
R156049	1003237
R156050	1003239
R157687	1003118
R164820	1003114
R174754	1003195
R175712	1003180
R175825	1003068
R175826	1003192
R181917	1003245
R181918	1003264
R202628	1003243
R208755	1003793
R216071	1004075
R500089	1003166
R500090	1003249
R500173	1003213
R500244	1003219
R500377	1003152
R500378	1003240
R500380	1003088
R500381	1003217
R500382	1003089
R500383	1003955
R500384	1003148
R500385	1003242
R501007	1003132
R501017	1003130

PART NUMBER	OPTIBELT AP
R501053	1003160
R501191	1003258
R501266	1003120
R501308	1003241
R501526	1003265
R502016	1003204
R502078	1003259
R502086	1003197
R502089	1003262
R502186	1003193
R502306	1003082
R502416	1003754
R502417	1001196
R502418	1002665
R502476	1003168
R502599	1002651
R503311	1003072
R503312	1002614
R503323	1003066
R503324	1003123
R503505	1003207
R503571	1003250
R503726	1003129
R503932	1003208
R504022	1002651
R504023	1003225
R504618	1003220
R504963	1003142
R505186	1003749
R505810	1003093
R505812	1003094
R515127	1001017
R515209	1003210
R515217	1003095
R515219	1003096
R515220	1003097
R515222	1003098
R517012	1003099
R517039	1003100
R517041	1003101
R521053	1004156
R73784	1003983
R87153	1002302
R94373	1003812
R95917	1002651
R95924	1003247
R98510	1003784
S07074	1001757
S07075	1001112
S13042	1001412
S17044	1000033
S17045	1000144
S33510	1000609
S33512	1004198
S33607	1004199
S60001	1000569
S60004	1000569
S60011	1001851
S60016	1000553

# PART NUMBER

PART NUMBER	OPTIBELT AP
S60018	1000623
S60021	1001996
S60022	1000607
SA00101	1000703
SA00201	1000717
SA00301	1000538
SA00401	1000646
SA00601	1000686
T148208	1003175
T155457	1002655
T160034	1003171
T160036	1003181
T164949	1002643
T166823	1003115
T178409	1003171
T178410	1003162
T178411	1003806
T178412	1003257
T178413	1003174
T178414	1003166
T178415	1003147
T178416	1003251
T178417	1003154
T178418	1003116
T178419	1002662
T178420	1003143
T178421	1003791
T178422	1003156
T178423	1003200
T178536	1003179
T178537	1003177
T178538	1003813
T178548	1003808
T180368	1003233
T182169	1003086
T184590	1003229
T184592	1003184
T184594	1003749
T184595	1003225
T185061	1003172
T185081	1003182
T186776	1002650
T187391	1003085
T190384	1003225
T190809	1002658
T190817	1003176
Z103844	1001815
Z103845	1001571
Z105041	1003590
Z105506	1002642
Z20459	1003583
Z20460	1000697
Z20562	1000753
Z20703	1000679
Z20743	1003505
Z20823	1003587
Z21171	1003371
Z21254	1003372
Z21398	1000561

PART NUMBER	OPTIBELT AP
Z21400	1003496
Z21500	1001103
Z21501	1001102
Z22208	1003720
Z23693	1000695
Z23752	1000095
Z25473	1003494
Z25670	1001118
Z27710	1001102
Z28458	1000594
Z28842	1003571
Z29962	1004146
Z30130	1001111
Z30692	1001407
Z30881	1000766
Z31283	1000038
Z32173	1001979
Z32190	1000002
Z32568	1004129
Z32883	1000157
Z33368	1000603
Z33605	1000162
Z33774	1000401
Z33790	1001995
Z33967	1001497
Z34099	1001523
Z34121	1003586
Z34405	1000675
Z34786	1000040
Z34828	1003397
Z35357	1003621
Z35358	1003361
Z35965	1000153
Z36120	1001438
Z36376	1001452
Z36499	1003543
Z36770	1003752
Z36771	1001682
Z36813	1001397
Z37191	1004105
Z37192	1004106
Z37473	1003589
Z38186	1001647
Z38699	1003389
Z38703	1002344
Z38704	1000039
Z38708	1003497
Z39312	1001118
Z39313	1001109
Z39314	1001121
Z41178	1001396
Z41728	1001828
Z41932	1000229
Z42382	1002811
Z42756	1002350
Z42757	1003343
Z42758	1000228
Z43253	1003492
Z43863	1000036

PART NUMBER	OPTIBELT AP
Z43890	1003643
Z44740	1000747
Z44761	1001668
Z44762	1001723
Z44936	1001542
Z45026	1000261
Z45191	1000003
Z45192	1002425
Z45367	1002426
Z45482	1003400
Z46222	1001861
Z46365	1001404
Z46463	1001261
Z46709	1001832
Z46759	1002333
Z46764	1004107
Z47763	1001735
Z47911	1000604
Z47912	1000607
Z48212	1001769
Z48567	1002618
Z51089	1001689
Z51202	1001733
Z51212	1001027
Z51707	1001634
Z52009	1002575
Z52909	1003856
Z53288	1001507
Z53478	1001737
Z54332	1004183
Z54406	1001122
Z54807	1001096
Z55459	1001085
Z55645	1001739
Z55771	1002360
Z55801	1000786
Z56313	1000305
Z56351	1004184
Z56352	1004185
Z56421	1001084
Z56829	1000316
Z56959	1001089
Z58751	1004084
Z58752	1000788
Z58886	1003711
Z59114	1000324
Z59286	1001911
Z59322	1000640
Z59342	1003622
Z59344	1003858
Z59419	1001125
Z59556	1000635
Z59557	1001388
Z59930	1001734
Z60135	1000395
Z60930	1001784
Z60931	1003623
Z61150	1001754
Z61151	1001761

# PART NUMBER



PART NUMBER	OPTIBELT AP
Z61152	1001764
Z61153	1001753
Z61154	1001448
Z61827	1001755
Z61857	1001190
Z61858	1001973
Z62110	1001423
Z62111	1001432
Z62211	1001449
Z62213	1003856
Z62214	1001127
Z62551	1001784
Z62552	1001786
Z63005	1000648
Z63322	1003832
Z64912	1001751
Z66787	1001097
Z66873	1001924
Z67285	1000299
Z67326	1001926
Z73506	1003268
Z73879	1000631
Z75245	1003201
Z75246	1003266
Z77222	1002692
Z78834	1004069
Z81070	1003083
H161945	1004251
H111519	1004270
H156796	1004269
340435138	1004295
Z31367	1001452
HXE35958	1000124
CA22534	1000228
HXE41402	1001196
HXE17071	1002643
155538	1003090
R211183	1003119
HXE24688	1003129
HXE43428	1003142
HXE24687	1003159
HXE28843	1003221
HXE24086	1003368
Z37121	1004106
SA36536	1004309
HXE34567	1004386
HXE24085	1004352
H238679	1004355
H238867	1004367
HXE44273	1004372
CQ61084	1004375
Z103479	1004381
H175631	1004382
ZY86859	1004384
VK648223	1004395
AZ63883	1004416
HXE35957	1004417
ZY94047	1004431
ZY96551	1004433

PART NUMBER	OPTIBELT AP
Z32158	1004437
ZY94115	1000671
ZY96558	1000680
ZY95337	1000796
H221327	1000650
H240972	1003528
H240895	1004060
H160080	1000680
H232237	1000685
HXE24210	1000693
Z103867	1000701
H240885	1000708
H155998	1000764
AH236689	1000768
HXE46515	1004315
SA36101	1004321
SAU12081	1004322
SA36192	1004323
SA36701	1004324
SA36717	1004325
SA35274	1004326
SAU11321	1004327
SA36523	1004328
SAU11644	1004329
SAU11645	1004330
SAU10552	1004331
SAU11158	1004332
SAU11284	1004333
SA35425	1004334
SAU10691	1004335
SA36024	1004320
SAU11073	1004336
Z101214	1004349
AXE33760	1002913
HXE17164	1001576
H224185	1001606
HXE39397	1001612
H201571	1001633
H221731	1004197
HXE11255	1004137
VK648215	1001826
FH10164	1001838
H105040	1001968
H228261	1001996
HXE51300	1001394
HXE15594	1004058
CQ05106	1001523
H210476	1001543
Z43808	1002354
Z38697	1001996
Z53515	1001973
Z63327	1001751
Z43889	1002707
L41330	1002595
L41331	1002598
L59206	1002599
H228250	1001145
L203299	1001336
L203300	1003803

PART NUMBER	OPTIBELT AP
L203302	1002677
L203305	1002662
L203306	1003185
L213022	1003802
L213023	1003798
Z23087	1004454
H160831	1004455
AH233198	1004464
Z103861	1004467
H175632	1004469
HXE15556	1004475
AXE24473	1004499
HXE19401	1004502
HXE20763	1004534
HXE34473	1004535
HXE16928	1004551
AH228935	1004563
AXE33418	1004564
CC38702	1004568
FH305097	1004571
HXE12427	1004572
HXE12426	1004573
VK648204	1004584
HXE12425	1004588
VK648216	1004589
H240974	1004594
H220052	1004595
H229882	1004597
H162310	1004598
HXE13957	1004603
HXE13951	1004604
HXE39119	1004606
CC32123	1004607
H228523	1004618
AXE26321	1004626
AXE10456	1004660
AZ58519	1004672
Z39750	1004673
SA36130	1004674
L172523	1004675
H174367	1004686
H228260	1004686
H228348	1004686
L203307	1004691
CQ71838	1004693
CQ71839	1004694
L203294	1004695
Z48472	1004727
AXE29294	1004730
AZ101386	1004731
Z103583	1004753
CC107199	1004789
H238871	1004790
H238870	1004794
H238869	1004798
CC109629	1004800
AZ45824	1004803
CC119474	1004807
Z81937	1004809

# PART NUMBER

PART NUMBER	OPTIBELT AP
SA36521	1004815
HXE15546	1004816
HXE15547	1004817
CC32124	1004823
CC38984	1004825
AZY83541	1004838
Z23475	1004841
Z23476	1004841
Z24729	1004842
H241212	1004850
AS33603	1004855
AYC10133	1004855
AXE25334	1004856
HXE29021	1004856
HXE35822	1004868
AS26639	1004882
AYC10132	1004882
Z104104	1004884
Z104978	1004885
H240888	1004890
HXE38000	1004892
AXE10455	No AP
AXE17661	No AP
AXE17662	No AP
AXE22550	No AP
AXE27897	No AP
C17165	No AP
C19647	No AP
CQ02867	No AP
CQ03160	No AP
CQ06153	No AP
CQ33886	No AP
DQ05106	No AP
DQ06154	No AP
E41055	No AP
H125565	No AP
H125711	No AP
H132808	No AP
H134216	No AP
H134344	No AP
H134437	No AP
H139436	No AP
H143869	No AP
H145158	No AP
H157105	No AP
H161648	No AP
H165545	No AP
H166457	No AP
H169449	No AP
H173024	No AP
H177887	No AP
H180896	No AP
H201334	No AP
H205169	No AP
H207851	No AP
H208431	No AP
H218726	No AP
H220911	No AP
H221498	No AP

PART NUMBER	OPTIBELT AP
H234704	No AP
H241000	No AP
H241230	No AP
H81742	No AP
H86259	No AP
HXE17475	No AP
HXE22617	No AP
HXE36535	No AP
HXE43172	No AP
HXE43696	No AP
HXE46027	No AP
HXE47062	No AP
L111087	No AP
L115659	No AP
PT9483	No AP
R106123	No AP
R115614	No AP
R123293	No AP
R124786	No AP
R131436	No AP
R133702	No AP
R134599	No AP
R157688	No AP
R206983	No AP
R239551	No AP
R300380	No AP
R300399	No AP
R500379	No AP
R500616	No AP
R502461	No AP
R96255	No AP
S165708	No AP
S26382	No AP
S33602	No AP
S33721	No AP
S37687	No AP
SA00501	No AP
T178465	No AP
T178539	No AP
T187704	No AP
T189016	No AP
T190810	No AP
Z106227	No AP
Z21399	No AP
Z21401	No AP
Z21402	No AP
Z21403	No AP
Z22556	No AP
Z22648	No AP
Z24833	No AP
Z31867	No AP
Z59435	No AP
Z65924	No AP
Z78860	No AP
ZY83680	No AP
ZY83683	No AP
ZY84252	No AP
ZY87107	No AP
ZY87108	No AP

PART NUMBER	OPTIBELT AP
ZY90073	No AP
ZY91187	No AP
ZY94046	No AP
ZY94048	No AP
ZY94114	No AP
ZY96548	No AP
ZY96549	No AP
ZY96550	No AP
ZY96552	No AP
ZY96554	No AP
ZY96555	No AP
ZY96557	No AP
ZY97051	No AP
ZY97322	No AP
ZY97323	No AP
ZY97324	No AP
ZY97760	No AP
H218197	1004597

## JOHN DEERE - TURF N CARE

TCU12829	1003102
TCU13749	1003103
TCU16026	1003104
TCU16841	1003107
TCU31132	1004775
	1004782
TCU29452	1004778
TCU30510	1004779
TCU29453	1004781
TCU29454	1004784
TCU30356	1004785
TCU31194	1004786
TCU29455	1004787

## KPAB

904020	1001740
904022	1001715
904030	1001767
904033	1001603
904036	1001701
904041	1000856
904042	1000291
904043	1000312
904045	1001742
904047	1001744
904051	1003981
904052	1003980
904028	1004265
904044	1000268
904034	1004266
904035	1004267
904009	1003933
904049	1004268

## KRONE

2150791	1001331
2168800	1001294
2211880	1003730
2240410	1001970

# PART NUMBER



PART NUMBER	OPTIBELT AP
2253560	1002363
2253610	1000182
2266930	1001333
2279090	1001332
2279101	1003580
2279251	1001966
2282321	1003722
2282330	1003730
2282340	1003741
2282350	1002601
2282360	1003016
2282430	1002353
9215002	1003029
9215010	1002675
9215030	1002844
9215040	1001932
9215050	1002802
9215060	1001803
9215070	1001235
9215090	1001793
9215101	1002292
9215102	1002290
9215110	1002052
9215121	1003030
9215130	1000229
9215140	1001983
9215151	1001940
9215161	1002023
9215181	1002049
9215190	1002188
9215221	1002190
9215232	1003683
9215241	1002024
9215251	1001555
9215260	1003027
9215270	1002065
9215280	1002331
9215290	1000242
9215310	1001580
9215320	1001796
9215330	1003284
9215360	1001792
9215370	1002032
9215380	1001596
9215390	1001988
9215400	1003031
9215412	1003394
9215420	1001602
9215450	1002288
9215470	1001791
9215520	1001587
9215530	1002341
9215540	1001574
9215550	1001555
9215560	1001791
9215570	1001796
9215931	1002140
9215962	1002160
9215981	1003026

PART NUMBER	OPTIBELT AP
9216000	1003032
9216010	1004306
9216070	1002171
200208260	1004113
200211640	1004154
200216850	1004178
200225361	1001584
E020T17	1004005
02253610	1000182
09215130	1000229
09215290	1000242
09215601	1000259
09215050	1002802
09215030	1002844
09215412	1003394
270079810	1004308
270036680	1004378
270087820	1004634
270095150	1004637
270085150	1004638
270029402	1004639
2159940	1004643
270085120	1004644
270096080	1004645
270089770	1004657
270086200	1004670
2279091	1001332
200213750	1004680
2133350	1004682
270063910	1004671
270104130	1004495
09215251	1001555
09215540	1001574
09215330	1003284
09215310	1001580
09215520	1001587
09215380	1001596
270073020	1001598
09215420	1001602
270059850	1003961
270036620	1004847
270085130	1004510
270096090	1004849
200225360	No AP
9215580	1004566
270078750	1004570
270076720	1004616
200160010	1001970
270016482	1004617
270022770	1004619
270016491	1004620
270085110	1004664
270096100	1004665
270084780	1004661
270084781	1004662
270042650	1001332
270042651	1004681
270010830	1004683
200213740	1004684

PART NUMBER	OPTIBELT AP
270095930	1001340
270095940	1004881
270103490	1004881
09215181	1002049
09215110	1002052
270096890	1002061
09215270	1002065
270050740	1002065
270003340	1004751
270089880	No AP
270104120	No AP
09215981	1003026
09215931	1002140
02153350	1003012
200236560	No AP
200214040	No AP
200229240	No AP
270012960	No AP
09215121	1003030
02282360	1003016
09215962	1002160
09215010	1002675
09215002	1004083
09215260	1003027
09216070	1002171
09216000	1003032
09215400	1003031
09216010	1004306
270009750	1004772
09215190	1002188
09215232	1003683
09215221	1002190
270097250	1004776
270092541	1004796
270050730	1004810
09215280	1002331
09215530	1002341
02282430	1002353
02253560	1002363
270045470	1004828
09215300	1000255
09216030	1000489
09215101	1004799
09215102	1004808
09215451	1004822
09215460	No AP
270107440	No AP
<b>KUHN</b>	
83101059	1002275
83101067	1002272
83101252	1002337
83101253	1002342
83101270	1002060
83101656	1002386
83101658	1002383
83101670	1002161
83101672	1003022
83101673	1003023

# PART NUMBER

PART NUMBER	OPTIBELT AP
83101680	1002370
83101682	1002374
83101687	1003056
83101688	1003057
83101764	1002366
83101785	1003416
83101791	1002398
83101792	1002399
83101795	1000258
83101796	1000270
83101797	1000279
83101798	1002845
83111677	1001173
83111679	1001219
83111682	1001191
83111683	1001192
<b>KVERNELAND</b>	
37771407	1000295
43301603	1003439
43303407	1002401
43303410	1002373
43303412	1002377
43303413	1002371
43303417	1002376
43303418	1002402
43303420	1002364
43303424	1002384
43303426	1002395
43303427	1002306
43303429	1002305
43303432	1002382
43303434	1002393
99201011	1000093
99201014	1000104
99201017	1000108
99201020	1000113
99201032	1000137
99201038	1000141
99201040	1000142
99201411	1002044
99201412	1002040
99201413	1002041
99201414	1002045
99201418	1002050
99201420	1002084
99201422	1002085
99201424	1002086
99201510	1002330
99202008	1002293
99202009	1003045
99202011	1002294
99202012	1000204
99202013	1004194
99202014	1002785
99202015	1000216
99202016	1002757
99202017	1000231
99202018	1002846

PART NUMBER	OPTIBELT AP
99202019	1002778
99202021	1002805
99202022	1000240
99202024	1003046
99202025	1003421
99202026	1003422
99202027	1003763
99202028	1002847
99202031	1000257
99202032	1002308
99202035	1000292
99202036	1000298
99202038	1000303
99202039	1000305
99202040	1003441
99202041	1000313
99202042	1000248
99202062	1000370
99202063	1000373
99202220	1002243
99202322	1001790
99202325	1001794
99202409	1002367
99202410	1003058
99202412	1002117
99202413	1002118
99202415	1002115
99202420	1002133
99202423	1002174
99202424	1003236
99202425	1003033
99202428	1002203
99202429	1002195
99202430	1002129
99202431	1003034
99202433	1004303
99203005	1000538
99203006	1000539
99203008	1000544
99203010	1003486
99203012	1000553
99203014	1000561
99203015	1000565
99203016	1002895
99203017	1003497
99203018	1000575
99203019	1002897
99203020	1002898
99203021	1003507
99203022	1002900
99203023	1000596
99203024	1002899
99203025	1003766
99203026	1003767
99203027	1002896
99203029	1000624
99203038	1000675
99203039	1000679
99203042	1000697

PART NUMBER	OPTIBELT AP
99203045	1003545
99203046	1000711
99203048	1000716
99203050	1000724
99203052	1000732
99203056	1000745
99203063	1000769
99203082	1002902
99203083	1002903
99203085	1000576
99203086	1002904
99203087	1000578
99203088	1002905
99203090	1000588
99203091	1002901
99203093	1000684
99203203	1000767
99203204	1002906
99203208	1002241
99203210	1002242
99203211	1002244
99203212	1002225
99203213	1002227
99203215	1002221
99203216	1002222
99203218	1003040
99203245	1002254
99203250	1002255
99203310	1001150
99203315	1001151
99203320	1001152
99203330	1001272
99203331	1001273
99203332	1001274
99203333	1001153
99203335	1001154
99203415	1000912
99203418	1000918
99203419	1000919
99203422	1000922
99204062	1000969
99204076	1000973
99207010	1001345
99207113	1001348
99207225	1001341
0000930	1000206
0000930D	1000206
0000930M	1002296
0000939	1003334
0000942	1000208
0000942D	1000208
0000943	1000544
0000944	1003490
0001108	1002271
0001218	1002273
01142085	1002404
AC494745	1001026
AC494836	1001025
AC690011	1002416



# PART NUMBER



PART NUMBER	OPTIBELT AP
AC690071	1002739
AC690081	1002419
AC690115	1002413
AC690123	1002417
AC690131	1002420
AC690132	1002419
AC690137	1002411
AC690138	1002418
AC690140	1000989
AC690149	1002414
AC690150	1002416
AC690164	1002410
AC690181	1002412
AC690201	1002407
AC690202	1002406
ND9036	1003674
ND9073	1002095
ND9092	1002197
ND9198	1003676
ND9240	1003673
ND9257	1002052
ND9359	1003681
ND9471	1003680
ND96001	1000369
ND96006	1000733
ND96008	1002103
ND96016	1002185
ND96023	1002202
ND96029	1000397
ND96053	1003684
ND96063	1002099
ND96067	1002184
ND96068	1002196
ND96070	1002159
ND96074	1002050
ND96075	1002204
ND96078	1002579
ND96082	1002327
ND96083	1002054
ND96084	1003682
ND96085	1002328
ND96087	1002191
ND96089	1002189
ND96090	1002063
ND96091	1002194
ND96096	1002356
ND96108	1002166
ND96109	1002139
ND9629	1002328
ND9630	1003692
ND9674	1000361
ND9704	1002187
ND9732	1002388
ND9775	1002144
ND9909	1002132
ND9928	1002375
ND9958	1002179
RG00035618	1002274
RG00037276	1002272

PART NUMBER	OPTIBELT AP
RG00040590	1002275
RG00040922	1002270
RG00040955	1002269
1224	1001278
1160	1001279
1099	1001280
KZK YENISEY	
28X16 X 1180 LP	1003306
28X16 X 1450 LP	1003307
38X18 X 1500 LP	1001003
38X18 X 2000 LP	1003308
38X18 X 2400 LP	1003309
3-HB 1650 LA	1003290
3-HB 2215 LA	1003291
3-HB 2302 LA	1003292
3-HB 2462 LA	1003293
3-HB 2907 LA	1003294
3-HB 3820 LA	1003295
45X22 X 2385 LP	1003310
45X22 X 4000 LP	1002723
4-HB 1662 LA	1003296
4-HB 1877 LA	1003297
4-HB 2200 LA	1003298
4-HB 2215 LA	1003299
4-HB 2907 LA	1003300
4-HB 3820 LA	1003301
5-HB 2777 LA	1003302
5-HB 3820 LA	1003303
5-HB 4012 LA	1003304
5-HB 6377 LA	1003305
KB 2/5V 1900 LA	1003288
KB 2/5V 2120 LA	1003289
2-HB 1862 LA	1003283
2-HB 1962 LA	1001568
2-HB 2062 LA	1003284
2-HB 3820 LA	1003285
2-HB 4432 LA	1003286
2-HB 4562 LA	1003287
A 2530 LP	1003378
A 2800 LP	1000156
A 3150 LP	1003269
A 3750 LP	1003270
B 2420 LP	1003271
C 1900 LP	1003272
C 2000 LP	1000579
C 2120 LP	1000590
C 2240 LP	1000597
C 2800 LP	1003273
C 2810 LP	1003527
C 3000 LP	1003274
C 3081 LP	1003275
C 3750 LP	1000736
C 4276 LP	1003276
C 4750 LP	1003318
C 7500 LP	1003320
D 2120 LP	1003277
D 3475 LP	1002702
D 3750 LP	1003278

PART NUMBER	OPTIBELT AP
D 4500 LP	1003279
D 5300 LP	1000972
HCM 2010 LA	1003280
SPC 2360 LP	1003281
D 1900 LP	1003282
LAVERDA	
340433129	1000104
340433131	1000106
340433132	1000101
340433134	1003369
340433151	1000124
340433159	1000135
340433179	1000149
340433181	1003379
340433191	1000170
340433198	1000165
340433253	1000231
340433259	1000225
340433260	1000241
340433262	1000244
340433268	1000252
340433270	1000256
340433272	1003430
340433316	1000367
340433405	1000554
340433422	1000606
340433423	1000613
340433446	1000787
340433457	1003833
340433469	1000624
340433475	1000588
340433531	1000950
340433539	1001120
340434138	1001061
340435127	1004072
340435131	1003847
340435147	1003848
340435150	1001422
340435151	1001419
340435152	1001539
340435153	1001424
340435155	1001540
344311117	1003592
344311121	1001591
344311123	1001622
344311124	1001624
344311126	1003608
344311127	1001637
344311129	1001642
344311130	1001652
344311134	1004071
344311139	1001688
344311151	1001717
344311226	1001835
344311227	1001820
344311228	1003630
344311230	1001888
344311233	1001820

# PART NUMBER

PART NUMBER	OPTIBELT AP
344311318	1002000
344311320	1001882
344312128	1003623
3404339850	1001360
3404339860	1001362
3443112310	1003852
3443112320	1001882
E38713	1003369
H138762	1000710
H76136	1000542
H80896	1002570
340433537	1004272
340435146K	1004271
340433141	1000115
340344276	1000271
6247231M1	1004069
344311128	1001637
344311238	1003630
344411229	1001820
344411318	1002000
984909360	1002562
87800127	1002567
344311232	1001882
344311231	1003852
340433985	1001360
340433986	1001362
340435146	1004271
344435155	1001540
340433162	1004273
340433166	1004274
340433195	1004275
340433280	1004276
6247232M1	1004277
6248667M1	1004278
6248658M1	1004279
6248670M1	1004280
28263120	1004281
6248653M1	1004282
344311132	1004283
28263240	1004284
344311240	1004285
344311229	1004286
344311236	1004287
6237302M1	1003038
7061016M1	1004288
344311309	1004289
344311239	1004290
6247944M1	1004291
6247230M1	1004293
7059737M1	1004292
28264254	1004294
340435138	1004295
6247946M1	1004296
28263119	1004297
7061235M1	1004298
7061926M1	1004299
41990027	1004300
340433424	1004842
340433435	1000702

PART NUMBER	OPTIBELT AP
340434140	1000999
344311137	1001679
340435120 K	1001468
LA340433253	1000231
LA340433262	1000244
LA340433405	1000554
LA340433446	1000787
LA340434138	1001061
LA340433539	1001120
LA340433984	1001346
LA340435150	1001422
LA340435153	1001424
LA340435120 K	1001468
LA340435152	1001539
LA340435155	1001540
LA344311121	1001591
LA344311124	1001624
LA344311127	1001637
LA344311128	1001637
LA344311151	1001717
LA344311227	1001820
LA344311233	1001820
LA344311226	1001835
LA344311230	1001888
LA344311318	1002000
LA340433134	1003369
LA340433181	1003379
LA344311117	1003592
LA344311126	1003608
LA344312128	1003623
H81742	No AP
H86259	No AP
<b>MASSEY FERGUSON</b>	
41909000	1003748
41911000	1000143
41912300	1003380
41912400	1003381
41926300	1000230
41929000	1000251
41930200	1000260
41930300	1003426
41933700	1002760
41934800	1002768
41935700	1003447
41936200	1002770
41942100	1000404
41942200	1000410
41950100	1000627
41950400	1003517
41955900	1000704
41958500	1000859
41963900	1000233
41978400	1001725
41978800	1001683
41978900	1001730
41979000	1001632
41979100	1001607
41979600	1003347

PART NUMBER	OPTIBELT AP
41979800	1001990
41979900	1003576
41980900	1001526
41981000	1001539
41981100	1001436
41981200	1001427
41982100	1000582
41982200	1003499
41982400	1003501
41982500	1000585
41983500	1000611
41983600	1000611
41984100	1000655
41985200	1000603
41985300	1003514
41985600	1000693
41986100	1000675
41986300	1000756
41987300	1000815
41987600	1000853
41987900	1000575
41988000	1000698
41988700	1003562
41989200	1000908
41989400	1000911
41990001	1002212
41990009	1002357
41990050	1003600
41990051	1001877
41990068	1001368
41990069	1001378
41990100	1001377
41990400	1003581
41991000	1002346
41991300	1001836
41991700	1001844
41993400	1003633
41998800	1000278
71148120	1002556
71379105	1001170
71385693	1003357
71385801	1003628
71386352	1001900
71387775	1003643
71388712	1000821
71390188	1001877
71390199	1003933
71396754	1003660
71398384	1004135
71398388	1001391
71399505	No AP
71399519	1001148
71403685	1004121
71403721	1002009
71406285	1001961
71406338	1001648
71406339	1003617
71406361	1001645
71418976	1003716

# PART NUMBER



PART NUMBER	OPTIBELT AP
71418978	1003717
71427255	1000801
049880T1	1002562
101102M1	1001662
103319M1	1000692
104072W1	1001171
1051235M1	1000878
111954W1	1001166
1447778M91	1002948
1483884M1	1000677
1603701M1	1001641
1604401M1	1000370
1612891M91	1002431
1612892M91	1002488
1614371M1	1002540
1615254M1	1000765
1615333M1	1000743
1616477M1	1000211
1680230W1	1004118
1686615M91	1002918
1686616M91	1002478
1686883M1	1002534
1687531M1	1002558
1687610M91	1002918
1688216M91	1002945
1688988M1	1002554
1690692M1	1002529
1693745M1	1002581
1693746M1	1002543
1720205M3	1001889
1720255M1	1001871
1720488M1	1000675
1720674M2	1000220
1721710M1	1002096
1722835M1	1003502
1724154M1	1000647
1809095M2	1000070
1855008M1	1000572
186976M1	1002551
222882M2	1000232
227455M1	1000698
227457M1	1000572
227976M1	1000214
227984M1	1000731
227986M2	1000402
228722M1	1000214
228813M3	1000543
230380M1	1000541
230381M1	1003482
233950M1	1003334
240575M2	1002298
259047M91	1000131
2593000W1	1001604
265522M91	1000133
273757M91	1000381
273837M91	1002490
274015M91	1003436
274339M91	1000128
2801859M1	1002571

PART NUMBER	OPTIBELT AP
281560M91	1002782
2834466M1	1003399
284633M91	1003757
3040949M1	1002580
3043153M1	1001399
3043154M1	1001398
31-2449520	1001948
3145238M1	1002584
320551M1	1001063
320593M2	1001361
320595M2	1000540
320596M1	1003412
320623M2	1003438
322768M1	1003482
324872M1	1000215
328656M1	1000527
3370141M1	1001746
3381364M91	1003740
3383044M91	1002485
3386190M91	1002953
3386214M1	1002542
3389525M1	1002534
3412285M2	1002589
3581611M1	1002562
3582952M1	1002549
3582953M91	1002954
3595070M91	1002573
3612115M1	1002547
3612930M1	1002515
3614706M92	1002956
3614715M2	1002539
3616512M91	1002958
3617180M91	1002430
3617184M91	1003957
3619084M91	1002577
3619356M91	1002487
3637306M91	1002960
3712531M1	1002528
3714894M1	1002547
3777681M91	1002961
3777748M2	1002519
3779379M91	1002571
3780061M91	1002950
3780138M91	1002963
3780603M91	1002960
3780604M91	1002962
3780605M91	1002961
3780606M91	1002965
3780607M91	1002944
3780608M91	1002578
3780616M91	1002968
3787792M1	1002623
3789028M1	1002630
3808704M1	1002565
3808705M1	1002486
3808730M1	1002963
3809174M1	1002524
3809175M1	1002546
3810420M1	1002924

PART NUMBER	OPTIBELT AP
3815255M2	1002567
3815256M1	1002556
3815257M1	1002960
3817582M1	1002944
401110M1	1001160
402604M1	1003390
402605M1	1003428
402606M1	1003523
402607M1	1003515
403041M1	1000206
403071M1	1003432
410195M1	1002281
410959M1	1003512
412074M1	1003402
412236M1	1003530
412237M1	1000886
412333M1	1003574
412399M1	1000557
417468M1	1003397
417972M1	1000885
417974M1	1000651
418192M1	1000547
4271806M1	1002624
4272496M1	1002553
4273187M1	1002656
4273188M1	1002658
4273270M1	1002628
4274692M91	1002971
4274693M91	1002969
4275520M1	1002662
4275545M3	1002613
4275784M1	1002622
4276375M1	1002627
4276808M1	1002626
4277220M1	1002625
487802M2	1002550
5015577M1	1003691
5016260M1	1002524
509572M1	1003707
513133M1	1000069
513833M1	1003725
517344M2	1002428
517456M1	1003720
517951M91	1002491
518506M92	1002482
521110M1	1002531
521370M1	1002546
524413M92	1002972
529900M91	1000029
529964M1	1002534
531371M1	1002558
532779M92	1002480
619317M2	1000563
619327M1	1004086
619595M1	1000536
621258M1	1000346
621259M1	1000547
621261M1	1000284
621262M1	1003334

# PART NUMBER

PART NUMBER	OPTIBELT AP
621588M1	1000668
782850M2	1000537
784170M2	1000425
784796M2	1003546
784797M2	1000214
785585M3	1004096
785810M1	1000378
789853M1	1001403
789930M1	1002617
789931M1	1002616
789967M1	1000986
795514M4	1000264
795582M2	1000249
826960M1	1001015
828729M1	1002531
832490M1	1001277
832538M1	1003431
832789M3	1001442
832832M1	1000688
832877M1	1000232
832878M1	1000596
832906M1	1000758
833768M1	1001402
833854M2	1000335
833855M1	1000419
833860M1	1000820
833862M3	1003597
833863M1	1001400
833865M1	1003665
833867M1	1000119
833868M2	1001483
833871M1	1001747
833872M1	1000762
833873M1	1001568
833874M1	1001848
833962M1	1000673
834058M1	1000598
834139M1	1000567
834140M1	1000734
834175M1	1001842
834176M1	1003627
834190M1	1000597
834332M1	1000304
834492M2	1000211
842935M1	1003482
843045M1	1002543
843198M1	1000063
843310M1	1000429
843313M1	1001016
843324M1	1000804
843732M2	1001443
843737M1	1000216
843747M1	1000827
843760M1	1000803
843948M1	1001451
844091M1	1001445
844306M1	1000116
890982M1	1000057
893575M1	1000060

PART NUMBER	OPTIBELT AP
905920M1	1001450
905980M1	1001552
912877M1	1001181
966427M1	1000051
1682684M2	1002548
71406286	1001831
71418984	1004614
71388216	1004622
040560T1	1002561
6201602M91	1002963
6203323M91	1002965
6214645M1	1002588
036720T1	1002590
41987800	1000620
842809M1	1000700
D41929000	1000251
D41986100	1000675
D41981200	1001427
D41981100	1001436
D41980900	1001526
905921M1	1004743
320496M3	No AP
3786922M91	No AP
402608M3	No AP
418232M1	No AP
793863M1	No AP
833856M1	No AP
833858M4	No AP
844077M1	No AP
<b>MDW</b>	
72049753	1001317
770000827	1004116
770000482	1001630
020797321	1001663
770000730	1001718
770002340	1004531
770001153	1001724
60067613	1001516
770000466	1004887
<b>MENGELE</b>	
04-109135	1002019
98-006272	1003465
98-011048	1000466
98-014367	1000206
98-017686	1000473
98-017967	1002214
98-018167	1002452
98-020849	1003466
98-021123	1002562
98-022200	1000136
98-022265	1000472
98-022731	1000138
98-023422	1003625
98-024340	1000442
98-025521	1002045
98-026937	1003387
98-028264	1000473

PART NUMBER	OPTIBELT AP
98-028266	1000466
98-028267	1000469
98-028268	1000470
98-028271	1000458
98-028534	1001252
98-029383	1002942
98-029384	1002487
98-031590	1001847
98-031801	1001855
98-031803	1001899
98-036045	1001896
98-036276	1001258
98-036317	1001010
98-039776	1001265
98-039955	1001895
98-041405	1000562
98-041414	1001550
98-041435	1002021
98-041779	1001897
98-042197	1001257
98-042202	1003035
98-042380	1002301
98-042442	1001880
98-042619	1002042
98-043775	1001908
98-043776	1001904
98-043777	1001906
98-043929	1000559
<b>NEW HOLLAND</b>	
336784	1001506
445930	1002074
448794	1000756
452023	1002976
577240	1002565
615790	1004108
618040	1004117
621367	1004120
624650	1002841
626654	1002963
626657	1002568
649035	1004151
682008	1004122
710752	1004167
715785	1004170
716254	No AP
747177	1002582
768340	1004158
773255	1002582
773300	1004168
774747	1001633
797979	1004152
849514	1004169
855676	1003746
859063	1004164
919739	1001136
9502654	1001135
9513136	1004110
9515075	1001428

# PART NUMBER



PART NUMBER	OPTIBELT AP
9515076	1001416
9593400	1002029
9604713	1004126
9609607	1000230
9613963	1004140
9818704	1000074
9835816	1002588
9838606	1000654
9850782	1001491
80066232	1000690
80186347	1003809
80230043	1003400
80230057	1000603
80230059	1000654
80230060	1003534
80230077	1001489
80230078	1001509
80230103	1000881
80230108	1003452
80230164	1000622
80321559	1001512
80323413	1000577
80323646	1001949
80326298	1003489
80327040	1002267
80330204	1000243
80330715	1000726
80333255	1000775
80333958	1000715
80334065	1001403
80336386	1000027
80336426	1000020
80336784	1001506
80337415	1000625
80350236	1003640
80356024	1001489
80356025	1001525
80378989	1002821
80386155	1000022
80387460	1001537
80387469	1000700
80388280	1001410
80391143	1003838
80391650	1001977
80393326	1003323
80395955	1000555
80396750	1002880
80397297	1001858
80410896	1000567
80422731	1000696
80424563	1001765
80427456	1003351
80431784	1000328
80432642	1003746
80433639	1000237
80433746	1000405
80434046	1000657
80434047	1001602
80434160	No AP

PART NUMBER	OPTIBELT AP
80434222	1001635
80436304	1002482
80439495	1000173
80439496	1002609
80439832	1001415
80440780	No AP
80443634	1002543
80443636	1002935
80446780	1000750
80447031	1001872
80448794	1000756
80451481	1001946
80453268	1000319
80455865	1001954
80457309	1000181
80605529	1000366
80743877	1003349
80747177	1002582
80748003	1002974
80750166	1001242
80750290	1002008
80750318	1001134
80754165	1002415
80754285	1000594
80754388	1003341
80754389	1003339
80755808	1001488
80825013	1001562
80913151	1003429
80913153	1000081
80919739	1001136
80922872	1003667
80922911	1002004
80923019	1000166
82850750	1002636
82850751	1002637
84000189	1000666
84000191	1003616
84000838	1002603
84004444	1001657
84005417	1001655
84005860	1002636
84007307	1002605
84012975	1002087
84015531	1000601
84015852	1000231
84017621	1001702
84017742	1001167
84021588	1000083
84021590	1000082
84022715	No AP
84022807	1001132
84023277	1001132
84023278	1001133
84026761	1002746
84035748	1001316
84041518	1002608
84045256	1000638
84056913	1000265

PART NUMBER	OPTIBELT AP
84057085	1000175
84057392	1003337
84057393	1001581
84057482	1000400
84057710	1002690
84057874	1000699
84057914	1003844
84058339	1000200
84061279	1001880
84061293	1001634
84061463	1004160
84061465	1002586
84061615	1001884
84072421	1002036
84072772	1001237
84072815	1001952
84073276	1000340
84073457	1000256
84073933	1000566
84073979	1001421
84075345	1001636
84075635	1001687
84075955	1003347
84076421	1001705
84320963	1001646
84334995	1004196
84432785	1000680
84434260	1001714
84434295	1001645
84435035	1001644
84446792	1003326
84448591	1000657
84452112	1004114
84452153	1004044
84457079	1001583
84459056	1004161
84462590	1000653
84607712	1001850
84607713	1001853
84817623	1001954
84817626	1002579
84817627	1001135
84817628	1003345
84817629	1001557
84817630	1002606
84817631	1002006
84817632	1003639
84817635	1000601
84817636	1003404
84817638	1003807
84817639	1002608
84817670	1002969
84818007	1002621
84818008	1004045
84971217	1001782
84981586	1001720
84982278	1001697
84989965	1000169
84991234	1001922

# PART NUMBER

PART NUMBER	OPTIBELT AP
84991836	1000653
84993120	1002011
86503087	1004123
86514256	1004119
86518568	No AP
86566287	1000532
86589482	1001914
87011585	1001636
87053803	No AP
87284244	1004162
87309962	1002663
87309963	1002639
87315599	1004066
87319821	1004066
87325684	1004179
87339998	1004042
87366407	1003971
87374615	1004049
87403144	1002676
87403145	1002673
87437226	1003972
87441270	1002681
87441272	1002679
87521887	1000341
87526022	1004128
87535206	1003727
87545651	1004150
87545653	1004148
87546479	1001636
87557181	1004139
87580097	1001978
87580099	1001627
87580100	1004127
87621086	1001537
87636309	1004115
87664428	1004111
87676816	No AP
87800858	1002663
87802822	1002664
87840341	1002647
89502654	1001135
89512971	1003801
89513984	1000631
89514310	1000152
89593418	No AP
89593440	1000816
89593464	1004077
89814069	1001557
89817374	1001876
89817487	1004471
89817488	1001780
89818704	1000074
89818705	1000079
89831515	No AP
89832601	1001288
89835120	1001781
89837412	1000573
89838606	1000654
89839375	1000774

PART NUMBER	OPTIBELT AP
89850782	1001491
325289A1	1003973
K68073	1002465
87324567	1002575
4809680	1002460
5186232	1002460
5088081	1002462
4796327	1002461
5154152	1002512
47137503	1002923
98490935	1002972
98473705	1002467
4796328	1002942
87643267	1002942
500369112	1002465
5140009	1002455
5186233	1004255
5094418	1004254
87282333	1003244
605529	1000366
87357455	1000990
4899178	1003141
87531428	1003198
87556830	1004157
47131754	1004685
337415	1000625
87301964	1004319
259346	1004159
80259346	1004159
330204	1000243
386155	1000022
750290	1002008
80391142	1003838
89515075	1001428
89515076	1001416
89818873	1003662
89835815	1002588
80230056	1003232
80437033	1002878
80230045	1001568
80411543	1003662
80424318	1001467
80919681	1001602
84790356	1004472
89514989	1001679
89817454	1000081
89832309	1001861
89835816	1002588
89850770	1003992
500371653	1004473
80230046	1004468
80230061	1000717
80230073	1000904
80353584	1000734
80384397	1004896
80399058	1002599
80362500	1002788
80445640	1000555
80371222	1002547

PART NUMBER	OPTIBELT AP
<b>PÖTTINGER</b>	
460013	1000359
460047	1002058
460048	1002323
460055	1002403
460056	1003694
460057	1002062
460061	1002066
460062	1002064
460063	1002073
460066	1002068
460184	1002146
460186	1003676
460188	1002149
460192	1002176
460194	1002827
460195	1002848
460196	1003764
460197	1003417
460198	1003680
460199	1002181
460201	1000185
460212	1003431
460216	1002818
460217	1002850
460218	1000205
460222	1000243
460223	1000261
460231	1000184
460253	1000500
460259	1002312
460408	1001130
460409	1002291
460411	1000329
460412	1000340
460413	1000374
460420	1002311
460452	1001984
460.000 0026	1003424
460453	1001985
<b>RENAULT AGRICULTURE</b>	
7701029709	1004878
<b>ROSTSELMACH</b>	
6201005	1000204
6201006	1002701
6201015	1001259
6201016	1001986
6201017	1000835
6201022	1000729
6201023	1000830
6201028	1000217
6201029	1001661
6201080	1002300
6201081	1002518
6201083	1002715
6201084	1002703

# PART NUMBER



PART NUMBER	OPTIBELT AP
6201085	1002714
6201086	1002716
6201087	1002719
6201088	1002704
6201089	1002705
6201091	1003314
6201094	1002007
6201096	1001082
6201097	1000239
6201166	1001193
6201195	1002014
6201196	1001301
6201197	1002236
6201246	1001291
6201247	1001327
6201249	1001306
6201251	1003329
6201253	1002220
6201254	1001060
6201255	1002723
6201256	1000773
6201258	1001203
6201260	1002252
6201263	1002213
6201264	1001962
6201265	1002716
6201266	1002721
6201269	1003778
6201270	1003330
6201271	1002226
6201272	1002185
6201273	1001003
6201275	1003315
6201277	1002232
6201290	1002702
6201297	1002229
6201298	1003688
6201315	1000342
6201316	1001609
6201317	1002706
6201318	1002707
6201319	1002718
6201320	1002713
6201322	1002712
6201324	1002724
6201325	1003322
6201326	1003317
6201327	1002538
6201328	1002248
6201329	1002725
6201330	1003323
6201335	1003331
6201339	1003680
6201340	1002708
6201341	1002726
6201342	1003319
6201343	1000579
6201344	1003324
6201345	1000608

PART NUMBER	OPTIBELT AP
6201346	1000636
6201347	1000722
6201348	1002730
6201349	1002728
6201350	1002729
6201351	1001081
6201352	1002315
6201353	1000970
6201354	1000972
6201355	1000303
6201356	1003325
6201357	1002700
6201358	1002727
6201363	1001617
6201371	1002529
6201373	1001102
6201375	1001700
6201376	1003005
6201377	1001305
6201378	1001673
6201379	1003751
6201380	1001963
6201381	1000114
6201382	1001575
6201383	1002709
6201384	1003771
6201387	1002121
6201392	1001654
6201394	1001998
6201396	1002135
6201397	1001582
6201399	1001921
6201400	1001663
6201401	1000174
6201404	1001638
6201405	1000226
6201406	1000171
6201408	1002711
6201411	1002358
6201412	1003327
6201413	1002654
6201414	1002559
6201415	1002717
6201416	1002731
6201417	1002732
6201418	1002734
6201419	1001604
6201420	1002705
6201421	1002142
6201422	1002733
6201424	1002710
6201426	1003933
6201393	1004311
6201461	1002537
6201437	1004703
6201428	1004523
6201432	1004895
6201403	1001324

PART NUMBER	OPTIBELT AP
<b>SAMPO</b>	
1472227	1004159
0613116	1000104
0613122	1003818
0613124	1000115
0613126	1002059
0613128	1000118
0614115	1003394
0614136	1000275
0614148	1000325
0614150	1000339
0614152	1000343
0614212	1000235
0614215	1002304
0614217	1003839
0614222	1003840
0614224	1000257
0614225	1003834
0614226	1003841
0614227	1000269
0614242	1000300
0614246	1000313
0614260	1000370
0615108	1000548
0615109	1003820
0615116	1000575
0615124	1003821
0615128	1000645
0615129	1000664
0615135	1000652
0615146	1000781
0615147	1000803
0615151	1003556
0615159	1000755
0615168	1003822
0615170	1000622
0615173	1003516
0615179	1000669
0615184	1000745
0619054	1001590
0619065	1001633
0619081	1001616
0619080	1001839
0619083	1003825
0619085	1003854
0619090	1001898
0619168	1003823
0619169	1001502
0619179	1001505
0619191	1003944
0619192	1003824
R634644	1000339
R634650A	1003821
R634655	1000803
R644247A	1000325
R652307A	1000652
R680791	1003823
R680812B	1001898

# PART NUMBER

PART NUMBER	OPTIBELT AP
R694252A	1002304
R694253	1000645
R694254	1003834
R694255A	1003820
R694256	1000745
R694263	1003841
R694943	1003818
R696665	1003822
R698062	1003842
R698063	1003839
R700327	1003840
R700328	1000235
R701183	1003824
R706495	1000257
O614125	1000238
O619175	1004067
O615130	1000646
O61533	1000698
O619087	1004566
O619185	1004742
O619062	1004867
O619170	1004877
O615139	1004894
O614166	No AP
O619070	No AP
<b>SISU Diesel</b>	
684020550	No AP
V684020550	No AP
<b>STOLL</b>	
1592600	1004239
0071480	1004228
0204480	1004229
0204510	1004234
0401820	1004243
0402980	1004236
0425540	1003501
0440800	1003552
0441330	1004036
0441770	1001059
0441840	1004221
0441860	1004248
0443880	1004230
0445510	1003677
0451680	1002153
0453850	1002117
0455990	1004233
0456660	1003680
0457280	1002166
0462560	1004235
0462680	1004246
0464590	1004222
0465180	1004242
0465510	1004219
0465530	1000602
0465850	1004218
0465860	1000245
0467010	1004227

PART NUMBER	OPTIBELT AP
0467390	1004223
0467640	1004225
0469250	1004247
0469800	1004244
0469810	1004250
0474850	1004224
0476430	1000541
0476440	1004232
0479100	1004249
0480490	1004226
0488950	1004245
0496030	1004231
1361-2406	1003484
1361-3202	1000263
1361-3404	1000587
1361-4101	1000272
1361-4401	1000590
1361-4402	1000591
1361-4403	1000602
1361-5202	1000300
1361-5402	1000609
1361-5404	1000624
1361-5405	1000625
1361-5501	1000940
1361-5502	1000939
1361-6102	1003454
1361-6401	1000670
1361-6402	1000643
1361-6404	1000652
1361-6405	1000659
1361-6406	1000628
1361-6407	1000633
1361-6410	1000647
1361-6501	1000946
1361-7403	1000703
1361-7502	1000949
1361-8110	1000424
1361-8300	1003555
1361-8303	1003553
1361-8304	1000807
1361-8307	1003549
1361-8308	1000777
1361-8310	1000782
1361-8311	1000779
1361-8401	1000719
1361-8403	1000706
1361-8503	1004205
1361-8505	1004203
1361-8507	1004206
1361-8508	1000967
1361-8509	1000966
1361-8511	1000975
1361-8512	1000976
1361-9601	1000894
1361-9605	1000921
1361-9608	1000932
1361-9614	1004202
1361-9615	1001034
1361-9618	1000974

PART NUMBER	OPTIBELT AP
1361-9703	1002127
1361-9706	1002169
1361-9707	1003677
1361-9709	1002170
1361-9715	1004216
1361-9718	1004215
1361-9733	1002364
1361-9737	1002185
1361-9804	1002126
1361-9805	1002122
1361-9901	1002217
1361-9906	1003316
1361-9908	1002224
1362-1001	1003048
1362-1002	1003050
1362-1003	1003678
1362-1004	1002134
1362-1005	1002326
1362-1006	1001285
1362-1007	1003049
1362-1008	1000219
1362-1009	1002156
1362-1010	1004304
1362-1011	1003255
1362-1012	1002116
1362-1013	1002392
1362-1014	1002394
1362-1015	1004211
1362-1016	1002164
1362-1017	1004305
1362-1018	1004208
1362-1205	1003761
1362-1207	1002836
1362-1208	1002810
1362-1209	1000234
1362-1210	1004220
1362-2106	1002838
1362-2202	1002840
1362-2405	1000549
1362-2407	1000551
1362-3105	1002787
1362-3205	1002842
1362-4105	1002890
1362-6101	1002769
1362-8304	1004200
1362-8408	1002891
1362-8505	1002912
1362-9702	1003053
1362-9704	1004209
1362-9705	1002130
1362-9707	1004210
1362-9708	1004212
1362-9713	1003054
1362-9716	1002379
1362-9719	1002397
1362-9720	1002165
1362-9721	1003055
1362-9722	1002378
1362-9723	1002387





# PROBLEMS – CAUSES – REMEDIES

Competency in drive technology

## OPTIBELT Service Management

The best machine is of little value if it is not operated efficiently. The main objective has to be the optimisation of existing power drives.

The OPTIBELT Service Management offers a broad range of technologically demanding products. Service devices, thematic expert seminars and, last but not least, customised software solutions for drive design and optimisation complete the high-tech segment of OPTIBELT.

### **The operational life is of essential importance**





Half of all drives achieve only between 50 to 70 percent of the estimated operational life; about 20 percent achieve a longer operational life whereas about a third of all drives only achieve 10 to 20 percent of the estimated time. The causes of drive problems are diverse. The biggest problem by far is improper maintenance of the drive; this applies to approx. 40 percent of all cases. An incorrect installation of the belts or the pulleys causes problems for 20 percent of the drives; the same percentage applies to negative external influences as the cause for drive problems. Furthermore, about 12 percent of the problems are due to an incorrect drive design and 4 percent each due to defective drive elements and improper storage or handling of the drive belts.

### **Optimise drives in theory and practice**

Cost reductions can easily and quickly be achieved via simple but highly efficient tools. Simply use the technical equipment by OPTIBELT for trouble-free operation of the individual installation.

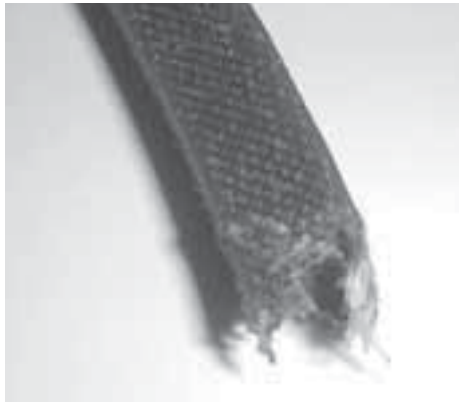

# PROBLEMS – CAUSES – REMEDIES

## V-BELTS

PROBLEM	POSSIBLE CAUSES	REMEDIES
	<p><b>Belt breaks after short running period (belt torn)</b></p> <ul style="list-style-type: none"> <li>Forceful mounting, therefore, damaging the tension cord</li> <li>Drive blocked</li> <li>Ingress of foreign matter during operation</li> <li>Drive underdimensioned, insufficient number of belts</li> </ul>	<ul style="list-style-type: none"> <li>Apply unforced mounting according to instructions</li> <li>Remove the cause</li> <li>Fit a guard</li> <li>Check drive conditions and remachine</li> </ul>
	<p><b>Excessive wear on belt edges</b></p> <ul style="list-style-type: none"> <li>Tension too low</li> <li>Starting torque too high</li> <li>Worn pulley grooves</li> <li>Wrong belt/groove section</li> <li>Wrong groove angle</li> <li>Pulleys do not align</li> <li>Small pulley diameter below recommended minimum</li> </ul>	<ul style="list-style-type: none"> <li>Check tension and retension</li> <li>Check drive conditions and remachine</li> <li>Replace pulleys</li> <li>Adjust belt and groove sections</li> <li>Remachine or replace pulleys</li> <li>Align pulleys</li> <li>Increase pulley diameter (new drive design), use OPTIBELT special execution or OPTIBELT SUPER X-POWER M=S (SUPER TX)</li> </ul>
 	<p><b>Cuts and splits at the base of the belt (brittleness)</b></p> <ul style="list-style-type: none"> <li>Outside idler pulley in use the arrangement and diameter of which does not comply with our recommendations</li> <li>Abnormal belt slip</li> <li>Pulley diameter too small</li> <li>Ambient temperature too high</li> <li>Ambient temperature too low</li> <li>Chemical influences</li> </ul>	<ul style="list-style-type: none"> <li>Remove protrusions or realign drive</li> <li>Note OPTIBELT recommendations, e.g. increase diameter. Increase size of existing idler. Use OPTIBELT RED POWER 3 or OPTIBELT special execution.</li> <li>Retension drive according to installation instructions. Check drive conditions and redesign, if necessary. Redesign using minimum pulley diameters.</li> <li>Use OPTIBELT special execution or OPTIBELT SUPER X-POWER M=S (SUPER TX)</li> <li>Ensure good ventilation, protect belts from direct heat. Use OPTIBELT XHR special execution (extra heat resistant) or use OPTIBELT SUPER X-POWER M=S (SUPER TX) or belt with aramid cord construction.</li> <li>Warm area surrounding drive and belt before use. Use OPTIBELT special execution.</li> <li>Protect drive from contamination. Use OPTIBELT special execution.</li> </ul>

# PROBLEMS – CAUSES – REMEDIES



## V-BELTS

PROBLEM	POSSIBLE CAUSES	REMEDIES
	<p><b>Belt swelling or softening</b></p> <p>Contamination by oil, grease, chemicals</p>	<p>Protect drive from contamination. Use raw edge OPTIBELT SUPER X-POWER M=S (SUPER TX) or special execution "05". Clean pulley grooves with petrol or alcohol before using new belts!</p>
	<p><b>Belts turn over</b></p> <p>Wrong belt/groove section</p> <p>Pulleys do not align</p> <p>Pulley grooves severely worn</p> <p>Tension too low</p> <p>Excessive vibrations</p> <p>Foreign matter in pulley grooves</p>	<p>Realign belt and groove section correctly</p> <p>Realign pulleys</p> <p>Replace pulleys</p> <p>Retension drive</p> <p>Use inside idler pulley on drive slack side or OPTIBELT KB kraftbands</p> <p>Remove foreign matter and protect drive</p>

If further problems arise, contact our engineers from the applications engineering dept. Detailed technical data are necessary for specific assistance.

# PROBLEMS – CAUSES – REMEDIES

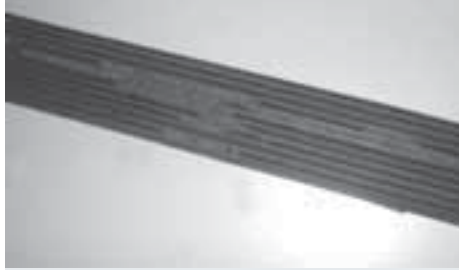

## RIBBED BELTS

PROBLEM	POSSIBLE CAUSES	REMEDIES
	<p><b>Unusual wear and tear of ribs</b></p> <ul style="list-style-type: none"> <li>Tension too low</li> <li>Ingress of foreign matter during operation</li> <li>Pulleys do not align</li> <li>Pulleys defective</li> <li>Wrong rib/pulley section</li> </ul>	<ul style="list-style-type: none"> <li>Correct tension</li> <li>Fit a guard</li> <li>Align pulleys</li> <li>Remachine or replace pulleys</li> <li>Align rib and pulley section</li> </ul>
	<p><b>Break of ribbed belts after short running time (belts torn)</b></p> <ul style="list-style-type: none"> <li>Ribbed belt slips or catches on protruding parts</li> <li>Drive blocked</li> <li>Drive overloaded</li> <li>Effects of oil, grease, chemicals</li> </ul>	<ul style="list-style-type: none"> <li>Remove protruding parts; realign drive</li> <li>Remove cause</li> <li>Check drive conditions and redesign</li> <li>Protect drive from environmental influences</li> </ul>
	<p><b>Cuts and splits in the ribs (brittleness)</b></p> <ul style="list-style-type: none"> <li>Effects of an outside idler pulley the arrangement and diameter of which does not comply with our recommendations</li> <li>Pulley diameter too small</li> <li>Ambient temperature too high</li> <li>Ambient temperature too low</li> <li>Abnormal belt slip</li> </ul>	<ul style="list-style-type: none"> <li>Comply with OPTIBELT recommendations, e.g. increase diameter; use an inside idler pulley on the drive slack side</li> <li>Ensure minimum pulley diameter</li> <li>Remove source of heat, protect belts from direct heat. Improve air ventilation.</li> <li>Warm up ribbed belt before use</li> <li>Retension drive according to installation instructions. Check drive conditions and redesign if necessary.</li> </ul>
	<ul style="list-style-type: none"> <li>Chemical influences</li> </ul>	<ul style="list-style-type: none"> <li>Protect drive from contamination</li> </ul>

If further problems arise, contact our engineers from the applications engineering dept. Detailed technical data are necessary for specific assistance.

# PROBLEMS – CAUSES – REMEDIES

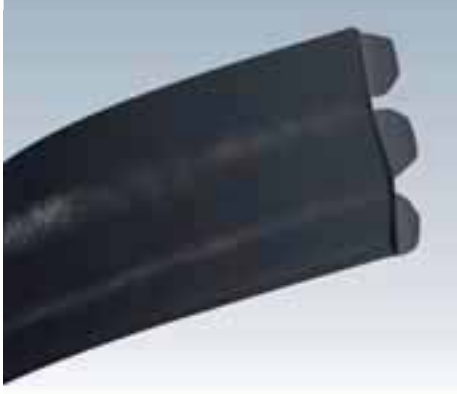
## KRAFTBANDS

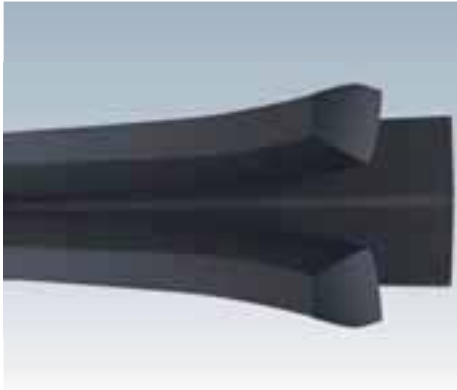
PROBLEM	POSSIBLE CAUSES	REMEDIES
	<p><b>Frayed, worn or damaged top of tie-band</b></p> <ul style="list-style-type: none"> <li>Interference with guard</li> <li>Backside idler malfunction or damaged</li> </ul>	<ul style="list-style-type: none"> <li>Check guard</li> <li>Repair or replace backside idler</li> </ul>
	<p><b>Multiple belt comes off drive</b></p> <ul style="list-style-type: none"> <li>Debris in pulleys</li> </ul>	<ul style="list-style-type: none"> <li>Clean grooves. Use single belts to prevent debris from being trapped in grooves.</li> </ul>
	<p><b>One or more ribs run outside of pulley</b></p> <ul style="list-style-type: none"> <li>Misalignment</li> <li>Undertensioned</li> </ul>	<ul style="list-style-type: none"> <li>Realign drive</li> <li>Retension</li> </ul>
	<p><b>Tie-band separation</b></p> <ul style="list-style-type: none"> <li>Worn pulleys</li> <li>Improper groove spacing</li> </ul>	<ul style="list-style-type: none"> <li>Replace pulleys</li> <li>Use standard groove pulleys</li> </ul>

# NOTES

# NOTES



# NOTES

# NOTES

Owner of any and all copyrights and intellectual property rights as well as other rights of use and exploitation:  
Arntz OPTIBELT Group, Höxter/Germany. Any use, exploitation, reproduction, and any transfer to third parties by any means shall  
require the prior written approval of the Arntz OPTIBELT Group, Höxter/Germany.

Print: 414587/0613Hux

GB

D

Abbreviations	Abkürzungserklärung
1. AND 2. SEPARATOR CYLINDER	1. UND 2. ZYLINDER RESTKORNABSCHIEDUNG
115=CASE 6 CYL 411, WATER PUMP (Prior to)	115=CASE 6 CYL 411, WASSERPUMPE (FRÜHERE MODELLE - BIS)
1174 - FOR POSH-TORQUE GROUND SPEED DRIVE	1174 - FÜR POSH-TORQUE ANTRIEB HÖCHSTGESCHWINDIGKEIT
1174 ONLY AC WITH INTEGRATED CONDENSER COOLING	NUR 1174 - AC MIT INTEGRIERTEM KÜHLUNGSKONDENSATOR
130=CASE 4 CYL 273, WATER PUMP (Prior to)	130=CASE 4 CYL 273, WASSERPUMPE (FRÜHERE MODELLE - BIS)
1ST AND 2ND SEPARATOR DRUM	1. UND 2. TROMMEL RESTKORNABSCHIEDUNG
1ST EACH SPREADER BLOWER	1ST JE SPREUVERTEILER LÜFTER
1ST STAGE BLOWER	1. STUFE GEBLÄSE
1ST STAGE CHOPPER	1. STUFE HÄCKSLER
1ST STAGE CLEANING	1. STUFE REINIGUNG
1ST STAGE CUTTERBAR	1. STUFE SCHNEIDLEISTE
1ST STAGE HYBRID	1. STUFE HYBRID
1ST STAGE RADIATOR SCREEN	1. STUFE LÜFTER GITTER
268 C.I. / 258 C.I., FAN W/AIR	268 C.I. / 258 C.I., LÜFTER W/LUFT
2HC DRIVE BESIDE STRAW ELEVATOR	2HC ANTRIEB - NEBEN STROHFÖRDERER
2ND STAGE CHOPPER	2. STUFE HÄCKSLER
2ND STAGE CUTTERBAR WITHOUT VARIABLE SPEED	2. STUFE SCHNEIDWERK OHNE VARIABLEN ANTRIEB
2X BY MAIZE PICKET	2X BY MAIS PICKER (- BIS NR. 15606082)
3 CYL, 152 - 4 CYL, 134/145, FAN (GAS) (DELUXE & VINEYARD)	3 CYL, 152 - 4 CYL, 134/145, LÜFTER (GAS) (DELUXE & VINEYARD)
3 CYL, 152 - 4 CYL, 134/145, FAN (GAS) (ORCHARD ONLY)	3 CYL, 152 - 4 CYL, 134/145, LÜFTER (GAS) (NUR ORCHARD)
3RD STAGE CHOPPER	3. STUFE HÄCKSLER
4 CYL, 276, DRIVE W/AIR CONDITIONER	4 CYL, 276, ANTRIEB W/KLIMATISIERUNG
6 CYL, 456, FAN	6 CYL, 456, LÜFTER
8. SEPARATOR DRUM	8. TROMMEL RESTKORNABSCHIEDUNG
ACCELERATOR	BESCHLEUNIGER
AGITATOR DRIVE (FRONT)	MISCHERANTRIEB (VORN)
AIR ASPIRATOR	LUFT ABSCHNECKE
AIR COMPRESSOR - BLOW-OFF SYSTEM	KOMPRESSOR - BLOW-OFF SYSTEM
AIR CONDITION COMPRESSOR	KLIMATISIERUNG KOMPRESSOR
AIR CONDITIONER UNIT : MOUNTING GROUP - WITHOUT HEATING	KLIMATISIERUNG - OHNE HEIZUNG
AIR EXHAUST	LUFTAUSLASS
AIR FILTER	LUFTFILTER
AIR INTAKE	LUFTEINLASS
AT 4G - CHAIN DRIVE	BEI 4G - ANTRIEB KETTE
AT 6G - TRANSMISSION	BEI 6G - TRANSMISSION
AT CHAFF SPREADER	SPREUVERTEILER
AT CHAFF, STRAW- AND RADIAL SPREADER	BEI SPREU-, STROH- UND RADIALVERTEILER
AT CORN	BEI KORN
AT GRAIN	BEI GETREIDE
AT HIGH - LOW SPEED RANGE TRANSMISSION	BEI HOHER / NIEDRIGER ÜBERTRAGUNGSGESCHWINDIGKEIT
AT HYDRAULIC GROUND DRIVE	BEI HYDRAULISCHER HAUPTANTRIEB
AT MERCEDES OM 366 LA WITH HYDRAULIC GROUND DRIVE	BEI MERCEDES OM 366 LA MIT HYDRAULISCHEM HAUPTANTRIEB
AT MERCEDES OM 366 LA WITH MECHANICAL GROUND DRIVE	BEI MERCEDES OM 366 LA MIT MECHANISCHEM HAUPTANTRIEB
AT SPREADER FAN	BEI RADIALVERTEILER
AUGER - LOWER RETURN AUGER (GRAIN)	FÖRDERSCHECKE -RÜCKLAUFSCHECKE (GETREIDE)
AUGER AND KNIFE DRIVE (102)	FÖRDERSCHECKE UND MESSERANTRIEB (102)
AUGER BOTTOM GRAIN TANK	FÖRDERSCHECKE GETREIDETANK BODEN
AUGER DRIVE TAILINGS AND GRAIN	ANTRIEB FÖRDERSCHECKE ABRAUM UND GETREIDE
AUXILIARY CYLINDER (SLINGER)	HILFS-ZYLINDER (SLINGER)
AUXILIARY PUMP DRIVE	ANTRIEB HILFSPUMPE
AWNER SHAFT	ENTGRANNERWELLE
BALER	BALLENPRESSE
BAR CONTROL	STEUERLEISTE
BEATER	WENDETROMMEL
CAT 8 CYL, 573/636/636/636, AUXILIARY HYDRAULICS	CAT 8 CYL, 573/636/636/636, HILFSHYDRAULIK
CENTER SHAFT	MITTLERE WELLE
CENTRIFUGAL SEPARATOR	VORRICHTUNG ABSCHIEDENZENTRIFUGE
CHAFF SPREADER	SPREUVERTEILER
CLEAN GRAIN ELEVATOR	FÖRDERER, FÜR GEREINIGTES GETREIDE
CLUTCH GRAIN TANK	KUPPLUNG GETREIDETANK

GB

D

Abbreviations	Abkürzungserklärung
CONDENSER FAN	KÜHLUNGLÜFTER
CONDENSER ROTARY BLADE	KÜHLER MESSERKREISEL
CONVERTER DRIVE	TRANSFORMATOR ANTRIEB
CONVEYOR SHAFT 1306 MM	FÖRDERWELLE 1306 MM
CORN CRACKER DRIVE	CORN CRACKERANTRIEB
CORN PICKER FOLDING	KORNPFLÜCKER FOLDING
COUNTER DRIVE	ANTRIEB VORLEGEWELLE
CRACKER DRIVE / TENSIONING DEVICE BIG X 1000	ANTRIEB CRACKER / SPANNELEMENT BIG X 1000
CRANK PULLEY	KURBELWELLENSCHEIBE
CRANKSHAFT	KURBELWELLE
CRUSHER DRIVE	ANTRIEB BRECHER
CUTTING DRUM	SCHNEIDETROMMEL
CUTTING MECHANICAL BY 3.0 M	SCHNEIDEMECHANIK VON 3.0 M
CUTTING TABLE	SCHNEIDTISCH
CUTTING UNIT DRIVE	ANTRIEB SCHNEIDEINHEIT
CUTTING UNIT KNIFE	SCHNEIDEINHEIT MESSER
CYLINDER DRIVE	ZYLINDER ANTRIEB
DEFLECTOR DRUM	DEFLECTOR TROMMEL
DISCHARGE AUGER	FÖRDERSCHECKE
DISPOSAL SHAFT DRIVE	ANTRIEB ÜBERGABE
DRAPER TABLE	SCHNEIDWERKSTISCH
DRIVE - VARIATOR	ANTRIEB - VARIATOR
DRIVING GEAR	ANTREIBENDES GETRIEBE
DUST - SCREEN BELT	STAUB - SIEB RIEMEN
DUST EXTRACTOR	STAUBABZUG
DUST REMOVING FAN	STAUB - SIEB LÜFTER
ECCENTRIC DRIVE	EXZENTERWELLE
ELEVATOR SHAKER GRAIN	FÖRDERER, - GETREIDESCHÜTLER
EQUIPMENT (MAIZE)	AUSRÜSTUNG (MAIS)
EXTENSION COUNTERSHAFT	VERLÄNGERUNG VORLEGEWELLE
FAN DRIVE FOR OM 457 LA	ANTRIEB LÜFTER FÜR OM 457 LA
FAN INTERMEDIATE DRIVE	ANTRIEB ZWISCHENLÜFTER
FAN JACKSHAFT DRIVE	ANTRIEB LÜFTER VORLEGE
FAN MILL VARIABLE SPEED	MÜHLENANTRIEB STUFENLOS
FANNING MILL	LÜFTER FÜR MÜHLE
FEED ACCELERATOR, STANDARD SPEED	EINZUGBESCHLEUNIGER, STANDARD GESCHWINDIGKEIT
FEED RAKE DRIVE	RAFFERANTRIEB
FEEDER - PLATFORM	EINZUGSKANAL - PLATTFORM
FEEDER ACCELERATOR - STANDARD SPEED	EINZUGSKANAL BESCHLEUNIGER - STANDART GESCHWINDIGKEIT
FEEDER AUGER	EINZUGSKANAL SCHNECKE
FEEDER CHANNEL	FÖRDERTUNNEL
FEEDER CONVEYOR DRIVE	ZUFÜHRUNGSSCHNECKE ANTRIEB
FIXED SPEED FEEDER HOUSE	FIXIERTE GESCHWINDIGKEIT EINZUGSKANAL
FOR EXTENDED RANGE	FÜR WEITERTE REICHWEITE
GEAR BOX	GETRIEBE
GOVERNOR DRIVE	DREHZAHNREGELER
GRAIN CONDITIONER CPL TAFEL 31 - 37 BIG X 500	GETREIDEREINIGER CPL TAFEL 31 - 37 BIG X 500
GRAIN ELEVATOR , DRIVE	GETREIDE FÖRDERER, ANTRIEB
GRASS SEED EQUIPMENT - ACCESSORIES FOR FIXED SHOE ONLY	GRASS/SAAT ZUSATZAUSSTATTUNG - AUSRÜSTUNGSTEIL NUR FÜR FIXIERTEN VORSATZ
HEADER AND REEL PUMP (FIXED CAPACITY)	VORSATZ- UND HASPELPUMPE (FIXIERTE KAPAZITÄT)
HEADER COUNTERSHAFT TO PIVOT SHAFT	VORSATZVORLEGEWELLE - BIS PIVOT WELLE
HEAVY DUTY VERSION	HOCHLEISTUNGS VERSION
HOPPER	HOPPER
HYDRAULIC PUMP	HYDRAULIKPUMPE
HYDRAULIC REEL DRIVE	HYDRAULISCHER HASPELANTRIEB
INTENSIVE SEPARATION SYSTEM DRIVE	INTENSIVSCHÜTLER ANTRIEB
INTERMEDIATE DRIVE BLOWER	ZWISCHEN-ANTRIEB GEBLÄSE
JACKSHAFT DRIVE	VORLEGEWELLE ANTRIEB
KNIFE DRIVE	MESSERANTRIEB
MAIN DRIVE	HAUPT-ANTRIEB

GB

D

Abbreviations	Abkürzungserklärung
MAIN FAN SELECTOR - STRIPPER BEATER	HAUPT-LÜFTER SELECTOR - ABSTREIFER WENDETROMMEL
MOWER DECK	MÄH-DECK
OUTLET GRAIN	AUSLASS GETREIDE
OVERSHOT BEATER DRIVE	ÜBERSCHUB WENDETROMMEL ANTRIEB
PICK UP DRIVE	PICK UP ANTRIEB
PICK UP REEL	PICK UP HASPEL
PICKING - ATTACHMENTS DRIVE (MAIZE)	PICKING - ATTACHMENTS ANTRIEB (MAIS)
POWER STEERING	HYDROPUMPE
PROPULSION PUMP DRIVE	ANTRIEBSREGELUNG
PURIFY DRIVE	ANTRIEB AUFBEREITER
REEL DRIVE	HASPEL ANTRIEB
ROTARY DUST SCREEN DRIVE	ROTATIONS STAUBGITTER ANTRIEB
ROTARY SIEVE DRIVE	ROTATIONS SIEB ANTRIEB
SELECTOR FOR MAIN FAN	SELECTOR FÜR HAUPT-LÜFTER
SELF LEVELLING	SELBSTAUSGLEICHEND
SEPARATOR	ABSCHIEDEVORRICHTUNGS
SHAKER SHOE - 203 MEGA	SCHÜTTLER AUSLAUF - 203 MEGA
SHREDDER FAN DRIVE	SCHREDDER ANTRIEB LÜFTER
SIEVE BOX	SIEBKASTEN
SIEVE DRIVE	SIEBKASTEN ANTRIEB
SPRING LOADED DRIVE VARIATOR	FEDERBELASTETER VARIATORANTRIEB
STACKER DRIVE	STAPEL-ANTRIEB
STRAW BALER	STROH PRESSE
STRAW CHOPPER DRIVE	STROH HÄCKSLER ANTRIEB
STRAW CUTTER	STROH CUTTER
STRAW DISCHARGE	STROH ENTLADUNG
STRAW DISTRIBUTOR	STROH VERTEILER
STRAW ELEVATOR	STROH FÖRDERER
STRAW GUIDE	STROH-FÜHRUNG
STRAW SHAKER	STROH SIEBKASTEN
STRENGTHENED DRIVE	VERSTÄRKTER ANTRIEB
STRIPPER BEATER	ABSTREIFER WENDETROMMEL
SUCTION BLOWER	SAUGGEBLÄSE
TAILINGS AUGER AND ELEVATOR	ABRAUM SCHNECKE UND FÖDERER
TANDEM PUMP DRIVE	TANDEM PUMPE ANTRIEB
TANK UNLOADER DRIVE	ANTRIEB TANKENTLADUNG
THRESHING DRIVE	DRESCH-ANTRIEB
THRESHING DRUM	DRESCHTROMMEL
THROW-OUT BEATER DRIVE	AUSWURF WENDETROMMEL ANTRIEB
TILTED PLATFORM CHAMBER SHAFT	ANTRIEBSWELLE GENEIGTE PLATTFORM
TORQUE-SENSING COUNTERSHAFT DRIVE	DREHMOMENTERFASSUNG VORGELEGEWELLE ANTRIEB
TRACTION DRIVE	TRAKTION ANTRIEB
TRANSMISSION SHAFT	ÜBERTRAGUNGSWELLE
TRAVEL DRIVE	FAHRANTRIEB
TRESHING MACHINE	DRESCH-ANTRIEB
U-JOINT LOADING AUGER	KREUZGELENK SCHNECKENBELADUNG
UNKNOWN ENGINE	UNBEKANNTER MOTOR
UNLOADER DRIVE	ENTLADE-ANTRIEB
UNLOADING AUGER DRIVE	ENTLADE-SCHNECKE ANTRIEB
VARIABLE DRIVE FEEDER HOUSE, HIGH CAPACITY	VARIABLE ANTRIEB EINZUGSKANAL, HOHE KAPAZITÄT
VARIABLE SPEED FEEDER HOUSE DRIVE	REGELANTRIEBEINZUGSKANAL ANTRIEB
VARIATOR DRIVE	VARIATOR ANTRIEB
VENTILATOR	VENTILATOR
WATERPUMP DRIVE	WASSERPUMPE ANTRIEB
WHEEL SHAFT (FRONT)	RAD-WELLE (VORN)
WOBBLE BOX DRIVE	SCHÜTTLERKASTEN ANTRIEB

**OPTIBELT GmbH**  
Corveyer Allee 15  
37671 Hörter  
GERMANY

T +49 (0) 52 71-6 21  
F +49 (0) 52 71-97 6200  
E [info@optibelt.com](mailto:info@optibelt.com)

